

General Specifications

Electrical Capacity (Resistive Load)

Logic Level: 0.4VA maximum @ 28V AC/DC maximum
(Applicable Range 0.1mA ~ 0.1A @ 20mV ~ 28V)
Note: Find additional explanation of operating range in Supplement section.

Other Ratings

Contact Resistance: 50 milliohms maximum
Insulation Resistance: 500 megohms minimum @ 500V DC
Dielectric Strength: 500V AC minimum between contacts for 1 minute minimum;
500V AC minimum between contacts & case for 1 minute minimum
Mechanical Life: 100,000 operations minimum for On-None-On & On-Off-On
50,000 operations minimum for other circuits
Electrical Life: 50,000 operations minimum
Nominal Operating Force: 1.47N (momentary); 1.18N (maintained) for .394" (10.0mm) toggles
2.73N (momentary); 1.84N (maintained) for all other toggles
Contact Timing: Nonshorting (break-before-make)
Angle of Throw: 26°

Materials & Finishes

Toggle: Glass fiber reinforced polyamide for antistatic; nickel plated brass for all others
Case Housing: Glass fiber reinforced polyamide
Support Bracket: Tin plated phosphor bronze
Movable Contact: Phosphor bronze with gold plating
Stationary Contacts: Brass with gold plating
Terminals: Brass with gold plating

Environmental Data

Operating Temperature Range: -30°C through +85°C (-22°F through +185°F)
Humidity: 90 ~ 95% humidity for 240 hours @ 40°C (104°F)
Vibration: 10 ~ 55Hz with peak-to-peak amplitude of 1.5mm traversing the frequency range & returning in 1 minute; 3 right angled directions for 2 hours
Shock: 50G (490m/s²) acceleration (tested in 6 right angled directions, with 5 shocks in each direction)

PCB Processing

Soldering: Wave Soldering Recommended. See Profile A in Supplement section.
Manual Soldering: See Profile B in Supplement section.
Cleaning: Automated cleaning. See Cleaning Specifications in Supplement section.

Standards & Certifications

The A Series toggles have not been tested for UL recognition or CSA certification. These switches are designed for use in a low-voltage, low-current, logic-level circuit. When used as intended in a logic-level circuit, the results do not produce hazardous energy.

Distinctive Characteristics

Subminiature size saves space on PC boards.

Specifically developed for logic-level applications.

Totally sealed body construction prevents contact contamination and allows time- and money-saving automated soldering and cleaning.

Award-winning STC contact mechanism with benefits unavailable in conventional mechanisms: smoother, positive detent actuation, increased contact stability and unparalleled logic-level reliability. (Additional STC details in Terms & Acronyms; see Supplement contents.)

Molded-in, epoxy sealed or ultrasonically welded terminals lock out flux, solvents, and other contaminants.

.100" x .100" (2.54mm x 2.54mm) terminal spacing conforms to standard PC board grid spacing.

Toggle option in antistatic material available for dissipating electrostatic discharges.

Matching indicators available.



Actual Size



A
Toggles

Rockers

Pushbuttons

Illuminated PB

Programmable

Keylocks

Rotaries

Slides

Tactiles

Tilt

Touch

Indicators

Accessories

Supplement









TYPICAL SWITCH ORDERING EXAMPLE



DESCRIPTION FOR TYPICAL ORDERING EXAMPLE

A12JV

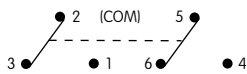

POLES & CIRCUITS								
Pole	Model	Toggle Position () = Momentary			Connected Terminals			Throw & Schematics
		Up 	Center 	Down 	Up 	Center 	Down 	
SP	A11	OFF	NONE	ON	OPEN	OPEN	3-1	SPST 
SP	A12 A13 A15 A1R A18 A19 A1S	ON ON ON (ON) (ON) ON (ON)	NONE OFF NONE NONE OFF OFF OFF	ON ON (ON) ON (ON) (ON) ON	2-3	OPEN	2-1	SPDT 
DP	A22 A23 A25 A2R A28 A29 A2S	ON ON ON (ON) (ON) ON (ON)	NONE OFF NONE NONE OFF OFF OFF	ON ON (ON) ON (ON) (ON) ON	2-3 5-6	OPEN	2-1 5-4	DPDT 

For 3 Throw (3-on)

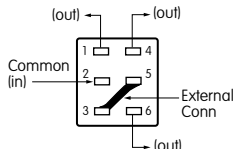
Connected Terminals & Schematics					External Connection
Pole	Model	Up	Center	Down	
SP	A24 A26 A27	ON (ON) ON	ON ON ON	ON (ON) (ON)	<p>The SP3T model utilizes a double pole base.</p> <p>External connections must be made during field installation.</p> 

TOGGLES

Standard Material & Finish: Brass with Bright Nickel Material & Finish for J2: Matte finish black glass fiber reinforced polyamide

A .394" (10.0mm) Bat

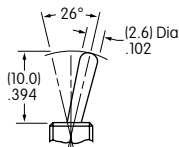

J .248" (6.3mm) Bat

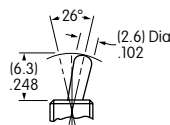

J2 .248" (6.3mm) Antistatic Bat

Dissipating 20Kv ESD: Straight PC

Dissipating 10Kv ESD: Straight PC with Bracket, Right Angle, & Vertical

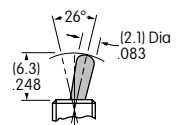

E .394" (10.0mm) Flatted

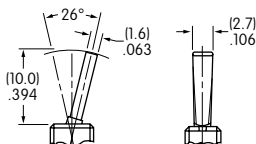

H .248" (6.3mm) Flatted

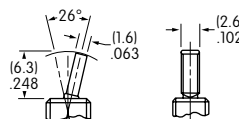

K Snap Top for Paddles

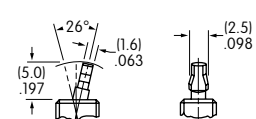

PC TERMINALS

Use of a support bracket is recommended to increase PCB mounting strength and stability.

P Straight

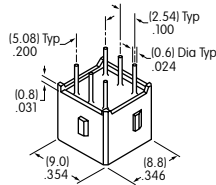

B Straight with Bracket



B1 Straight with Inline Bracket Single Pole only



H Right Angle with Bracket

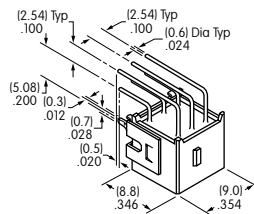

V Vertical with Bracket



V1 Vertical with Inline Bracket Single Pole only



CAPS & PADDLES

G AT4003
.394" (10.0mm) Bat Lever Cap

Material: PVC
Colors Available:
A, B, C



J AT4064
.248" (6.3mm) Bat Lever Cap

Material: PVC
Colors Available:
A, B, C



A AT467
Short Paddle

Material: Polyamide
Colors Available:
A, B, C, E, F, G, H

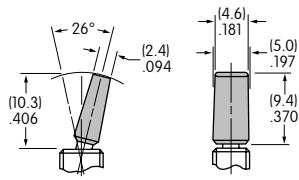

B AT468
Long Paddle

Material: Polyamide
Colors Available:
A, B, C, E, F, G, H

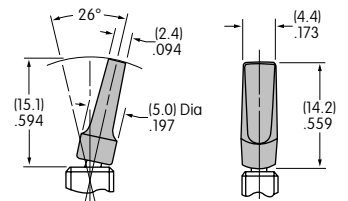

Color Codes:

- A** Black
- B** White
- C** Red
- E** Yellow
- F** Green
- G** Blue
- H** Gray

TYPICAL SWITCH DIMENSIONS

Single Pole

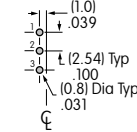
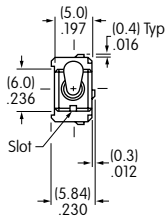

Straight PC



A11 models do not have Terminal 2

A12AP

Double Pole

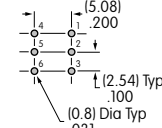

Straight PC



A22AP

Single Pole

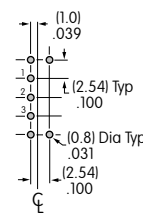
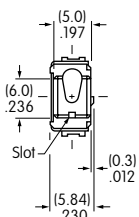

Straight PC • Bracket



B Terminals

B1 Terminals

A12AB

Double Pole

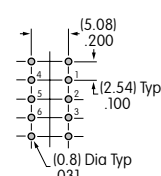
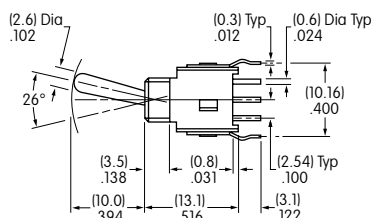

Straight PC • Bracket



A22AB

TYPICAL SWITCH DIMENSIONS

Right Angle PC

Single Pole

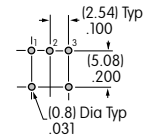
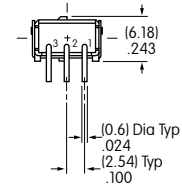
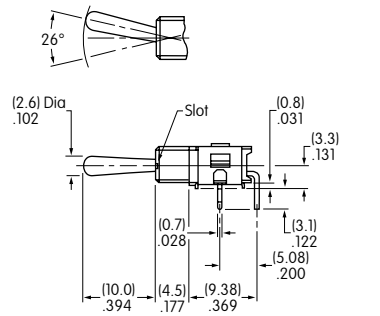
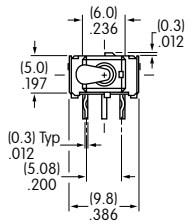

A12AH

Right Angle PC

Double Pole

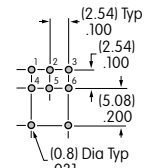
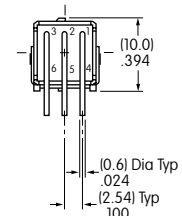
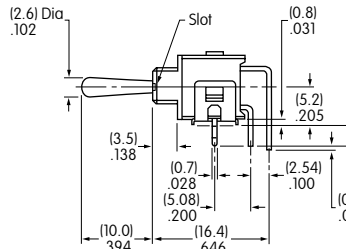

A22AH

Vertical PC

Single Pole

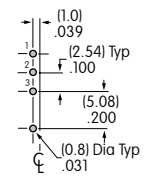
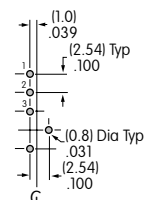
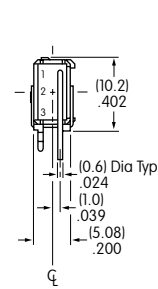
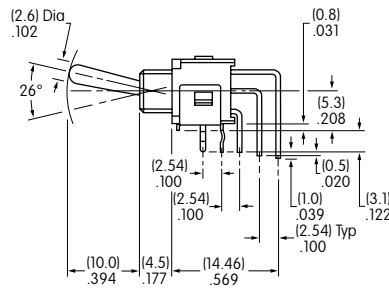
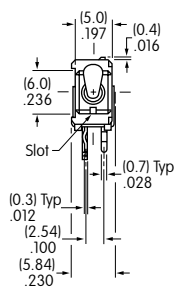

A12AV

V Terminals

V1 Terminals

Vertical PC

Double Pole

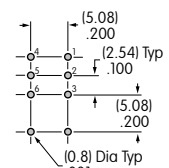
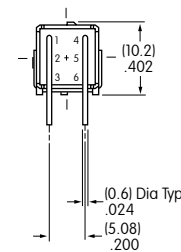
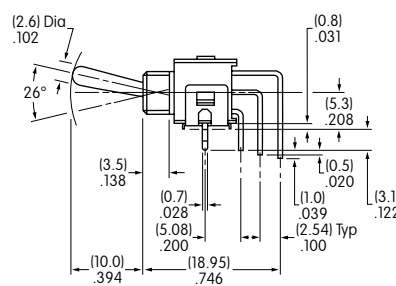
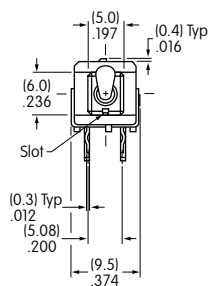

A22AV