

## Current Regulator Diodes

<b>J500</b>	<b>J503</b>	<b>J506</b>	<b>J509</b>
<b>J501</b>	<b>J504</b>	<b>J507</b>	<b>J510</b>
<b>J502</b>	<b>J505</b>	<b>J508</b>	<b>J511</b>

PRODUCT SUMMARY					
Part Number	Typ I <sub>F</sub> (mA)	P <sub>OV</sub> (V)	Part Number	Typ I <sub>F</sub> (mA)	P <sub>OV</sub> (V)
J500	0.24	50	J506	1.40	50
J501	0.33	50	J507	1.80	50
J502	0.43	50	J508	2.40	50
J503	0.56	50	J509	3.00	50
J504	0.75	50	J510	3.60	50
J505	1.00	50	J511	4.70	50

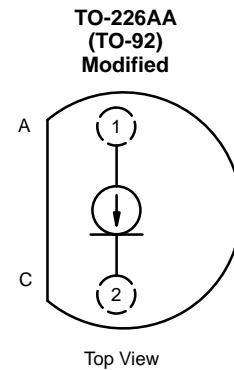

### FEATURES

- Two-Lead Plastic Package
- Guaranteed  $\pm 20\%$  Tolerance
- Operation from 1 V (J500–J503) to 50 V
- Excellent Temperature Stability

### BENEFITS

- Simple Series Circuitry, No Separate Voltage Source
- Tight Guaranteed Circuit Performance
- Excellent Performance in Low-Voltage/Battery Circuits and High-Voltage Spike Protection
- High Circuit Stability vs. Temperature

### APPLICATIONS

- Constant-Current Supply
- Current-Limiting
- Timing Circuits

### DESCRIPTION

The J500 series is a family of  $\pm 20\%$  range current regulators designed for demanding applications in test equipment and instrumentation. These devices utilize the JFET techniques to produce a single two-leaded device which is extremely simple to operate.

With nominal current ranges from 0.24 mA to 4.7 mA, the J500 series will meet a wide array of design requirements.

The low-cost TO-226A package ensures a cost-effective design solution.

### SCHEMATIC DIAGRAM

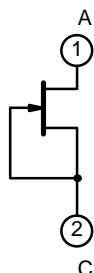

### APPLICATIONS

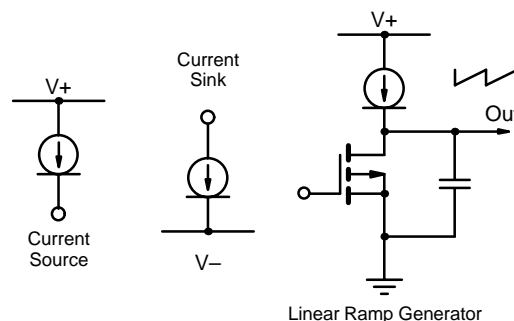

For applications information see AN103.



### ABSOLUTE MAXIMUM RATINGS

Peak Operating Voltage ..... 50 V  
 Reverse Current ..... 50 mA  
 Storage Temperature ..... -55 to 150°C

Power Dissipation<sup>a</sup> ..... 350 mW

Notes:

a. Derate 2.8 mW/°C above 25°C

SPECIFICATIONS (T <sub>A</sub> = 25°C UNLESS OTHERWISE NOTED)						
Parameter	Symbol	Test Conditions	Limits			Unit
			Min	Typ <sup>a</sup>	Max	
Peak Operating Voltage <sup>b</sup>	P <sub>OV</sub>	I <sub>F</sub> = 1.1 I <sub>F(max)</sub>	50	95		V
Reverse Voltage	V <sub>R</sub>	I <sub>R</sub> = 1 mA		0.8		
Capacitance	C <sub>F</sub>	V <sub>F</sub> = 25 V, f = 1 MHz		2.2		pF

Part Number	Regulator Current <sup>c</sup> (I <sub>F</sub> )			Dynamic Impedance <sup>d</sup> (Z <sub>d</sub> )		Knee Impedance (Z <sub>k</sub> )	Limiting Voltage <sup>e</sup> (V <sub>L</sub> )		Temperature Coefficient (θ <sub>1</sub> )
	V <sub>F</sub> = 25 V			V <sub>F</sub> = 25 V		V <sub>F</sub> = 6 V	I <sub>F</sub> = 0.8 I <sub>F(min)</sub>		V <sub>F</sub> = 25 V 0°C ≤ T <sub>A</sub> ≤ 100°C
	Min	Nom	Max	Min	Typ <sup>a</sup>	Typ <sup>a</sup>	Max	Typ <sup>a</sup>	Typ <sup>a</sup>
J500	0.192	0.24	0.288	4.00	15	2.50	1.2	0.4	0.95
J501	0.264	0.33	0.396	2.20	10	1.60	1.3	0.5	0.81
J502	0.344	0.43	0.516	1.50	7	1.10	1.5	0.6	0.70
J503	0.448	0.56	0.672	1.20	5	0.80	1.7	0.7	0.58
J504	0.600	0.75	0.900	0.80	3.5	0.55	1.9	0.8	0.46
J505	0.800	1.00	1.200	0.50	2	0.40	2.1	0.9	0.33
J506	1.120	1.40	1.680	0.33	1.5	0.25	2.5	1.1	0.19
J507	1.440	1.80	2.160	0.20	1	0.19	2.8	1.3	0.08
J508	1.900	2.40	2.900	0.20	0.7	0.13	3.1	1.5	-0.05
J509	2.400	3.00	3.600	0.15	0.5	0.09	3.5	1.7	-0.14
J510	2.900	3.60	4.300	0.15	0.4	0.07	3.9	1.9	-0.22
J511	3.800	4.70	5.600	0.12	0.3	0.05	4.2	2.1	-0.34

Notes:

- a. Typical values are for DESIGN AID ONLY, not guaranteed nor subject to production testing.
- b. Max V<sub>F</sub> where I<sub>F</sub> = 1.1 I<sub>F(max)</sub> is guaranteed.
- c. Pulse test—steady state currents may vary.
- d. Pulse test—steady state impedances may vary.
- e. Min V<sub>F</sub> required to insure I<sub>F</sub> = 0.8 I<sub>F(min)</sub>.

NCL

**TYPICAL CHARACTERISTICS ( $T_A = 25^\circ\text{C}$  UNLESS OTHERWISE NOTED)**

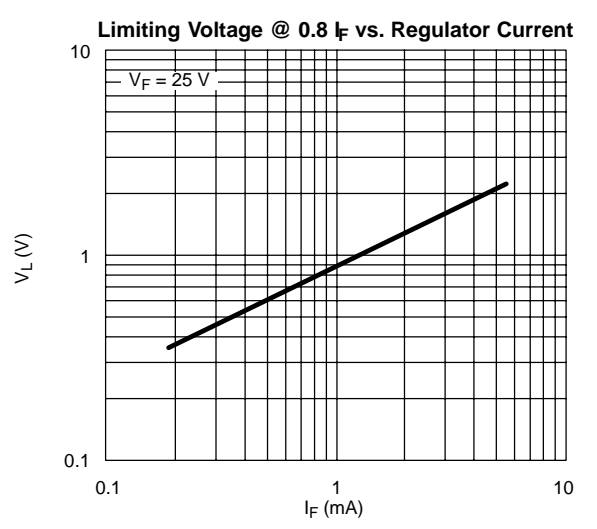
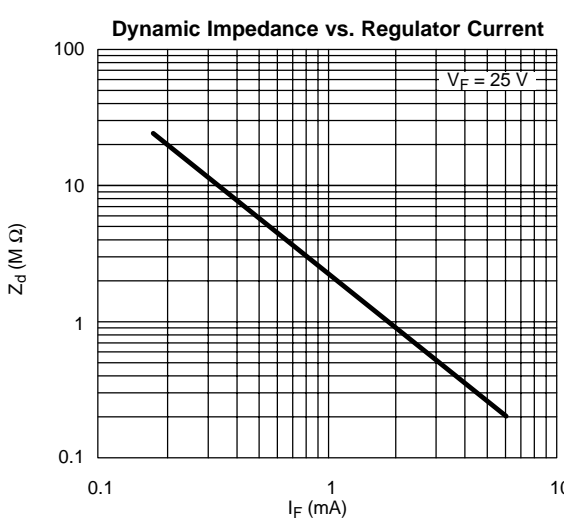
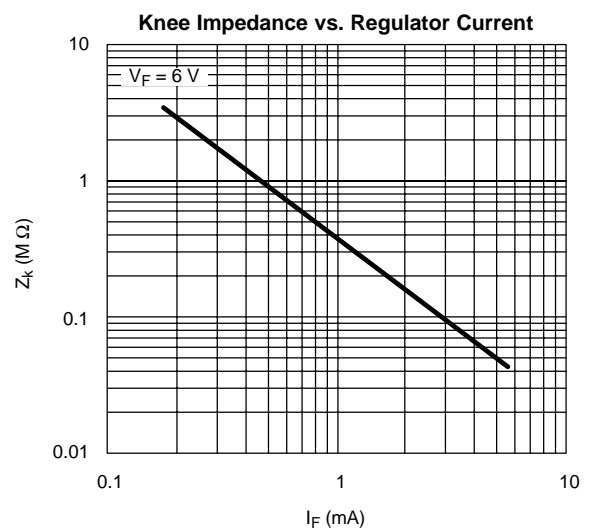
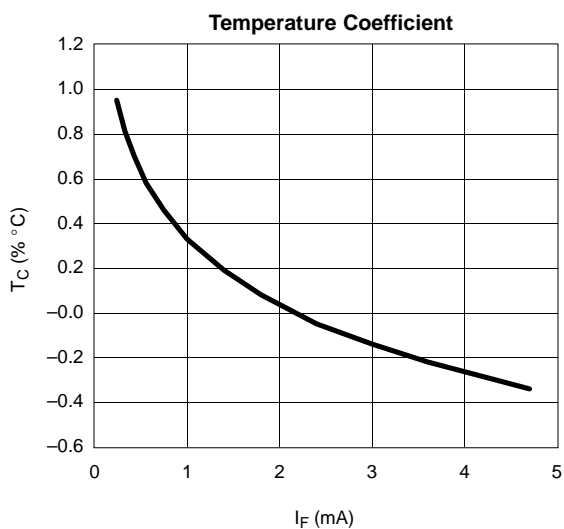
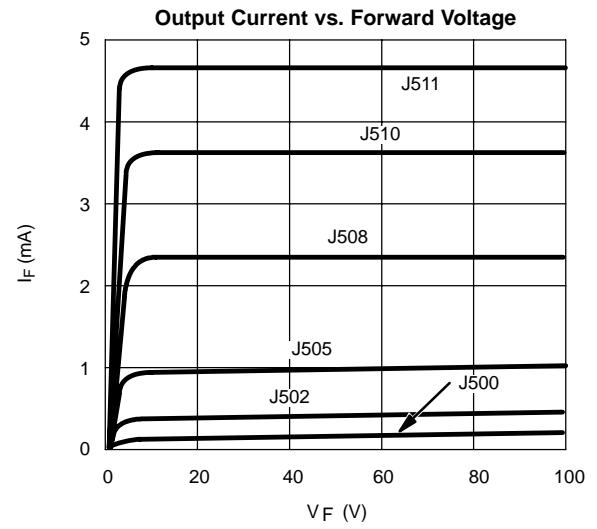
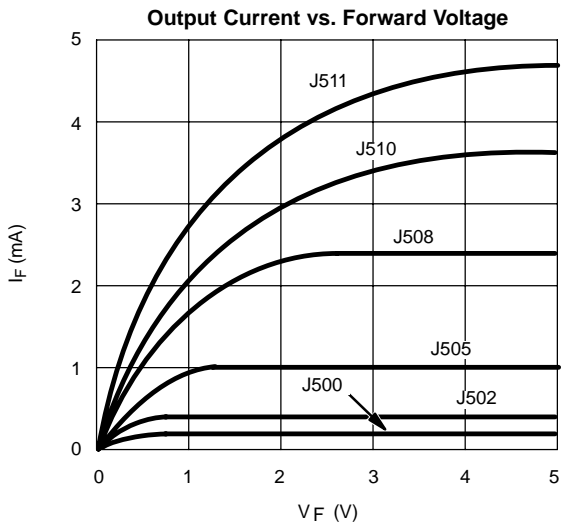

**TYPICAL CHARACTERISTICS ( $T_A = 25^\circ\text{C}$  UNLESS OTHERWISE NOTED)**

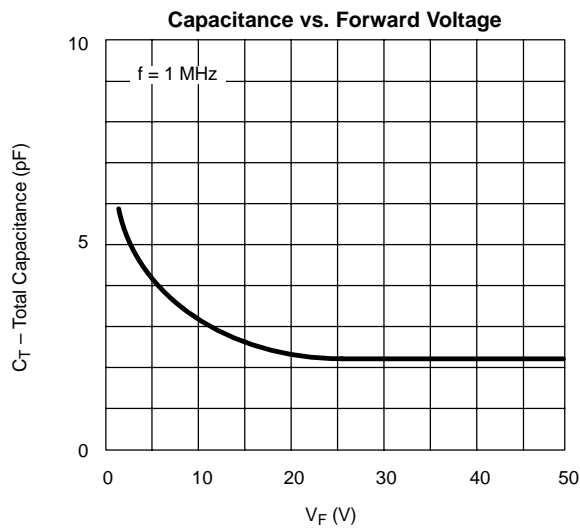
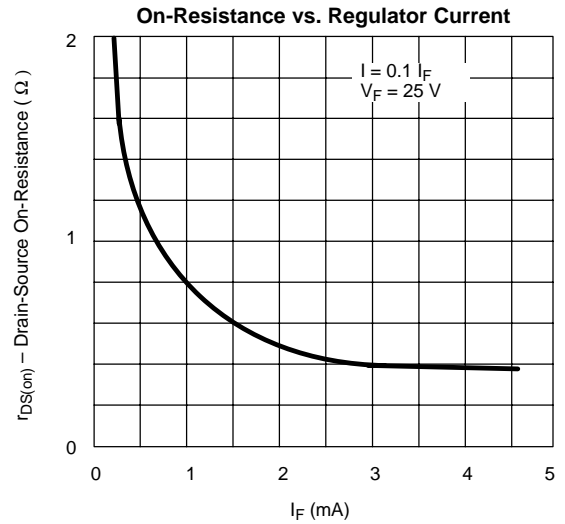
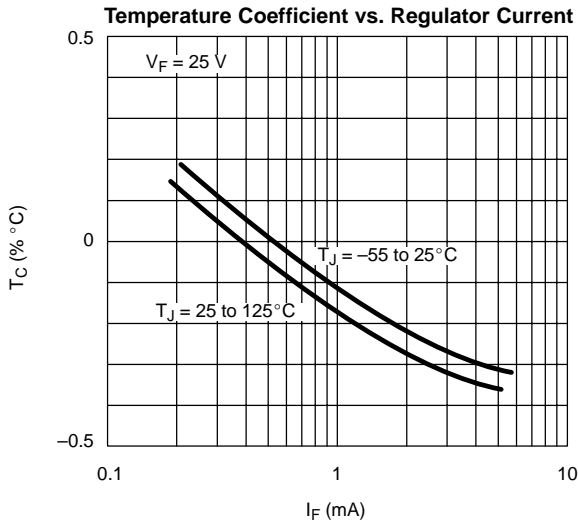

**CURRENT REGULATOR DIODE V-1 CHARACTERISTIC**

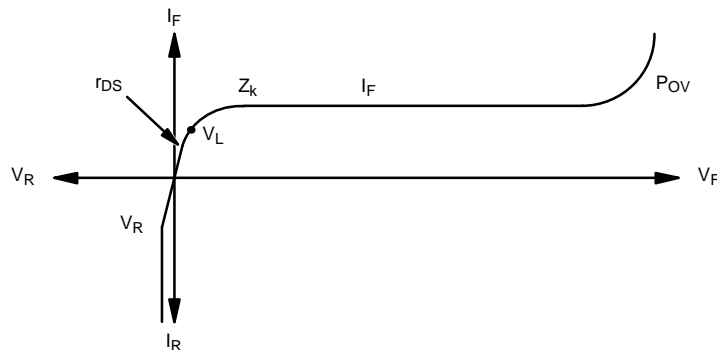



## Disclaimer

All product specifications and data are subject to change without notice.

Vishay Intertechnology, Inc., its affiliates, agents, and employees, and all persons acting on its or their behalf (collectively, "Vishay"), disclaim any and all liability for any errors, inaccuracies or incompleteness contained herein or in any other disclosure relating to any product.

Vishay disclaims any and all liability arising out of the use or application of any product described herein or of any information provided herein to the maximum extent permitted by law. The product specifications do not expand or otherwise modify Vishay's terms and conditions of purchase, including but not limited to the warranty expressed therein, which apply to these products.

No license, express or implied, by estoppel or otherwise, to any intellectual property rights is granted by this document or by any conduct of Vishay.

The products shown herein are not designed for use in medical, life-saving, or life-sustaining applications unless otherwise expressly indicated. Customers using or selling Vishay products not expressly indicated for use in such applications do so entirely at their own risk and agree to fully indemnify Vishay for any damages arising or resulting from such use or sale. Please contact authorized Vishay personnel to obtain written terms and conditions regarding products designed for such applications.

Product names and markings noted herein may be trademarks of their respective owners.