

Double Data Rate (DDR) SDRAM

MT46V128M4 – 32 Meg x 4 x 4 banks

MT46V64M8 – 16 Meg x 8 x 4 banks

MT46V32M16 – 8 Meg x 16 x 4 banks

Features

- VDD = +2.5V ±0.2V, VDDQ = +2.5V ±0.2V
- VDD = +2.6V ±0.1V, VDDQ = +2.6V ±0.1V (DDR400)
- Bidirectional data strobe (DQS) transmitted/received with data, i.e., source-synchronous data capture (x16 has two – one per byte)
- Internal, pipelined double-data-rate (DDR) architecture; two data accesses per clock cycle
- Differential clock inputs (CK and CK#)
- Commands entered on each positive CK edge
- DQS edge-aligned with data for READs; center-aligned with data for WRITEs
- DLL to align DQ and DQS transitions with CK
- Four internal banks for concurrent operation
- Data mask (DM) for masking write data (x16 has two – one per byte)
- Programmable burst lengths: 2, 4, or 8
- Auto refresh
 - 64ms, 8192-cycle (Commercial and industrial)
 - 16ms, 8192-cycle (Automotive)
- Self refresh (not available on AT devices)
- Longer-lead TSOP for improved reliability (OCPL)
- 2.5V I/O (SSTL_2 compatible)
- Concurrent auto precharge option is supported
- ^tRAS lockout supported (^tRAP = ^tRCD)

Options

- Configuration
 - 128 Meg x 4 (32 Meg x 4 x 4 banks)
 - 64 Meg x 8 (16 Meg x 8 x 4 banks)
 - 32 Meg x 16 (8 Meg x 16 x 4 banks)
- Plastic package
 - 66-pin TSOP
 - 66-pin TSOP (Pb-free)
 - 60-ball FBGA (10mm x 12.5mm)
 - 60-ball FBGA (10mm x 12.5mm) (Pb-free)
- Timing – cycle time
 - 5ns @ CL = 3 (DDR400B)
 - 6ns @ CL = 2.5 (DDR333) (FBGA only)
 - 6ns @ CL = 2.5 (DDR333) (TSOP only)
 - 7.5ns @ CL = 2 (DDR266)
 - 7.5ns @ CL = 2 (DDR266A)
 - 7.5ns @ CL = 2.5 (DDR266B)
- Self refresh
 - Standard
 - Low-power self refresh
- Temperature rating
 - Commercial (0°C to +70°C)
 - Industrial (-40°C to +85°C)
 - Automotive (-40°C to +105°C)
- Revision
 - x4, x8
 - x4, x8, x16

Marking

- 128M4
- 64M8
- 32M16
- TG
- P
- FN
- BN
- 5B
- 6
- 6T
- 75E¹
- 75Z¹
- 75¹
- None
- L
- None
- IT
- AT
- :D¹
- :F

Notes: 1. End of life.

Table 1: Key Timing Parameters

CL = CAS (READ) latency; data-out window is MIN clock rate with 50% duty cycle at CL = 2, CL = 2.5, or CL = 3

Speed Grade	Clock Rate (MHz)			Data-Out Window	Access Window	DQS-DQ Skew
	CL = 2	CL = 2.5	CL = 3			
-5B	133	167	200	1.6ns	±0.70ns	+0.40ns
-6	133	167	n/a	2.1ns	±0.70ns	+0.40ns
6T	133	167	n/a	2.0ns	±0.70ns	+0.45ns
-75E/-75Z	133	133	n/a	2.5ns	±0.75ns	+0.50ns
-75	100	133	n/a	2.5ns	±0.75ns	+0.50ns

Table 2: Addressing

Parameter	128 Meg x 4	64 Meg x 8	32 Meg x 16
Configuration	32 Meg x 4 x 4 banks	16 Meg x 8 x 4 banks	8 Meg x 16 x 4 banks
Refresh count	8K	8K	8K
Row address	8K (A0–A12)	8K (A0–A12)	8K (A0–A12)
Bank address	4 (BA0, BA1)	4 (BA0, BA1)	4 (BA0, BA1)
Column address	4K (A0–A9, A11, A12)	2K (A0–A9, A11)	1K (A0–A9)

Table 3: Speed Grade Compatibility

Marking	PC3200 (3-3-3)	PC2700 (2.5-3-3)	PC2100 (2-2-2)	PC2100 (2-3-3)	PC2100 (2.5-3-3)	PC1600 (2-2-2)
-5B ¹	Yes	Yes	Yes	Yes	Yes	Yes
-6	-	Yes	Yes	Yes	Yes	Yes
-6T	-	Yes	Yes	Yes	Yes	Yes
-75E	-	-	Yes	Yes	Yes	Yes
-75Z	-	-	-	Yes	Yes	Yes
-75	-	-	-	-	Yes	Yes
	-5B	-6/-6T	-75E	-75Z	-75	-75

Notes: 1. The -5B device is backward compatible with all slower speed grades. The voltage range of -5B device operating at slower speed grades is $V_{DD} = V_{DDQ} = 2.5V \pm 0.2V$.

Figure 1: 512Mb DDR SDRAM Part Numbers

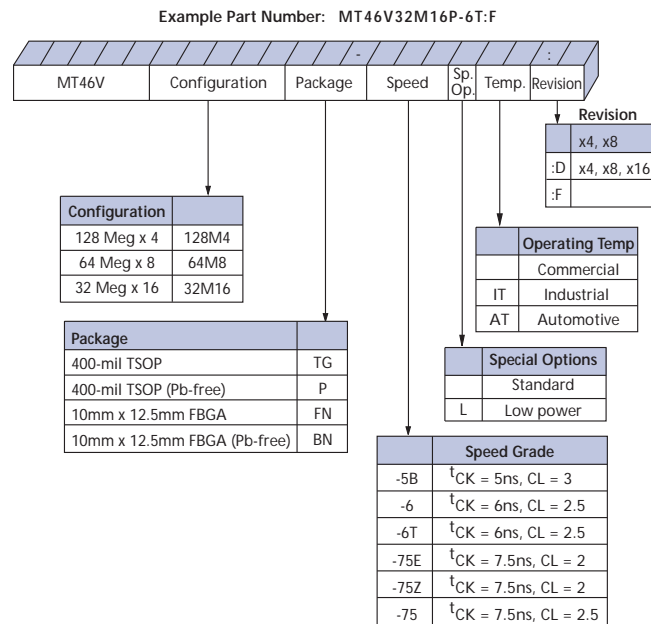

FBGA Part Number System

Due to space limitations, FBGA-packaged components have an abbreviated part marking that is different from the part number. For a quick conversion of an FBGA code, see the FBGA Part Marking Decoder on Micron's Web site: www.micron.com.

Table of Contents

State Diagram	4
Functional Description	5
General Notes	5
Automotive Temperature	6
Functional Block Diagrams	7
Pin and Ball Assignments and Descriptions	9
Package Dimensions	13
Electrical Specifications – IDD	15
Electrical Specifications – DC and AC	18
Notes	35
Commands	43
DESELECT	47
NO OPERATION (NOP)	47
LOAD MODE REGISTER (LMR)	47
ACTIVE (ACT)	48
READ	49
WRITE	50
PRECHARGE (PRE)	51
BURST TERMINATE (BST)	51
AUTO REFRESH (AR)	51
SELF REFRESH	51
Operations	52
INITIALIZATION	52
REGISTER DEFINITION	55
ACTIVE	59
READ	60
WRITE	72
PRECHARGE	85
AUTO REFRESH	87
SELF REFRESH	88
Power-down (CKE Not Active)	90

State Diagram

Figure 2: Simplified State Diagram

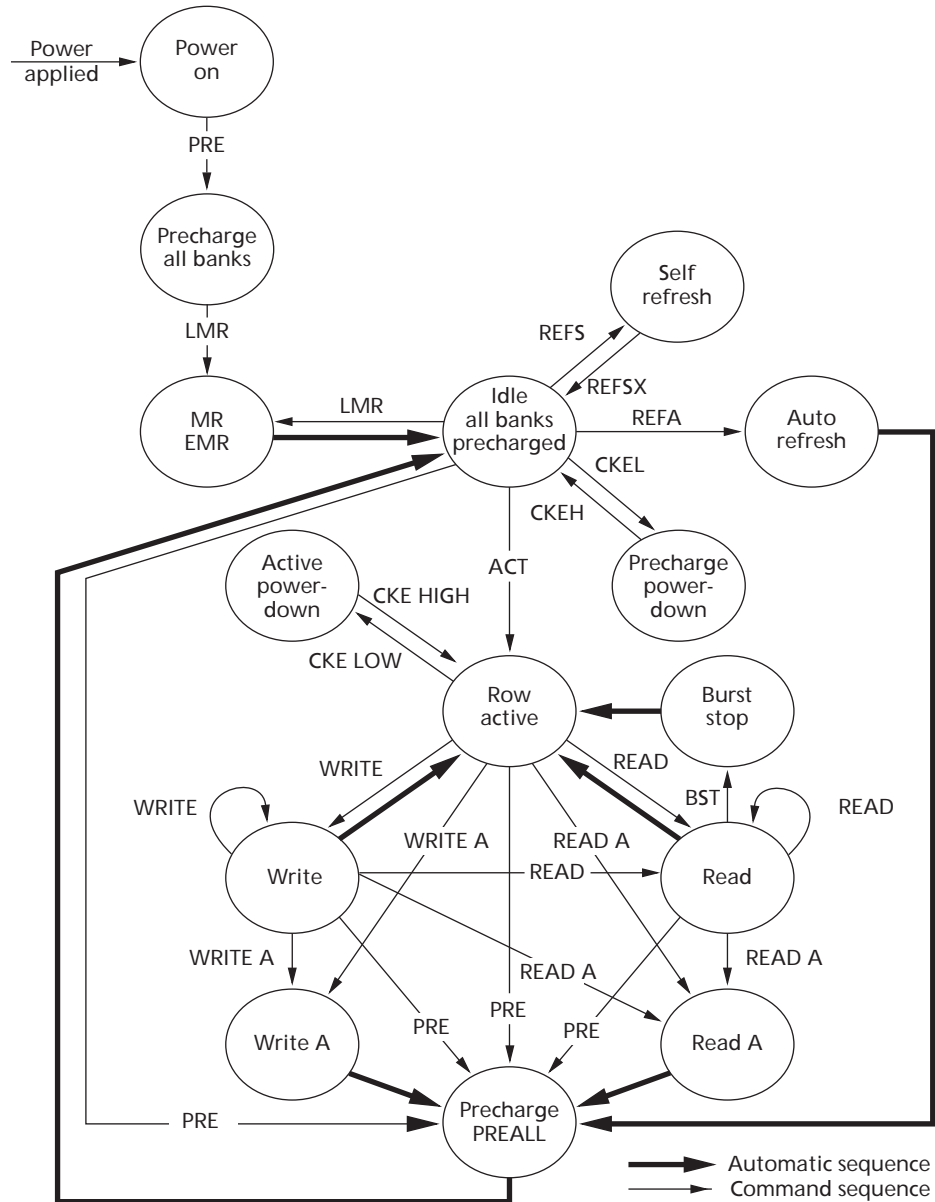

ACT = ACTIVE
 BST = BURST TERMINATE
 CKEH = Exit power-down
 CKEL = Enter power-down
 EMR = Extended mode register
 LMR = LOAD MODE REGISTER
 MR = Mode register

PRE = PRECHARGE
 PREALL = PRECHARGE all banks
 READ A = READ with auto precharge
 REFA = AUTO REFRESH
 REFS = Enter self refresh
 REFSX = Exit self refresh
 WRITE A = WRITE with auto precharge

Note: This diagram represents operations within a single bank only and does not capture concurrent operations in other banks.

Functional Description

The DDR SDRAM uses a double data rate architecture to achieve high-speed operation. The double data rate architecture is essentially a $2n$ -prefetch architecture with an interface designed to transfer two data words per clock cycle at the I/O pins. A single read or write access for the DDR SDRAM effectively consists of a single $2n$ -bit-wide, one-clock-cycle data transfer at the internal DRAM core and two corresponding n -bit-wide, one-half-clock-cycle data transfers at the I/O pins.

A bidirectional data strobe (DQS) is transmitted externally, along with data, for use in data capture at the receiver. DQS is a strobe transmitted by the DDR SDRAM during READs and by the memory controller during WRITEs. DQS is edge-aligned with data for READs and center-aligned with data for WRITEs. The x16 offering has two data strobes, one for the lower byte and one for the upper byte.

The DDR SDRAM operates from a differential clock (CK and CK#); the crossing of CK going HIGH and CK# going LOW will be referred to as the positive edge of CK. Commands (address and control signals) are registered at every positive edge of CK. Input data is registered on both edges of DQS, and output data is referenced to both edges of DQS, as well as to both edges of CK.

Read and write accesses to the DDR SDRAM are burst oriented; accesses start at a selected location and continue for a programmed number of locations in a programmed sequence. Accesses begin with the registration of an ACTIVE command, which may then be followed by a READ or WRITE command. The address bits registered coincident with the ACTIVE command are used to select the bank and row to be accessed. The address bits registered coincident with the READ or WRITE command are used to select the bank and the starting column location for the burst access.

The DDR SDRAM provides for programmable READ or WRITE burst lengths of 2, 4, or 8 locations. An auto precharge function may be enabled to provide a self-timed row precharge that is initiated at the end of the burst access.

As with standard SDR SDRAMs, the pipelined, multibank architecture of DDR SDRAMs allows for concurrent operation, thereby providing high effective bandwidth by hiding row precharge and activation time.

An auto refresh mode is provided, along with a power-saving power-down mode. All inputs are compatible with the JEDEC standard for SSTL_2. All full-drive option outputs are SSTL_2, Class II compatible.

General Notes

- The functionality and the timing specifications discussed in this data sheet are for the DLL-enabled mode of operation.
- Throughout the data sheet, the various figures and text refer to DQs as "DQ." The DQ term is to be interpreted as any and all DQ collectively, unless specifically stated otherwise. Additionally, the x16 is divided into two bytes, the lower byte and upper byte. For the lower byte (DQ0–DQ7) DM refers to LDM and DQS refers to LDQS. For the upper byte (DQ8–DQ15) DM refers to UDM and DQS refers to UDQS.
- Complete functionality is described throughout the document and any page or diagram may have been simplified to convey a topic and may not be inclusive of all requirements.
- Any specific requirement takes precedence over a general statement.

Automotive Temperature

The automotive temperature (AT) option adheres to the following specifications:

- 16ms refresh rate
- Self refresh not supported
- Ambient and case temperatures cannot be less than -40°C or greater than $+105^{\circ}\text{C}$

Figure 4: 64 Meg x 8 Functional Block Diagram

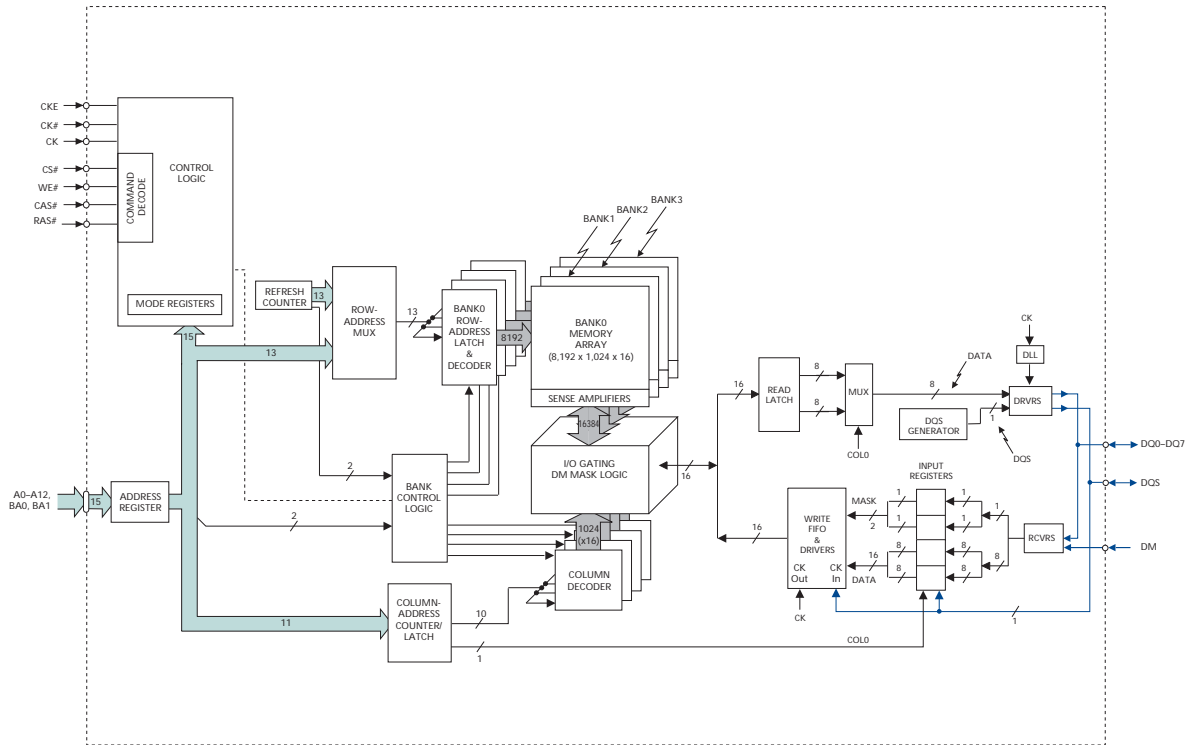
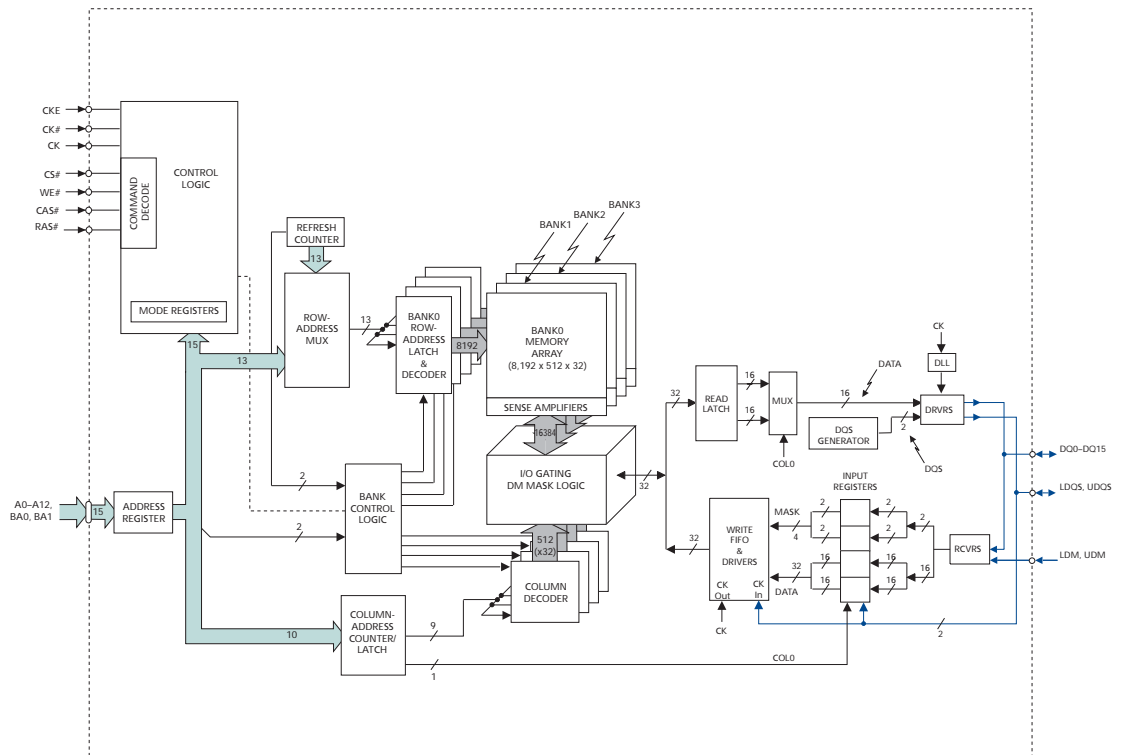

Figure 5: 32 Meg x 16 Functional Block Diagram



Pin and Ball Assignments and Descriptions

Figure 6: 66-Pin TSOP Pin Assignment (Top View)

x4	x8	x16				x16	x8	x4
V _{DD}	V _{DD}	V _{DD}	□	1 •	66	□	V _{SS}	V _{SS}
NF	DQ0	DQ0	□	2	65	□	DQ15	DQ7
V _{DDQ}	V _{DDQ}	V _{DDQ}	□	3	64	□	V _{SSQ}	V _{SSQ}
NC	NC	DQ1	□	4	63	□	DQ14	NC
DQ0	DQ1	DQ2	□	5	62	□	DQ13	DQ6
V _{SSQ}	V _{SSQ}	V _{SSQ}	□	6	61	□	V _{DDQ}	V _{DDQ}
NC	NC	DQ3	□	7	60	□	DQ12	NC
NF	DQ2	DQ4	□	8	59	□	DQ11	DQ5
V _{DDQ}	V _{DDQ}	V _{DDQ}	□	9	58	□	V _{SSQ}	V _{SSQ}
NC	NC	DQ5	□	10	57	□	DQ10	NC
DQ1	DQ3	DQ6	□	11	56	□	DQ9	DQ4
V _{SSQ}	V _{SSQ}	V _{SSQ}	□	12	55	□	V _{DDQ}	V _{DDQ}
NC	NC	DQ7	□	13	54	□	DQ8	NC
NC	NC	NC	□	14	53	□	NC	NC
V _{DDQ}	V _{DDQ}	V _{DDQ}	□	15	52	□	V _{SSQ}	V _{SSQ}
NC	NC	LDQS	□	16	51	□	UDQS	DQS
NC	NC	NC	□	17	50	□	DNU	DNU
V _{DD}	V _{DD}	V _{DD}	□	18	49	□	V _{REF}	V _{REF}
DNU	DNU	DNU	□	19	48	□	V _{SS}	V _{SS}
NC	NC	LDM	□	20	47	□	UDM	DM
WE#	WE#	WE#	□	21	46	□	CK#	CK#
CAS#	CAS#	CAS#	□	22	45	□	CK	CK
RAS#	RAS#	RAS#	□	23	44	□	CKE	CKE
CS#	CS#	CS#	□	24	43	□	NC	NC
NC	NC	NC	□	25	42	□	A12	A12
BA0	BA0	BA0	□	26	41	□	A11	A11
BA1	BA1	BA1	□	27	40	□	A9	A9
A10/AP	A10/AP	A10/AP	□	28	39	□	A8	A8
A0	A0	A0	□	29	38	□	A7	A7
A1	A1	A1	□	30	37	□	A6	A6
A2	A2	A2	□	31	36	□	A5	A5
A3	A3	A3	□	32	35	□	A4	A4
V _{DD}	V _{DD}	V _{DD}	□	33	34	□	V _{SS}	V _{SS}

Figure 7: 60-Ball FBGA Ball Assignment (Top View)

x4 (Top View)

1	2	3	4	5	6	7	8	9
VssQ	NF	Vss	● A ●			VDD	NF	VDDQ
NC	VDDQ	DQ3	● B ●			DQ0	VssQ	NC
NC	VssQ	NF	● C ●			NF	VDDQ	NC
NC	VDDQ	DQ2	● D ●			DQ1	VssQ	NC
NC	VssQ	DQS	● E ●			NC	VDDQ	NC
VREF	Vss	DM	● F ●			NC	VDD	DNU
	CK	CK#	● G ●			WE#	CAS#	
	A12	CKE	● H ●			RAS#	CS#	
	A11	A9	● J ●			BA1	BA0	
	A8	A7	● K ●			A0	A10	
	A6	A5	● L ●			A2	A1	
	A4	Vss	● M ●			VDD	A3	

x8 (Top View)

1	2	3	4	5	6	7	8	9
VssQ	DQ7	Vss	● A ●			VDD	DQ0	VDDQ
NC	VDDQ	DQ6	● B ●			DQ1	VssQ	NC
NC	VssQ	DQ5	● C ●			DQ2	VDDQ	NC
NC	VDDQ	DQ4	● D ●			DQ3	VssQ	NC
NC	VssQ	DQS	● E ●			NC	VDDQ	NC
VREF	Vss	DM	● F ●			NC	VDD	DNU
	CK	CK#	● G ●			WE#	CAS#	
	A12	CKE	● H ●			RAS#	CS#	
	A11	A9	● J ●			BA1	BA0	
	A8	A7	● K ●			A0	A10	
	A6	A5	● L ●			A2	A1	
	A4	Vss	● M ●			VDD	A3	

x16 (Top View)

1	2	3	4	5	6	7	8	9
VssQ	DQ15	Vss	● A ●			VDD	DQ0	VDDQ
DQ14	VDDQ	DQ13	● B ●			DQ2	VssQ	DQ1
DQ12	VssQ	DQ11	● C ●			DQ4	VDDQ	DQ3
DQ10	VDDQ	DQ9	● D ●			DQ6	VssQ	DQ5
DQ8	VssQ	UDQS	● E ●			LDQS	VDDQ	DQ7
VREF	Vss	UDM	● F ●			LDM	VDD	DNU
	CK	CK#	● G ●			WE#	CAS#	
	A12	CKE	● H ●			RAS#	CS#	
	A11	A9	● J ●			BA1	BA0	
	A8	A7	● K ●			A0	A10	
	A6	A5	● L ●			A2	A1	
	A4	Vss	● M ●			VDD	A3	

Table 4: Pin and Ball Descriptions

FPGA Numbers	TSOP Numbers	Symbol	Type	Description
K7, L8, L7, M8, M2, L3, L2, K3, K2, J3, K8, J2, H2	29, 30, 31, 32, 35, 36, 37, 38, 39, 40, 28 41, 42	A0, A1, A2, A3, A4, A5, A6, A7, A8, A9, A10, A11, A12	Input	Address inputs: Provide the row address for ACTIVE commands, and the column address and auto precharge bit (A10) for READ/WRITE commands, to select one location out of the memory array in the respective bank. A10 sampled during a PRECHARGE command determines whether the PRECHARGE applies to one bank (A10 LOW, bank selected by BA0, BA1) or all banks (A10 HIGH). The address inputs also provide the op-code during a LOAD MODE REGISTER command.
J8, J7	26, 27	BA0, BA1	Input	Bank address inputs: BA0 and BA1 define to which bank an ACTIVE, READ, WRITE, or PRECHARGE command is being applied. BA0 and BA1 also define which mode register (mode register or extended mode register) is loaded during the LOAD MODE REGISTER (LMR) command.
G2, G3	45, 46	CK, CK#	Input	Clock: CK and CK# are differential clock inputs. All address and control input signals are sampled on the crossing of the positive edge of CK and negative edge of CK#. Output data (DQ and DQS) is referenced to the crossings of CK and CK#.
H3	44	CKE	Input	Clock enable: CKE HIGH activates and CKE LOW deactivates the internal clock, input buffers, and output drivers. Taking CKE LOW provides PRECHARGE POWER-DOWN and SELF REFRESH operations (all banks idle), or ACTIVE POWER-DOWN (row ACTIVE in any bank). CKE is synchronous for POWER-DOWN entry and exit, and for SELF REFRESH entry. CKE is asynchronous for SELF REFRESH exit and for disabling the outputs. CKE must be maintained HIGH throughout read and write accesses. Input buffers (excluding CK, CK#, and CKE) are disabled during POWER-DOWN. Input buffers (excluding CKE) are disabled during SELF REFRESH. CKE is an SSTL_2 input but will detect an LVCMOS LOW level after V _{DD} is applied and until CKE is first brought HIGH, after which it becomes a SSTL_2 input only.
H8	24	CS#	Input	Chip select: CS# enables (registered LOW) and disables (registered HIGH) the command decoder. All commands are masked when CS# is registered HIGH. CS# provides for external bank selection on systems with multiple banks. CS# is considered part of the command code.
F3 F7, F3	47 20,47	DM LDM, UDM	Input	Input data mask: DM is an input mask signal for write data. Input data is masked when DM is sampled HIGH along with that input data during a write access. DM is sampled on both edges of DQS. Although DM pins are input-only, the DM loading is designed to match that of DQ and DQS pins. For the x16, LDM is DM for DQ0–DQ7 and UDM is DM for DQ8–DQ15. Pin 20 is a NC on x4 and x8.
H7, G8, G7	23, 22, 21	RAS#, CAS#, WE#	Input	Command inputs: RAS#, CAS#, and WE# (along with CS#) define the command being entered.
A8, B9, B7, C9, C7, D9, D7, E9, E1, D3, D1, C3, C1, B3, B1, A2	2, 4, 5, 7, 8, 10, 11, 13, 54, 56, 57, 59, 60, 62, 63, 65	DQ0–DQ2 DQ3–DQ5 DQ6–DQ8 DQ9–DQ11 DQ12–DQ14 DQ15	I/O	Data input/output: Data bus for x16.
A8, B7, C7, D7, D3, C3, B3, A2	2, 5, 8, 11, 56, 59, 62, 65	DQ0–DQ2 DQ3–DQ5 DQ6, DQ7	I/O	Data input/output: Data bus for x8.
B7, D7, D3, B3	5, 11, 56, 62	DQ0–DQ2 DQ3	I/O	Data input/output: Data bus for x4.

Table 4: Pin and Ball Descriptions (continued)

FBGA Numbers	TSOP Numbers	Symbol	Type	Description
E3 E7 E3	51 16 51	DQS LDQS UDQS	I/O	Data strobe: Output with read data, input with write data. DQS is edge-aligned with read data, centered in write data. It is used to capture data. For the x16, LDQS is DQS for DQ0–DQ7 and UDQS is DQS for DQ8–DQ15. Pin 16 (E7) is NC on x4 and x8.
F8, M7, A7	1, 18, 33	VDD	Supply	Power supply: +2.5V ±0.2V. (+2.6V ±0.1V for DDR400).
B2, D2, C8, E8, A9	3, 9, 15, 55, 61	VDDQ	Supply	DQ power supply: +2.5V ±0.2V (+2.6V ±0.1V for DDR400). Isolated on the die for improved noise immunity.
F1	49	VREF	Supply	SSTL_2 reference voltage.
A3, F2, M3	34, 48, 66	VSS	Supply	Ground.
A1, C2, E2, B8, D8	6, 12, 52, 58, 64	VSSQ	Supply	DQ ground: Isolated on the die for improved noise immunity.
–	14, 17, 25, 43, 53	NC	–	No connect for x16: These pins should be left unconnected.
B1, B9, C1, C9, D1, D9, E1, E7, E9, F7	4, 7, 10, 13, 14, 16, 17, 20, 25, 43, 53, 54, 57, 60, 63	NC	–	No connect for x8: These pins should be left unconnected.
B1, B9, C1, C9, D1, D9, E1, E7, E9, F7	4, 7, 10, 13, 14, 16, 17, 20, 25, 43, 53, 54, 57, 60, 63	NC	–	No connect for x4: These pins should be left unconnected.
A2, A8, C3, C7	2, 8, 59, 65	NF	–	No function for x4: These pins should be left unconnected.
F9	19, 50	DNU	–	Do not use: Must float to minimize noise on VREF.

Table 5: Reserved NC Pin and Ball Descriptions

NC pins not listed may also be reserved for other uses; this table defines NC pins of importance

TSOP Numbers	Symbol	Type	Description
17	A13	Input	Address input A13 for 1Gb devices.

Package Dimensions

Figure 8: 66-Pin Plastic TSOP (400 mil)

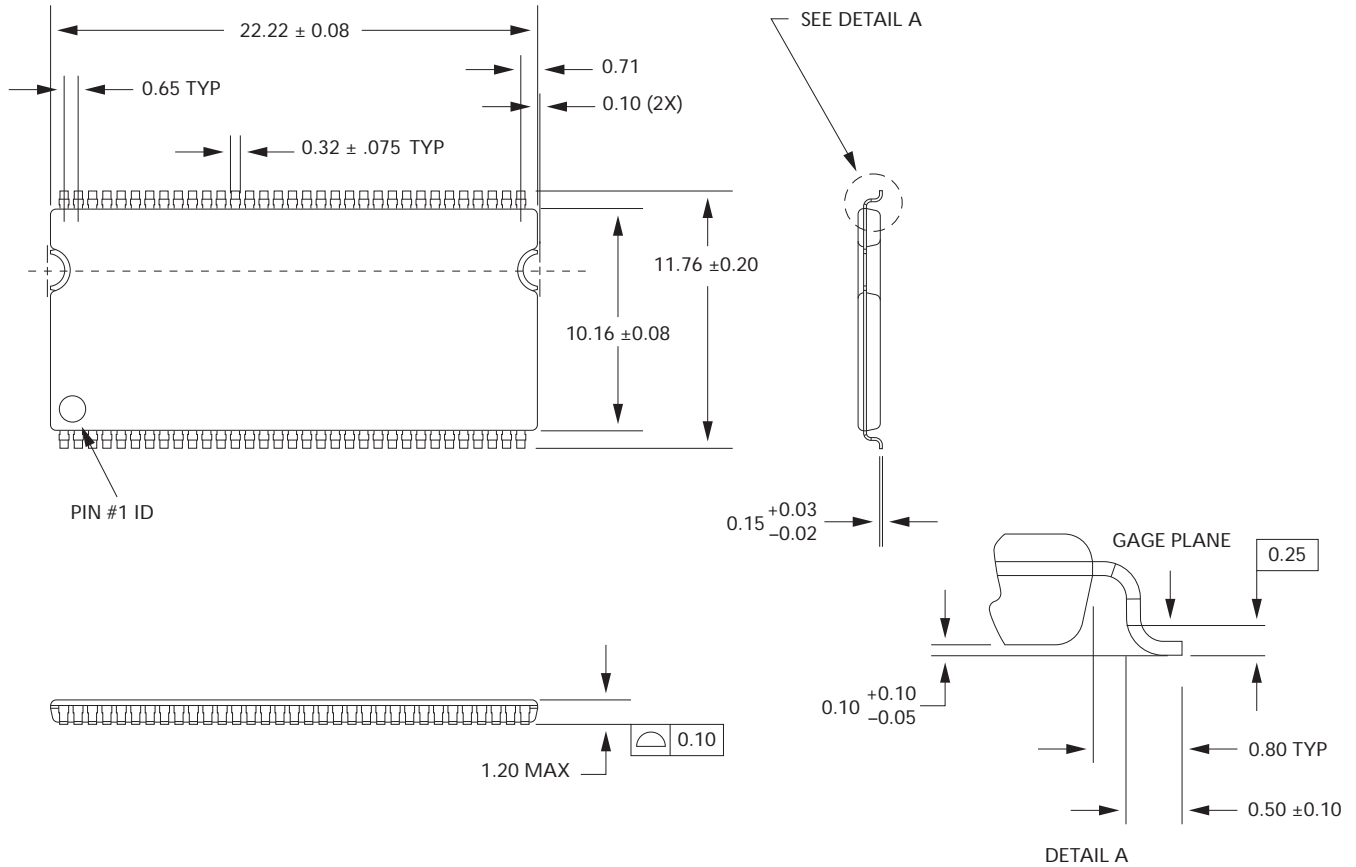

- Notes:
1. All dimensions are in millimeters.
 2. Package width and length do not include mold protrusion; allowable mold protrusion is 0.25mm per side.
 3. Not all packages will have the half moon shaped notches as shown.

Figure 9: 60-Ball FBGA (10mm x 12.5mm)

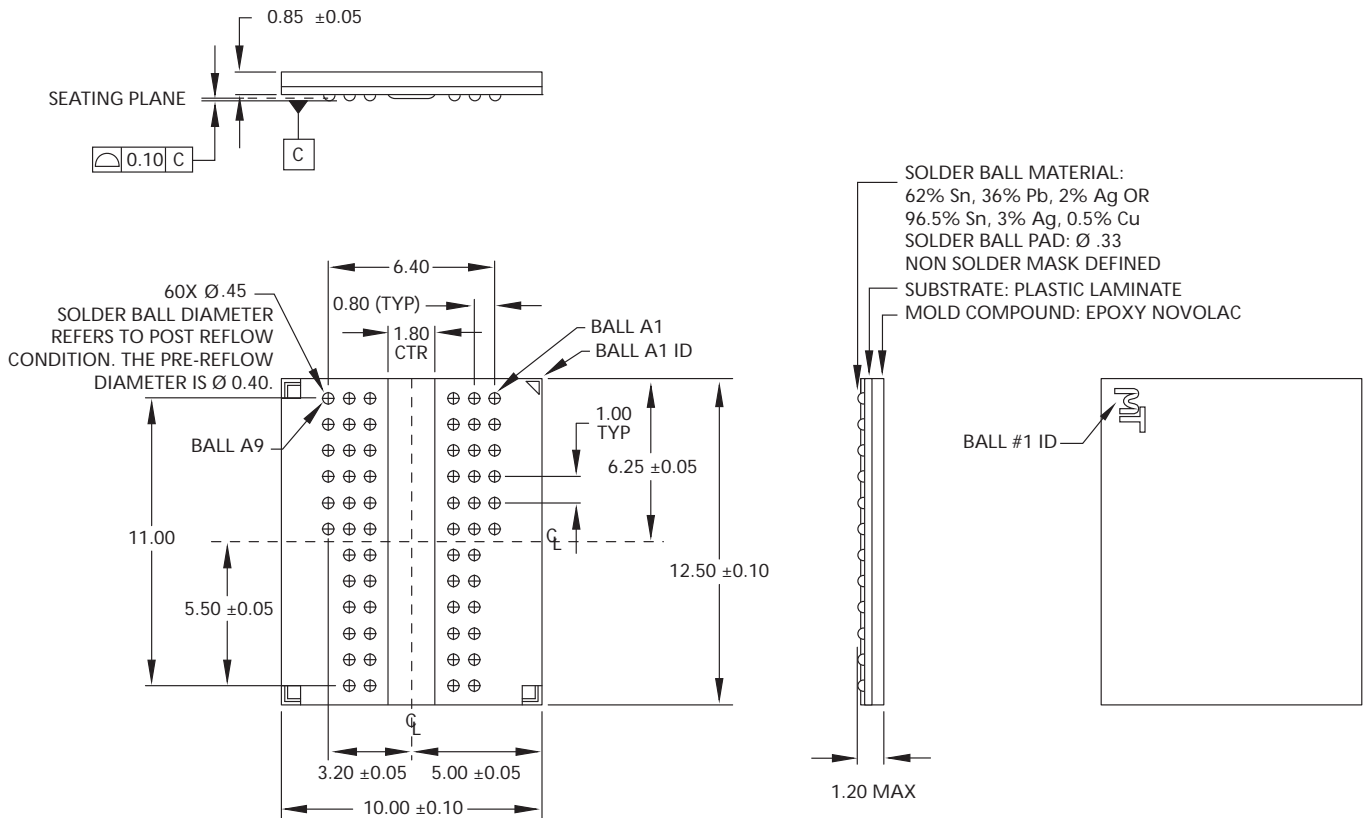

- Notes:
1. All dimensions are in millimeters.
 2. Topside part marking decoder can be found on Micron's Web site.

Electrical Specifications - IDD

Table 6: IDD Specifications and Conditions (x4, x8)

V_{DDQ} = +2.6V ±0.1V, V_{DD} = +2.6V ±0.1V (-5B); V_{DDQ} = +2.5V ±0.2V, V_{DD} = +2.5V ±0.2V (-6, -6T, -75E, -75Z, -75);
 0°C ≤ T_A ≤ +70°C; Notes: 1-5, 11, 13, 15, 47; Notes appear on pages 35-40; See also Table 8 on page 17

Parameter/Condition	Symbol	-5B	-6/6T	-75E	-75Z/-75	Units	Notes	
Operating one-bank active-precharge current: t _{RC} = t _{RC} (MIN); t _{CK} = t _{CK} (MIN); DQ, DM, and DQS inputs changing once per clock cycle; Address and control inputs changing once every two clock cycles	I _{DD0}	155	130	130	115	mA	23, 48	
Operating one-bank active-read-precharge current: Burst = 4; t _{RC} = t _{RC} (MIN); t _{CK} = t _{CK} (MIN); I _{OUT} = 0mA; Address and control inputs changing once per clock cycle	I _{DD1}	185	160	160	145	mA	23, 48	
Precharge power-down standby current: All banks idle; Power-down mode; t _{CK} = t _{CK} (MIN); CKE = (LOW)	I _{DD2P}	5	5	5	5	mA	24, 33	
Idle standby current: CS# = HIGH; All banks are idle; t _{CK} = t _{CK} (MIN); CKE = HIGH; Address and other control inputs changing once per clock cycle; V _{IN} = V _{REF} for DQ, DQS, and DM	I _{DD2F}	55	45	45	40	mA	51	
Active power-down standby current: One bank active; Power-down mode; t _{CK} = t _{CK} (MIN); CKE = LOW	I _{DD3P}	45	35	35	30	mA	24, 33	
Active standby current: CS# = HIGH; CKE = HIGH; One bank active; t _{RC} = t _{RAS} (MAX); t _{CK} = t _{CK} (MIN); DQ, DM, and DQS inputs changing twice per clock cycle; Address and other control inputs changing once per clock cycle	I _{DD3N}	60	50	50	45	mA	23	
Operating burst read current: Burst = 2; Continuous burst reads; One bank active; Address and control inputs changing once per clock cycle; t _{CK} = t _{CK} (MIN); I _{OUT} = 0mA	I _{DD4R}	190	165	165	145	mA	23, 48	
Operating burst write current: Burst = 2; Continuous burst writes; One bank active; Address and control inputs changing once per clock cycle; t _{CK} = t _{CK} (MIN); DQ, DM, and DQS inputs changing twice per clock cycle	I _{DD4W}	195	175	155	135	mA	23	
Auto refresh burst current:	t _{RFC} = t _{RFC} (MIN)	I _{DD5}	345	290	290	280	mA	50
	t _{RFC} = 7.8μs	I _{DD5A}	11	10	10	10	mA	28, 50
	t _{RFC} = 1.95μs (AT)	I _{DD5A}	16	15	15	15	mA	28, 50
Self refresh current: CKE ≤ 0.2V	Standard	I _{DD6}	5	5	5	5	mA	12
	Low power (L)	I _{DD6A}	3	3	3	3	mA	12
Operating bank interleave read current: Four bank interleaving READs (burst = 4) with auto precharge, t _{RC} = minimum t _{RC} allowed; t _{CK} = t _{CK} (MIN); Address and control inputs change only during active READ or WRITE commands	I _{DD7}	450	405	400	350	mA	23, 49	

Table 7: IDD Specifications and Conditions (x16)

VDDQ = +2.6V ±0.1V, VDD = +2.6V ±0.1V (-5B); VDDQ = +2.5V ±0.2V, VDD = +2.5V ±0.2V (-6, -6T, -75E, -75Z, -75);
 0°C ≤ T_A ≤ +70°C; Notes: 1–5, 11, 13, 15, 47; Notes appear on pages 35–40; See also Table 8 on page 17

Parameter/Condition	Symbol	-5B	-6/6T	-75E	-75Z/-75	Units	Notes	
Operating one-bank active-precharge current: t _{RC} = t _{RC} (MIN); t _{CK} = t _{CK} (MIN); DQ, DM, and DQS inputs changing once per clock cycle; Address and control inputs changing once every two clock cycles	IDD0	155	130	130	115	mA	23, 48	
Operating one-bank active-read-precharge current: Burst = 4; t _{RC} = t _{RC} (MIN); t _{CK} = t _{CK} (MIN); I _{OUT} = 0mA; Address and control inputs changing once per clock cycle	IDD1	195	160	160	145	mA	23, 48	
Precharge power-down standby current: All banks idle; Power-down mode; t _{CK} = t _{CK} (MIN); CKE = (LOW)	IDD2P	5	5	5	5	mA	24, 33	
Idle standby current: CS# = HIGH; All banks are idle; t _{CK} = t _{CK} (MIN); CKE = HIGH; Address and other control inputs changing once per clock cycle; V _{IN} = V _{REF} for DQ, DQS, and DM	IDD2F	55	45	45	40	mA	51	
Active power-down standby current: One bank active; Power-down mode; t _{CK} = t _{CK} (MIN); CKE = LOW	IDD3P	45	35	35	30	mA	24, 33	
Active standby current: CS# = HIGH; CKE = HIGH; One bank active; t _{RC} = t _{RAS} (MAX); t _{CK} = t _{CK} (MIN); DQ, DM, and DQS inputs changing twice per clock cycle; Address and other control inputs changing once per clock cycle	IDD3N	60	50	50	45	mA	23	
Operating burst read current: Burst = 2; Continuous burst reads; One bank active; Address and control inputs changing once per clock cycle; t _{CK} = t _{CK} (MIN); I _{OUT} = 0mA	IDD4R	210	165	165	145	mA	23, 48	
Operating burst write current: Burst = 2; Continuous burst writes; One bank active; Address and control inputs changing once per clock cycle; t _{CK} = t _{CK} (MIN); DQ, DM, and DQS inputs changing twice per clock cycle	IDD4W	215	195	160	135	mA	23	
Auto refresh burst current:	t _{RFC} = t _{RFC} (MIN)	IDD5	345	290	290	280	mA	50
	t _{RFC} = 7.8μs	IDD5A	11	10	10	10	mA	28, 50
	t _{RFC} = 1.95μs (AT)	IDD5A	16	15	15	15	mA	28, 50
Self refresh current: CKE ≤ 0.2V	Standard	IDD6	6	5	5	5	mA	12
	Low power (L)	IDD6A	4	3	3	3	mA	12
Operating bank interleave read current: Four bank interleaving READs (burst = 4) with auto precharge, t _{RC} = minimum t _{RC} allowed; t _{CK} = t _{CK} (MIN); Address and control inputs change only during active READ or WRITE commands	IDD7	480	405	400	350	mA	23, 49	

Table 8: IDD Test Cycle Times
 Values reflect number of clock cycles for each test

IDD Test	Speed Grade	Clock Cycle Time	t _{RRD}	t _{RCD}	t _{RAS}	t _{RP}	t _{RC}	t _{RFC}	t _{REFI}	CL
IDD0	-75/75Z	7.5ns	n/a	n/a	6	3	9	n/a	n/a	n/a
	-75E	7.5ns	n/a	n/a	6	2	8	n/a	n/a	n/a
	-6/-6T	6ns	n/a	n/a	7	3	10	n/a	n/a	n/a
	-5B	5ns	n/a	n/a	8	3	11	n/a	n/a	n/a
IDD1	-75	7.5ns	n/a	n/a	6	3	9	n/a	n/a	2.5
	-75Z	7.5ns	n/a	n/a	6	3	9	n/a	n/a	2
	-75E	7.5ns	n/a	n/a	6	2	8	n/a	n/a	2
	-6/-6T	6ns	n/a	n/a	7	3	10	n/a	n/a	2.5
	-5B	5ns	n/a	n/a	n/a	n/a	n/a	n/a	n/a	3
IDD4R	-75	7.5ns	n/a	n/a	n/a	n/a	n/a	n/a	n/a	2.5
	-75Z	7.5ns	n/a	n/a	n/a	n/a	n/a	n/a	n/a	2
	-75E	7.5ns	n/a	n/a	n/a	n/a	n/a	n/a	n/a	2
	-6/-6T	6ns	n/a	n/a	n/a	n/a	n/a	n/a	n/a	2.5
	-5B	5ns	n/a	n/a	n/a	n/a	n/a	n/a	n/a	3
IDD4W	-75	7.5ns	n/a	n/a	n/a	n/a	n/a	n/a	n/a	n/a
	-75Z	7.5ns	n/a	n/a	n/a	n/a	n/a	n/a	n/a	n/a
	-75E	7.5ns	n/a	n/a	n/a	n/a	n/a	n/a	n/a	n/a
	-6/-6T	6ns	n/a	n/a	n/a	n/a	n/a	n/a	n/a	n/a
	-5B	5ns	n/a	n/a	n/a	n/a	n/a	n/a	n/a	n/a
IDD5	-75/75Z	7.5ns	n/a	n/a	n/a	n/a	n/a	10	10	n/a
	-75E	7.5ns	n/a	n/a	n/a	n/a	n/a	9	9	n/a
	-6/-6T	6ns	n/a	n/a	n/a	n/a	n/a	12	12	n/a
	-5B	5ns	n/a	n/a	n/a	n/a	n/a	14	14	n/a
IDD5A	-75/75Z	7.5ns	n/a	n/a	n/a	n/a	n/a	10	1,029	n/a
	-75E	7.5ns	n/a	n/a	n/a	n/a	n/a	10	1,029	n/a
	-6/-6T	6ns	n/a	n/a	n/a	n/a	n/a	12	1,288	n/a
	-5B	5ns	n/a	n/a	n/a	n/a	n/a	14	1,546	n/a
IDD7	-75	7.5ns	2	3	n/a	3	10	n/a	n/a	2.5
	-75Z	7.5ns	2	3	n/a	3	10	n/a	n/a	2
	-75E	7.5ns	2	3	n/a	2	8	n/a	n/a	2
	-6/-6T	6ns	2	3	n/a	3	10	n/a	n/a	2.5
	-5B	5ns	2	3	n/a	3	11	n/a	n/a	3

Electrical Specifications – DC and AC

Stresses greater than those listed in Table 9 may cause permanent damage to the device. This is a stress rating only, and functional operation of the device at these or any other conditions above those indicated in the operational sections of this specification is not implied. Exposure to absolute maximum rating conditions for extended periods may affect reliability.

Table 9: Absolute Maximum Ratings

Parameter	Min	Max	Units
VDD supply voltage relative to Vss	-1V	+3.6V	V
VDDQ supply voltage relative to Vss	-1V	+3.6V	V
VREF and inputs voltage relative to Vss	-1V	+3.6V	V
I/O pins voltage relative to Vss	-0.5V	VDDQ + 0.5V	V
Storage temperature (plastic)	-55	+150	°C
Short circuit output current	-	50	mA

Table 10: DC Electrical Characteristics and Operating Conditions (-5B)

Notes: 1–5 and 17 apply to the entire table; Notes appear on page 35; VDDQ = +2.6V ±0.1V, VDD = +2.6V ±0.1V

Parameter/Condition	Symbol	Min	Max	Units	Notes	
Supply voltage	VDD	+2.5	+2.7	V	37, 42	
I/O supply voltage	VDDQ	+2.5	+2.7	V	37, 42, 45	
I/O reference voltage	VREF	0.49 × VDDQ	0.51 × VDDQ	V	7, 45	
I/O termination voltage (system)	VTT	VREF - 0.04	VREF + 0.04	V	8, 45	
Input high (logic 1) voltage	VIH(DC)	VREF + 0.15	VDD + 0.3	V	29	
Input low (logic 0) voltage	VIL(DC)	-0.3	VREF - 0.15	V	29	
Input leakage current: Any input 0V ≤ VIN ≤ VDD, VREF pin 0V ≤ VIN ≤ 1.35V (All other pins not under test = 0V)	II	-2	+2	µA		
Output leakage current: (DQ are disabled; 0V ≤ VOUT ≤ VDDQ)	IOZ	-5	+5	µA		
Full-drive option output levels (x4, x8, x16):	High current (VOUT = VDDQ - 0.373V, minimum VREF, minimum VTT)	IOH	-16.8	-	mA	38, 40
	Low current (VOUT = 0.373V, maximum VREF, maximum VTT)	IOL	+16.8	-	mA	
Reduced-drive option output levels:	High current (VOUT = VDDQ - 0.373V, minimum VREF, minimum VTT)	IOHR	-9	-	mA	39, 40
	Low current (VOUT = 0.763V, maximum VREF, maximum VTT)	IOLR	+9	-	mA	
Ambient operating temperatures	Commercial	TA	0	+70	°C	
	Industrial	TA	-40	+85	°C	
	Automotive	TA	-40	+105	°C	

Table 11: DC Electrical Characteristics and Operating Conditions (-6, -6T, -75E, -75Z, -75)

 Notes: 1–5, 17 apply to the entire table; Notes appear on page 35; $V_{DDQ} = +2.5V \pm 0.2V$, $V_{DD} = +2.5V \pm 0.2V$

Parameter/Condition	Symbol	Min	Max	Units	Notes	
Supply voltage	VDD	+2.3	+2.7	V	37, 42	
I/O supply voltage	VDDQ	+2.3	+2.7	V	37, 42, 45	
I/O reference voltage	VREF	$0.49 \times V_{DDQ}$	$0.51 \times V_{DDQ}$	V	7, 45	
I/O termination voltage (system)	VTT	$V_{REF} - 0.04$	$V_{REF} + 0.04$	V	8, 45	
Input high (logic 1) voltage	V _{IH} (DC)	$V_{REF} + 0.15$	$V_{DD} + 0.3$	V	29	
Input low (logic 0) voltage	V _{IL} (DC)	-0.3	$V_{REF} - 0.15$	V	29	
Input leakage current: Any input $0V \leq V_{IN} \leq V_{DD}$, VREF pin $0V \leq V_{IN} \leq 1.35V$ (All other pins not under test = 0V)	I _I	-2	+2	μA		
Output leakage current: (DQ are disabled; $0V \leq V_{OUT} \leq V_{DDQ}$)	I _{OZ}	-5	+5	μA		
Full-drive option output levels (x4, x8, x16):	High current ($V_{OUT} = V_{DDQ} - 0.373V$, minimum VREF, minimum VTT)	I _{OH}	-16.8	-	mA	38, 40
	Low current ($V_{OUT} = 0.373V$, maximum VREF, maximum VTT)	I _{OL}	+16.8	-	mA	
Reduced-drive option output levels:	High current ($V_{OUT} = V_{DDQ} - 0.763V$, minimum VREF, minimum VTT)	I _{OHR}	-9	-	mA	39, 40
	Low current ($V_{OUT} = 0.763V$, maximum VREF, maximum VTT)	I _{OLR}	+9	-	mA	
Ambient operating temperatures	Commercial	T _A	0	+70	°C	
	Industrial	T _A	-40	+85	°C	
	Automotive	T _A	-40	+105	°C	

Table 12: AC Input Operating Conditions

Notes: 1–5, 17 apply to the entire table; Notes appear on page 35;

 $0^{\circ}C \leq T_A \leq +70^{\circ}C$; $V_{DDQ} = +2.5V \pm 0.2V$, $V_{DD} = +2.5V \pm 0.2V$ ($V_{DDQ} = +2.6V \pm 0.1V$, $V_{DD} = +2.6V \pm 0.1V$ for -5B)

Parameter/Condition	Symbol	Min	Max	Units	Notes
Input high (logic 1) voltage	V _{IH} (AC)	$V_{REF} + 0.310$	-	V	15, 29, 41
Input low (logic 0) voltage	V _{IL} (AC)	-	$V_{REF} - 0.310$	V	15, 29, 41
I/O reference voltage	VREF(AC)	$0.49 \times V_{DDQ}$	$0.51 \times V_{DDQ}$	V	7

Figure 10: Input Voltage Waveform

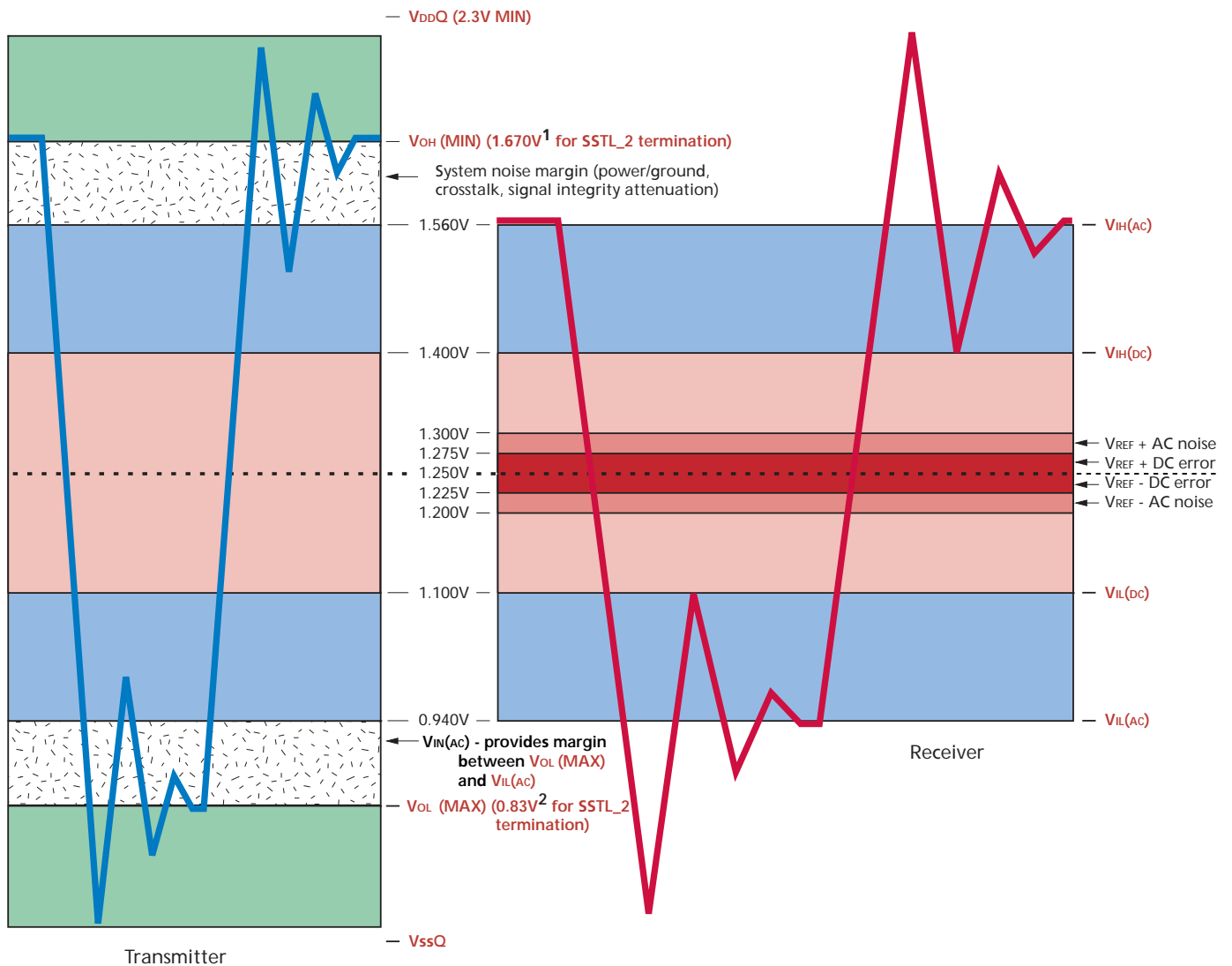

- Notes:
1. $V_{OH}(\text{MIN})$ with test load is 1.927V.
 2. $V_{OL}(\text{MAX})$ with test load is 0.373V.
 3. Numbers in diagram reflect nominal values utilizing circuit below for all devices other than -5B.

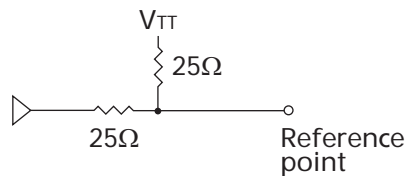

Table 13: Clock Input Operating Conditions

Notes: 1-5, 16, 17, 31 apply to the entire table; Notes appear on page 35;

$0^{\circ}\text{C} \leq T_A \leq +70^{\circ}\text{C}$; $V_{DDQ} = +2.5\text{V} \pm 0.2\text{V}$, $V_{DD} = +2.5\text{V} \pm 0.2\text{V}$ ($V_{DDQ} = +2.6\text{V} \pm 0.1\text{V}$, $V_{DD} = +2.6\text{V} \pm 0.1\text{V}$ for -5B)

Parameter/Condition	Symbol	Min	Max	Units	Notes
Clock input mid-point voltage: CK and CK#	VMP(DC)	1.15	1.35	V	7, 10
Clock input voltage level: CK and CK#	VIN(DC)	-0.3	$V_{DDQ} + 0.3$	V	7
Clock input differential voltage: CK and CK#	VID(DC)	0.36	$V_{DDQ} + 0.6$	V	7, 9
Clock input differential voltage: CK and CK#	VID(AC)	0.7	$V_{DDQ} + 0.6$	V	9
Clock input crossing point voltage: CK and CK#	VIX(AC)	$0.5 \times V_{DDQ} - 0.2$	$0.5 \times V_{DDQ} + 0.2$	V	10

Figure 11: SSTL_2 Clock Input

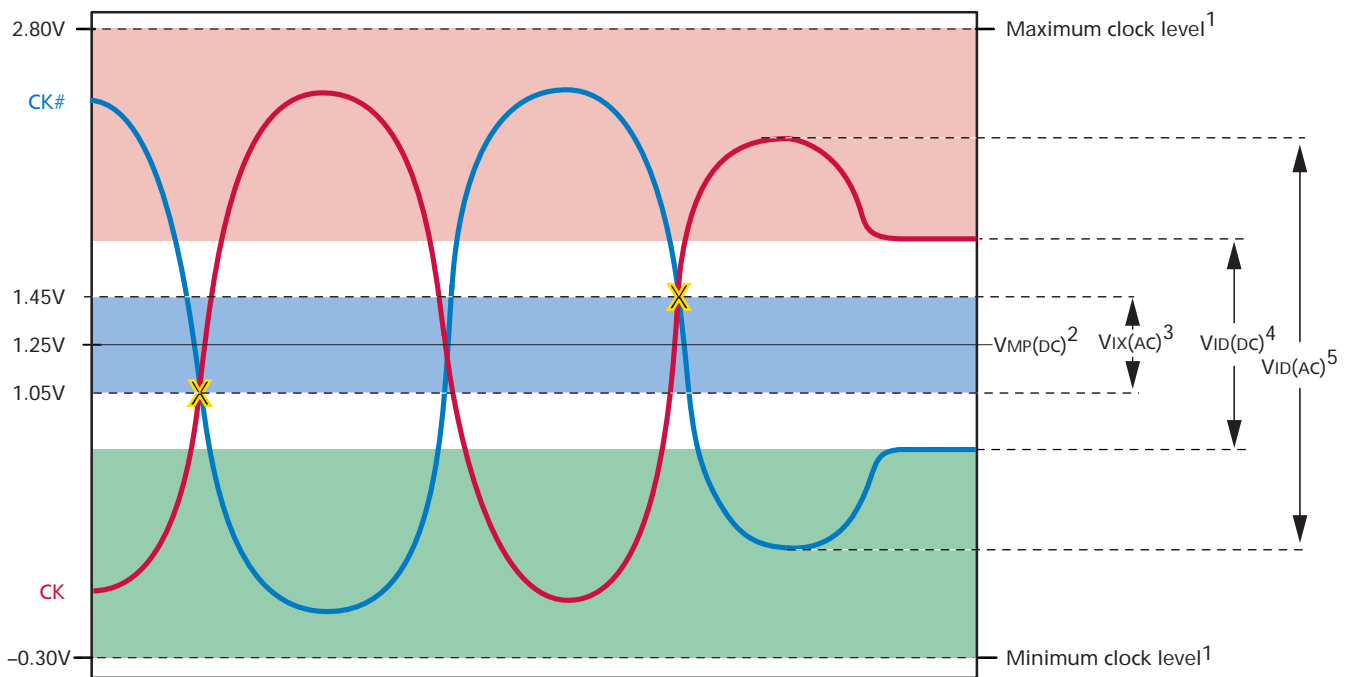

- Notes:
1. CK or CK# may not be more positive than $V_{DDQ} + 0.3\text{V}$ or more negative than $V_{SS} - 0.3\text{V}$.
 2. This provides a minimum of 1.15V to a maximum of 1.35V and is always half of V_{DDQ} .
 3. CK and CK# must cross in this region.
 4. CK and CK# must meet at least VID(DC) MIN when static and is centered around VMP(DC).
 5. CK and CK# must have a minimum 700mV peak-to-peak swing.
 6. For AC operation, all DC clock requirements must also be satisfied.
 7. Numbers in diagram reflect nominal values for all devices other than -5B.

Table 14: Capacitance (x4, x8 TSOP)

Note: 14 applies to the entire table; Notes appear on page 35

Parameter	Symbol	Min	Max	Units	Notes
Delta input/output capacitance: DQ0–DQ3 (x4), DQ0–DQ7 (x8)	DC _{IO}	–	0.50	pF	25
Delta input capacitance: Command and address	DC _{I1}	–	0.50	pF	30
Delta input capacitance: CK, CK#	DC _{I2}	–	0.25	pF	30
Input/output capacitance: DQ, DQS, DM	C _{IO}	4.0	5.0	pF	
Input capacitance: Command and address	C _{I1}	2.0	3.0	pF	
Input capacitance: CK, CK#	C _{I2}	2.0	3.0	pF	
Input capacitance: CKE	C _{I3}	2.0	3.0	pF	

Table 15: Capacitance (x4, x8 FBGA)

Note: 14 applies to the entire table; Notes appear on page 35

Parameter	Symbol	Min	Max	Units	Notes
Delta input/output capacitance: DQ, DQS, DM	DC _{IO}	–	0.50	pF	25
Delta input capacitance: Command and address	DC _{I1}	–	0.50	pF	30
Delta input capacitance: CK, CK#	DC _{I2}	–	0.25	pF	30
Input/output capacitance: DQ, DQS, DM	C _{IO}	3.5	4.5	pF	
Input capacitance: Command and address	C _{I1}	1.5	2.5	pF	
Input capacitance: CK, CK#	C _{I2}	1.5	2.5	pF	
Input capacitance: CKE	C _{I3}	1.5	2.5	pF	

Table 16: Capacitance (x16 TSOP)

Note: 14 applies to the entire table; Notes appear on page 35

Parameter	Symbol	Min	Max	Units	Notes
Delta input/output capacitance: DQ0–DQ7, LDQS, LDM	DC _{IO_L}	–	0.50	pF	25
Delta input/output capacitance: DQ8–DQ15, UDQS, UDM	DC _{IO_U}	–	0.50	pF	25
Delta input capacitance: Command and address	DC _{I1}	–	0.50	pF	30
Delta input capacitance: CK, CK#	DC _{I2}	–	0.25	pF	30
Input/output capacitance: DQ, LDQS, UDQS, LDM, UDM	C _{IO}	4.0	5.0	pF	
Input capacitance: Command and address	C _{I1}	2.0	3.0	pF	
Input capacitance: CK, CK#	C _{I2}	2.0	3.0	pF	
Input capacitance: CKE	C _{I3}	2.0	3.0	pF	

Table 17: Capacitance (x16 FBGA)

Note: 14 applies to the entire table; Notes appear on page 35

Parameter	Symbol	Min	Max	Units	Notes
Delta input/output capacitance: DQ0–DQ7, LDQS, LDM	DC _{IO_L}	–	0.50	pF	25
Delta input/output capacitance: DQ8–DQ15, UDQS, UDM	DC _{IO_U}	–	0.50	pF	25
Delta input capacitance: Command and address	DC _{I1}	–	0.50	pF	30
Delta input capacitance: CK, CK#	DC _{I2}	–	0.25	pF	30
Input/output capacitance: DQ, LDQS, UDQS, LDM, UDM	C _{IO}	3.5	4.5	pF	
Input capacitance: Command and address	C _{I1}	1.5	2.5	pF	
Input capacitance: CK, CK#	C _{I2}	1.5	2.5	pF	
Input capacitance: CKE	C _{I3}	1.5	2.5	pF	

Table 18: Electrical Characteristics and Recommended AC Operating Conditions (-5B)

Notes 1–6, 16–18, 34 apply to the entire table; Notes appear on page 35;
 $0^{\circ}\text{C} \leq T_A \leq +70^{\circ}\text{C}$; $V_{DDQ} = +2.6\text{V} \pm 0.1\text{V}$, $V_{DD} = +2.6\text{V} \pm 0.1\text{V}$

AC Characteristics		-5B		Units	Notes	
Parameter	Symbol	Min	Max			
Access window of DQ from CK/CK#	t_{AC}	-0.70	+0.70	ns		
CK high-level width	t_{CH}	0.45	0.55	t_{CK}	31	
Clock cycle time	CL = 3	$t_{CK} (3)$	5	7.5	ns	52
	CL = 2.5	$t_{CK} (2.5)$	6	13	ns	46, 52
	CL = 2	$t_{CK} (2)$	7.5	13	ns	46, 52
CK low-level width	t_{CL}	0.45	0.55	t_{CK}	31	
DQ and DM input hold time relative to DQS	t_{DH}	0.40	-	ns	27, 32	
DQ and DM input pulse width (for each input)	t_{DIPW}	1.75	-	ns	32	
Access window of DQS from CK/CK#	t_{DQSK}	-0.60	+0.60	ns		
DQS input high pulse width	t_{DQSH}	0.35	-	t_{CK}		
DQS input low pulse width	t_{DQSL}	0.35	-	t_{CK}		
DQS–DQ skew, DQS to last DQ valid, per group, per access	t_{DQSQ}	-	0.40	ns	26, 27	
WRITE command to first DQS latching transition	t_{DOSS}	0.72	1.28	t_{CK}		
DQ and DM input setup time relative to DQS	t_{DS}	0.40	-	ns	27, 32	
DQS falling edge from CK rising – hold time	t_{DSH}	0.2	-	t_{CK}		
DQS falling edge to CK rising – setup time	t_{DSS}	0.2	-	t_{CK}		
Half-clock period	t_{HP}	t_{CH}, t_{CL}	-	ns	35	
Data-out High-Z window from CK/CK#	t_{HZ}	-	+0.70	ns	19, 43	
Address and control input hold time (slew rate ≥ 0.5 V/ns)	t_{IH_F}	0.60	-	ns	15	
Address and control input pulse width (for each input)	t_{IPW}	2.2	-	ns		
Address and control input setup time (slew rate ≥ 0.5 V/ns)	t_{IS_F}	0.60	-	ns	15	
Data-out Low-Z window from CK/CK#	t_{LZ}	-0.70	-	ns	19, 43	
LOAD MODE REGISTER command cycle time	t_{MRD}	10	-	ns		
DQ–DQS hold, DQS to first DQ to go non-valid, per access	t_{QH}	$t_{HP} - t_{QHS}$	-	ns	26, 27	
Data hold skew factor	t_{QHS}	-	0.50	ns		
ACTIVE-to-READ with auto precharge command	t_{RAP}	15	-	ns		
ACTIVE-to-PRECHARGE command	t_{RAS}	40	70,000	ns	36	
ACTIVE-to-ACTIVE/AUTO REFRESH command period	t_{RC}	55	-	ns		
ACTIVE-to-READ or WRITE delay	t_{RCD}	15	-	ns		
REFRESH-to-REFRESH command interval	t_{REFC}	-	70.3	μs	24	
REFRESH-to-REFRESH command interval (Automotive)	$t_{REFC_{AT}}$	-	17.55	μs	24	
Average periodic refresh interval	t_{REFI}	-	7.8	μs	24	
Average periodic refresh interval (Automotive)	$t_{REFI_{AT}}$	-	1.95	μs	24	
AUTO REFRESH command period	t_{RFC}	70	-	ns	50	
PRECHARGE command period	t_{RP}	15	-	ns		
DQS read preamble	t_{RPRE}	0.9	1.1	t_{CK}	44	
DQS read postamble	t_{RPST}	0.4	0.6	t_{CK}	44	
ACTIVE bank a to ACTIVE bank b command	t_{RRD}	10	-	ns		
Terminating voltage delay to VDD	t_{VTD}	0	-	ns		
DQS write preamble	t_{WPRE}	0.25	-	t_{CK}		
DQS write preamble setup time	t_{WPRES}	0	-	ns	21, 22	
DQS write postamble	t_{WPST}	0.4	0.6	t_{CK}	20	

Table 18: Electrical Characteristics and Recommended AC Operating Conditions (-5B) (continued)

Notes 1–6, 16–18, 34 apply to the entire table; Notes appear on page 35;

$0^{\circ}\text{C} \leq T_A \leq +70^{\circ}\text{C}$; $V_{DDQ} = +2.6\text{V} \pm 0.1\text{V}$, $V_{DD} = +2.6\text{V} \pm 0.1\text{V}$

AC Characteristics		-5B		Units	Notes
Parameter	Symbol	Min	Max		
Write recovery time	t_{WR}	15	–	ns	
Internal WRITE-to-READ command delay	t_{WTR}	2	–	t_{CK}	
Exit SELF REFRESH-to-non-READ command	t_{XSNR}	70	–	ns	
Exit SELF REFRESH-to-READ command	t_{XSRD}	200	–	t_{CK}	
Data valid output window	n/a	$t_{QH} - t_{DQSQ}$		ns	26

Table 19: Electrical Characteristics and Recommended AC Operating Conditions (-6)

Notes: 1–6, 16–18, 34 apply to the entire table; Notes appear on page 35;

 $0^{\circ}\text{C} \leq T_A \leq +70^{\circ}\text{C}$; $V_{DDQ} = +2.5\text{V} \pm 0.2\text{V}$, $V_{DD} = +2.5\text{V} \pm 0.2\text{V}$

AC Characteristics		-6 (FBGA)		Units	Notes	
Parameter	Symbol	Min	Max			
Access window of DQ from CK/CK#	t_{AC}	-0.70	+0.70	ns		
CK high-level width	t_{CH}	0.45	0.55	t_{CK}	31	
Clock cycle time	CL = 2.5	$t_{CK} (2.5)$	6	13	ns	46, 52
	CL = 2	$t_{CK} (2)$	7.5	13	ns	46, 52
CK low-level width	t_{CL}	0.45	0.55	t_{CK}	31	
DQ and DM input hold time relative to DQS	t_{DH}	0.45	-	ns	27, 32	
DQ and DM input pulse width (for each input)	t_{DIPW}	1.75	-	ns	32	
Access window of DQS from CK/CK#	t_{DQSK}	-0.6	+0.6	ns		
DQS input high pulse width	t_{DQSH}	0.35	-	t_{CK}		
DQS input low pulse width	t_{DQSL}	0.35	-	t_{CK}		
DQS–DQ skew, DQS to last DQ valid, per group, per access	t_{DQSQ}	-	0.4	ns	26, 27	
WRITE command to first DQS latching transition	t_{DQSS}	0.75	1.25	t_{CK}		
DQ and DM input setup time relative to DQS	t_{DS}	0.45	-	ns	27, 32	
DQS falling edge from CK rising - hold time	t_{DSH}	0.2	-	t_{CK}		
DQS falling edge to CK rising - setup time	t_{DSS}	0.2	-	t_{CK}		
Half-clock period	t_{HP}	t_{CH} , t_{CL}	-	ns	35	
Data-out High-Z window from CK/CK#	t_{HZ}	-	+0.7	ns	19, 43	
Address and control input hold time (fast slew rate)	t_{IH_F}	0.75	-	ns		
Address and control input hold time (slow slew rate)	t_{IH_S}	0.8	-	ns	15	
Address and control input pulse width (for each input)	t_{IPW}	2.2	-	ns		
Address and control input setup time (fast slew rate)	t_{IS_F}	0.75	-	ns		
Address and control input setup time (slow slew rate)	t_{IS_S}	0.8	-	ns	15	
Data-out Low-Z window from CK/CK#	t_{LZ}	-0.7	-	ns	19, 43	
LOAD MODE REGISTER command cycle time	t_{MRD}	12	-	ns		
DQ–DQS hold, DQS to first DQ to go non-valid, per access	t_{QH}	$t_{HP} - t_{QHS}$	-	ns	26, 27	
Data hold skew factor	t_{QHS}	-	0.50	ns		
ACTIVE-to-READ with auto precharge command	t_{RAP}	15	-	ns		
ACTIVE-to-PRECHARGE command	t_{RAS}	42	70,000	ns	36, 54	
ACTIVE-to-ACTIVE/AUTO REFRESH command period	t_{RC}	60	-	ns		
ACTIVE-to-READ or WRITE delay	t_{RCD}	15	-	ns		
REFRESH-to-REFRESH command interval	t_{REFC}	-	70.3	μs	24	
REFRESH-to-REFRESH command interval (Automotive)	$t_{REFC_{AT}}$	-	17.55	μs	24	
Average periodic refresh interval	t_{REFI}	-	7.8	μs	24	
Average periodic refresh interval (Automotive)	$t_{REFI_{AT}}$	-	1.95	μs	24	
AUTO REFRESH command period	t_{RFC}	72	-	ns	50	
PRECHARGE command period	t_{RP}	15	-	ns		
DQS read preamble	t_{RPRE}	0.9	1.1	t_{CK}	44	
DQS read postamble	t_{RPST}	0.4	0.6	t_{CK}	44	
ACTIVE bank <i>a</i> to ACTIVE bank <i>b</i> command	t_{RRD}	12	-	ns		
Terminating voltage delay to V_{SS}	t_{VTD}	0	-	ns		
DQS write preamble	t_{WPRE}	0.25	-	t_{CK}		

Table 19: Electrical Characteristics and Recommended AC Operating Conditions (-6) (continued)

Notes: 1–6, 16–18, 34 apply to the entire table; Notes appear on page 35;

$0^{\circ}\text{C} \leq T_A \leq +70^{\circ}\text{C}$; $V_{DDQ} = +2.5\text{V} \pm 0.2\text{V}$, $V_{DD} = +2.5\text{V} \pm 0.2\text{V}$

AC Characteristics		-6 (FBGA)		Units	Notes
Parameter	Symbol	Min	Max		
DQS write preamble setup time	t_{WPRES}	0	–	ns	21, 22
DQS write postamble	t_{WPST}	0.4	0.6	t_{CK}	20
Write recovery time	t_{WR}	15	–	ns	
Internal WRITE-to-READ command delay	t_{WTR}	1	–	t_{CK}	
Exit SELF REFRESH-to-non-READ command	t_{XSNR}	75	–	ns	
Exit SELF REFRESH-to-READ command	t_{XSRD}	200	–	t_{CK}	
Data valid output window	n/a	$t_{OH} - t_{DQSQ}$		ns	26

Table 20: Electrical Characteristics and Recommended AC Operating Conditions (-6T)

Notes: 1–6, 16–18, 34 apply to the entire table; Notes appear on page 35;

 $0^{\circ}\text{C} \leq T_A \leq +70^{\circ}\text{C}$; $V_{DDQ} = +2.5\text{V} \pm 0.2\text{V}$, $V_{DD} = +2.5\text{V} \pm 0.2\text{V}$

AC Characteristics		-6T (TSOP)		Units	Notes	
Parameter	Symbol	Min	Max			
Access window of DQ from CK/CK#	t_{AC}	-0.70	+0.70	ns		
CK high-level width	t_{CH}	0.45	0.55	t_{CK}	31	
Clock cycle time	CL = 2.5	$t_{CK} (2.5)$	6	13	ns	46, 52
	CL = 2	$t_{CK} (2)$	7.5	13	ns	46, 52
CK low-level width	t_{CL}	0.45	0.55	t_{CK}	31	
DQ and DM input hold time relative to DQS	t_{DH}	0.45	-	ns	27, 32	
DQ and DM input pulse width (for each input)	t_{DIPW}	1.75	-	ns	32	
Access window of DQS from CK/CK#	t_{DQSCK}	-0.6	+0.6	ns		
DQS input high pulse width	t_{DQSH}	0.35	-	t_{CK}		
DQS input low pulse width	t_{DQSL}	0.35	-	t_{CK}		
DQS–DQ skew, DQS to last DQ valid, per group, per access	t_{DQSQ}	-	0.45	ns	26, 27	
WRITE command to first DQS latching transition	t_{DQSS}	0.75	1.25	t_{CK}		
DQ and DM input setup time relative to DQS	t_{DS}	0.45	-	ns	27, 32	
DQS falling edge from CK rising - hold time	t_{DSH}	0.2	-	t_{CK}		
DQS falling edge to CK rising - setup time	t_{DSS}	0.2	-	t_{CK}		
Half-clock period	t_{HP}	t_{CH} , t_{CL}	-	ns	35	
Data-out High-Z window from CK/CK#	t_{HZ}	-	+0.7	ns	19, 43	
Address and control input hold time (fast slew rate)	t_{IH_F}	0.75	-	ns		
Address and control input hold time (slow slew rate)	t_{IH_S}	0.8	-	ns	15	
Address and control input pulse width (for each input)	t_{IPW}	2.2	-	ns		
Address and control input setup time (fast slew rate)	t_{IS_F}	0.75	-	ns		
Address and control input setup time (slow slew rate)	t_{IS_S}	0.8	-	ns	15	
Data-out Low-Z window from CK/CK#	t_{LZ}	-0.7	-	ns	19, 43	
LOAD MODE REGISTER command cycle time	t_{MRD}	12	-	ns		
DQ–DQS hold, DQS to first DQ to go non-valid, per access	t_{QH}	$t_{HP} - t_{QHS}$	-	ns	26, 27	
Data hold skew factor	t_{QHS}	-	0.55	ns		
ACTIVE-to-READ with auto precharge command	t_{RAP}	15	-	ns		
ACTIVE-to-PRECHARGE command	t_{RAS}	42	70,000	ns	36, 54	
ACTIVE-to-ACTIVE/AUTO REFRESH command period	t_{RC}	60	-	ns		
ACTIVE-to-READ or WRITE delay	t_{RCD}	15	-	ns		
REFRESH-to-REFRESH command interval	t_{REFC}	-	70.3	μs	24	
REFRESH-to-REFRESH command interval (Automotive)	$t_{REFC_{AT}}$	-	17.55	μs	24	
Average periodic refresh interval	t_{REFI}	-	7.8	μs	24	
Average periodic refresh interval (Automotive)	$t_{REFI_{AT}}$	-	1.95	μs	24	
AUTO REFRESH command period	t_{RFC}	72	-	ns	50	
PRECHARGE command period	t_{RP}	15	-	ns		
DQS read preamble	t_{RPRE}	0.9	1.1	t_{CK}	44	
DQS read postamble	t_{RPST}	0.4	0.6	t_{CK}	44	
ACTIVE bank <i>a</i> to ACTIVE bank <i>b</i> command	t_{RRD}	12	-	ns		
Terminating voltage delay to V_{SS}	t_{VTD}	0	-	ns		
DQS write preamble	t_{WPRE}	0.25	-	t_{CK}		

Table 20: Electrical Characteristics and Recommended AC Operating Conditions (-6T) (continued)

Notes: 1–6, 16–18, 34 apply to the entire table; Notes appear on page 35;

$0^{\circ}\text{C} \leq T_A \leq +70^{\circ}\text{C}$; $V_{DDQ} = +2.5\text{V} \pm 0.2\text{V}$, $V_{DD} = +2.5\text{V} \pm 0.2\text{V}$

AC Characteristics		-6T (TSOP)		Units	Notes
Parameter	Symbol	Min	Max		
DQS write preamble setup time	t_{WPRES}	0	–	ns	21, 22
DQS write postamble	t_{WPST}	0.4	0.6	t_{CK}	20
Write recovery time	t_{WR}	15	–	ns	
Internal WRITE-to-READ command delay	t_{WTR}	1	–	t_{CK}	
Exit SELF REFRESH-to-non-READ command	t_{XSNR}	75	–	ns	
Exit SELF REFRESH-to-READ command	t_{XSRD}	200	–	t_{CK}	
Data valid output window	n/a	$t_{OH} - t_{DQSQ}$		ns	26

Table 21: Electrical Characteristics and Recommended AC Operating Conditions (-75E)

Notes: 1–6, 16–18, 34 apply to the entire table; Notes appear on page 35;

 $0^{\circ}\text{C} \leq T_A \leq +70^{\circ}\text{C}$; $V_{DDQ} = +2.5\text{V} \pm 0.2\text{V}$, $V_{DD} = +2.5\text{V} \pm 0.2\text{V}$

AC Characteristics		-75E		Units	Notes	
Parameter	Symbol	Min	Max			
Access window of DQ from CK/CK#	t_{AC}	-0.75	+0.75	ns		
CK high-level width	t_{CH}	0.45	0.55	t_{CK}	31	
Clock cycle time	CL = 2.5	$t_{CK} (2.5)$	7.5	13	ns	46, 52
	CL = 2	$t_{CK} (2)$	7.5	13	ns	46, 52
CK low-level width	t_{CL}	0.45	0.55	t_{CK}	31	
DQ and DM input hold time relative to DQS	t_{DH}	0.5	-	ns	27, 32	
DQ and DM input pulse width (for each input)	t_{DIPW}	1.75	-	ns	32	
Access window of DQS from CK/CK#	t_{DQSCK}	-0.75	+0.75	ns		
DQS input high pulse width	t_{DQSH}	0.35	-	t_{CK}		
DQS input low pulse width	t_{DQSL}	0.35	-	t_{CK}		
DQS–DQ skew, DQS to last DQ valid, per group, per access	t_{DQSQ}	-	0.5	ns	26, 27	
WRITE command to first DQS latching transition	t_{DQSS}	0.75	1.25	t_{CK}		
DQ and DM input setup time relative to DQS	t_{DS}	0.5	-	ns	27, 32	
DQS falling edge from CK rising - hold time	t_{DSH}	0.2	-	t_{CK}		
DQS falling edge to CK rising - setup time	t_{DSS}	0.2	-	t_{CK}		
Half-clock period	t_{HP}	t_{CH} , t_{CL}	-	ns	35	
Data-out High-Z window from CK/CK#	t_{HZ}	-	+0.75	ns	19, 43	
Address and control input hold time (fast slew rate)	t_{IH_F}	0.90	-	ns		
Address and control input hold time (slow slew rate)	t_{IH_S}	1	-	ns	15	
Address and control input pulse width (for each input)	t_{IPW}	2.2	-	ns		
Address and control input setup time (fast slew rate)	t_{IS_F}	0.90	-	ns		
Address and control input setup time (slow slew rate)	t_{IS_S}	1	-	ns	15	
Data-out Low-Z window from CK/CK#	t_{LZ}	-0.75	-	ns	19, 43	
LOAD MODE REGISTER command cycle time	t_{MRD}	15	-	ns		
DQ–DQS hold, DQS to first DQ to go non-valid, per access	t_{QH}	$t_{HP} - t_{QHS}$	-	ns	26, 27	
Data hold skew factor	t_{QHS}	-	0.75	ns		
ACTIVE-to-READ with auto precharge command	t_{RAP}	15	-	ns		
ACTIVE-to-PRECHARGE command	t_{RAS}	40	120,000	ns	36, 54	
ACTIVE-to-ACTIVE/AUTO REFRESH command period	t_{RC}	60	-	ns		
ACTIVE-to-READ or WRITE delay	t_{RCD}	15	-	ns		
REFRESH-to-REFRESH command interval	t_{REFC}	-	70.3	μs	24	
REFRESH-to-REFRESH command interval (Automotive)	$t_{REFC_{AT}}$	-	17.55	μs	24	
Average periodic refresh interval	t_{REFI}	-	7.8	μs	24	
Average periodic refresh interval (Automotive)	$t_{REFI_{AT}}$	-	1.95	μs	24	
AUTO REFRESH command period	t_{RFC}	75	-	ns	50	
PRECHARGE command period	t_{RP}	15	-	ns		
DQS read preamble	t_{RPRE}	0.9	1.1	t_{CK}	44	
DQS read postamble	t_{RPST}	0.4	0.6	t_{CK}	44	
ACTIVE bank a to ACTIVE bank b command	t_{RRD}	15	-	ns		
Terminating voltage delay to Vss	t_{VTD}	0	-	ns		
DQS write preamble	t_{WPRE}	0.25	-	t_{CK}		

Table 21: Electrical Characteristics and Recommended AC Operating Conditions (-75E) (continued)

Notes: 1–6, 16–18, 34 apply to the entire table; Notes appear on page 35;

$0^{\circ}\text{C} \leq T_A \leq +70^{\circ}\text{C}$; $V_{DDQ} = +2.5\text{V} \pm 0.2\text{V}$, $V_{DD} = +2.5\text{V} \pm 0.2\text{V}$

AC Characteristics		-75E		Units	Notes
Parameter	Symbol	Min	Max		
DQS write preamble setup time	t_{WPRES}	0	–	ns	21, 22
DQS write postamble	t_{WPST}	0.4	0.6	t_{CK}	20
Write recovery time	t_{WR}	15	–	ns	
Internal WRITE-to-READ command delay	t_{WTR}	1	–	t_{CK}	
Exit SELF REFRESH-to-non-READ command	t_{XSNR}	75	–	ns	
Exit SELF REFRESH-to-READ command	t_{XSRD}	200	–	t_{CK}	
Data valid output window	n/a	$t_{OH} - t_{DQSQ}$		ns	26

Table 22: Electrical Characteristics and Recommended AC Operating Conditions (-75Z)

Notes: 1–6, 16–18, 34 apply to the entire table; Notes appear on page 35;

 $0^{\circ}\text{C} \leq T_A \leq +70^{\circ}\text{C}$; $V_{DDQ} = +2.5\text{V} \pm 0.2\text{V}$, $V_{DD} = +2.5\text{V} \pm 0.2\text{V}$

AC Characteristics		-75Z		Units	Notes	
Parameter	Symbol	Min	Max			
Access window of DQ from CK/CK#	t^{AC}	-0.75	+0.75	ns		
CK high-level width	t^{CH}	0.45	0.55	t^{CK}	31	
Clock cycle time	CL = 2.5	$t^{\text{CK}}(2.5)$	7.5	13	ns	46
	CL = 2	$t^{\text{CK}}(2)$	7.5	13	ns	46
CK low-level width	t^{CL}	0.45	0.55	t^{CK}	31	
DQ and DM input hold time relative to DQS	t^{DH}	0.5	-	ns	27, 32	
DQ and DM input pulse width (for each input)	t^{DIPW}	1.75	-	ns	32	
Access window of DQS from CK/CK#	t^{DQSK}	-0.75	+0.75	ns		
DQS input high pulse width	t^{DQSH}	0.35	-	t^{CK}		
DQS input low pulse width	t^{DQSL}	0.35	-	t^{CK}		
DQS–DQ skew, DQS to last DQ valid, per group, per access	t^{DQSQ}	-	0.5	ns	26, 27	
WRITE command-to-first DQS latching transition	t^{DQSS}	0.75	1.25	t^{CK}		
DQ and DM input setup time relative to DQS	t^{DS}	0.5	-	ns	27, 32	
DQS falling edge from CK rising – hold time	t^{DSH}	0.2	-	t^{CK}		
DQS falling edge to CK rising – setup time	t^{DSS}	0.2	-	t^{CK}		
Half-clock period	t^{HP}	$t^{\text{CH}}, t^{\text{CL}}$	-	ns	35	
Data-out High-Z window from CK/CK#	t^{HZ}	-	+0.75	ns	19, 43	
Address and control input hold time (fast slew rate)	t^{IH}_{F}	0.90	-	ns		
Address and control input hold time (slow slew rate)	t^{IH}_{S}	1	-	ns	15	
Address and control input pulse width (for each input)	t^{IPW}	2.2	-	ns		
Address and control input setup time (fast slew rate)	t^{IS}_{F}	0.90	-	ns		
Address and control input setup time (slow slew rate)	t^{IS}_{S}	1	-	ns	15	
Data-out Low-Z window from CK/CK#	t^{LZ}	-0.75	-	ns	19, 43	
LOAD MODE REGISTER command cycle time	t^{MRD}	15	-	ns		
DQ–DQS hold, DQS to first DQ to go non-valid, per access	t^{QH}	$t^{\text{HP}} - t^{\text{QHS}}$	-	ns	26, 27	
Data hold skew factor	t^{QHS}	-	0.75	ns		
ACTIVE-to-READ with auto precharge command	t^{RAP}	20	-	ns		
ACTIVE-to-PRECHARGE command	t^{RAS}	40	120,000	ns	36	
ACTIVE-to-ACTIVE/AUTO REFRESH command period	t^{RC}	65	-	ns		
ACTIVE-to-READ or WRITE delay	t^{RCD}	20	-	ns		
REFRESH-to-REFRESH command interval	t^{REFC}	-	70.3	μs	24	
REFRESH-to-REFRESH command interval (Automotive)	$t^{\text{REFC}}_{\text{AT}}$	-	17.55	μs	24	
Average periodic refresh interval	t^{REFI}	-	7.8	μs	24	
Average periodic refresh interval (Automotive)	$t^{\text{REFI}}_{\text{AT}}$	-	1.95	μs	24	
AUTO REFRESH command period	t^{RFC}	75	-	ns	50	
PRECHARGE command period	t^{RP}	20	-	ns		
DQS read preamble	t^{RPRE}	0.9	1.1	t^{CK}	44	
DQS read postamble	t^{RPST}	0.4	0.6	t^{CK}	44	
ACTIVE bank a to ACTIVE bank b command	t^{RRD}	15	-	ns		
Terminating voltage delay to VDD	t^{VTD}	0	-	ns		
DQS write preamble	t^{WPRE}	0.25	-	t^{CK}		
DQS write preamble setup time	t^{WPRES}	0	-	ns	21, 22	

Table 22: Electrical Characteristics and Recommended AC Operating Conditions (-75Z) (continued)

Notes: 1–6, 16–18, 34 apply to the entire table; Notes appear on page 35;

$0^{\circ}\text{C} \leq T_A \leq +70^{\circ}\text{C}$; $V_{DDQ} = +2.5\text{V} \pm 0.2\text{V}$, $V_{DD} = +2.5\text{V} \pm 0.2\text{V}$

AC Characteristics		-75Z		Units	Notes
Parameter	Symbol	Min	Max		
DQS write postamble	t_{WPST}	0.4	0.6	t_{CK}	20
Write recovery time	t_{WR}	15	–	ns	
Internal WRITE-to-READ command delay	t_{WTR}	1	–	t_{CK}	
Exit SELF REFRESH-to-non-READ command	t_{XSNR}	75	–	ns	
Exit SELF REFRESH-to-READ command	t_{XSRD}	200	–	t_{CK}	
Data valid output window	n/a	$t_{QH} - t_{DQSQ}$		ns	26

Table 23: Electrical Characteristics and Recommended AC Operating Conditions (-75)

Notes: 1–6, 16–18, 34 apply to the entire table; Notes appear on page 35;

 $0^{\circ}\text{C} \leq T_A \leq +70^{\circ}\text{C}$; $V_{DDQ} = +2.5\text{V} \pm 0.2\text{V}$, $V_{DD} = +2.5\text{V} \pm 0.2\text{V}$

AC Characteristics		-75		Units	Notes	
Parameter	Symbol	Min	Max			
Access window of DQ from CK/CK#	t_{AC}	-0.75	+0.75	ns		
CK high-level width	t_{CH}	0.45	0.55	t_{CK}	31	
Clock cycle time	CL = 2.5	$t_{CK}(2.5)$	7.5	13	ns	46
	CL = 2	$t_{CK}(2)$	10	13	ns	46
CK low-level width	t_{CL}	0.45	0.55	t_{CK}	31	
DQ and DM input hold time relative to DQS	t_{DH}	0.5	-	ns	27, 32	
DQ and DM input pulse width (for each input)	t_{DIPW}	1.75	-	ns	32	
Access window of DQS from CK/CK#	t_{DQSK}	-0.75	+0.75	ns		
DQS input high pulse width	t_{DQSH}	0.35	-	t_{CK}		
DQS input low pulse width	t_{DQSL}	0.35	-	t_{CK}		
DQS–DQ skew, DQS to last DQ valid, per group, per access	t_{DQSQ}	-	0.5	ns	26, 27	
WRITE command-to-first DQS latching transition	t_{DQSS}	0.75	1.25	t_{CK}		
DQ and DM input setup time relative to DQS	t_{DS}	0.5	-	ns	27, 32	
DQS falling edge from CK rising – hold time	t_{DSH}	0.2	-	t_{CK}		
DQS falling edge to CK rising – setup time	t_{DSS}	0.2	-	t_{CK}		
Half-clock period	t_{HP}	t_{CH}, t_{CL}	-	ns	35	
Data-out High-Z window from CK/CK#	t_{HZ}	-	+0.75	ns	19, 43	
Address and control input hold time (fast slew rate)	t_{IH_F}	0.90	-	ns		
Address and control input hold time (slow slew rate)	t_{IH_S}	1	-	ns	15	
Address and control input pulse width (for each input)	t_{IPW}	2.2	-	ns		
Address and control input setup time (fast slew rate)	t_{IS_F}	0.90	-	ns		
Address and control input setup time (slow slew rate)	t_{IS_S}	1	-	ns	15	
Data-out Low-Z window from CK/CK#	t_{LZ}	-0.75	-	ns	19, 43	
LOAD MODE REGISTER command cycle time	t_{MRD}	15	-	ns		
DQ–DQS hold, DQS to first DQ to go non-valid, per access	t_{QH}	$t_{HP} - t_{QHS}$	-	ns	26, 27	
Data hold skew factor	t_{QHS}	-	0.75	ns		
ACTIVE-to-READ with auto precharge command	t_{RAP}	20	-	ns		
ACTIVE-to-PRECHARGE command	t_{RAS}	40	120,000	ns	36	
ACTIVE-to-ACTIVE/AUTO REFRESH command period	t_{RC}	65	-	ns		
ACTIVE-to-READ or WRITE delay	t_{RCD}	20	-	ns		
REFRESH-to-REFRESH command interval	t_{REFC}	-	70.3	μs	24	
REFRESH-to-REFRESH command interval (Automotive)	$t_{REFC_{AT}}$	-	17.55	μs	24	
Average periodic refresh interval	t_{REFI}	-	7.8	μs	24	
Average periodic refresh interval (Automotive)	$t_{REFI_{AT}}$	-	1.95	μs	24	
AUTO REFRESH command period	t_{RFC}	75	-	ns	50	
PRECHARGE command period	t_{RP}	20	-	ns		
DQS read preamble	t_{RPRE}	0.9	1.1	t_{CK}	44	
DQS read postamble	t_{RPST}	0.4	0.6	t_{CK}	44	
ACTIVE bank a to ACTIVE bank b command	t_{RRD}	15	-	ns		
Terminating voltage delay to VDD	t_{VTD}	0	-	ns		
DQS write preamble	t_{WPRE}	0.25	-	t_{CK}		
DQS write preamble setup time	t_{WPRES}	0	-	ns	21, 22	

Table 23: Electrical Characteristics and Recommended AC Operating Conditions (-75) (continued)

Notes: 1–6, 16–18, 34 apply to the entire table; Notes appear on page 35;
 $0^{\circ}\text{C} \leq T_A \leq +70^{\circ}\text{C}$; $V_{DDQ} = +2.5\text{V} \pm 0.2\text{V}$, $V_{DD} = +2.5\text{V} \pm 0.2\text{V}$

AC Characteristics		-75		Units	Notes
Parameter	Symbol	Min	Max		
DQS write postamble	tWPST	0.4	0.6	tCK	20
Write recovery time	tWR	15	–	ns	
Internal WRITE-to-READ command delay	t ^W TR	1	–	tCK	
Exit SELF REFRESH-to-non-READ command	t ^X SNR	75	–	ns	
Exit SELF REFRESH-to-READ command	t ^X SRD	200	–	tCK	
Data valid output window	n/a	t ^Q H - t ^D QSQ		ns	26

Table 24: Input Slew Rate Derating Values for Addresses and Commands

Note: 15 applies to the entire table; Notes appear on page 35;
 $0^{\circ}\text{C} \leq T_A \leq +70^{\circ}\text{C}$; $V_{DDQ} = +2.5\text{V} \pm 0.2\text{V}$, $V_{DD} = +2.5\text{V} \pm 0.2\text{V}$

Speed	Slew Rate	t ^I S	t ^I H	Units
-75Z/-75E	0.500 V/ns	1.00	1	ns
-75Z/-75E	0.400 V/ns	1.05	1	ns
-75Z/-75E	0.300 V/ns	1.10	1	ns

Table 25: Input Slew Rate Derating Values for DQ, DQS, and DM

Note: 32 applies to the entire table; Notes appear on page 35;
 $0^{\circ}\text{C} \leq T_A \leq +70^{\circ}\text{C}$; $V_{DDQ} = +2.5\text{V} \pm 0.2\text{V}$, $V_{DD} = +2.5\text{V} \pm 0.2\text{V}$

Speed	Slew Rate	t ^D S	t ^D H	Units
-75Z/-75E	0.500 V/ns	0.50	0.50	ns
-75Z/-75E	0.400 V/ns	0.55	0.55	ns
-75Z/-75E	0.300 V/ns	0.60	0.60	ns

Notes

1. All voltages referenced to VSS.
2. Tests for AC timing, I_{DD} , and electrical AC and DC characteristics may be conducted at nominal reference/supply voltage levels, but the related specifications and the device operation are guaranteed for the full voltage range specified.
3. Outputs (except for I_{DD} measurements) measured with equivalent load:

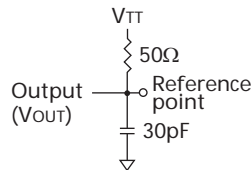

4. AC timing and I_{DD} tests may use a V_{IL} -to- V_{IH} swing of up to 1.5V in the test environment, but input timing is still referenced to V_{REF} (or to the crossing point for CK/CK#), and parameter specifications are guaranteed for the specified AC input levels under normal use conditions. The minimum slew rate for the input signals used to test the device is 1 V/ns in the range between $V_{IL(AC)}$ and $V_{IH(AC)}$.
5. The AC and DC input level specifications are as defined in the SSTL_2 standard (that is, the receiver will effectively switch as a result of the signal crossing the AC input level and will remain in that state as long as the signal does not ring back above [below] the DC input LOW [HIGH] level).
6. All speed grades are not offered on all densities. Refer to page 1 for availability.
7. V_{REF} is expected to equal $V_{DDQ}/2$ of the transmitting device and to track variations in the DC level of the same. Peak-to-peak noise (noncommon mode) on V_{REF} may not exceed $\pm 2\%$ of the DC value. Thus, from $V_{DDQ}/2$, V_{REF} is allowed $\pm 25\text{mV}$ for DC error and an additional $\pm 25\text{mV}$ for AC noise. This measurement is to be taken at the nearest V_{REF} bypass capacitor.
8. V_{TT} is not applied directly to the device. V_{TT} is a system supply for signal termination resistors, it is expected to be set equal to V_{REF} , and it must track variations in the DC level of V_{REF} .
9. V_{ID} is the magnitude of the difference between the input level on CK and the input level on CK#.
10. The value of V_{IX} and V_{MP} is expected to equal $V_{DDQ}/2$ of the transmitting device and must track variations in the DC level of the same.
11. I_{DD} is dependent on output loading and cycle rates. Specified values are obtained with minimum cycle times at $CL = 3$ for -5B; $CL = 2.5$, -6/-6T/-75; and $CL = 2$, -75E/-75Z speeds with the outputs open.
12. Enables on-chip refresh and address counters.
13. I_{DD} specifications are tested after the device is properly initialized and is averaged at the defined cycle rate.
14. This parameter is sampled. $V_{DD} = +2.5\text{V} \pm 0.2\text{V}$, $V_{DDQ} = +2.5\text{V} \pm 0.2\text{V}$, $V_{REF} = V_{SS}$, $f = 100\text{MHz}$, $T_A = 25^\circ\text{C}$, $V_{OUT(DC)} = V_{DDQ}/2$, V_{OUT} (peak-to-peak) = 0.2V. DM input is grouped with I/O pins, reflecting the fact that they are matched in loading.
15. For slew rates less than 1 V/ns and greater than or equal to 0.5 V/ns. If the slew rate is less than 0.5 V/ns, timing must be derated: t_{IS} has an additional 50ps per each 100 mV/ns reduction in slew rate from the 500 mV/ns. t_{IH} has 0ps added, that is, it remains constant. If the slew rate exceeds 4.5 V/ns, functionality is uncertain. For -5B, -6, and -6T, slew rates must be greater than or equal to 0.5 V/ns.

16. The CK/CK# input reference level (for timing referenced to CK/CK#) is the point at which CK and CK# cross; the input reference level for signals other than CK/CK# is V_{REF} .
17. Inputs are not recognized as valid until V_{REF} stabilizes. Once initialized, including self refresh mode, V_{REF} must be powered within specified range. Exception: during the period before V_{REF} stabilizes, $CKE < 0.3 \times V_{DD}$ is recognized as LOW.
18. The output timing reference level, as measured at the timing reference point (indicated in Note 3), is V_{TT} .
19. t_{HZ} and t_{LZ} transitions occur in the same access time windows as data valid transitions. These parameters are not referenced to a specific voltage level, but specify when the device output is no longer driving (High-Z) or begins driving (Low-Z).
20. The intent of the “Don’t Care” state after completion of the postamble is the DQS-driven signal should either be HIGH, LOW, or High-Z, and that any signal transition within the input switching region must follow valid input requirements. That is, if DQS transitions HIGH (above $V_{IH}[DC]$ MIN) then it must not transition LOW (below $V_{IH}[DC]$) prior to t_{DQSH} [MIN].
21. This is not a device limit. The device will operate with a negative value, but system performance could be degraded due to bus turnaround.
22. It is recommended that DQS be valid (HIGH or LOW) on or before the WRITE command. The case shown (DQS going from High-Z to logic LOW) applies when no WRITES were previously in progress on the bus. If a previous WRITE was in progress, DQS could be HIGH during this time, depending on t_{DQSS} .
23. MIN (t_{RC} or t_{RFC}) for I_{DD} measurements is the smallest multiple of t_{CK} that meets the minimum absolute value for the respective parameter. t_{RAS} (MAX) for I_{DD} measurements is the largest multiple of t_{CK} that meets the maximum absolute value for t_{RAS} .
24. The refresh period is 64ms (commercial and industrial) or 16ms (automotive). This equates to an average refresh rate of 7.8125 μ s (commercial and industrial) or 1.95 μ s (automotive). However, an AUTO REFRESH command must be asserted at least once every 70.3 μ s (commercial and industrial) or 17.55 μ s (automotive); burst refreshing or posting by the DRAM controller greater than 8 REFRESH cycles is not allowed.
25. The I/O capacitance per DQS and DQ byte/group will not differ by more than this maximum amount for any given device.
26. The data valid window is derived by achieving other specifications: t_{HP} ($t_{CK}/2$), t_{DQSQ} , and t_{QH} ($t_{QH} = t_{HP} - t_{QHS}$). The data valid window derates in direct proportion to the clock duty cycle and a practical data valid window can be derived. The clock is allowed a maximum duty cycle variation of 45/55, because functionality is uncertain when operating beyond a 45/55 ratio. The data valid window derating curves are provided in Figure 12 on page 37 for duty cycles ranging between 50/50 and 45/55.
27. Referenced to each output group: x4 = DQS with DQ0–DQ3; x8 = DQS with DQ0–DQ7; x16 = LDQS with DQ0–DQ7 and UDQS with DQ8–DQ15.
28. This limit is actually a nominal value and does not result in a fail value. CKE is HIGH during the REFRESH command period (t_{RFC} [MIN]), else CKE is LOW (that is, during standby).
29. To maintain a valid level, the transitioning edge of the input must:
 - 29a. Sustain a constant slew rate from the current AC level through to the target AC level, $V_{IL}(AC)$ or $V_{IH}(AC)$.
 - 29b. Reach at least the target AC level.
 - 29c. After the AC target level is reached, continue to maintain at least the target DC level, $V_{IL}(DC)$ or $V_{IH}(DC)$.

- 30. The input capacitance per pin group will not differ by more than this maximum amount for any given device.
- 31. CK and CK# input slew rate must be ≥ 1 V/ns (≥ 2 V/ns if measured differentially).

Figure 12: Derating Data Valid Window ($t_{QH} - t_{DQSQ}$)

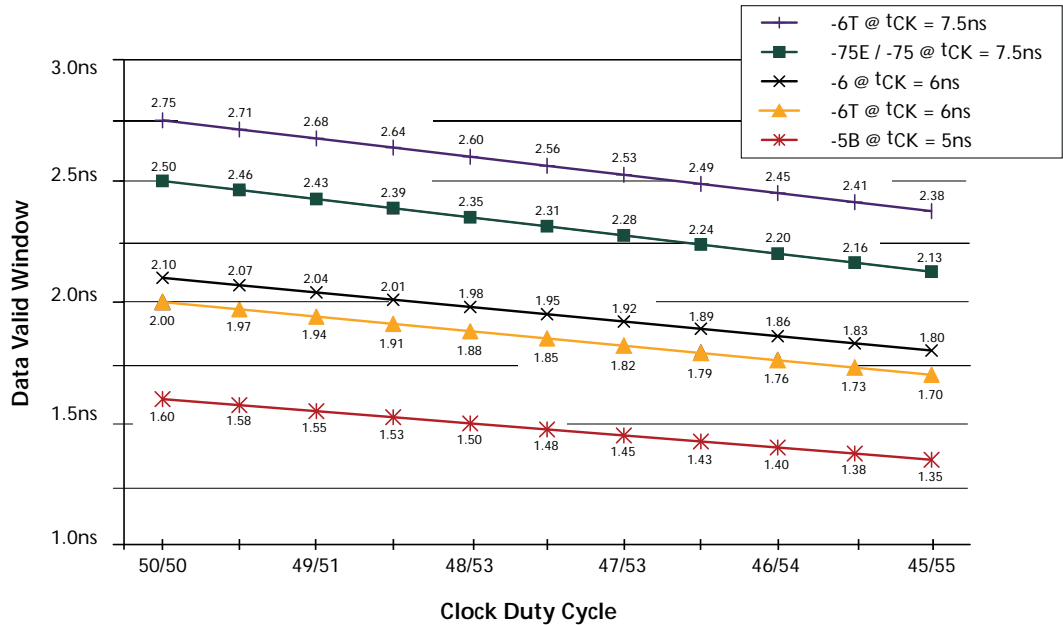

- 32. DQ and DM input slew rates must not deviate from DQS by more than 10%. If the DQ/DM/DQS slew rate is less than 0.5 V/ns, timing must be derated: 50ps must be added to t_{DS} and t_{DH} for each 100 mV/ns reduction in slew rate. For -5B, -6, and -6T speed grades, the slew rate must be ≥ 0.5 V/ns. If the slew rate exceeds 4 V/ns, functionality is uncertain.
- 33. VDD must not vary more than 4% if CKE is not active while any bank is active.
- 34. The clock is allowed up to ± 150 ps of jitter. Each timing parameter is allowed to vary by the same amount.
- 35. t_{HP} (MIN) is the lesser of t_{CL} (MIN) and t_{CH} (MIN) actually applied to the device CK and CK# inputs, collectively, during bank active.
- 36. READs and WRITEs with auto precharge are not allowed to be issued until t_{RAS} (MIN) can be satisfied prior to the internal PRECHARGE command being issued.
- 37. Any positive glitch must be less than 1/3 of the clock cycle and not more than +400mV or 2.9V (+300mV or 2.9V maximum for -5B), whichever is less. Any negative glitch must be less than 1/3 of the clock cycle and not exceed either -300mV or 2.2V (2.4V for -5B), whichever is more positive. The average cannot be below the +2.5V (2.6V for -5B) minimum.
- 38. Normal output drive curves:
 - 38a. The full driver pull-down current variation from MIN to MAX process; temperature and voltage will lie within the outer bounding lines of the V-I curve of Figure 13 on page 38.
 - 38b. The driver pull-down current variation, within nominal voltage and temperature limits, is expected, but not guaranteed, to lie within the inner bounding lines of the V-I curve of Figure 13 on page 38.

- 38c. The full driver pull-up current variation from MIN to MAX process; temperature and voltage will lie within the outer bounding lines of the V-I curve of Figure 14 on page 38.
- 38d. The driver pull-up current variation within nominal limits of voltage and temperature is expected, but not guaranteed, to lie within the inner bounding lines of the V-I curve of Figure 14 on page 38.
- 38e. The full ratio variation of MAX to MIN pull-up and pull-down current should be between 0.71 and 1.4 for drain-to-source voltages from 0.1V to 1.0V at the same voltage and temperature.
- 38f. The full ratio variation of the nominal pull-up to pull-down current should be unity $\pm 10\%$ for device drain-to-source voltages from 0.1V to 1.0V.

Figure 13: Full Drive Pull-Down Characteristics

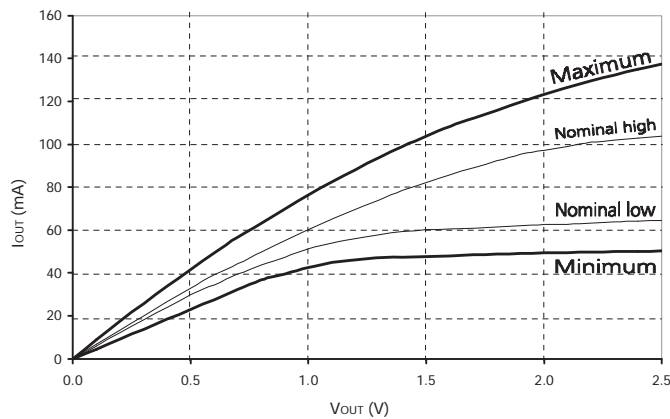
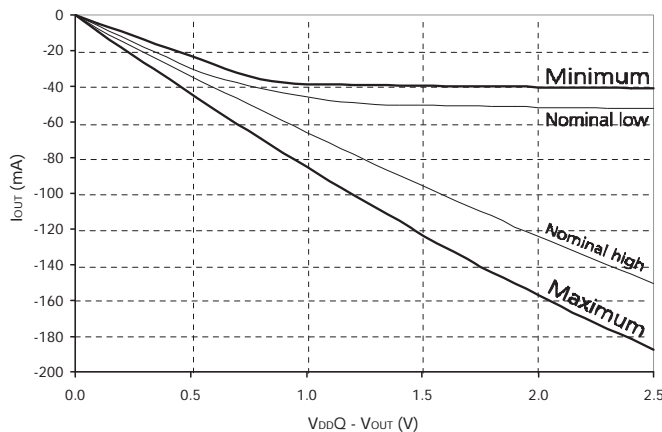

Figure 14: Full Drive Pull-Up Characteristics



39. Reduced output drive curves:

- 39a. The full driver pull-down current variation from MIN to MAX process; temperature and voltage will lie within the outer bounding lines of the V-I curve of Figure 15 on page 39.
- 39b. The driver pull-down current variation, within nominal voltage and temperature limits, is expected, but not guaranteed, to lie within the inner bounding lines of the V-I curve of Figure 15 on page 39.
- 39c. The full driver pull-up current variation from MIN to MAX process; temperature and voltage will lie within the outer bounding lines of the V-I curve of Figure 16.

- 39d. The driver pull-up current variation, within nominal voltage and temperature limits, is expected, but not guaranteed, to lie within the inner bounding lines of the V-I curve of Figure 16 on page 39.
- 39e. The full ratio variation of the MAX-to-MIN pull-up and pull-down current should be between 0.71 and 1.4 for device drain-to-source voltages from 0.1V to 1.0V at the same voltage and temperature.
- 39f. The full ratio variation of the nominal pull-up to pull-down current should be unity $\pm 10\%$, for device drain-to-source voltages from 0.1V to 1.0V.

Figure 15: Reduced Drive Pull-Down Characteristics

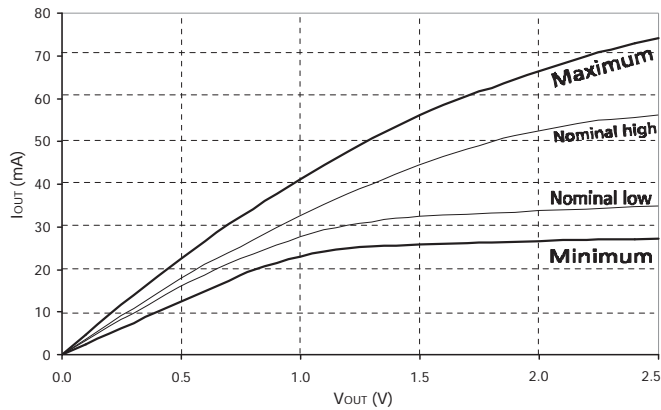
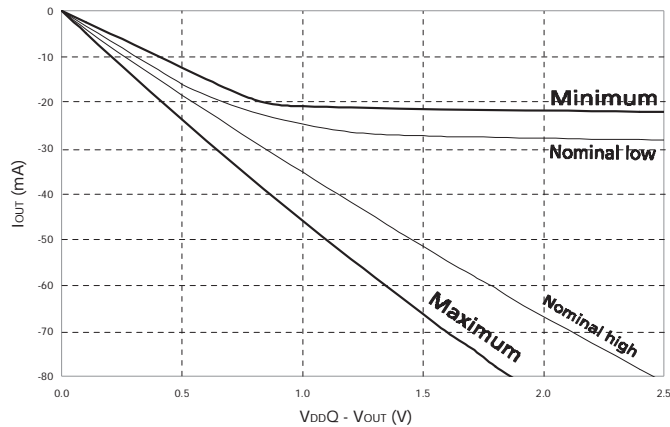

Figure 16: Reduced Drive Pull-Up Characteristics



- 40. The voltage levels used are derived from a minimum VDD level and the referenced test load. In practice, the voltage levels obtained from a properly terminated bus will provide significantly different voltage values.
- 41. VIH overshoot: $V_{IH} (MAX) = V_{DDQ} + 1.5V$ for a pulse width $\leq 3ns$, and the pulse width can not be greater than 1/3 of the cycle rate. VIL undershoot: $V_{IL} (MIN) = -1.5V$ for a pulse width $\leq 3ns$, and the pulse width can not be greater than 1/3 of the cycle rate.
- 42. VDD and VDDQ must track each other.
- 43. $t_{HZ} (MAX)$ will prevail over $t_{DQSCK} (MAX) + t_{RPST} (MAX)$ condition. $t_{LZ} (MIN)$ will prevail over $t_{DQSCK} (MIN) + t_{RPRE} (MAX)$ condition.

44. t_{RPST} end point and t_{RPRE} begin point are not referenced to a specific voltage level but specify when the device output is no longer driving (t_{RPST}) or begins driving (t_{RPRE}).
45. During initialization, V_{DDQ} , V_{TT} , and V_{REF} must be equal to or less than $V_{DD} + 0.3V$. Alternatively, V_{TT} may be 1.35V maximum during power-up, even if V_{DD}/V_{DDQ} are 0V, provided a minimum of 42Ω of series resistance is used between the V_{TT} supply and the input pin.
46. The current Micron part operates below 83 MHz (slowest specified JEDEC operating frequency). As such, future die may not reflect this option.
47. When an input signal is HIGH or LOW, it is defined as a steady state logic HIGH or LOW.
48. Random address is changing; 50% of data is changing at every transfer.
49. Random address is changing; 100% of data is changing at every transfer.
50. CKE must be active (HIGH) during the entire time a REFRESH command is executed. That is, from the time the AUTO REFRESH command is registered, CKE must be active at each rising clock edge, until t_{RFC} has been satisfied.
51. $IDD2N$ specifies the DQ, DQS, and DM to be driven to a valid HIGH or LOW logic level. $IDD2Q$ is similar to $IDD2F$ except $IDD2Q$ specifies the address and control inputs to remain stable. Although $IDD2F$, $IDD2N$, and $IDD2Q$ are similar, $IDD2F$ is “worst case.”
52. Whenever the operating frequency is altered, not including jitter, the DLL is required to be reset followed by 200 clock cycles before any READ command.
53. This is the DC voltage supplied at the DRAM and is inclusive of all noise up to 20 MHz. Any noise above 20 MHz at the DRAM generated from any source other than that of the DRAM itself may not exceed the DC voltage range of $2.6V \pm 100mV$.
54. The -6/-6T speed grades will operate with $t_{RAS} (MIN) = 40ns$ and $t_{RAS} (MAX) = 120,000ns$ at any slower frequency.

Table 26: Normal Output Drive Characteristics

Characteristics are specified under best, worst, and nominal process variation/conditions

Voltage (V)	Pull-Down Current (mA)				Pull-Up Current (mA)			
	Nominal Low	Nominal High	Min	Max	Nominal Low	Nominal High	Min	Max
0.1	6.0	6.8	4.6	9.6	-6.1	-7.6	-4.6	-10.0
0.2	12.2	13.5	9.2	18.2	-12.2	-14.5	-9.2	-20.0
0.3	18.1	20.1	13.8	26.0	-18.1	-21.2	-13.8	-29.8
0.4	24.1	26.6	18.4	33.9	-24.0	-27.7	-18.4	-38.8
0.5	29.8	33.0	23.0	41.8	-29.8	-34.1	-23.0	-46.8
0.6	34.6	39.1	27.7	49.4	-34.3	-40.5	-27.7	-54.4
0.7	39.4	44.2	32.2	56.8	-38.1	-46.9	-32.2	-61.8
0.8	43.7	49.8	36.8	63.2	-41.1	-53.1	-36.0	-69.5
0.9	47.5	55.2	39.6	69.9	-43.8	-59.4	-38.2	-77.3
1.0	51.3	60.3	42.6	76.3	-46.0	-65.5	-38.7	-85.2
1.1	54.1	65.2	44.8	82.5	-47.8	-71.6	-39.0	-93.0
1.2	56.2	69.9	46.2	88.3	-49.2	-77.6	-39.2	-100.6
1.3	57.9	74.2	47.1	93.8	-50.0	-83.6	-39.4	-108.1
1.4	59.3	78.4	47.4	99.1	-50.5	-89.7	-39.6	-115.5
1.5	60.1	82.3	47.7	103.8	-50.7	-95.5	-39.9	-123.0
1.6	60.5	85.9	48.0	108.4	-51.0	-101.3	-40.1	-130.4
1.7	61.0	89.1	48.4	112.1	-51.1	-107.1	-40.2	-136.7
1.8	61.5	92.2	48.9	115.9	-51.3	-112.4	-40.3	-144.2
1.9	62.0	95.3	49.1	119.6	-51.5	-118.7	-40.4	-150.5
2.0	62.5	97.2	49.4	123.3	-51.6	-124.0	-40.5	-156.9
2.1	62.8	99.1	49.6	126.5	-51.8	-129.3	-40.6	-163.2
2.2	63.3	100.9	49.8	129.5	-52.0	-134.6	-40.7	-169.6
2.3	63.8	101.9	49.9	132.4	-52.2	-139.9	-40.8	-176.0
2.4	64.1	102.8	50.0	135.0	-52.3	-145.2	-40.9	-181.3
2.5	64.6	103.8	50.2	137.3	-52.5	-150.5	-41.0	-187.6
2.6	64.8	104.6	50.4	139.2	-52.7	-155.3	-41.1	-192.9
2.7	65.0	105.4	50.5	140.8	-52.8	-160.1	-41.2	-198.2

Table 27: Reduced Output Drive Characteristics

Characteristics are specified under best, worst, and nominal process variation/conditions

Voltage (V)	Pull-Down Current (mA)				Pull-Up Current (mA)			
	Nominal Low	Nominal High	Min	Max	Nominal Low	Nominal High	Min	Max
0.1	3.4	3.8	2.6	5.0	-3.5	-4.3	-2.6	-5.0
0.2	6.9	7.6	5.2	9.9	-6.9	-7.8	-5.2	-9.9
0.3	10.3	11.4	7.8	14.6	-10.3	-12.0	-7.8	-14.6
0.4	13.6	15.1	10.4	19.2	-13.6	-15.7	-10.4	-19.2
0.5	16.9	18.7	13.0	23.6	-16.9	-19.3	-13.0	-23.6
0.6	19.9	22.1	15.7	28.0	-19.4	-22.9	-15.7	-28.0
0.7	22.3	25.0	18.2	32.2	-21.5	-26.5	-18.2	-32.2
0.8	24.7	28.2	20.8	35.8	-23.3	-30.1	-20.4	-35.8
0.9	26.9	31.3	22.4	39.5	-24.8	-33.6	-21.6	-39.5
1.0	29.0	34.1	24.1	43.2	-26.0	-37.1	-21.9	-43.2
1.1	30.6	36.9	25.4	46.7	-27.1	-40.3	-22.1	-46.7
1.2	31.8	39.5	26.2	50.0	-27.8	-43.1	-22.2	-50.0
1.3	32.8	42.0	26.6	53.1	-28.3	-45.8	-22.3	-53.1
1.4	33.5	44.4	26.8	56.1	-28.6	-48.4	-22.4	-56.1
1.5	34.0	46.6	27.0	58.7	-28.7	-50.7	-22.6	-58.7
1.6	34.3	48.6	27.2	61.4	-28.9	-52.9	-22.7	-61.4
1.7	34.5	50.5	27.4	63.5	-28.9	-55.0	-22.7	-63.5
1.8	34.8	52.2	27.7	65.6	-29.0	-56.8	-22.8	-65.6
1.9	35.1	53.9	27.8	67.7	-29.2	-58.7	-22.9	-67.7
2.0	35.4	55.0	28.0	69.8	-29.2	-60.0	-22.9	-69.8
2.1	35.6	56.1	28.1	71.6	-29.3	-61.2	-23.0	-71.6
2.2	35.8	57.1	28.2	73.3	-29.5	-62.4	-23.0	-73.3
2.3	36.1	57.7	28.3	74.9	-29.5	-63.1	-23.1	-74.9
2.4	36.3	58.2	28.3	76.4	-29.6	-63.8	-23.2	-76.4
2.5	36.5	58.7	28.4	77.7	-29.7	-64.4	-23.2	-77.7
2.6	36.7	59.2	28.5	78.8	-29.8	-65.1	-23.3	-78.8
2.7	36.8	59.6	28.6	79.7	-29.9	-65.8	-23.3	-79.7

Commands

Tables 28 and 29 provide a quick reference of available commands. Two additional Truth Tables—Table 30 on page 44 and Table 31 on page 45—provide current state/next state information.

Table 28: Truth Table 1 – Commands

CKE is HIGH for all commands shown except SELF REFRESH; All states and sequences not shown are illegal or reserved

Function	CS#	RAS#	CAS#	WE#	Address	Notes
DESELECT	H	X	X	X	X	1
NO OPERATION (NOP)	L	H	H	H	X	1
ACTIVE (select bank and activate row)	L	L	H	H	Bank/row	2
READ (select bank and column and start READ burst)	L	H	L	H	Bank/col	3
WRITE (select bank and column and start WRITE burst)	L	H	L	L	Bank/col	3
BURST TERMINATE	L	H	H	L	X	4
PRECHARGE (deactivate row in bank or banks)	L	L	H	L	Code	5
AUTO REFRESH or SELF REFRESH (enter self refresh mode)	L	L	L	H	X	6, 7
LOAD MODE REGISTER	L	L	L	L	Op-code	8

- Notes:
1. Deselect and NOP are functionally interchangeable.
 2. BA0–BA1 provide bank address and A0–A_n (128Mb: $n = 11$; 256Mb and 512Mb: $n = 12$; 1Gb: $n = 13$) provide row address.
 3. BA0–BA1 provide bank address; A0–A_i provide column address, (where A_i is the most significant column address bit for a given density and configuration, see Table 2 on page 2) A10 HIGH enables the auto precharge feature (non persistent), and A10 LOW disables the auto precharge feature.
 4. Applies only to READ bursts with auto precharge disabled; this command is undefined (and should not be used) for READ bursts with auto precharge enabled and for WRITE bursts.
 5. A10 LOW: BA0–BA1 determine which bank is precharged. A10 HIGH: all banks are precharged and BA0–BA1 are “Don’t Care.”
 6. This command is AUTO REFRESH if CKE is HIGH; SELF REFRESH if CKE is LOW.
 7. Internal refresh counter controls row addressing while in self refresh mode, all inputs and I/Os are “Don’t Care” except for CKE.
 8. BA0–BA1 select either the mode register or the extended mode register (BA0 = 0, BA1 = 0 select the mode register; BA0 = 1, BA1 = 0 select extended mode register; other combinations of BA0–BA1 are reserved). A0–A_n provide the op-code to be written to the selected mode register.

Table 29: Truth Table 2 – DM Operation

Used to mask write data, provided coincident with the corresponding data

Name (Function)	DM	DQ
Write enable	L	Valid
Write inhibit	H	X

Table 30: Truth Table 3 – Current State Bank *n* – Command to Bank *n*

Notes: 1–6 apply to the entire table; Notes appear below

Current State	CS#	RAS#	CAS#	WE#	Command/Action	Notes
Any	H	X	X	X	DESELECT (NOP/continue previous operation)	
	L	H	H	H	NO OPERATION (NOP/continue previous operation)	
Idle	L	L	H	H	ACTIVE (select and activate row)	
	L	L	L	H	AUTO REFRESH	7
	L	L	L	L	LOAD MODE REGISTER	7
Row active	L	H	L	H	READ (select column and start READ burst)	10
	L	H	L	L	WRITE (select column and start WRITE burst)	10
	L	L	H	L	PRECHARGE (deactivate row in bank or banks)	8
Read (auto precharge disabled)	L	H	L	H	READ (select column and start new READ burst)	10
	L	H	L	L	WRITE (select column and start WRITE burst)	10, 12
	L	L	H	L	PRECHARGE (truncate READ burst, start PRECHARGE)	8
	L	H	H	L	BURST TERMINATE	9
Write (auto precharge disabled)	L	H	L	H	READ (select column and start READ burst)	10, 11
	L	H	L	L	WRITE (select column and start new WRITE burst)	10
	L	L	H	L	PRECHARGE (truncate WRITE burst, start PRECHARGE)	8, 11

- Notes:
- This table applies when CKE_{n-1} was HIGH and CKE_n is HIGH (see Table 33 on page 47) and after t^1XSNR has been met (if the previous state was self refresh).
 - This table is bank-specific, except where noted (that is, the current state is for a specific bank and the commands shown are those allowed to be issued to that bank when in that state). Exceptions are covered in the notes below.
 - Current state definitions:
 - Idle: The bank has been precharged, and t^1RP has been met.
 - Row active: A row in the bank has been activated, and t^1RCD has been met. No data bursts/accesses and no register accesses are in progress.
 - Read: A READ burst has been initiated, with auto precharge disabled, and has not yet terminated or been terminated.
 - Write: A WRITE burst has been initiated, with auto precharge disabled, and has not yet terminated or been terminated.
 - The following states must not be interrupted by a command issued to the same bank. COMMAND INHIBIT or NOP commands, or allowable commands to the other bank should be issued on any clock edge occurring during these states. Allowable commands to the other bank are determined by its current state and Table 30 and according to Table 31 on page 45.
 - Precharging: Starts with registration of a PRECHARGE command and ends when t^1RP is met. Once t^1RP is met, the bank will be in the idle state.
 - Row activating: Starts with registration of an ACTIVE command and ends when t^1RCD is met. Once t^1RCD is met, the bank will be in the “row active” state.
 - Read with auto precharge enabled: Starts with registration of a READ command with auto precharge enabled and ends when t^1RP has been met. Once t^1RP is met, the bank will be in the idle state.
 - Write with auto precharge enabled: Starts with registration of a WRITE command with auto precharge enabled and ends when t^1RP has been met. Once t^1RP is met, the bank will be in the idle state.
 - The following states must not be interrupted by any executable command; COMMAND INHIBIT or NOP commands must be applied on each positive clock edge during these states.

- Refreshing: Starts with registration of an AUTO REFRESH command and ends when t_{RFC} is met. Once t_{RFC} is met, the DDR SDRAM will be in the all banks idle state.
 - Accessing mode register: Starts with registration of an LMR command and ends when t_{MRD} has been met. Once t_{MRD} is met, the DDR SDRAM will be in the all banks idle state.
 - Precharging all: Starts with registration of a PRECHARGE ALL command and ends when t_{RP} is met. Once t_{RP} is met, all banks will be in the idle state.
6. All states and sequences not shown are illegal or reserved.
 7. Not bank-specific; requires that all banks are idle, and bursts are not in progress.
 8. May or may not be bank-specific; if multiple banks are to be precharged, each must be in a valid state for precharging.
 9. Not bank-specific; BURST TERMINATE affects the most recent READ burst, regardless of bank.
 10. READs or WRITEs listed in the Command/Action column include READs or WRITEs with auto precharge enabled and READs or WRITEs with auto precharge disabled.
 11. Requires appropriate DM masking.
 12. A WRITE command may be applied after the completion of the READ burst; otherwise, a BURST TERMINATE must be used to end the READ burst prior to asserting a WRITE command.

Table 31: Truth Table 4 – Current State Bank n – Command to Bank m

Notes: 1–6 apply to the entire table; Notes appear on page 45

Current State	CS#	RAS#	CAS#	WE#	Command/Action	Notes
Any	H	X	X	X	DESELECT (NOP/continue previous operation)	
	L	H	H	H	NO OPERATION (NOP/continue previous operation)	
Idle	X	X	X	X	Any command otherwise allowed to bank m	
Row activating, active, or precharging	L	L	H	H	ACTIVE (select and activate row)	
	L	H	L	H	READ (select column and start READ burst)	7
	L	H	L	L	WRITE (select column and start WRITE burst)	7
	L	L	H	L	PRECHARGE	
Read (auto precharge disabled)	L	L	H	H	ACTIVE (select and activate row)	
	L	H	L	H	READ (select column and start new READ burst)	7
	L	H	L	L	WRITE (select column and start WRITE burst)	7, 9
	L	L	H	L	PRECHARGE	
Write (auto precharge disabled)	L	L	H	H	ACTIVE (select and activate row)	
	L	H	L	H	READ (select column and start READ burst)	7, 8
	L	H	L	L	WRITE (select column and start new WRITE burst)	7
	L	L	H	L	PRECHARGE	
Read (with auto-precharge)	L	L	H	H	ACTIVE (select and activate row)	
	L	H	L	H	READ (select column and start new READ burst)	7
	L	H	L	L	WRITE (select column and start WRITE burst)	7, 9
	L	L	H	L	PRECHARGE	
Write (with auto-precharge)	L	L	H	H	ACTIVE (select and activate row)	
	L	H	L	H	READ (select column and start READ burst)	7
	L	H	L	L	WRITE (select column and start new WRITE burst)	7
	L	L	H	L	PRECHARGE	

 Notes: 1. This table applies when CKE_{n-1} was HIGH and CKE_n is HIGH (see Table 33 on page 47) and after t_{XSNR} has been met (if the previous state was self refresh).

2. This table describes alternate bank operation, except where noted (that is, the current state is for bank n , and the commands shown are those allowed to be issued to bank m , assuming that bank m is in such a state that the given command is allowable). Exceptions are covered in the notes below.
3. Current state definitions:
 - Idle: The bank has been precharged, and t_{RP} has been met.
 - Row active: A row in the bank has been activated, and t_{RCD} has been met. No data bursts/accesses and no register accesses are in progress.
 - Read: A READ burst has been initiated, with auto precharge disabled, and has not yet terminated or been terminated.
 - Write: A WRITE burst has been initiated, with auto precharge disabled, and has not yet terminated or been terminated.
 - Read with auto precharge enabled: See note 3a below.
 - Write with auto precharge enabled: See note 3a below.
 - a. The read with auto precharge enabled or write with auto precharge enabled states can each be broken into two parts: the access period and the precharge period. For read with auto precharge, the precharge period is defined as if the same burst was executed with auto precharge disabled and then followed with the earliest possible PRECHARGE command that still accesses all of the data in the burst. For write with auto precharge, the precharge period begins when t_{WR} ends, with t_{WR} measured as if auto precharge was disabled. The access period starts with registration of the command and ends where the precharge period (or t_{RP}) begins. This device supports concurrent auto precharge such that when a read with auto precharge is enabled or a write with auto precharge is enabled, any command to other banks is allowed, as long as that command does not interrupt the read or write data transfer already in process. In either case, all other related limitations apply (for example, contention between read data and write data must be avoided).
 - b. The minimum delay from a READ or WRITE command with auto precharge enabled, to a command to a different bank is summarized in Table 32.

Table 32: Command Delays
 $CL_{RJ} = CL$ rounded up to the next integer

From Command	To Command	Minimum Delay with Concurrent Auto Precharge
WRITE with auto precharge	READ or READ with auto precharge	$[1 + (BL/2)] \times t_{CK} + t_{WTR}$
	WRITE or WRITE with auto precharge	$(BL/2) \times t_{CK}$
	PRECHARGE	$1 t_{CK}$
	ACTIVE	$1 t_{CK}$
READ with auto precharge	READ or READ with auto precharge	$(BL/2) \times t_{CK}$
	WRITE or WRITE with auto precharge	$[CL_{RJ} + (BL/2)] \times t_{CK}$
	PRECHARGE	$1 t_{CK}$
	ACTIVE	$1 t_{CK}$

4. AUTO REFRESH and LMR commands may only be issued when all banks are idle.
5. A BURST TERMINATE command cannot be issued to another bank; it applies to the bank represented by the current state only.
6. All states and sequences not shown are illegal or reserved.
7. READs or WRITEs listed in the "Command/Action" column include READs or WRITEs with auto precharge enabled and READs or WRITEs with auto precharge disabled.
8. Requires appropriate DM masking.
9. A WRITE command may be applied after the completion of the READ burst; otherwise, a BURST TERMINATE must be used to end the READ burst prior to asserting a WRITE command.

Table 33: Truth Table 5 – CKE

Notes 1–6 apply to the entire table; Notes appear below

CKE _{n-1}	CKE _n	Current State	Command _n	Action _n	Notes
L	L	Power-down	X	Maintain power-down	
		Self refresh	X	Maintain self refresh	
L	H	Power-down	DESELECT or NOP	Exit power-down	
		Self refresh	DESELECT or NOP	Exit self refresh	7
H	L	All banks idle	DESELECT or NOP	Precharge power-down entry	
		Bank(s) active	DESELECT or NOP	Active power-down entry	
		All banks idle	AUTO REFRESH	Self refresh entry	
H	H		See Table 28 on page 43		

- Notes:
1. CKE_n is the logic state of CKE at clock edge *n*; CKE_{n-1} was the state of CKE at the previous clock edge.
 2. Current state is the state of the DDR SDRAM immediately prior to clock edge *n*.
 3. COMMAND_n is the command registered at clock edge *n*, and ACTION_n is a result of COMMAND_n.
 4. All states and sequences not shown are illegal or reserved.
 5. CKE must not drop LOW during a column access. For a READ, this means CKE must stay HIGH until after the read postamble time (^tRPST); for a WRITE, CKE must stay HIGH until the write recovery time (^tWR) has been met.
 6. Once initialized, including during self refresh mode, VREF must be powered within the specified range.
 7. Upon exit of the self refresh mode, the DLL is automatically enabled. A minimum of 200 clock cycles is needed before applying a READ command for the DLL to lock. Deselect or NOP commands should be issued on any clock edges occurring during the ^tXSNR period.

DESELECT

The Deselect function (CS# HIGH) prevents new commands from being executed by the DDR SDRAM. The DDR SDRAM is effectively deselected. Operations already in progress are not affected.

NO OPERATION (NOP)

The NO OPERATION (NOP) command is used to instruct the selected DDR SDRAM to perform a NOP (CS# is LOW with RAS#, CAS#, and WE# are HIGH). This prevents unwanted commands from being registered during idle or wait states. Operations already in progress are not affected.

LOAD MODE REGISTER (LMR)

The mode registers are loaded via inputs A0–An (see "REGISTER DEFINITION" on page 55). The LMR command can only be issued when all banks are idle, and a subsequent executable command cannot be issued until ^tMRD is met.

ACTIVE (ACT)

The ACTIVE command is used to open (or activate) a row in a particular bank for a subsequent access, like a read or a write, as shown in Figure 17. The value on the BA0, BA1 inputs selects the bank, and the address provided on inputs A0–An selects the row.

Figure 17: Activating a Specific Row in a Specific Bank

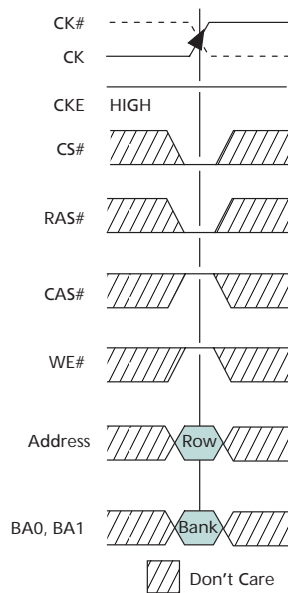

READ

The READ command is used to initiate a burst read access to an active row, as shown in Figure 18 on page 49. The value on the BA0, BA1 inputs selects the bank, and the address provided on inputs A0–Ai (where Ai is the most significant column address bit for a given density and configuration, see Table 2 on page 2) selects the starting column location.

Figure 18: READ Command

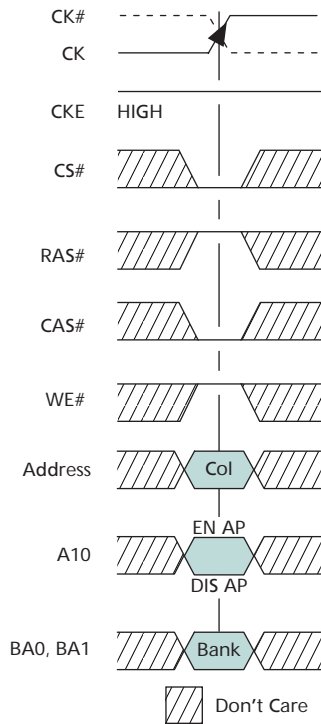

Note: EN AP = enable auto precharge; DIS AP = disable auto precharge.

WRITE

The WRITE command is used to initiate a burst write access to an active row as shown in Figure 19. The value on the BA0, BA1 inputs selects the bank, and the address provided on inputs A0–Ai (where Ai is the most significant column address bit for a given density and configuration, see Table 2 on page 2) selects the starting column location.

Figure 19: WRITE Command

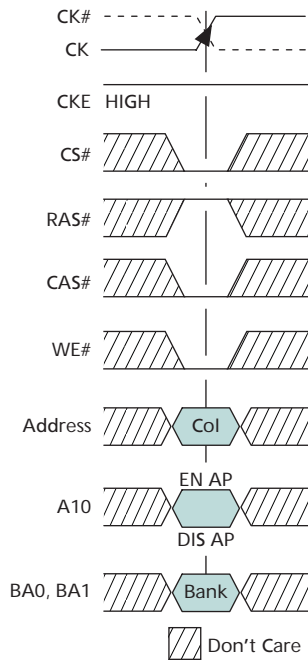

Note: EN AP = enable auto precharge; and DIS AP = disable auto precharge.

PRECHARGE (PRE)

The PRECHARGE command is used to deactivate the open row in a particular bank or the open row in all banks as shown in Figure 20. The value on the BA0, BA1 inputs selects the bank, and the A10 input selects whether a single bank is precharged or whether all banks are precharged.

Figure 20: PRECHARGE Command

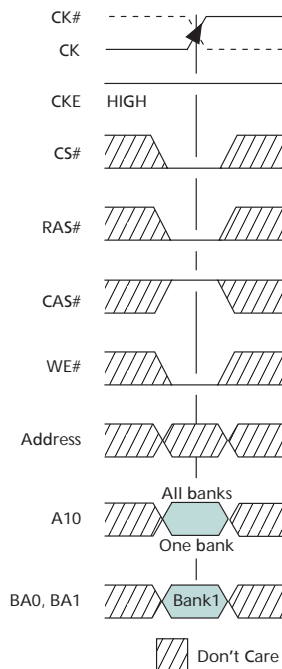

Notes: 1. If A10 is HIGH, bank address becomes "Don't Care."

BURST TERMINATE (BST)

The BURST TERMINATE command is used to truncate READ bursts (with auto precharge disabled). The most recently registered READ command prior to the BURST TERMINATE command will be truncated, as shown in "Operations" on page 52. The open page from which the READ burst was terminated remains open.

AUTO REFRESH (AR)

AUTO REFRESH is used during normal operation of the DDR SDRAM and is analogous to CAS#-before-RAS# (CBR) refresh in FPM/EDO DRAMs. This command is nonpersistent, so it must be issued each time a refresh is required. All banks must be idle before an AUTO REFRESH command is issued.

SELF REFRESH

The SELF REFRESH command can be used to retain data in the DDR SDRAM, even if the rest of the system is powered down. The SELF REFRESH command is initiated like an AUTO REFRESH command except CKE is disabled (LOW).

Self refresh is not supported on automotive temperature (AT) devices.

Operations

INITIALIZATION

Prior to normal operation, DDR SDRAMs must be powered up and initialized in a predefined manner. Operational procedures, other than those specified, may result in undefined operation.

To ensure device operation, the DRAM must be initialized as described in the following steps:

1. Simultaneously apply power to VDD and VDDQ.
2. Apply VREF and then VTT power. VTT must be applied after VDDQ to avoid device latch-up, which may cause permanent damage to the device. Except for CKE, inputs are not recognized as valid until after VREF is applied.
3. Assert and hold CKE at a LVC MOS logic LOW. Maintaining an LVC MOS LOW level on CKE during power-up is required to ensure that the DQ and DQS outputs will be in the High-Z state, where they will remain until driven in normal operation (by a read access).
4. Provide stable clock signals.
5. Wait at least 200 μ s.
6. Bring CKE HIGH, and provide at least one NOP or DESELECT command. At this point, the CKE input changes from a LVC MOS input to a SSTL_2 input only and will remain a SSTL_2 input unless a power cycle occurs.
7. Perform a PRECHARGE ALL command.
8. Wait at least t_{RP} time; during this time NOPs or DESELECT commands must be given.
9. Using the LMR command, program the extended mode register (E0 = 0 to enable the DLL and E1 = 0 for normal drive; or E1 = 1 for reduced drive and E2–En must be set to 0 [where n = most significant bit]).
10. Wait at least t_{MRD} time; only NOPs or DESELECT commands are allowed.
11. Using the LMR command, program the mode register to set operating parameters and to reset the DLL. At least 200 clock cycles are required between a DLL reset and any READ command.
12. Wait at least t_{MRD} time; only NOPs or DESELECT commands are allowed.
13. Issue a PRECHARGE ALL command.
14. Wait at least t_{RP} time; only NOPs or DESELECT commands are allowed.
15. Issue an AUTO REFRESH command. This may be moved prior to step 13.
16. Wait at least t_{RFC} time; only NOPs or DESELECT commands are allowed.
17. Issue an AUTO REFRESH command. This may be moved prior to step 13.
18. Wait at least t_{RFC} time; only NOPs or DESELECT commands are allowed.
19. Although not required by the Micron device, JEDEC requires an LMR command to clear the DLL bit (set M8 = 0). If an LMR command is issued, the same operating parameters should be utilized as in step 11.
20. Wait at least t_{MRD} time; only NOPs or DESELECT commands are supported.
21. At this point the DRAM is ready for any valid command. At least 200 clock cycles with CKE HIGH are required between step 11 (DLL RESET) and any READ command.

Figure 21: INITIALIZATION Flow Diagram

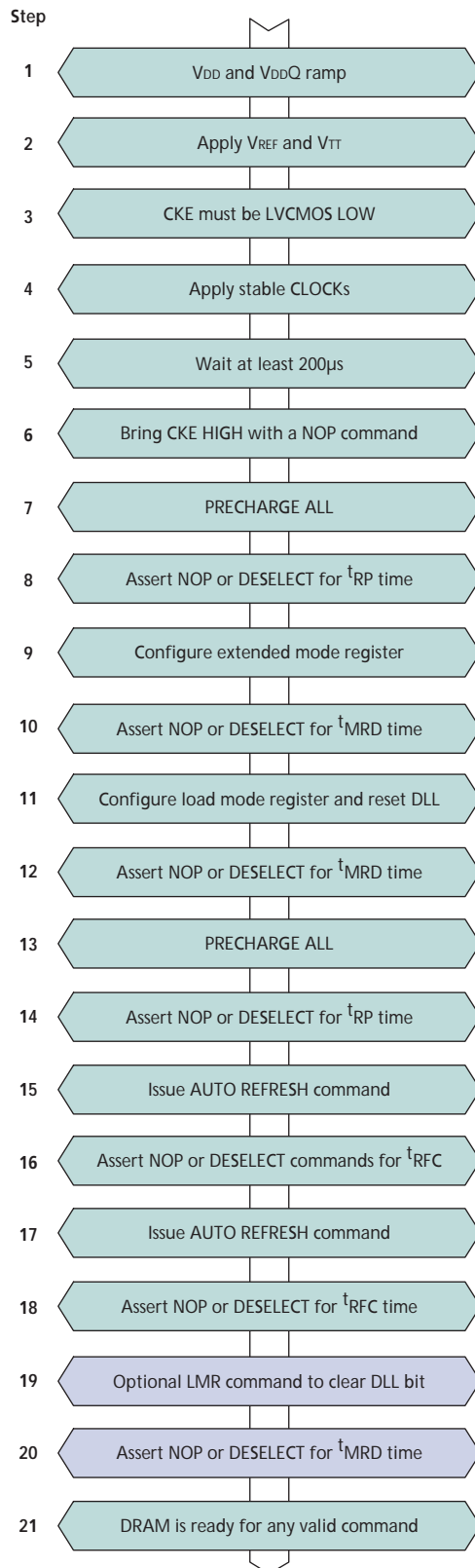
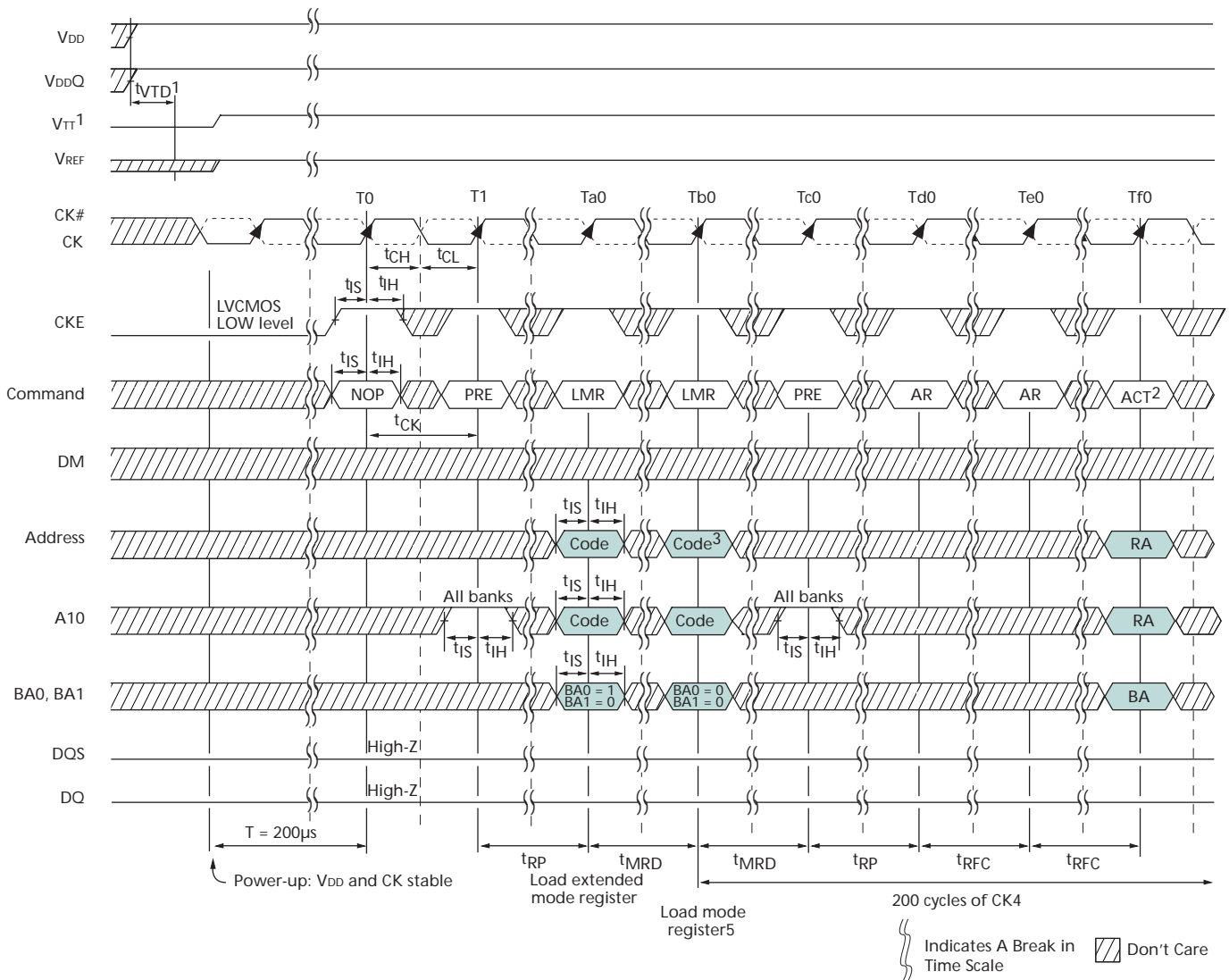

Figure 22: INITIALIZATION Timing Diagram



- Notes:
1. V_{TT} is not applied directly to the device; however, $V_{TVD} \geq 0$ to avoid device latch-up. V_{DDQ} , V_{TT} , and $V_{REF} \leq V_{DD} + 0.3V$. Alternatively, V_{TT} may be 1.35V maximum during power-up, even if V_{DD}/V_{DDQ} are 0V, provided a minimum of 42Ω of series resistance is used between the V_{TT} supply and the input pin. Once initialized, V_{REF} must always be powered within the specified range.
 2. Although not required by the Micron device, JEDEC specifies issuing another LMR command ($A8 = 0$) prior to activating any bank. If another LMR command is issued, the same, previously issued operating parameters must be used.
 3. The two AUTO REFRESH commands at T_{d0} and T_{e0} may be applied following the LMR command at T_{a0} .
 4. t_{MRD} is required before any command can be applied (during MRD time only NOPs or DESELECTs are allowed), and 200 cycles of CK are required before a READ command can be issued.
 5. While programming the operating parameters, reset the DLL with $A8 = 1$.

REGISTER DEFINITION

Mode Register

The mode register is used to define the specific DDR SDRAM mode of operation. This definition includes the selection of a burst length, a burst type, a CAS latency, and an operating mode, as shown in Figure 23. The mode register is programmed via the LMR command (with BA0 = 0 and BA1 = 0) and will retain the stored information until it is programmed again or until the device loses power (except for bit A8, which is self-clearing).

Reprogramming the mode register will not alter the contents of the memory, provided it is performed correctly. The mode register must be loaded (reloaded) when all banks are idle and no bursts are in progress, and the controller must wait the specified time before initiating the subsequent operation. Violating either of these requirements will result in unspecified operation.

Mode register bits A0–A2 specify the burst length, A3 specifies the type of burst (sequential or interleaved), A4–A6 specify the CAS latency, and A7–An specify the operating mode.

Figure 23: Mode Register Definition

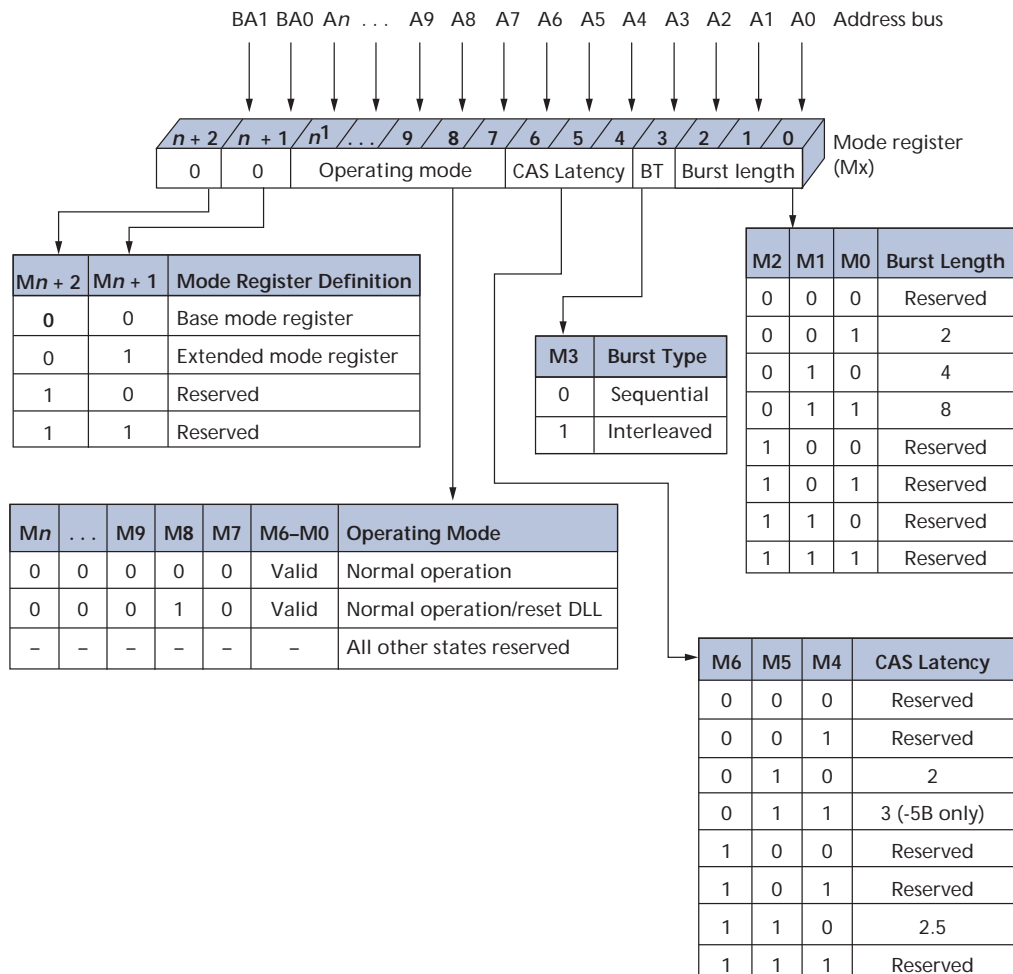

Notes: 1. n is the most significant row address bit from Table 2 on page 2.

Burst Length (BL)

Read and write accesses to the DDR SDRAM are burst oriented, with the burst length being programmable for both READ and WRITE bursts, as shown in Figure 23 on page 55. The burst length determines the maximum number of column locations that can be accessed for a given READ or WRITE command. BL = 2, BL = 4, or BL = 8 locations are available for both the sequential and the interleaved burst types. Reserved states should not be used, as unknown operation or incompatibility with future versions may result.

When a READ or WRITE command is issued, a block of columns equal to the burst length is effectively selected. All accesses for that burst take place within this block—meaning that the burst will wrap within the block if a boundary is reached. The block is uniquely selected by A1–Ai when BL = 2, by A2–Ai when BL = 4, and by A3–Ai when BL = 8 (where Ai is the most significant column address bit for a given configuration). The remaining (least significant) address bit(s) is (are) used to select the starting location within the block. For example: for BL = 8, A3–Ai select the eight-data-element block; A0–A2 select the first access within the block.

Burst Type

Accesses within a given burst may be programmed to be either sequential or interleaved; this is referred to as the burst type and is selected via bit M3.

The ordering of accesses within a burst is determined by the burst length, the burst type, and the starting column address, as shown in Table 34.

Table 34: Burst Definition

Burst Length	Starting Column Address			Order of Accesses Within a Burst	
				Type = Sequential	Type = Interleaved
2	–	–	A0	–	–
	–	–	0	0-1	0-1
	–	–	1	1-0	1-0
4	–	A1	A0	–	–
	–	0	0	0-1-2-3	0-1-2-3
	–	0	1	1-2-3-0	1-0-3-2
	–	1	0	2-3-0-1	2-3-0-1
	–	1	1	3-0-1-2	3-2-1-0
8	A2	A1	A0	–	–
	0	0	0	0-1-2-3-4-5-6-7	0-1-2-3-4-5-6-7
	0	0	1	1-2-3-4-5-6-7-0	1-0-3-2-5-4-7-6
	0	1	0	2-3-4-5-6-7-0-1	2-3-0-1-6-7-4-5
	0	1	1	3-4-5-6-7-0-1-2	3-2-1-0-7-6-5-4
	1	0	0	4-5-6-7-0-1-2-3	4-5-6-7-0-1-2-3
	1	0	1	5-6-7-0-1-2-3-4	5-4-7-6-1-0-3-2
	1	1	0	6-7-0-1-2-3-4-5	6-7-4-5-2-3-0-1
	1	1	1	7-0-1-2-3-4-5-6	7-6-5-4-3-2-1-0

CAS Latency (CL)

The CL is the delay, in clock cycles, between the registration of a READ command and the availability of the first bit of output data. The latency can be set to 2, 2.5, or 3 (-5B only) clocks, as shown in Figure 24. Reserved states should not be used, as unknown operation or incompatibility with future versions may result.

If a READ command is registered at clock edge n , and the latency is m clocks, the data will be available nominally coincident with clock edge $n + m$. Table 35 on page 58 indicates the operating frequencies at which each CL setting can be used.

Figure 24: CAS Latency

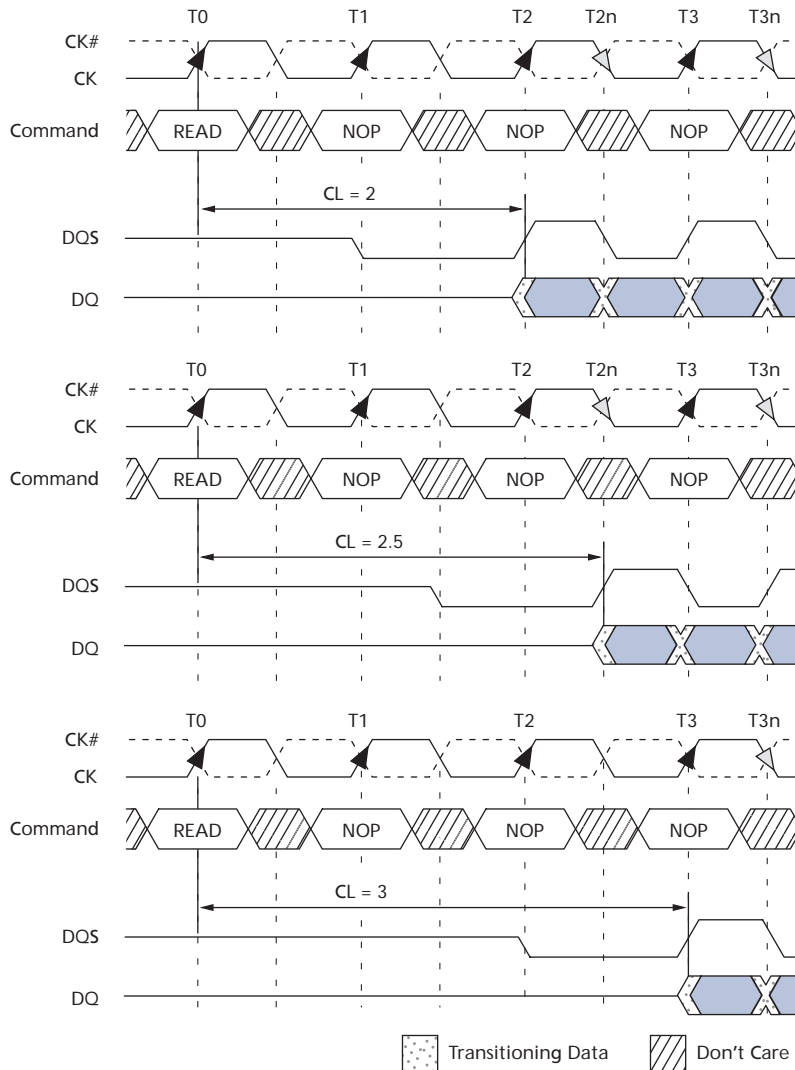

Note: BL = 4 in the cases shown; shown with nominal t_{AC} , t_{DQSK} , and t_{DQSQ} .

Table 35: CAS Latency

Speed	Allowable Operating Clock Frequency (MHz)		
	CL = 2	CL = 2.5	CL = 3
-5B	$75 \leq f \leq 133$	$75 \leq f \leq 167$	$133 \leq f \leq 200$
-6/-6T	$75 \leq f \leq 133$	$75 \leq f \leq 167$	-
-75E	$75 \leq f \leq 133$	$75 \leq f \leq 133$	-
-75Z	$75 \leq f \leq 133$	$75 \leq f \leq 133$	-
-75	$75 \leq f \leq 100$	$75 \leq f \leq 133$	-

Operating Mode

The normal operating mode is selected by issuing an LMR command with bits A7–An each set to zero and bits A0–A6 set to the desired values. A DLL reset is initiated by issuing an LMR command with bits A7 and A9–An each set to zero, bit A8 set to one, and bits A0–A6 set to the desired values. Although not required by the Micron device, JEDEC specifications recommend that an LMR command resetting the DLL should always be followed by an LMR command selecting normal operating mode.

All other combinations of values for A7–An are reserved for future use and/or test modes. Test modes and reserved states should not be used, as unknown operation or incompatibility with future versions may result.

Extended Mode Register

The extended mode register controls functions beyond those controlled by the mode register; these additional functions are DLL enable/disable and output drive strength. These functions are controlled via the bits shown in Figure 25 on page 59. The extended mode register is programmed via the LMR command to the mode register (with BA0 = 1 and BA1 = 0) and will retain the stored information until it is programmed again or until the device loses power. The enabling of the DLL should always be followed by an LMR command to the mode register (BA0/BA1 = 0) to reset the DLL. The extended mode register must be loaded when all banks are idle and no bursts are in progress, and the controller must wait the specified time before initiating any subsequent operation. Violating either requirement could result in an unspecified operation.

Output Drive Strength

The normal drive strength for all outputs is specified to be SSTL_2, Class II. This option is intended for the support of the lighter load and/or point-to-point environments. The selection of the reduced drive strength will alter the DQ and DQS pins from SSTL_2, Class II drive strength to a reduced drive strength, which is approximately 54% of the SSTL_2, Class II drive strength.

DLL Enable/Disable

When the part is running without the DLL enabled, device functionality may be altered. The DLL must be enabled for normal operation. DLL enable is required during power-up initialization and upon returning to normal operation after having disabled the DLL for the purpose of debug or evaluation (when the device exits self refresh mode, the DLL is enabled automatically). Anytime the DLL is enabled, 200 clock cycles with CKE HIGH must occur before a READ command can be issued.

Figure 25: Extended Mode Register Definition

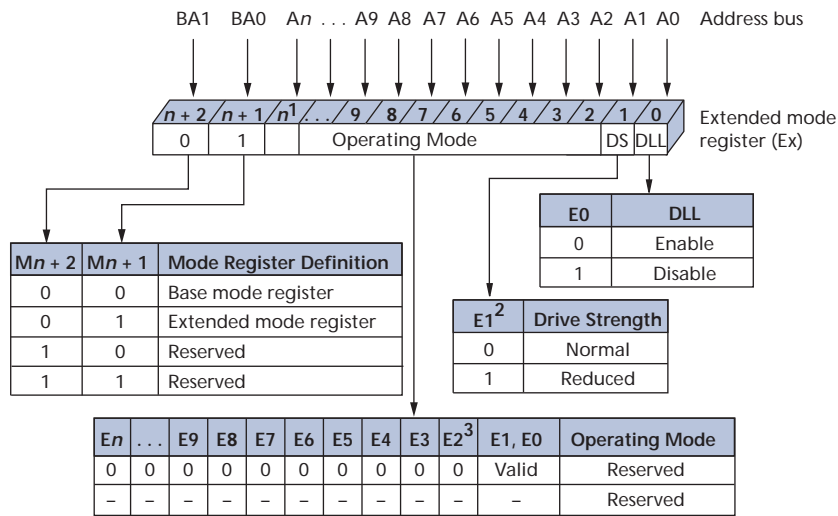

- Notes:
1. n is the most significant row address bit from Table 2 on page 2.
 2. The QFC# option is not supported.

ACTIVE

After a row is opened with an ACTIVE command, a READ or WRITE command may be issued to that row, subject to the t_{RCD} specification. $t_{RCD}(\text{MIN})$ should be divided by the clock period and rounded up to the next whole number to determine the earliest clock edge after the ACTIVE command on which a READ or WRITE command can be entered. For example, a t_{RCD} specification of 20ns with a 133 MHz clock (7.5ns period) results in 2.7 clocks rounded to 3. This is reflected in Figure 26 on page 60, which covers any case where $2 < t_{RCD}(\text{MIN})/t_{CK} \leq 3$ (Figure 26 also shows the same case for t_{RRD} ; the same procedure is used to convert other specification limits from time units to clock cycles).

A row remains active (or open) for accesses until a PRECHARGE command is issued to that bank. A PRECHARGE command must be issued before opening a different row in the same bank.

A subsequent ACTIVE command to a different row in the same bank can only be issued after the previous active row has been “closed” (precharged). The minimum time interval between successive ACTIVE commands to the same bank is defined by t_{RC} .

A subsequent ACTIVE command to another bank can be issued while the first bank is being accessed, which results in a reduction of total row-access overhead. The minimum time interval between successive ACTIVE commands to different banks is defined by t_{RRD} .

Figure 26: Example: Meeting t_{RCD} (t_{RRD}) MIN When $2 < t_{RCD}$ (t_{RRD}) MIN/ $t_{CK} \leq 3$

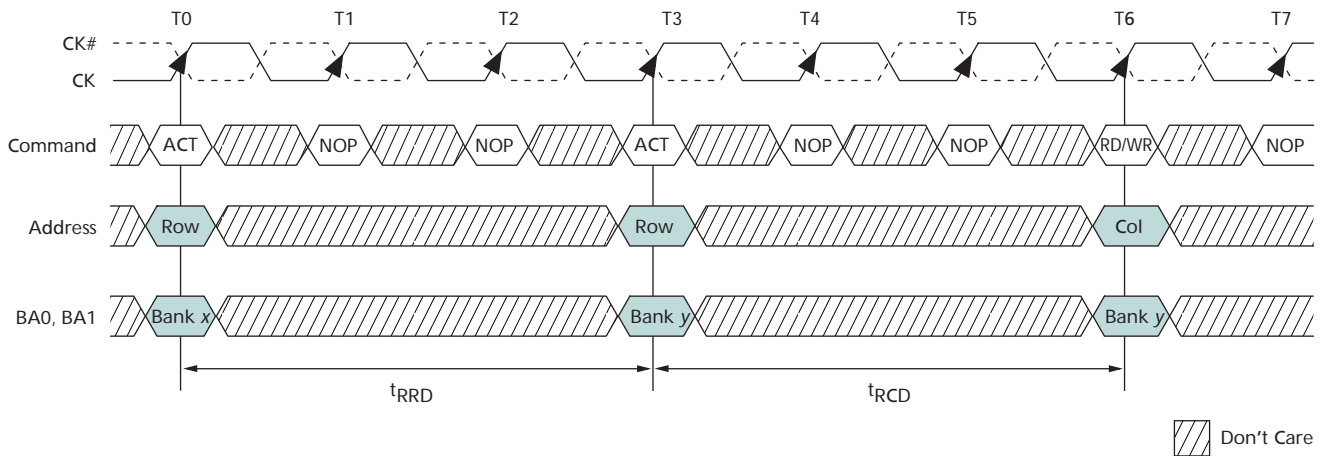

READ

During the READ command, the value on input A10 determines whether or not auto precharge is used. If auto precharge is selected, the row being accessed will be precharged at the end of the READ burst; if auto precharge is not selected, the row will remain open for subsequent accesses.

Note: For the READ commands used in the following illustrations, auto precharge is disabled.

During READ bursts, the valid data-out element from the starting column address will be available following the CL after the READ command. Each subsequent data-out element will be valid nominally at the next positive or negative clock edge (that is, at the next crossing of CK and CK#). Figure 27 on page 62 shows the general timing for each possible CL setting. DQS is driven by the DDR SDRAM along with output data. The initial LOW state on DQS is known as the read preamble; the LOW state coincident with the last data-out element is known as the read postamble.

Upon completion of a burst, assuming no other commands have been initiated, the DQ will go High-Z. Detailed explanations of t_{DQSQ} (valid data-out skew), t_{QH} (data-out window hold), and the valid data window are depicted in Figure 35 on page 70 and Figure 36 on page 71. Detailed explanations of t_{DQSCK} (DQS transition skew to CK) and t_{AC} (data-out transition skew to CK) are depicted in Figure 37 on page 72.

Data from any READ burst may be concatenated or truncated with data from a subsequent READ command. In either case, a continuous flow of data can be maintained. The first data element from the new burst follows either the last element of a completed burst or the last desired data element of a longer burst which is being truncated. The new READ command should be issued x cycles after the first READ command, where x equals the number of desired data element pairs (pairs are required by the $2n$ -prefetch architecture). This is shown in Figure 28 on page 63. A READ command can be initiated on any clock cycle following a previous READ command. Nonconsecutive read data is illustrated in Figure 29 on page 64. Full-speed random read accesses within a page (or pages) can be performed, as shown in Figure 30 on page 65.

Data from any READ burst may be truncated with a BURST TERMINATE command, as shown in Figure 31 on page 66. The BURST TERMINATE latency is equal to the CL, that is, the BURST TERMINATE command should be issued x cycles after the READ command where x equals the number of desired data element pairs (pairs are required by the $2n$ -prefetch architecture).

Data from any READ burst must be completed or truncated before a subsequent WRITE command can be issued. If truncation is necessary, the BURST TERMINATE command must be used, as shown in Figure 32 on page 67. The t_{DQSS} (NOM) case is shown; the t_{DQSS} (MAX) case has a longer bus idle time. (t_{DQSS} [MIN] and t_{DQSS} [MAX] are defined in the section on WRITES.) A READ burst may be followed by, or truncated with, a PRECHARGE command to the same bank provided that auto precharge was not activated.

The PRECHARGE command should be issued x cycles after the READ command, where x equals the number of desired data element pairs (pairs are required by the $2n$ -prefetch architecture). This is shown in Figure 33 on page 68. Following the PRECHARGE command, a subsequent command to the same bank cannot be issued until both t_{RAS} and t_{RP} have been met. Part of the row precharge time is hidden during the access of the last data elements.

Figure 27: READ Burst

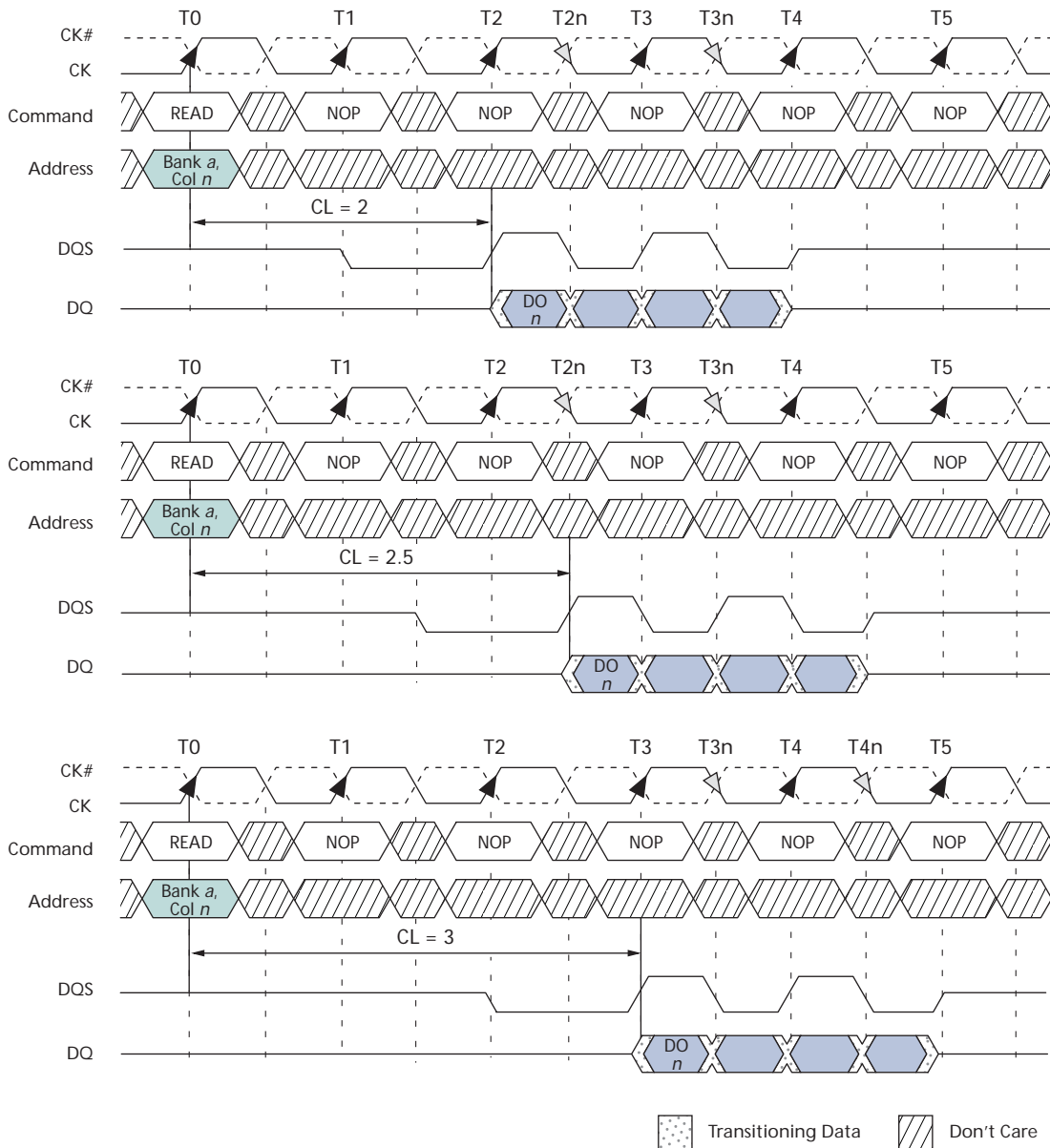

- Notes:
1. DO n = data-out from column n .
 2. BL = 4.
 3. Three subsequent elements of data-out appear in the programmed order following DO n .
 4. Shown with nominal t_{AC} , t_{DQSK} , and t_{DQSQ} .

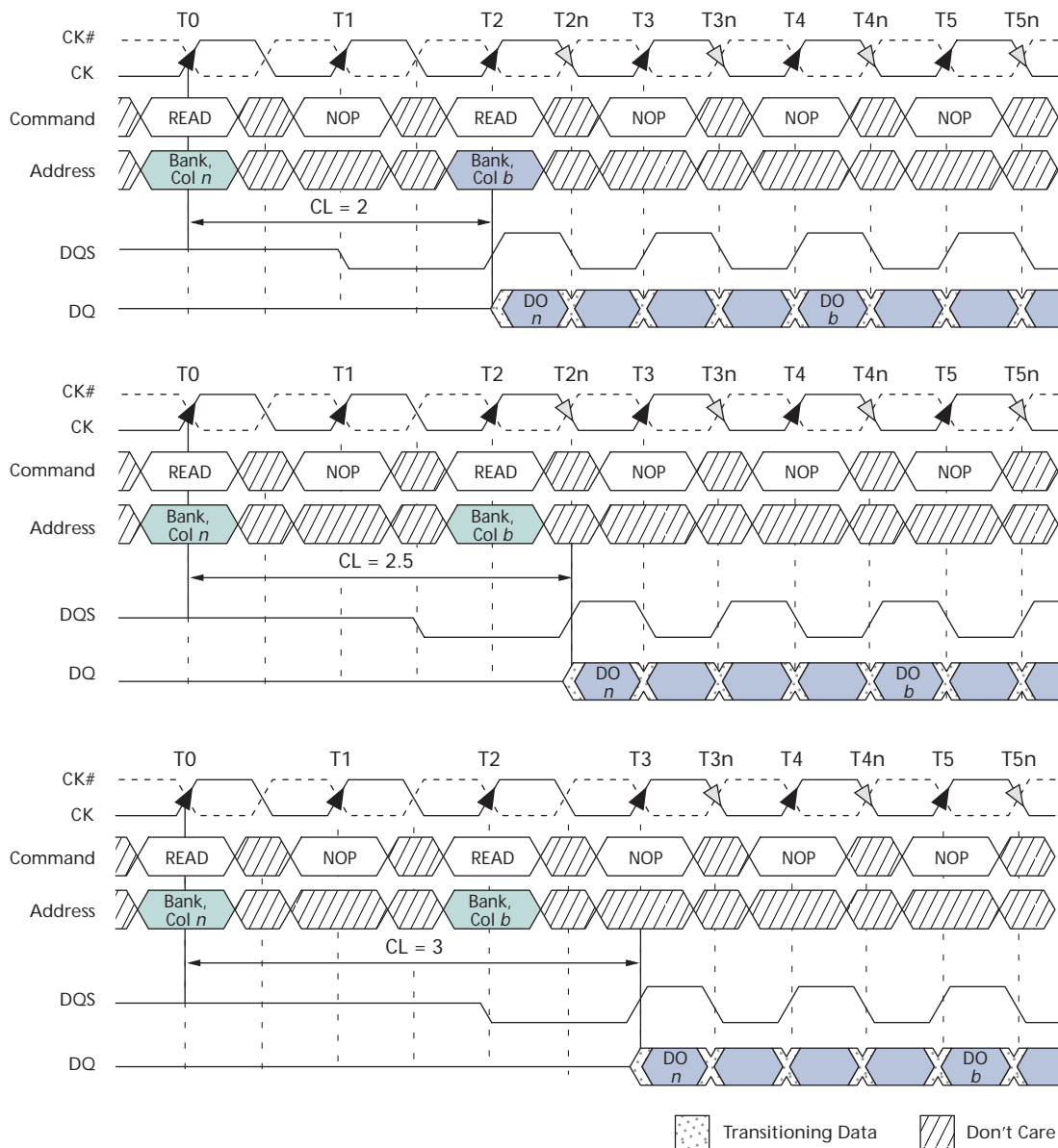
Figure 28: Consecutive READ Bursts

- Notes:
1. DO *n* (or *b*) = data-out from column *n* (or column *b*).
 2. BL = 4 or BL = 8 (if BL = 4, the bursts are concatenated; if BL = 8, the second burst interrupts the first).
 3. Three subsequent elements of data-out appear in the programmed order following DO *n*.
 4. Three (or seven) subsequent elements of data-out appear in the programmed order following DO *b*.
 5. Shown with nominal ^tAC, ^tDQSCK, and ^tDQSQ.
 6. Example applies only when READ commands are issued to same device.

Figure 29: Nonconsecutive READ Bursts

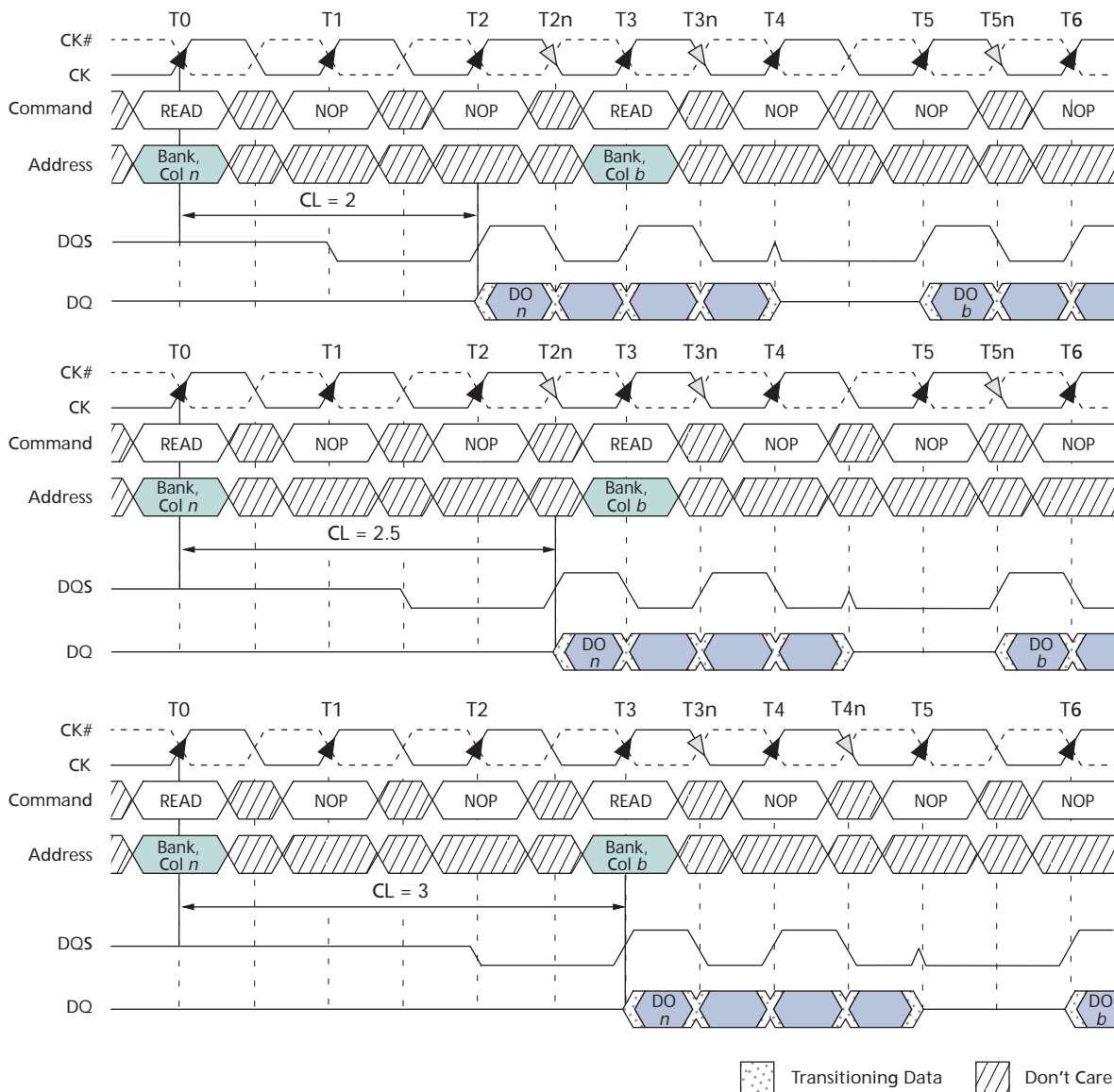

- Notes:
1. DO *n* (or *b*) = data-out from column *n* (or column *b*).
 2. BL = 4 or BL = 8 (if BL = 4, the bursts are concatenated; if BL = 8, the second burst interrupts the first).
 3. Three subsequent elements of data-out appear in the programmed order following DO *n*.
 4. Three (or seven) subsequent elements of data-out appear in the programmed order following DO *b*.
 5. Shown with nominal t_{AC} , t_{DQSCK} , and t_{DQSQ} .

Figure 30: Random READ Accesses

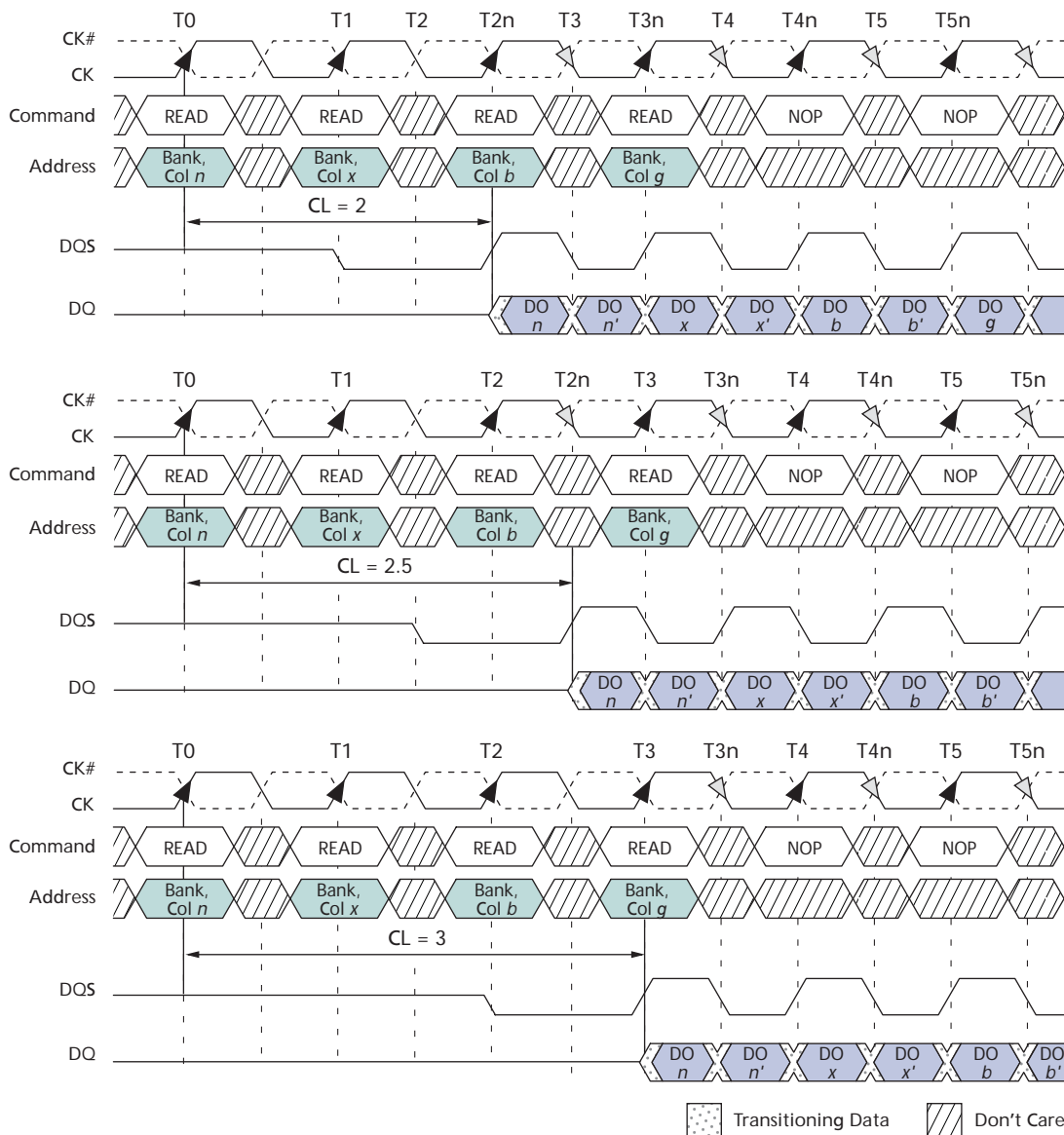

- Notes:
1. DO n (or x or b or g) = data-out from column n (or column x or column b or column g).
 2. BL = 2, BL = 4, or BL = 8 (if BL = 4 or BL = 8, the following burst interrupts the previous).
 3. n' , x' , b' , or g' indicate the next data-out following DO n , DO x , DO b , or DO g , respectively.
 4. READs are to an active row in any bank.
 5. Shown with nominal t_{AC} , t_{DQSC} , and t_{DQSQ} .

Figure 31: Terminating a READ Burst

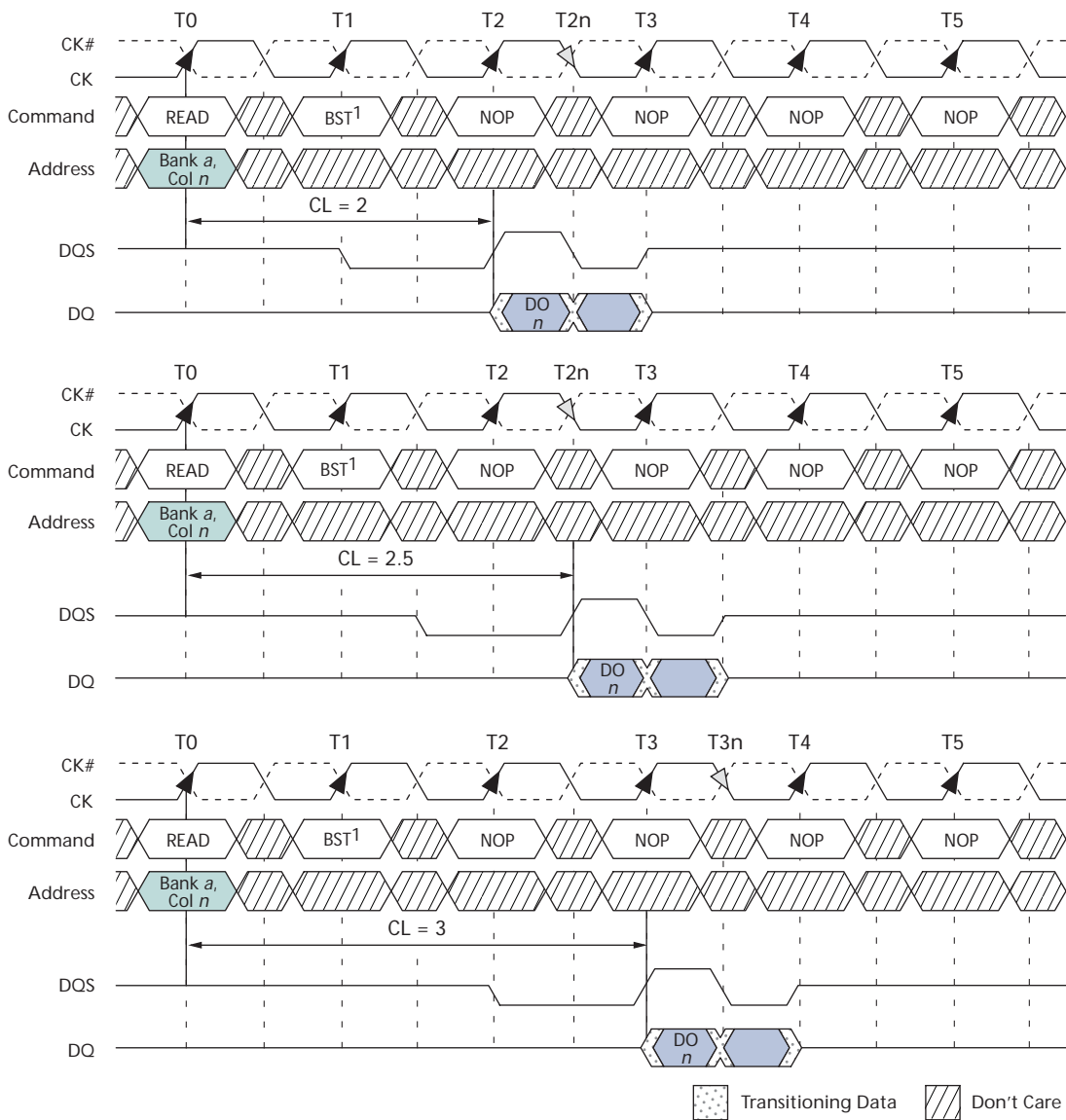

- Notes:
1. Page remains open.
 2. DO *n* = data-out from column *n*.
 3. BL = 4.
 4. Subsequent element of data-out appears in the programmed order following DO *n*.
 5. Shown with nominal ^tAC, ^tDQSCK, and ^tDQSQ.

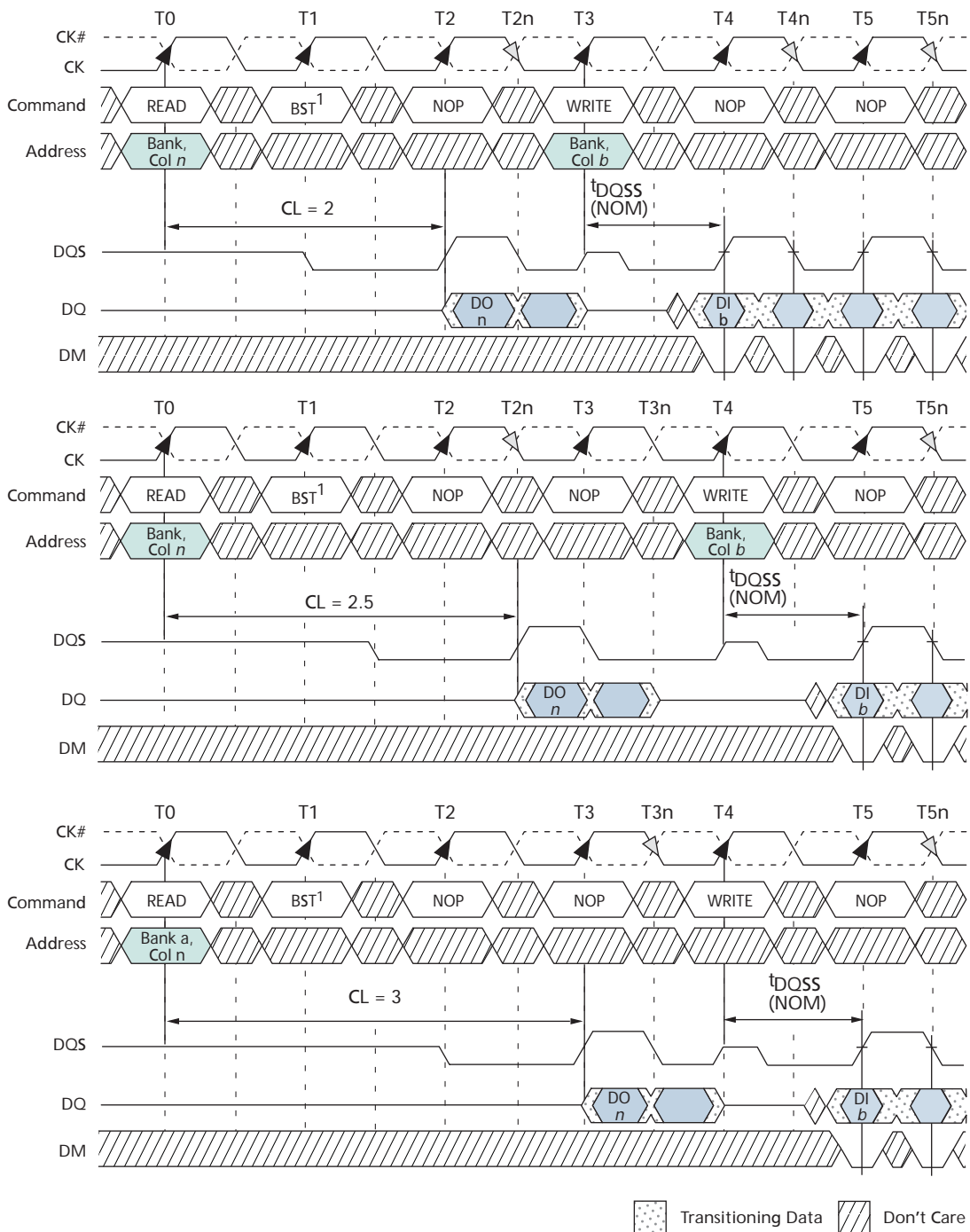
Figure 32: READ-to-WRITE

- Notes:
1. Page remains open.
 2. DO *n* = data-out from column *n*; DI *b* = data-in from column *b*.
 3. BL = 4 (applies for bursts of 8 as well; if BL = 2, the BURST command shown can be NOP).
 4. One subsequent element of data-out appears in the programmed order following DO *n*.
 5. Data-in elements are applied following DI *b* in the programmed order.
 6. Shown with nominal t_{AC}, t_{DQSK}, and t_{DQSQ}.

Figure 33: READ-to-PRECHARGE

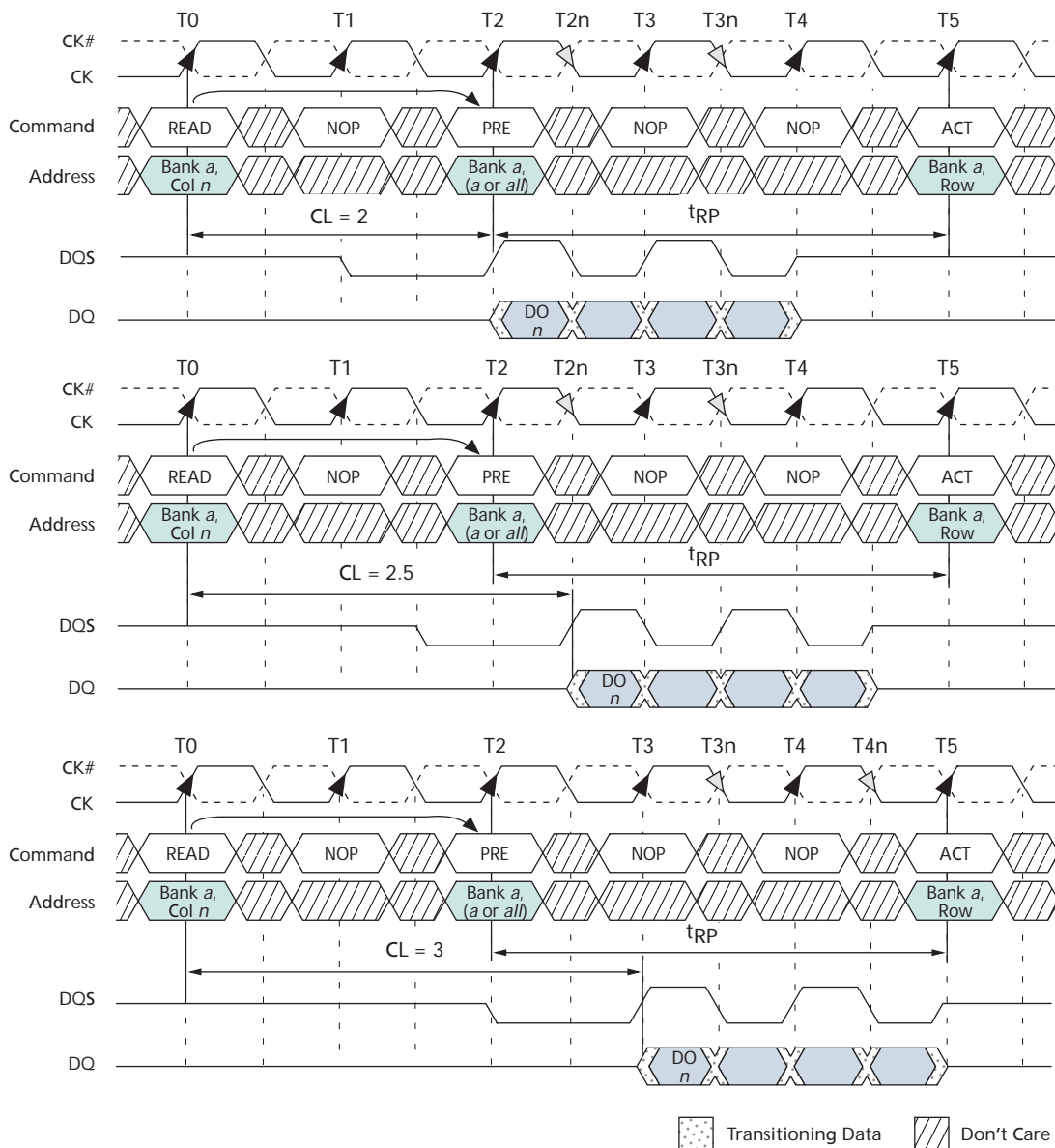

- Notes:
1. Provided t^1_{RAS} (MIN) is met, a READ command with auto precharge enabled would cause a precharge to be performed at x number of clock cycles after the READ command, where $x = BL/2$.
 2. DO_n = data-out from column n .
 3. $BL = 4$ or an interrupted burst of 8.
 4. Three subsequent elements of data-out appear in the programmed order following DO_n .
 5. Shown with nominal t^1_{AC} , t^1_{DQSCk} , and t^1_{DQSQ} .
 6. READ-to-PRECHARGE equals two clocks, which allows two data pairs of data-out; it is also assumed that t^1_{RAS} (MIN) is met.
 7. An ACTIVE command to the same bank is only allowed if t^1_{RC} (MIN) is met.

Figure 34: Bank READ – Without Auto Precharge

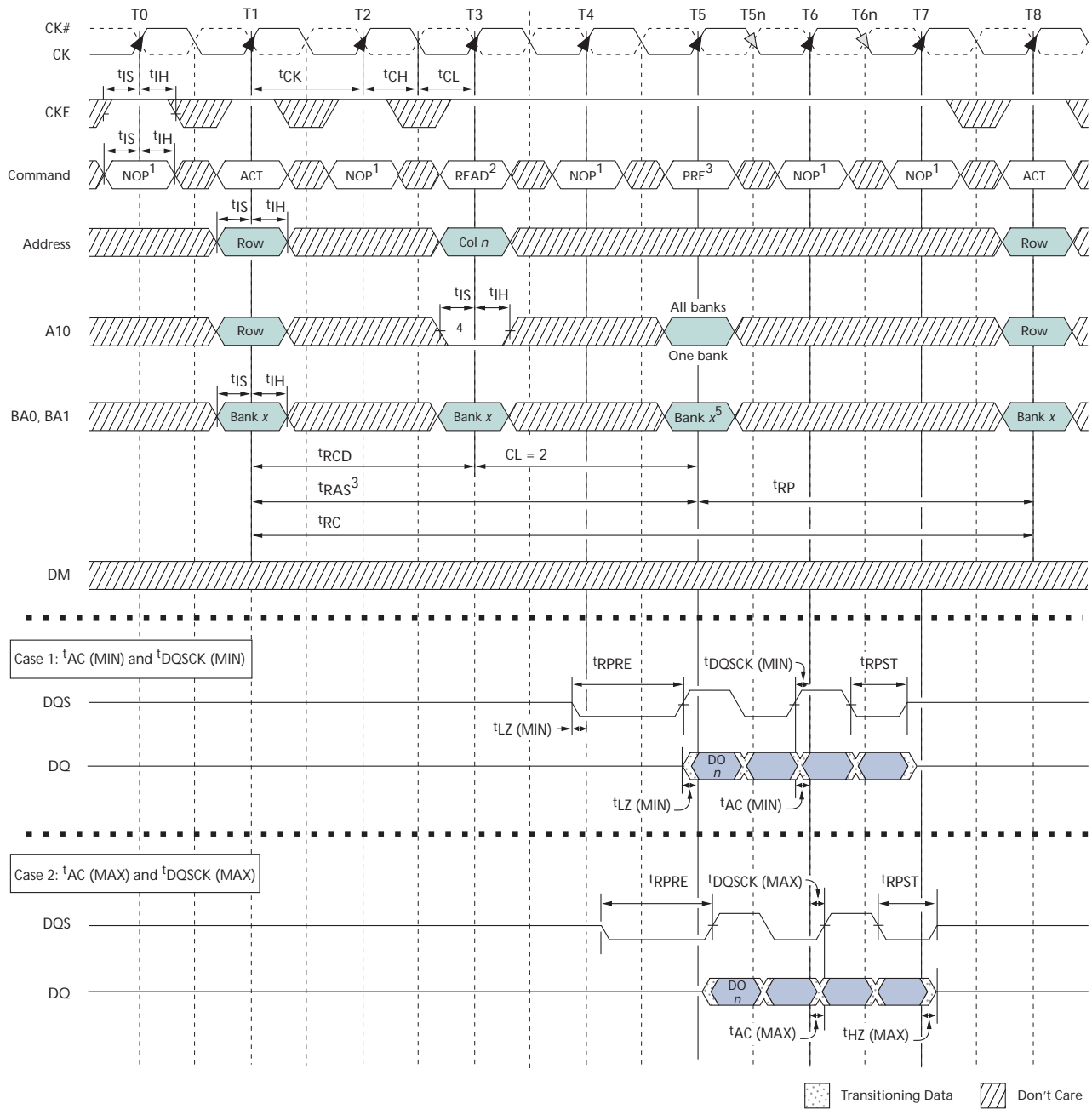

- Notes:
1. NOP commands are shown for ease of illustration; other commands may be valid at these times.
 2. BL = 4.
 3. The PRECHARGE command can only be applied at T5 if $t_{RAS}^{(MIN)}$ is met.
 4. Disable auto precharge.
 5. "Don't Care" if A10 is HIGH at T5.
 6. DO n (or b) = data-out from column n (or column b); subsequent elements are provided in the programmed order.
 7. Refer to Figure 35 on page 70, Figure 36 on page 71, and Figure 37 on page 72 for detailed DQS and DQ timing.

Figure 35: x4, x8 Data Output Timing – t_{DQSQ} , t_{QH} , and Data Valid Window

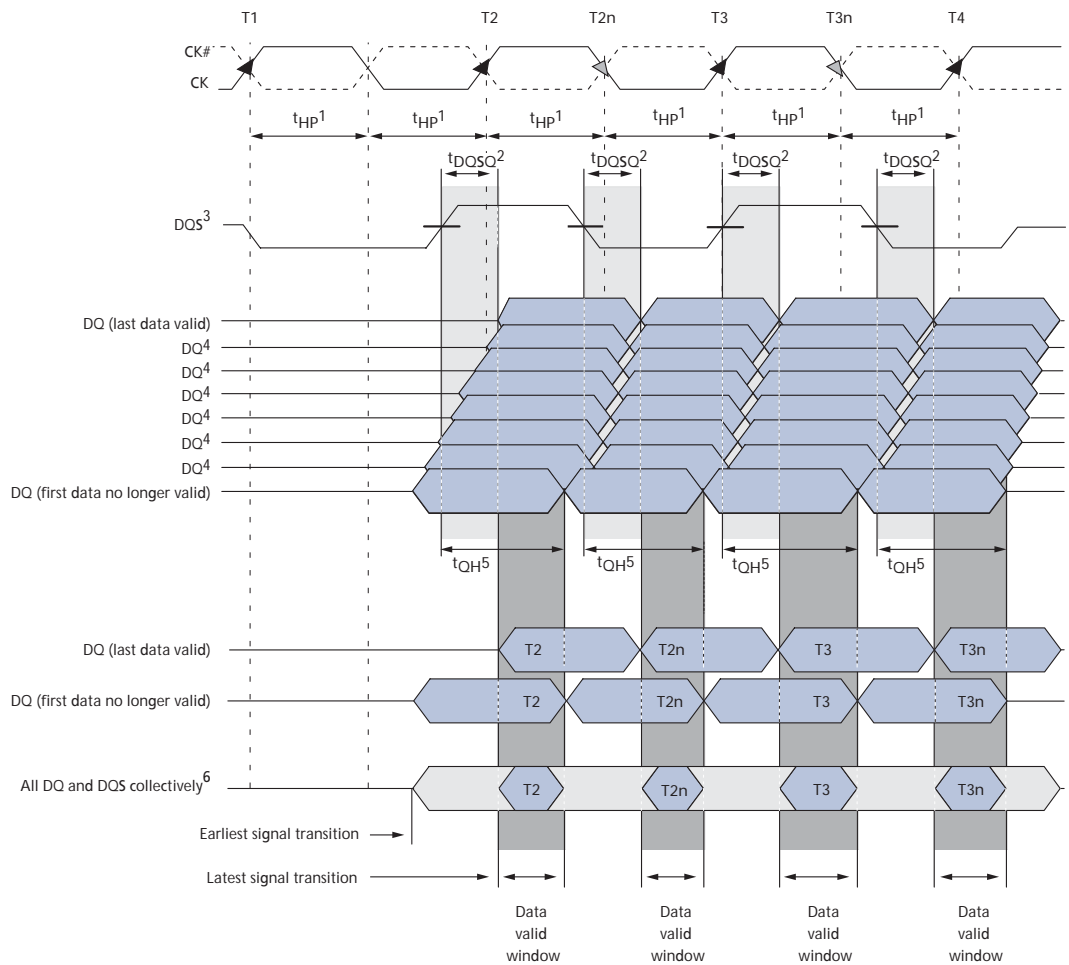

- Notes:
1. t_{HP} is the lesser of t_{CL} or t_{CH} clock transition collectively when a bank is active.
 2. t_{DQSQ} is derived at each DQS clock edge, is not cumulative over time, begins with DQS transition, and ends with the last valid DQ transition.
 3. DQ transitioning after DQS transition define the t_{DQSQ} window. DQS transitions at T2 and T2n are an "early DQS"; at T3, a "nominal DQS"; and at T3n, a "late DQS".
 4. For a x4, only two DQ apply.
 5. t_{QH} is derived from t_{HP} : $t_{QH} = t_{HP} - t_{QHS}$.
 6. The data valid window is derived for each DQS transitions and is defined as $t_{QH} - t_{DQSQ}$.

Figure 36: x16 Data Output Timing – t_{DQSQ} , t_{QH} , and Data Valid Window

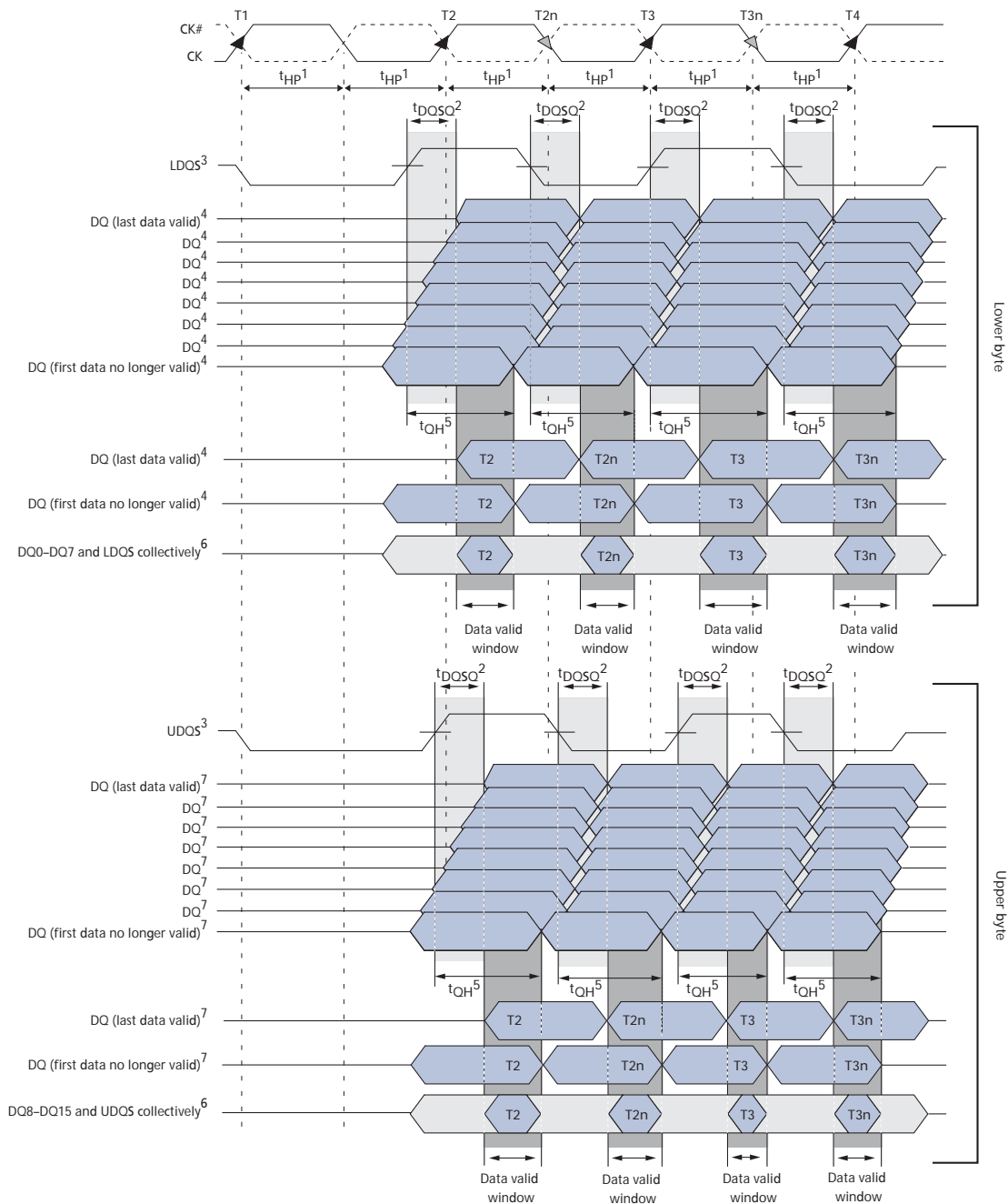

- Notes:
- t_{HP} is the lesser of t_{CL} or t_{CH} clock transition collectively when a bank is active.
 - t_{DQSQ} is derived at each DQS clock edge, is not cumulative over time, begins with DQS transition, and ends with the last valid DQ transition.
 - DQ transitioning after DQS transition define the t_{DQSQ} window. LDQS defines the lower byte, and UDQS defines the upper byte.
 - DQ0, DQ1, DQ2, DQ3, DQ4, DQ5, DQ6, or DQ7.
 - t_{QH} is derived from t_{HP} : $t_{QH} = t_{HP} - t_{QHS}$.
 - The data valid window is derived for each DQS transition and is $t_{QH} - t_{DQSQ}$.
 - DQ8, DQ9, DQ10, DQ11, DQ12, DQ13, DQ14, or DQ15.

Figure 37: Data Output Timing – t_{AC} and t_{DQSK}

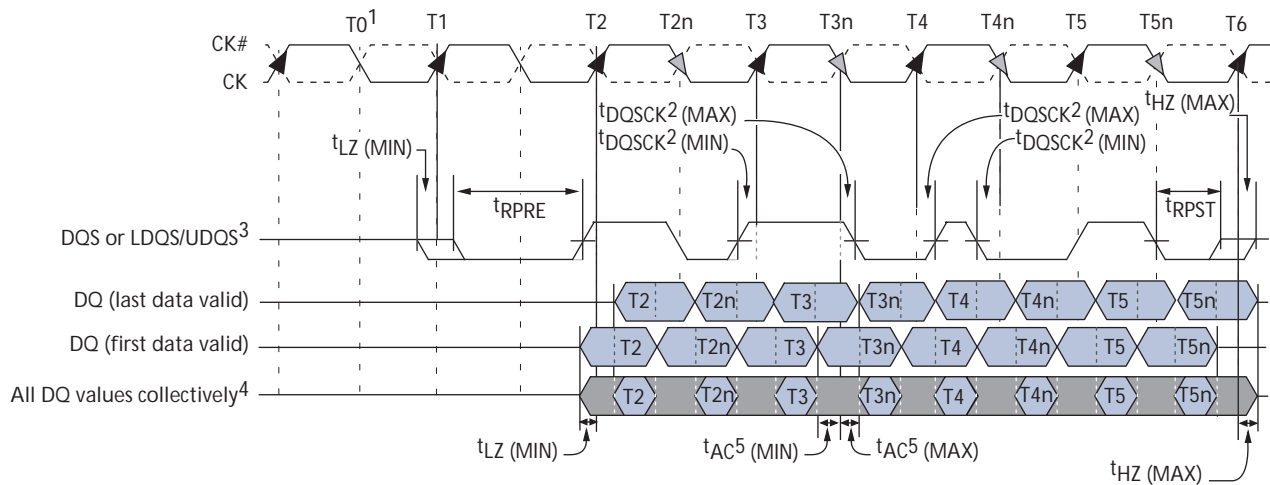

- Notes:
1. READ command with CL = 2 issued at T0.
 2. t_{DQSK} is the DQS output window relative to CK and is the “long term” component of the DQS skew.
 3. DQ transitioning after DQS transition define the t_{DQSQ} window.
 4. All DQ must transition by t_{DQSQ} after DQS transitions, regardless of t_{AC} .
 5. t_{AC} is the DQ output window relative to CK and is the “long term” component of DQ skew.
 6. $t_{LZ} (MIN)$ and $t_{AC} (MIN)$ are the first valid signal transitions.
 7. $t_{HZ} (MAX)$ and $t_{AC} (MAX)$ are the latest valid signal transitions.

WRITE

During a WRITE command, the value on input A10 determines whether or not auto precharge is used. If auto precharge is selected, the row being accessed will be precharged at the end of the WRITE burst (after t_{WR} time); if auto precharge is not selected, the row will remain open for subsequent accesses.

Input data appearing on the DQ is written to the memory array subject to the DM input logic level appearing coincident with the data. If a given DM signal is registered LOW, the corresponding data will be written to memory. If the DM signal is registered HIGH, the corresponding data inputs will be ignored, and a WRITE will not be executed to that byte/column location.

Note: For the WRITE commands used in the following illustrations, auto precharge is disabled.

During WRITE bursts, the first valid data-in element will be registered on the first rising edge of DQS following the WRITE command, and subsequent data elements will be registered on successive edges of DQS. The LOW state on DQS between the WRITE command and the first rising edge is known as the write preamble; the LOW state on DQS following the last data-in element is known as the write postamble.

The time between the WRITE command and the first corresponding rising edge of DQS (t_{DQSS}) is specified with a relatively wide range (from 75% to 125% of one clock cycle). All of the WRITE diagrams show the nominal case, and where the two extreme cases (that is, $t_{DQSS} [MIN]$ and $t_{DQSS} [MAX]$) might not be intuitive; they have also been included. Figure 38 on page 74 shows the nominal case and the extremes of t_{DQSS} for BL = 4. Upon completion of a burst, assuming no other commands have been initiated, the DQ will remain High-Z and any additional input data will be ignored.

Data for any WRITE burst may be concatenated with or truncated with a subsequent WRITE command. In either case, a continuous flow of input data can be maintained. The new WRITE command can be issued on any positive edge of clock following the previous WRITE command. The first data element from the new burst is applied after either the last element of a completed burst or the last desired data element of a longer burst which is being truncated. The new WRITE command should be issued x cycles after the first WRITE command, where x equals the number of desired data element pairs (pairs are required by the $2n$ -prefetch architecture).

Figure 39 on page 75 shows concatenated bursts of 4. An example of nonconsecutive WRITES is shown in Figure 40 on page 76. Full-speed random write accesses within a page or pages can be performed as shown in Figure 41 on page 76.

Data for any WRITE burst may be followed by a subsequent READ command. To follow a WRITE without truncating the WRITE burst, t^{WTR} should be met, as shown in Figure 42 on page 77.

Data for any WRITE burst may be truncated by a subsequent READ command, as shown in Figure 43 on page 78.

Note that only the data-in pairs that are registered prior to the t^{WTR} period are written to the internal array, and any subsequent data-in should be masked with DM, as shown in Figure 44 on page 79.

Data for any WRITE burst may be followed by a subsequent PRECHARGE command. To follow a WRITE without truncating the WRITE burst, t^{WR} should be met, as shown in Figure 45 on page 80.

Data for any WRITE burst may be truncated by a subsequent PRECHARGE command, as shown in Figure 46 on page 81 and Figure 47 on page 82. Only the data-in pairs registered prior to the t^{WR} period are written to the internal array; any subsequent data-in should be masked with DM, as shown in Figures 46 and 47. After the PRECHARGE command, a subsequent command to the same bank cannot be issued until t^{RP} is met.

Figure 38: WRITE Burst

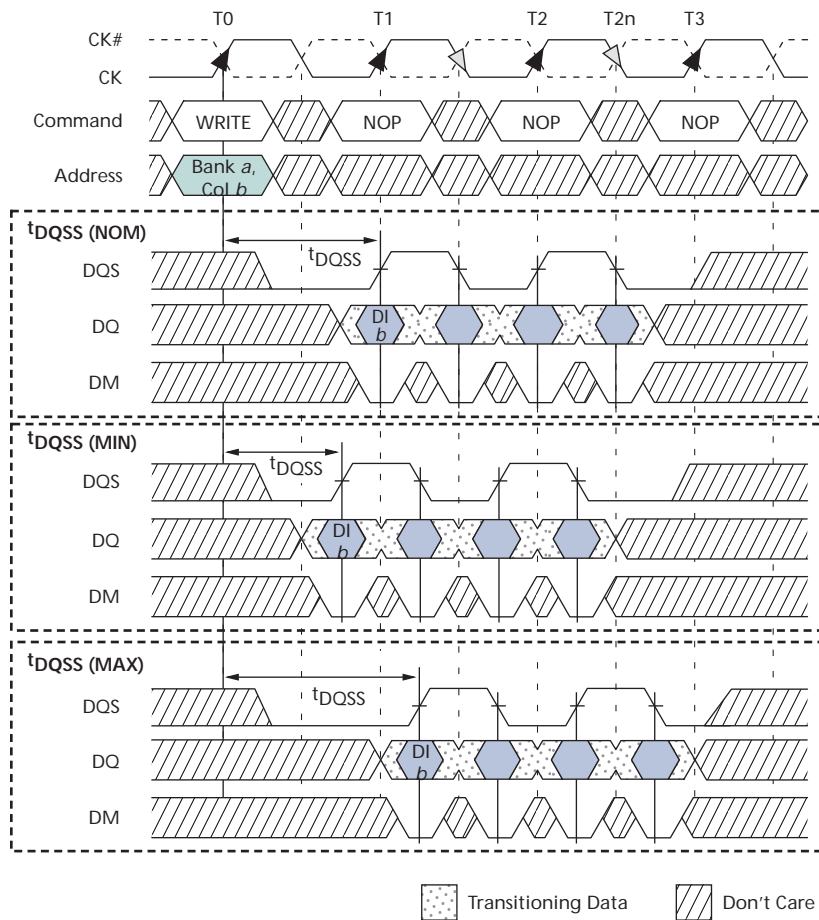

- Notes:
1. DI *b* = data-in for column *b*.
 2. Three subsequent elements of data-in are applied in the programmed order following DI *b*.
 3. An uninterrupted burst of 4 is shown.
 4. A10 is LOW with the WRITE command (auto precharge is disabled).

Figure 39: Consecutive WRITE-to-WRITE

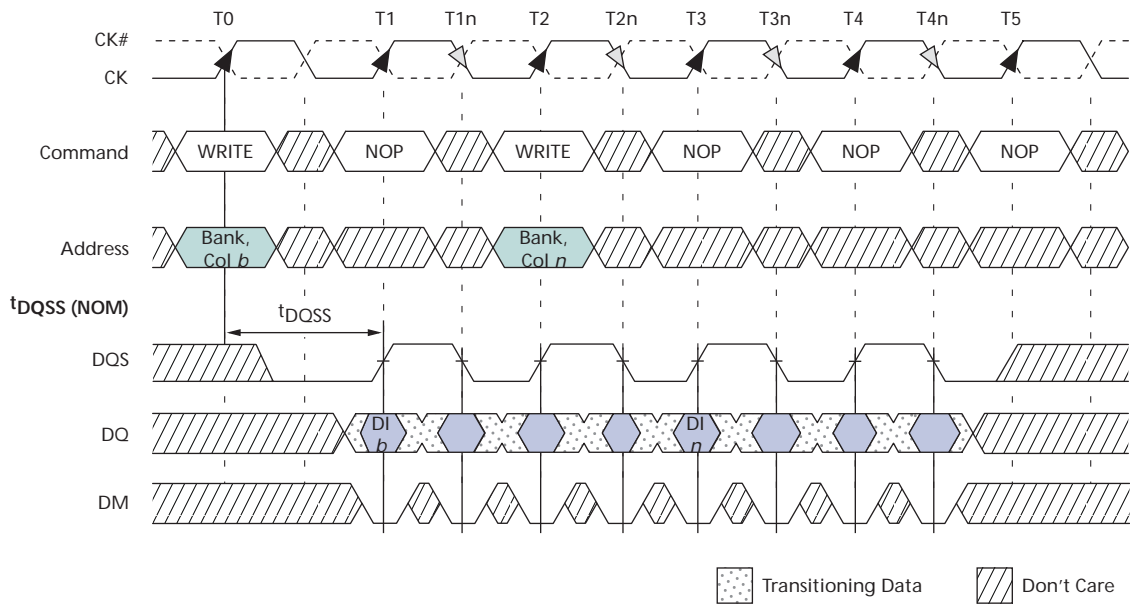

- Notes:
1. DI *b* (or *n*) = data-in from column *b* (or column *n*).
 2. Three subsequent elements of data-in are applied in the programmed order following DI *b*.
 3. Three subsequent elements of data-in are applied in the programmed order following DI *n*.
 4. An uninterrupted burst of 4 is shown.
 5. Each WRITE command may be to any bank.

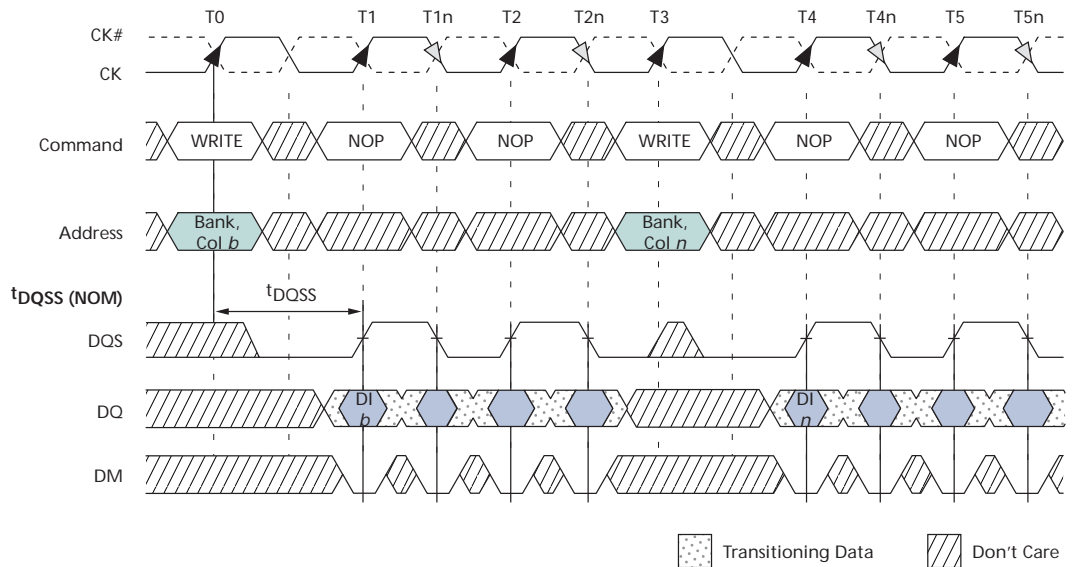
Figure 40: Nonconsecutive WRITE-to-WRITE

- Notes:
1. DI *b* (or *n*) = data-in from column *b* (or column *n*).
 2. Three subsequent elements of data-in are applied in the programmed order following DI *b*.
 3. Three subsequent elements of data-in are applied in the programmed order following DI *n*.
 4. An uninterrupted burst of 4 is shown.
 5. Each WRITE command may be to any bank.

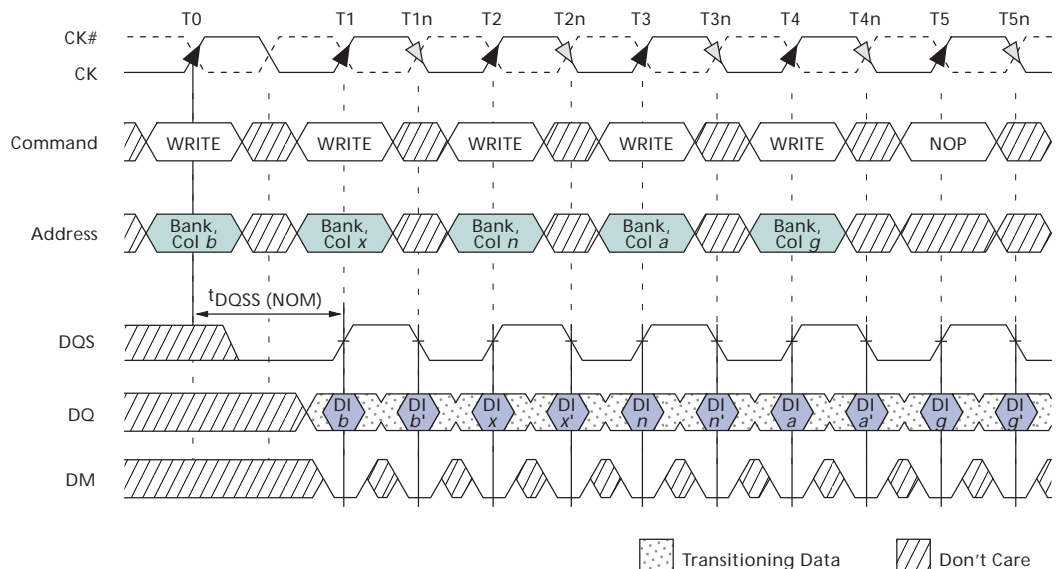
Figure 41: Random WRITE Cycles

- Notes:
1. DI *b* (or *x* or *n* or *a* or *g*) = data-in from column *b* (or column *x*, or column *n*, or column *a*, or column *g*).
 2. *b'*, *x'*, *n'*, *a'* or *g'* indicate the next data-in following DO *b*, DO *x*, DO *n*, DO *a*, or DO *g*, respectively.
 3. Programmed BL = 2, BL = 4, or BL = 8 in cases shown.
 4. Each WRITE command may be to any bank.

Figure 42: WRITE-to-READ – Uninterrupting

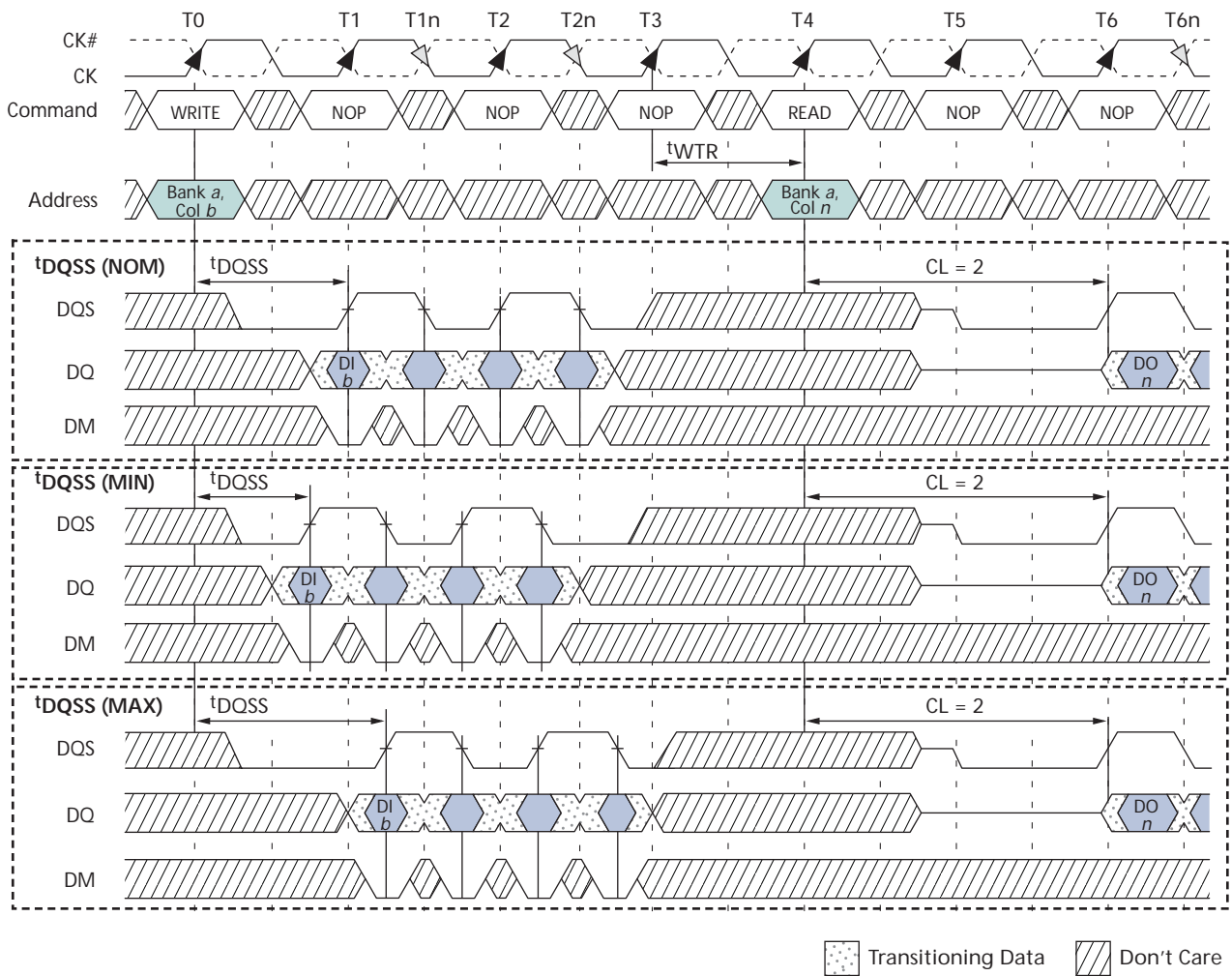

- Notes:
1. DI b = data-in for column b ; DO n = data-out for column n .
 2. Three subsequent elements of data-in are applied in the programmed order following DI b .
 3. An uninterrupted burst of 4 is shown.
 4. t_{WTR} is referenced from the first positive CK edge after the last data-in pair.
 5. The READ and WRITE commands are to the same device. However, the READ and WRITE commands may be to different devices, in which case t_{WTR} is not required, and the READ command could be applied earlier.
 6. A10 is LOW with the WRITE command (auto precharge is disabled).

Figure 43: WRITE-to-READ - Interrupting

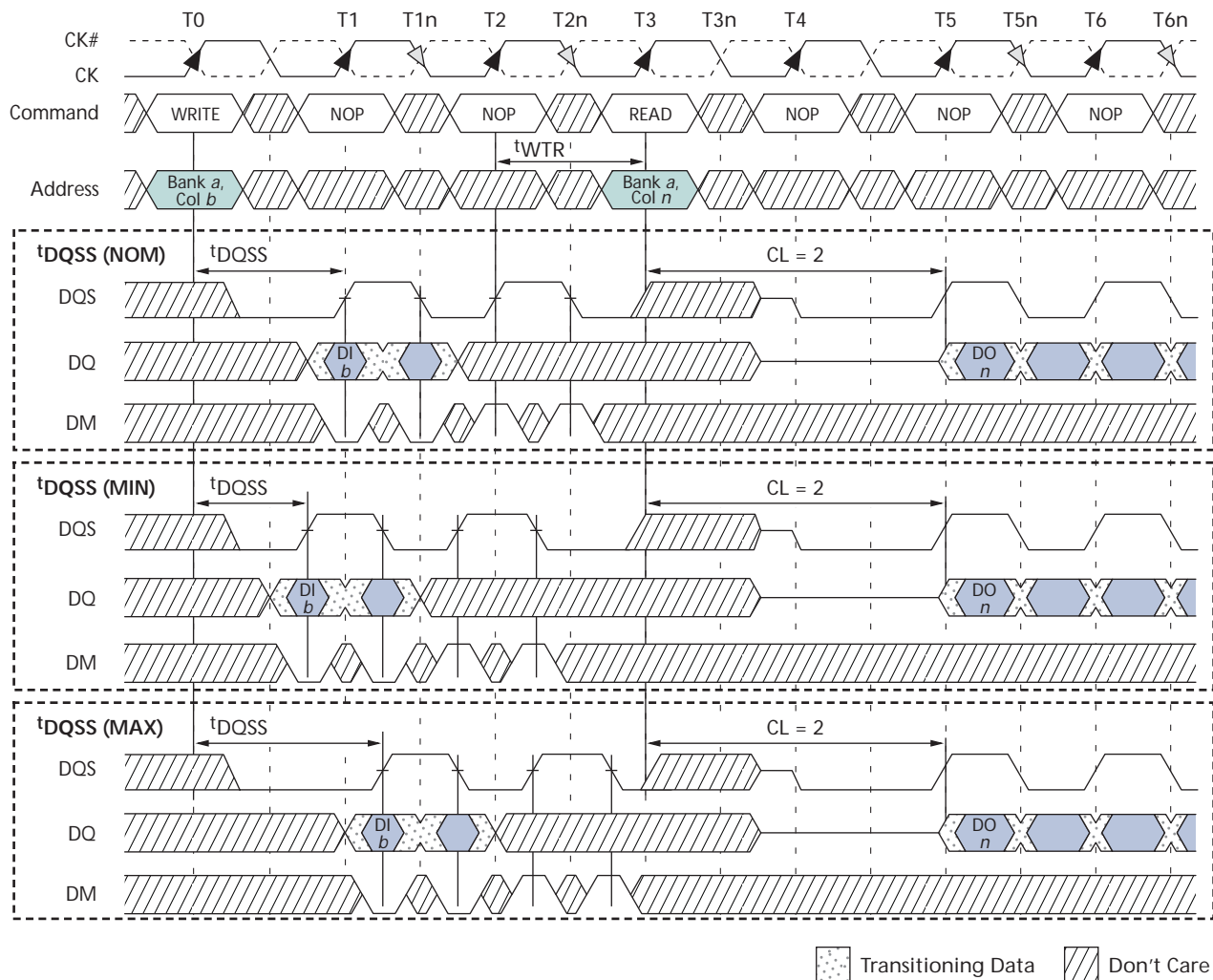

- Notes:
1. DI *b* = data-in for column *b*; DO *n* = data-out for column *n*.
 2. An interrupted burst of 4 is shown; two data elements are written.
 3. One subsequent element of data-in is applied in the programmed order following DI *b*.
 4. t_{WTR} is referenced from the first positive CK edge after the last data-in pair.
 5. A10 is LOW with the WRITE command (auto precharge is disabled).
 6. DQS is required at T2 and T2n (nominal case) to register DM.
 7. If the burst of 8 is used, DM and DQS are required at T3 and T3n because the READ command will not mask these two data elements.

Figure 44: WRITE-to-READ – Odd Number of Data, Interrupting

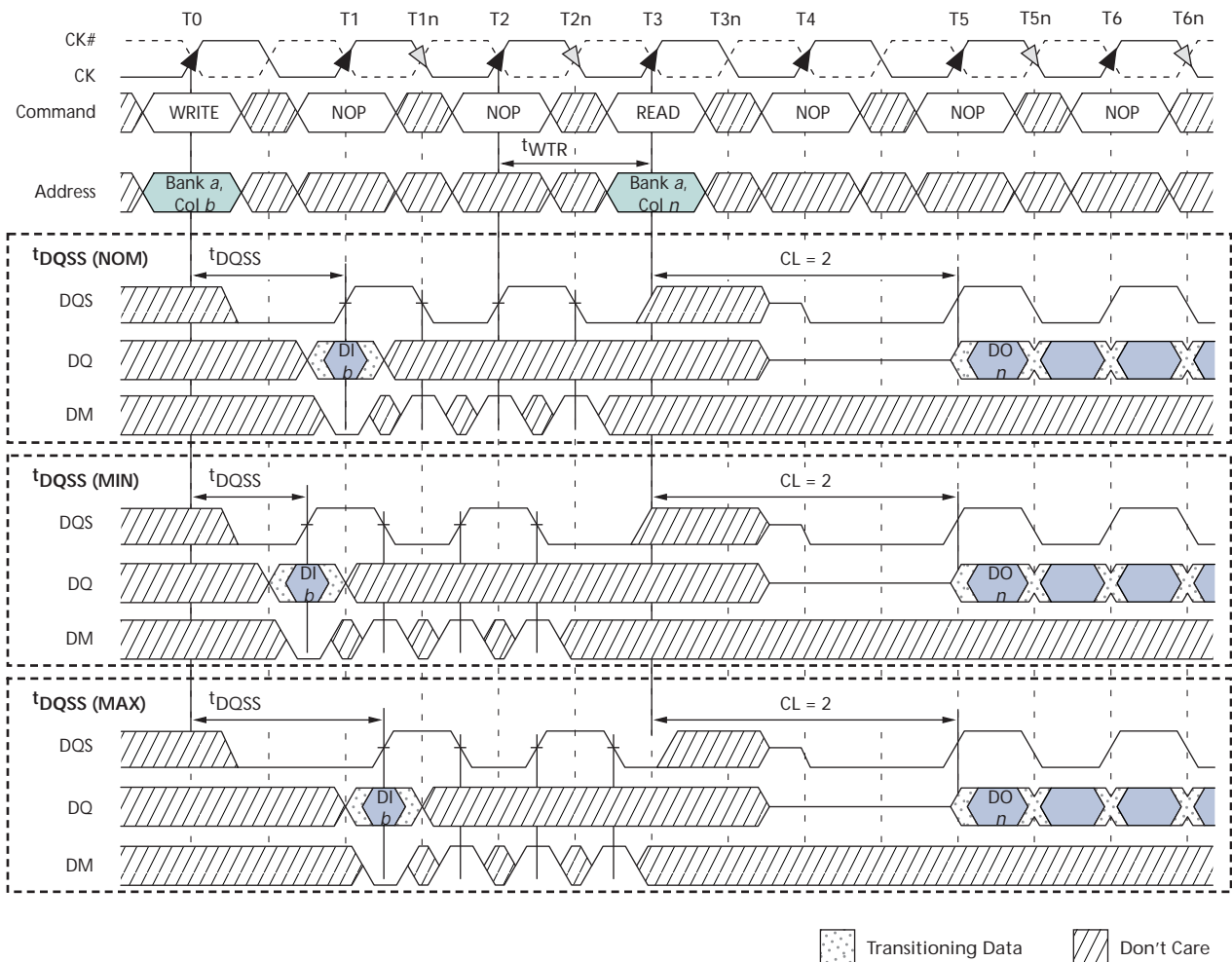

- Notes:
1. DI b = data-in for column b ; DO n = data-out for column n .
 2. An interrupted burst of 4 is shown; one data element is written.
 3. t_{WTR} is referenced from the first positive CK edge after the last desired data-in pair (not the last two data elements).
 4. A10 is LOW with the WRITE command (auto precharge is disabled).
 5. DQS is required at T1n, T2, and T2n (nominal case) to register DM.
 6. If the burst of 8 is used, DM and DQS are required at T3–T3n because the READ command will not mask these data elements.

Figure 45: WRITE-to-PRECHARGE - Uninterrupting

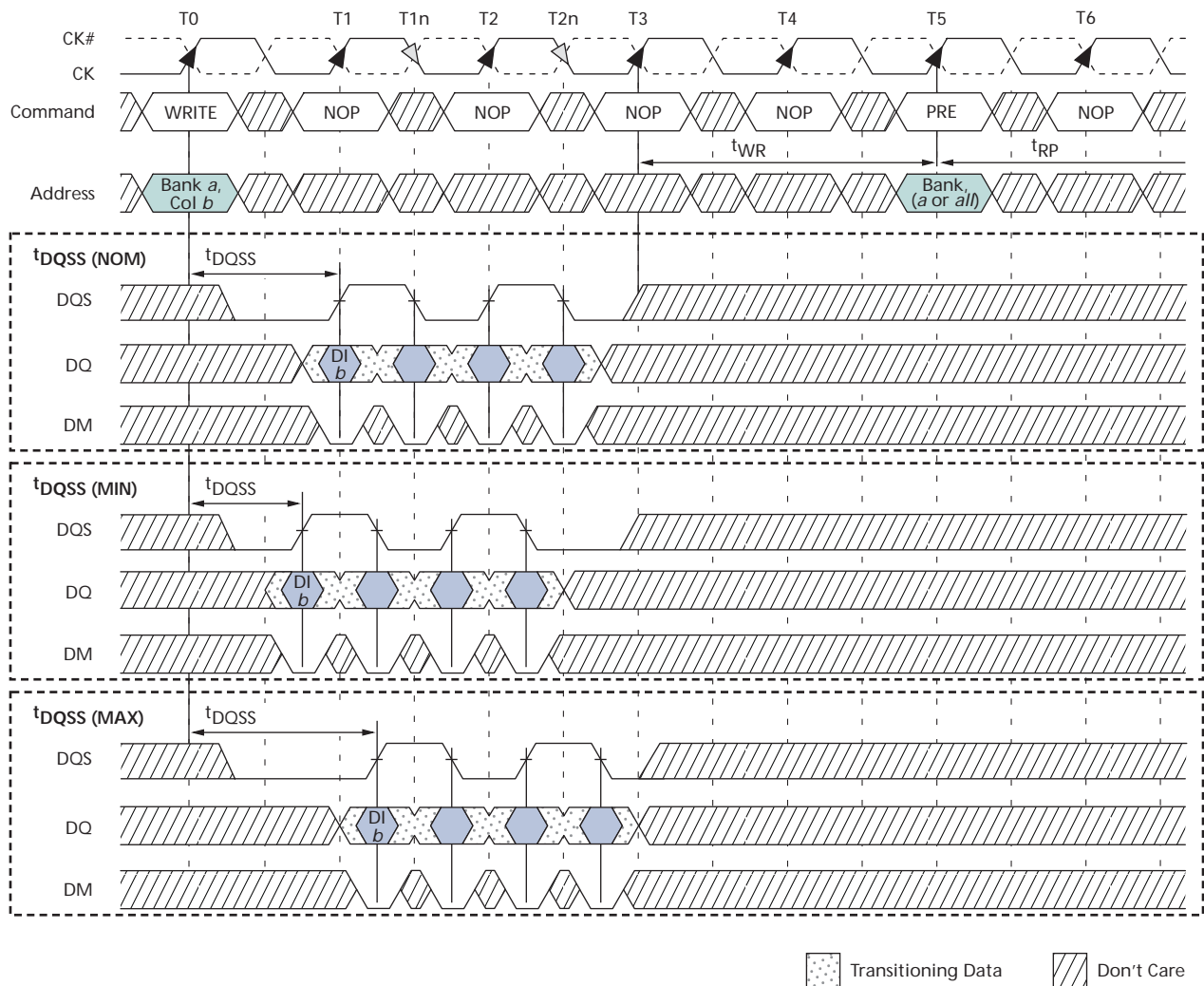

- Notes:
1. DI b = data-in for column b .
 2. Three subsequent elements of data-in are applied in the programmed order following DI b .
 3. An uninterrupted burst of 4 is shown.
 4. t_{WR} is referenced from the first positive CK edge after the last data-in pair.
 5. The PRECHARGE and WRITE commands are to the same device. However, the PRECHARGE and WRITE commands may be to different devices, in which case t_{WR} is not required, and the PRECHARGE command could be applied earlier.
 6. A10 is LOW with the WRITE command (auto precharge is disabled).

Figure 46: WRITE-to-PRECHARGE - Interrupting

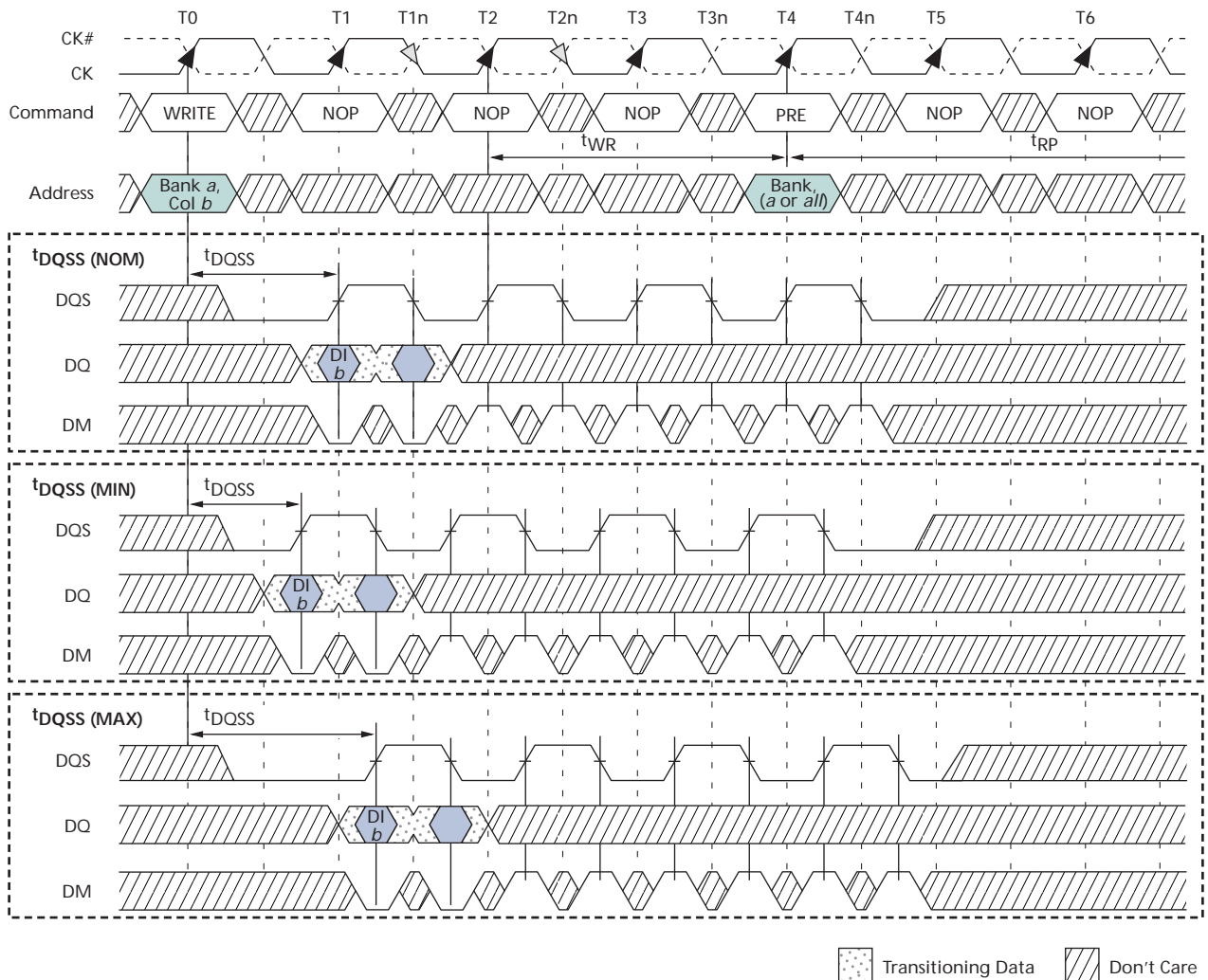

- Notes:
1. DI b = data-in for column b .
 2. Subsequent element of data-in is applied in the programmed order following DI b .
 3. An interrupted burst of 8 is shown; two data elements are written.
 4. t_{WR} is referenced from the first positive CK edge after the last data-in pair.
 5. A10 is LOW with the WRITE command (auto precharge is disabled).
 6. DQS is required at T4 and T4n (nominal case) to register DM.
 7. If the burst of 4 is used, DQS and DM are not required at T3, T3n, T4, and T4n.

Figure 47: WRITE-to-PRECHARGE - Odd Number of Data, Interrupting

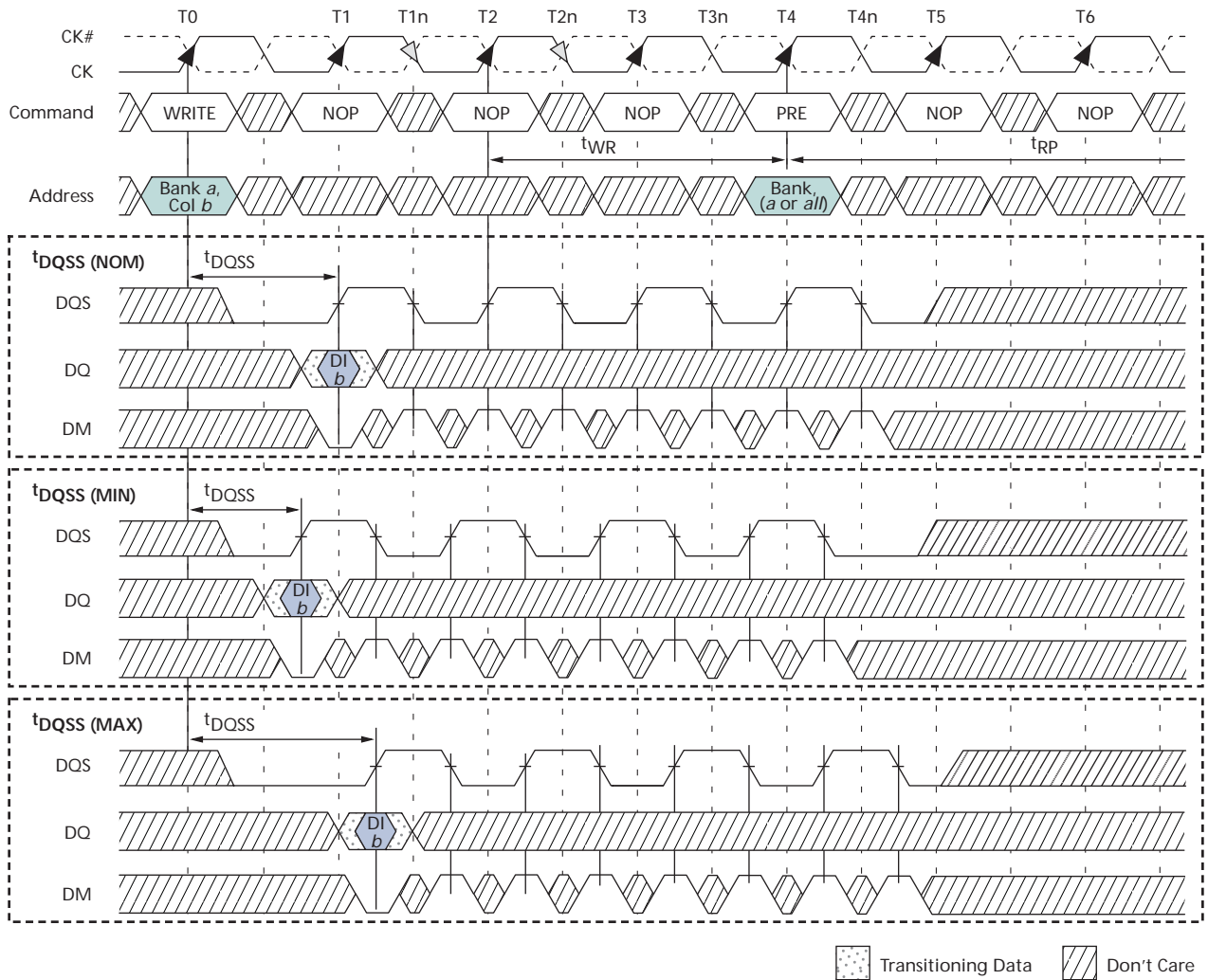

- Notes:
1. DI_b = data-in for column b .
 2. An interrupted burst of 8 is shown; one data element is written.
 3. t_{WR} is referenced from the first positive CK edge after the last data-in pair.
 4. A10 is LOW with the WRITE command (auto precharge is disabled).
 5. DQS is required at T_4 and T_{4n} (nominal case) to register DM.
 6. If the burst of 4 is used, DQS and DM are not required at T_3 , T_{3n} , T_4 , and T_{4n} .

Figure 48: Bank WRITE – Without Auto Precharge

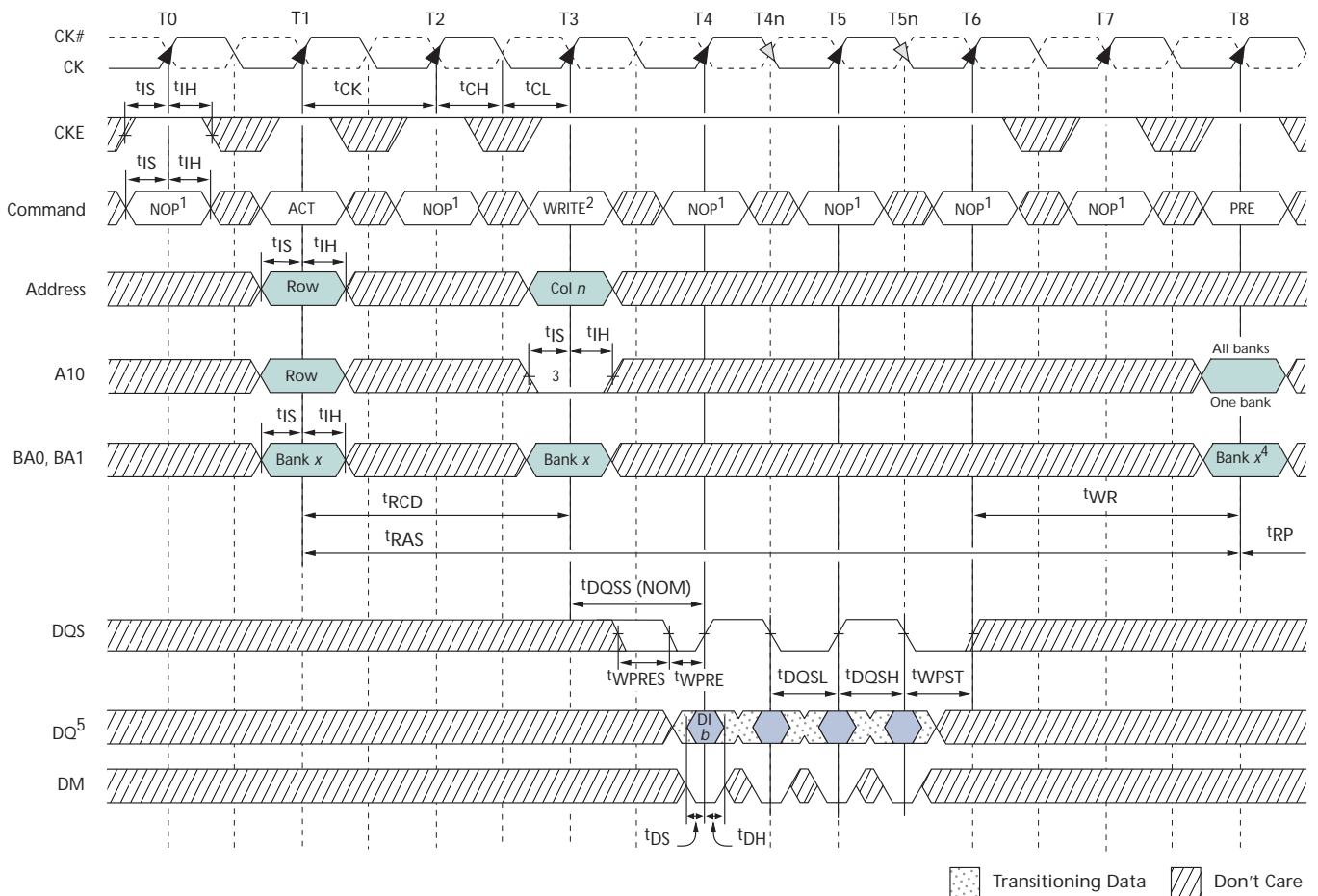

- Notes:
1. NOP commands are shown for ease of illustration; other commands may be valid at these times.
 2. BL = 4.
 3. Disable auto precharge.
 4. "Don't Care" if A10 is HIGH at T8.
 5. DI *b* = data-in from column *b*; subsequent elements are provided in the programmed order.
 6. See Figure 50 on page 85 for detailed DQ timing.

Figure 49: WRITE - DM Operation

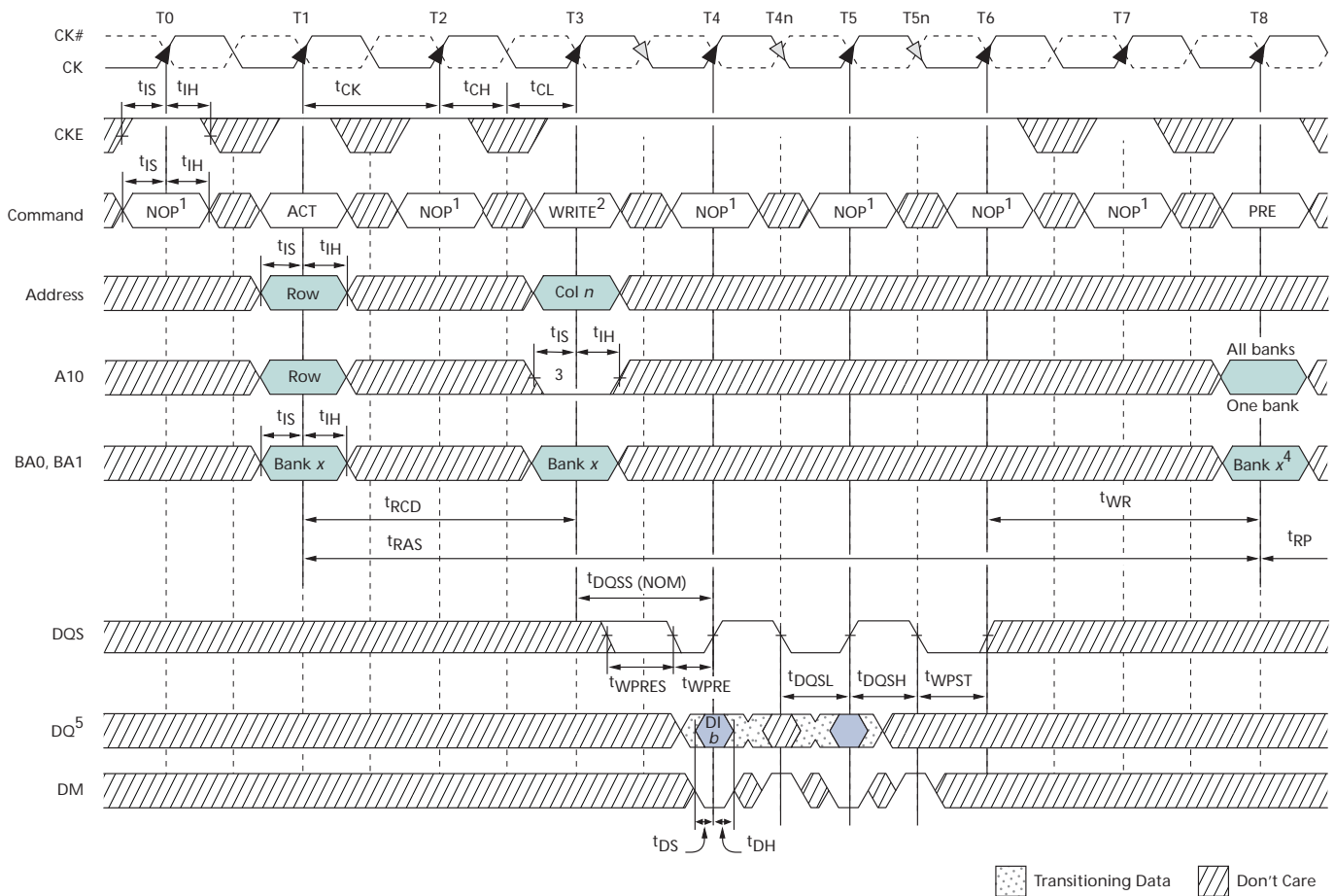

- Notes:
1. NOP commands are shown for ease of illustration; other commands may be valid at these times.
 2. BL = 4.
 3. Disable auto precharge.
 4. "Don't Care" if A10 is HIGH at T8.
 5. DI *b* = data-in from column *b*; subsequent elements are provided in the programmed order.
 6. See Figure 50 on page 85 for detailed DQ timing.

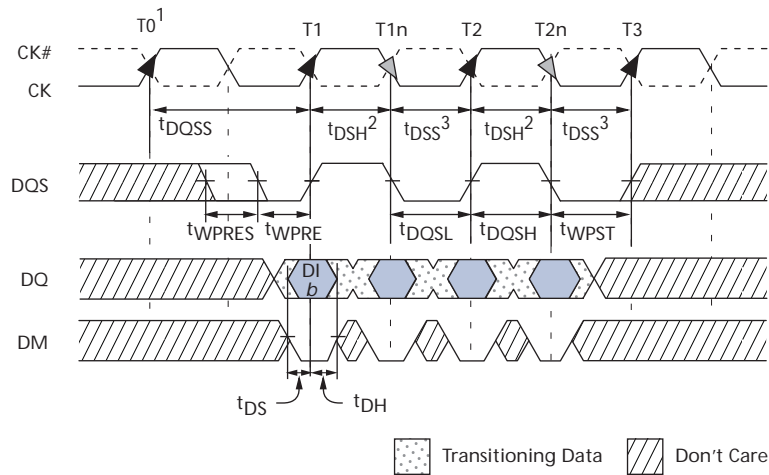
Figure 50: Data Input Timing

- Notes:
1. WRITE command issued at T_0 .
 2. t_{DSH}^2 (MIN) generally occurs during t_{DQSS} (MIN).
 3. t_{DSS}^3 (MIN) generally occurs during t_{DQSS} (MAX).
 4. For x16, LDQS controls the lower byte and UDQS controls the upper byte.
 5. DI b = data-in from column b .

PRECHARGE

The bank(s) will be available for a subsequent row access a specified time (t_{RP}) after the PRECHARGE command is issued, except in the case of concurrent auto precharge. With concurrent auto precharge, a READ or WRITE command to a different bank is allowed as long as it does not interrupt the data transfer in the current bank and does not violate any other timing parameters. Input A10 determines whether one or all banks are to be precharged, and in the case where only one bank is to be precharged, inputs BA0, BA1 select the bank. When all banks are to be precharged, BA0, BA1 are treated as “Don’t Care.” Once a bank has been precharged, it is in the idle state and must be activated prior to any READ or WRITE commands being issued to that bank. A PRECHARGE command will be treated as a NOP if there is no open row in that bank (idle state), or if the previously open row is already in the process of precharging.

Auto Precharge

Auto precharge is a feature which performs the same individual-bank precharge function described above, but without requiring an explicit command. This is accomplished by using A10 to enable auto precharge in conjunction with a specific READ or WRITE command. A precharge of the bank/row that is addressed with the READ or WRITE command is automatically performed upon completion of the READ or WRITE burst. Auto precharge is either enabled or disabled for each individual READ or WRITE command. This device supports concurrent auto precharge if the command to the other bank does not interrupt the data transfer to the current bank.

Auto precharge ensures that the precharge is initiated at the earliest valid stage within a burst. This “earliest valid stage” is determined as if an explicit PRECHARGE command was issued at the earliest possible time, without violating t_{RAS} (MIN), as described for each burst type in “Operations” on page 52. The user must not issue another command to the same bank until the precharge time (t_{RP}) is completed.

Figure 51: Bank READ - with Auto Precharge

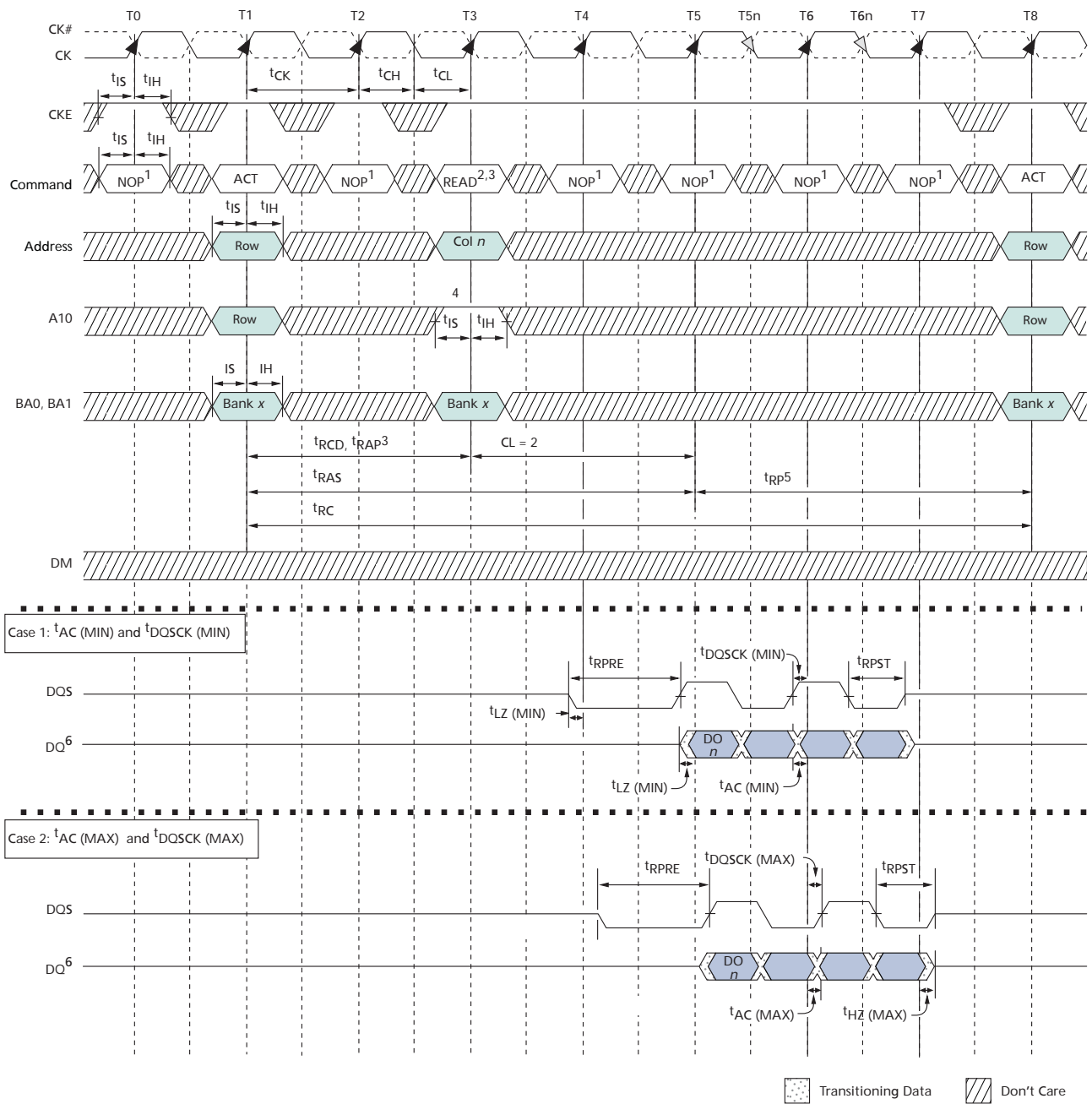

- Notes:
1. NOP commands are shown for ease of illustration; other commands may be valid at these times.
 2. BL = 4.
 3. The READ command can only be applied at T3 if t_{RAP} is satisfied at T3.
 4. Enable auto precharge.
 5. t_{RP} starts only after t_{RAS} has been satisfied.
 6. DO n = data-out from column n ; subsequent elements are provided in the programmed order.
 7. Refer to Figure 35 on page 70, Figure 36 on page 71, and Figure 37 on page 72 for detailed DQS and DQ timing.

Figure 52: Bank WRITE – with Auto Precharge

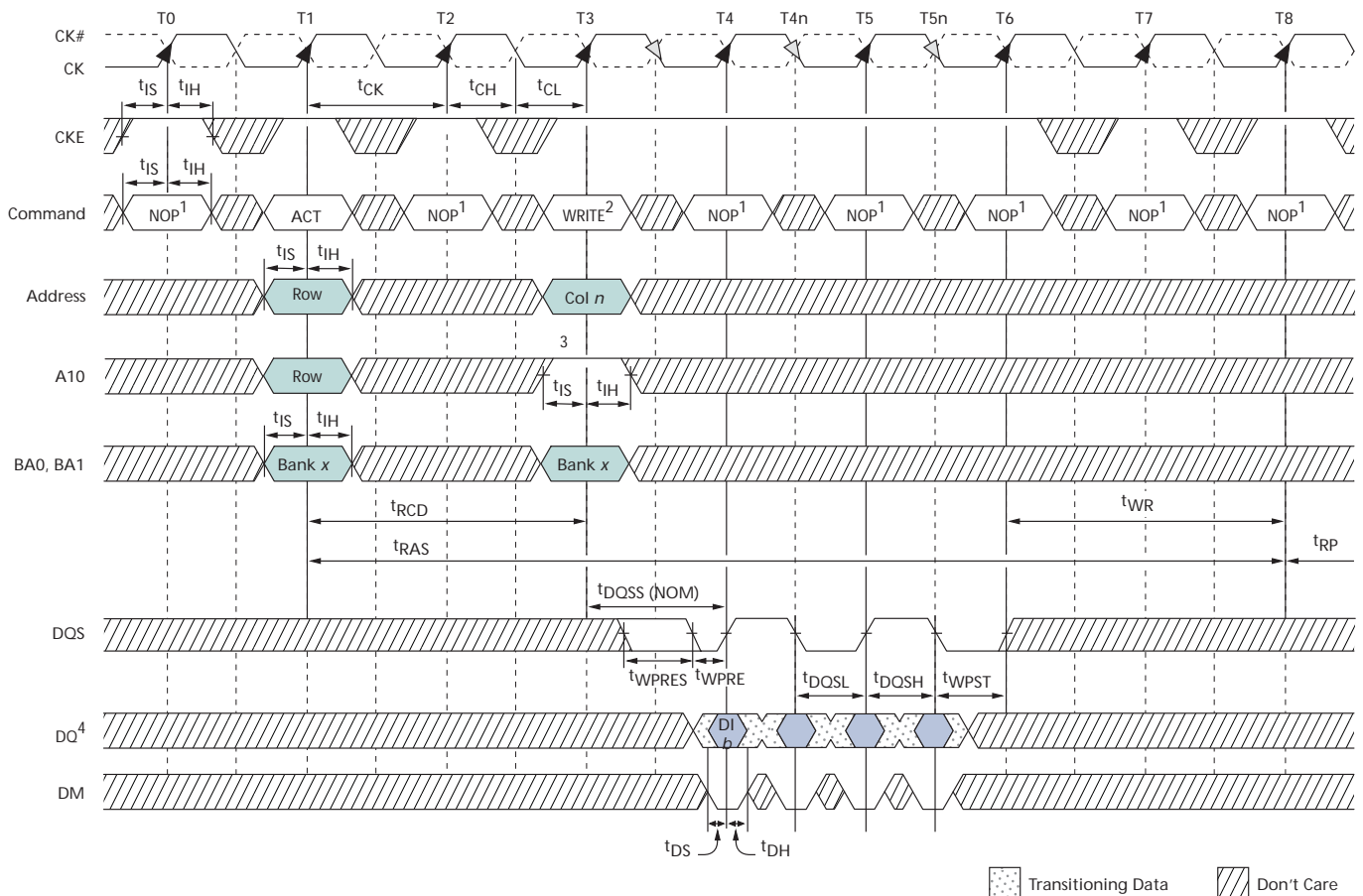

- Notes:
1. NOP commands are shown for ease of illustration; other commands may be valid at these times.
 2. BL = 4.
 3. Enable auto precharge.
 4. DI n = data-out from column n ; subsequent elements are provided in the programmed order.
 5. See Figure 50 on page 85 for detailed DQ timing.

AUTO REFRESH

During auto refresh, the addressing is generated by the internal refresh controller. This makes the address bits a “Don’t Care” during an AUTO REFRESH command. The DDR SDRAM requires AUTO REFRESH cycles at an average interval of $t_{REFI} (MAX)$.

To allow for improved efficiency in scheduling and switching between tasks, some flexibility in the absolute refresh interval is provided. A maximum of eight AUTO REFRESH commands can be posted to any given DDR SDRAM, meaning that the maximum absolute interval between any AUTO REFRESH command and the next AUTO REFRESH command is $9 \times t_{REFI} (= t_{REFC})$. JEDEC specifications only support $8 \times t_{REFI}$; Micron specifications exceed the JEDEC requirement by one clock. This maximum absolute interval is to allow future support for DLL updates, internal to the DDR SDRAM, to be restricted to AUTO REFRESH cycles, without allowing excessive drift in t_{AC} between updates.

Although not a JEDEC requirement, to provide for future functionality features, CKE must be active (HIGH) during the AUTO REFRESH period. The AUTO REFRESH period begins when the AUTO REFRESH command is registered and ends t_{RFC} later.

Figure 53: Auto Refresh Mode

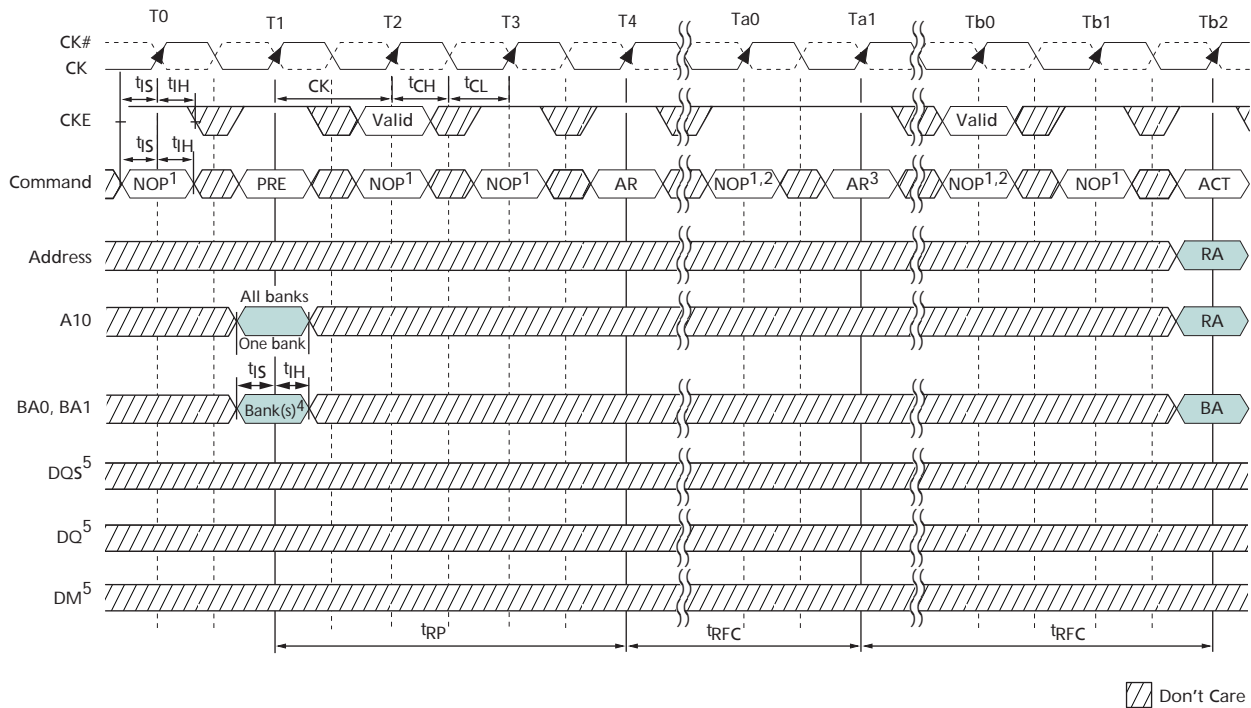

- Notes:
1. NOP commands are shown for ease of illustration; other valid commands may be possible at these times. CKE must be active during clock-positive transitions.
 2. NOP or COMMAND INHIBIT are the only commands allowed until after t_{RFC} time; CKE must be active during clock-positive transitions.
 3. The second AUTO REFRESH is not required and is only shown as an example of two back-to-back AUTO REFRESH commands.
 4. "Don't Care" if A10 is HIGH at this point; A10 must be HIGH if more than one bank is active (that is, must precharge all active banks).
 5. DM, DQ, and DQS signals are all "Don't Care"/High-Z for the operations shown.

SELF REFRESH

When in the self refresh mode, the DDR SDRAM retains data without external clocking. The DLL is automatically disabled upon entering SELF REFRESH and is automatically enabled upon exiting SELF REFRESH (a DLL reset and 200 clock cycles must then occur before a READ command can be issued). Input signals except CKE are "Don't Care" during SELF REFRESH. V_{REF} voltage is also required for the full duration of SELF REFRESH.

The procedure for exiting SELF REFRESH requires a sequence of commands. First, CK and CK# must be stable prior to CKE going back HIGH. Once CKE is HIGH, the DDR SDRAM must have NOP commands issued for t_{XSNR} because time is required for the completion of any internal refresh in progress. A simple algorithm for meeting both refresh and DLL requirements is to apply NOPS for t_{XSRD} time, then a DLL RESET (via

the extended mode register) and NOPs for 200 additional clock cycles before applying a READ. Any command other than a READ can be performed t_{XSNR} (MIN) after the DLL reset. NOP or DESELECT commands must be issued during the t_{XSNR} (MIN) time.

Self refresh is not supported on automotive temperature (AT) devices.

Figure 54: Self Refresh Mode

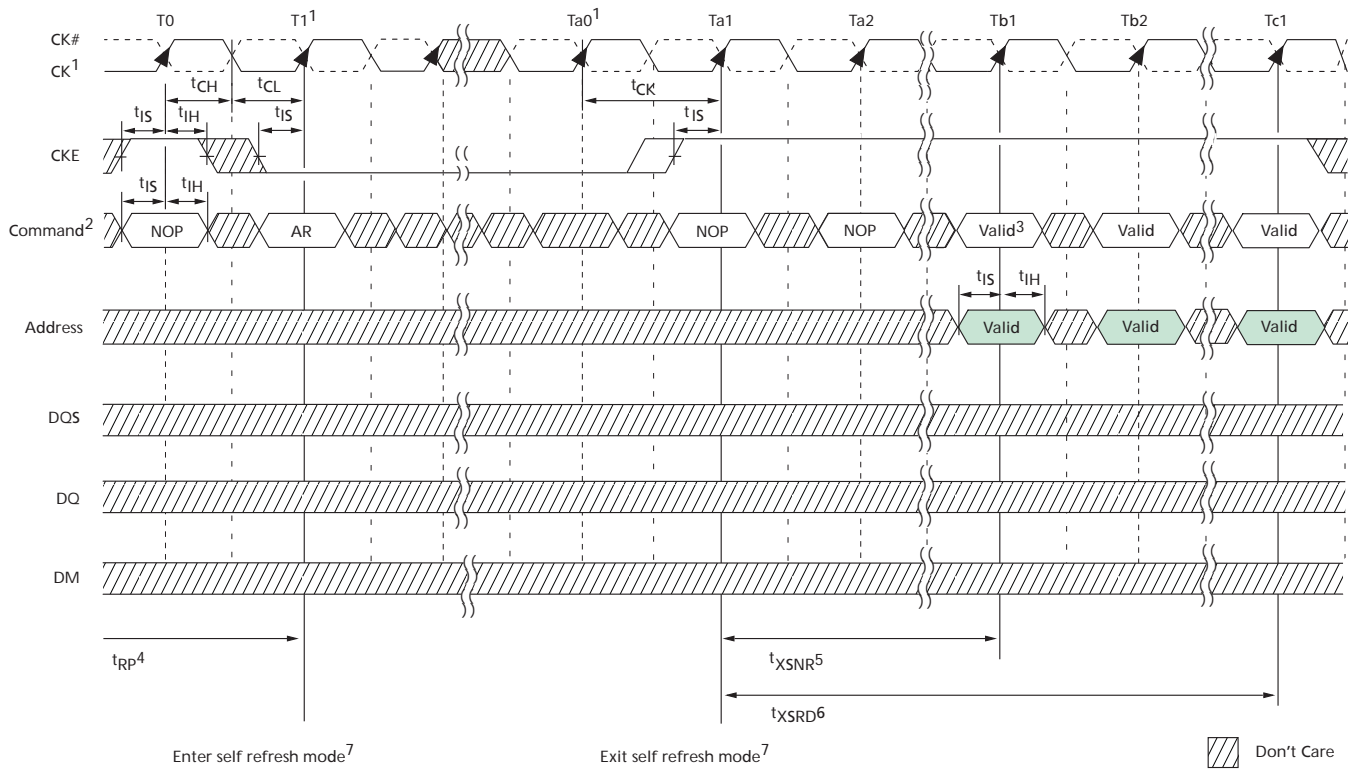

- Notes:
1. Clock must be stable until after the SELF REFRESH command has been registered. A change in clock frequency is allowed before Ta0, provided it is within the specified t_{CK} limits. Regardless, the clock must be stable before exiting self refresh mode—that is, the clock must be cycling within specifications by Ta0.
 2. NOPs are interchangeable with DESELECT commands.
 3. AUTO REFRESH is not required at this point but is highly recommended.
 4. Device must be in the all banks idle state prior to entering self refresh mode.
 5. t_{XSNR} is required before any non-READ command can be applied; that is only NOP or DESELECT commands are allowed until Tb1.
 6. t_{XSRD} (200 cycles of a valid clock with CKE = HIGH) is required before any READ command can be applied.
 7. As a general rule, any time self refresh mode is exited, the DRAM may not re-enter the self refresh mode until all rows have been refreshed via the AUTO REFRESH command at the distributed refresh rate, t_{REFI} , or faster. However, the self refresh mode may be re-entered anytime after exiting if each of the following conditions is met:
 - 7a. The DRAM had been in the self refresh mode for a minimum of 200ms prior to exiting.
 - 7b. t_{XSNR} and t_{XSRD} are not violated.
 - 7c. At least two AUTO REFRESH commands are performed during each t_{REFI} interval while the DRAM remains out of self refresh mode.
 8. If the clock frequency is changed during self refresh mode, a DLL reset is required upon exit.
 9. Once the device is initialized, VREF must always be powered within specified range.

Power-down (CKE Not Active)

Unlike SDR SDRAMs, DDR SDRAMs require CKE to be active at all times an access is in progress, from the issuing of a READ or WRITE command, until completion of the access. Thus a clock suspend is not supported. For READs, an access completion is defined when the read postamble is satisfied; for WRITEs, when the write recovery time (t_{WR}) is satisfied.

Power-down, as shown in Figure 55 on page 91, is entered when CKE is registered LOW and all criteria in Table 33 on page 47 are met. If power-down occurs when all banks are idle, this mode is referred to as precharge power-down; if power-down occurs when a row is active in any bank, this mode is referred to as active power-down. Entering power-down deactivates the input and output buffers, excluding CK, CK#, and CKE. For maximum power savings, the DLL is frozen during precharge power-down mode. Exiting power-down requires the device to be at the same voltage and frequency as when it entered power-down. However, power-down duration is limited by the refresh requirements of the device (t_{REFC} or $t_{REFC_{AT}}$).

While in power-down, CKE LOW and a stable clock signal must be maintained at the inputs of the DDR SDRAM, while all other input signals are "Don't Care." The power-down state is synchronously exited when CKE is registered HIGH (in conjunction with a NOP or DESELECT command). A valid executable command may be applied one clock cycle later.

Figure 55: Power-Down Mode

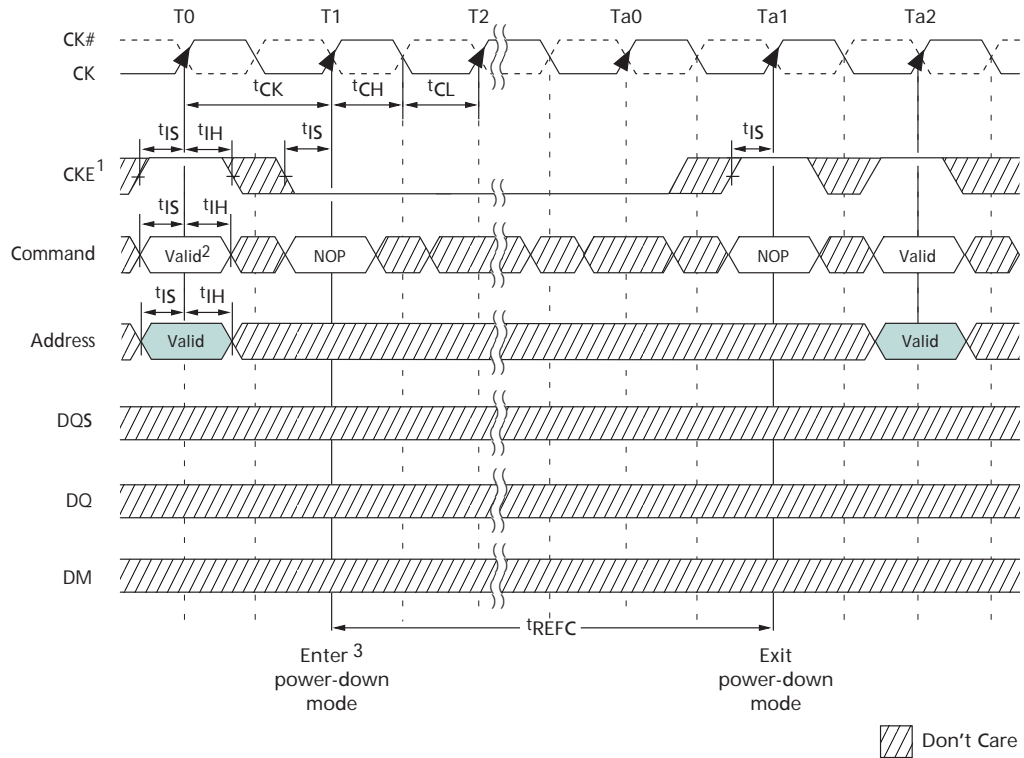

- Notes:
1. Once initialized, V_{REF} must always be powered within the specified range.
 2. If this command is a PRECHARGE (or if the device is already in the idle state), then the power-down mode shown is precharge power-down. If this command is an ACTIVE (or if at least one row is already active), then the power-down mode shown is active power-down.
 3. No column accesses are allowed to be in progress at the time power-down is entered.

8000 S. Federal Way, P.O. Box 6, Boise, ID 83707-0006, Tel: 208-368-3900
www.micron.com/productsupport Customer Comment Line: 800-932-4992

Micron and the Micron logo are trademarks of Micron Technology, Inc. All other trademarks are the property of their respective owners. This data sheet contains minimum and maximum limits specified over the power supply and temperature range set forth herein. Although considered final, these specifications are subject to change, as further product development and data characterization sometimes occur.