

LQ070Y3DG3A LCD Module

Product Specification

February 2009

WVGA Module featuring LED backlight,
16:9 aspect ratio, excellent color rendition,
350 nits brightness, and 300:1 contrast.

Full Specifications Listing

SHARP[®]

APREPARED BY : DATE	<h1>SHARP</h1> <p>MOBILE LIQUID CRYSTAL DISPLAY GROUP SHARP CORPORATION</p> <h2>SPECIFICATION</h2>	SPEC No. LD-21212A
APPROVED BY : DATE		FILE No.
		ISSUE : Feb. 17. 2009
		PAGE : 19 pages
		APPLICABLE GROUP MOBILE LIQUID CRYSTAL DISPLAY GROUP

DEVICE SPECIFICATION FOR

TFT-LCD Module

 MODEL No.

LQ070Y3DG3A

CUSTOMER'S APPROVAL

DATE _____

BY _____

PRESENTED

BY *K. Shiono*

K. SHIONO
 Department General Manager
 Engineering Dept. I
 MOBILE LCD DIVISION III
 MOBILE LIQUID CRYSTAL DISPLAY GROUP
 SHARP CORPORATION

These specification sheets are the proprietary product of SHARP CORPORATION("SHARP) and include materials protected under copyright of SHARP. Do not reproduce or cause any third party to reproduce them in any form or by any means, electronic or mechanical, for any purpose, in whole or in part, without the express written permission of SHARP.

In case of using the device for applications such as control and safety equipment for transportation(aircraft, trains, automobiles, etc.), rescue and security equipment and various safety related equipment which require higher reliability and safety, take into consideration that appropriate measures such as fail-safe functions and redundant system design should be taken.

Do not use the device for equipment that requires an extreme level of reliability, such as aerospace applications, telecommunication equipment(trunk lines), nuclear power control equipment and medical or other equipment for life support.

SHARP assumes no responsibility for any damage resulting from the use of the device, which does not comply with the instructions, and the precautions specified in these specification sheets.

Contact and consult with a SHARP sales representative for any questions about this device.

Table of contents

1. Application	3
2. Overview	3
3. Mechanical Specifications	3
4. Input Terminals	4
4-1. TFT-LCD panel driving	4
4-2. LED- Backlight driving	4
5. Absolute Maximum Ratings	5
6. Electrical Characteristics	5
6-1. TFT-LCD panel driving	5
6-2. Backlight driving	7
7. Timing Characteristics of Input Signals	7
7-1. Timing characteristics	7
7-2. Display position	8
7-3. Input data signals and display position on the screen	8
Fig 1. Input signal timing chart	9
8. Input Signals, Basic Display Colors and Gray Scale of Each Color	10
9. Optical Characteristics	11
10. Display Quality	12
11. Handling Precautions	13
12. Packing form	14
13. Reliability Test Items	14
14. Label	15
15. Storage conditions	16
Fig 2. Packing form	17
Fig 3. Outline demensions	18

1. Application

This specification applies to a color TFT-LCD module, LQ070Y3DG3A.

2. Overview

This module is a color active matrix LCD module incorporating amorphous silicon TFT (Thin Film Transistor). It is composed of a color TFT-LCD panel, driver ICs, power supply circuit, and a backlight unit. Graphics and texts can be displayed on a 800×3×480 dots panel with 16,194,277 colors by supplying 24bit digital signal interface (RGB × 8bit) and supplying +3.3V DC supply voltages for TFT-LCD panel driving and supply voltage for backlight.

In this TFT-LCD panel, low reflection / color filters of excellent color performance and backlights of high brightness are incorporated to realize brighter and clearer pictures, making this model optimum for use in multi-media applications.

Optimum viewing direction is 6 o'clock.

Backlight-driving DC/DC converter is not built in this module.

3. Mechanical Specifications

Parameter	Specifications	Unit
Display size	17.8 (7.0") Diagonal	cm
Active area	152.4(H)×91.4 (V)	mm
Pixel format	800 (H)×480 (V)	pixel
	(1 pixel = R+G+B dots)	
Aspect ratio	15 : 9	
Pixel pitch	0.1905 (H)×0.1905 (V)	mm
Pixel configuration	R,G,B Horizontal stripe	
Display mode	Normally white	
Surface treatment	Anti-Glare and hard-coating 2H	

Parameter		Min.	Typ.	Max.	Unit	Remark
Unit outline dimensions [Note 1]	Width	162.9	163.2	163.5	mm	[Note 1]
	Height	103.7	104.0	104.3	mm	
	Depth	-	3.9	4.2	mm	
		-	-	6.3	mm	[Note 2]
Mass		-	135	150	g	

[Note 1] Excluding the FPC/FFC and parts mounting area.

Outline dimensions is shown in Fig.3

[Note 2] Including the FPC/FFC and parts mounting area.

4. Input Terminals

4-1. TFT-LCD panel driving

CN1(Timing signals,DATA signals and +3.3V DC power supply)

Pin No.	Symbol	Function	Pin No.	Symbol	Function
1	GND		21	B0	BLUE data signal(LSB)
2	GND		22	B1	BLUE data signal
3	VCC	+3.3V Power Supply	23	B2	BLUE data signal
4	VCC	+3.3V Power Supply	24	B3	BLUE data signal
5	R0	RED data signal(LSB)	25	B4	BLUE data signal
6	R1	RED data signal	26	B5	BLUE data signal
7	R2	RED data signal	27	B6	BLUE data signal
8	R3	RED data signal	28	B7	BLUE data signal(MSB)
9	R4	RED data signal	29	GND	
10	R5	RED data signal	30	DOTCLK	Dot-clock signal
11	R6	RED data signal	31	NC	
12	R7	RED data signal(MSB)	32	HSYNC	Line synchronization signal
13	G0	GREEN data signal(LSB)	33	VSYNC	Frame synchronization signal
14	G1	GREEN data signal	34	DEN	Display enable signal
15	G2	GREEN data signal	35	NC	
16	G3	GREEN data signal	36	NC	
17	G4	GREEN data signal	37	GND	
18	G5	GREEN data signal	38	GND	
19	G6	GREEN data signal	39	NC	
20	G7	GREEN data signal(MSB)	40	NC	

[Note 1] Please use NC by OPEN or GND. NC terminal is not connected with the internal circuit.

Using FFC : SML2CD-40X77.5-ADX7(BL)-P0.5-S4.0+4.0-M-N(35)-AUP-HF

UL21147(Sumitomo Electric Industries, Ltd)

Recommendation connector : FH28-40S-0.5SH(0.5) (HIROSE):Bottom contact

FH12A-40S-0.5SH(55) (HIROSE):Top contact

(Sharp is not responsible to its product quality, if the user applies a connector not corresponding to the above model.)

4-2. LED- Backlight driving

Pin No.	Symbol	Function
1	LED-A1	Power supply for LED (Anode)
2	LED-C1	Power supply for LED (Cathode)
3	LED-A2	Power supply for LED (Anode)
4	LED-C2	Power supply for LED (Cathode)
5	LED-A3	Power supply for LED (Anode)
6	LED-C3	Power supply for LED (Cathode)

[Note 1]LED-FPC outline dimensions is shown in Fig.3

Recommendation connector: 04-6298-006-000-883+ (Kyosera) : Bottom contact

04-6277-006-000 or 001-883+ (Kyosera) : Double-sided contact

5. Absolute Maximum Ratings

Parameter	Symbol	Condition	Ratings		Unit	Remark
			Min.	Max.		
Input voltage	V_I	Ta=25	-0.3	V _{CC} +0.3	V	[Note 1]
+3.3V supply voltage	V _{CC}	Ta=25	0	+4.0	V	
LED forward current	I _{LED}	Ta=25	0	30	mA	[Note 2]
LED reverse voltage	V _{LED_R}	Ta=25	-	5	V	
Storage temperature	T _{stg}	-	-30	+70		[Note 3]
Operating temperature	T _{opa}	-	-20	+50		

[Note 1] R0-7、G0-7、B0-7、DOTCLK、HSYNC、VSYNC、DEN

[Note 2] LED_A to LED_Cn (n=1,2,3) Absolute maximum ratings for each pair.

[Note 3] Humidity : 95%RH Max. at Ta +40 .

Maximum wet-bulb temperature at +39 or less at Ta>+40 .

No condensation.

6. Electrical Characteristics

6-1. TFT-LCD panel driving

Ta = +25

Parameter	Symbol	Min.	Typ.	Max.	Unit	Remark
Supply voltage	V _{CC}	+3.0	+3.3	+3.6	V	[Note 1]
Current dissipation	I _{CC}	-	140	185	mA	[Note 2]
Permissive input ripple voltage	V _{RP}	-	-	100	mV _{P-P}	V _{CC} = +3.3V
Input voltage range	High	V _{TH}	-	$0.3 \times V_{CC}$	mV	[Note 3, 4]
	Low	V _{TL}	$0.7 \times V_{CC}$	-	mV	
Input leak current	High	I _{OH}	-	± 10	μA	V _I = V _{CC} [Note 3, 4]
	Low	I _{OL}	-	± 10	μA	V _I = 0V [Note 3, 4]

[Note 1] On-off conditions for supply voltage

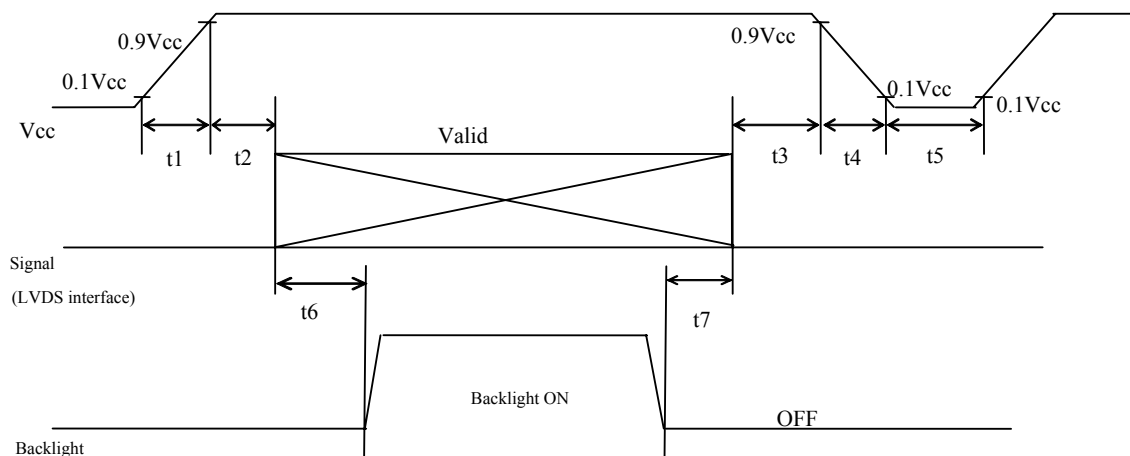

Symbol	Min.	Max.	Unit	Remark
t1	0	10	ms	
t2	0	1	ms	
t3	0	1	ms	
t4	0	400	ms	
t5	1	-	s	
t6	180	-	ms	*1
t7	5	-	ms	*1

*1 : As for the power sequence for backlight, it is recommended to apply above mentioned input timing. If the backlight is lit on and off at a timing other than shown above, displaying image may get disturbed.

[Note] Do not keep the interface signal high-impedance or unusual signal when power is on.

Vcc-dip conditions

- 1) 2.5 V $V_{CC} < 3.0 V$
 t_d 10 ms

Under above condition, the display image should return to an appropriate figure after Vcc voltage recovers.

- 2) $V_{CC} < 2.5 V$

Vcc-dip conditions should also follow the On-off conditions for supply voltage

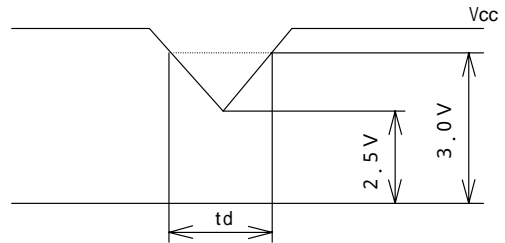

[Note 2] Typical current situation :

$V_{CC} = +3.3V, f_{VSYNC} = 60Hz$

Measuring pattern:GS-0-GS60 Vertical gray scale.

GS(4n) n:Natural number(0 ~ 15)

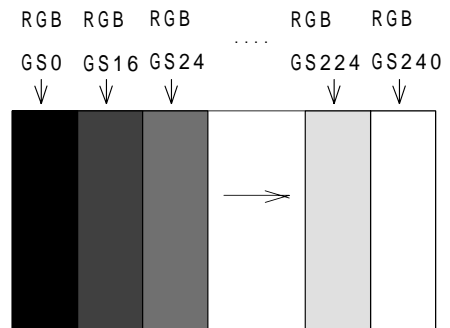

[Note 3] R0-7、G0-7、B0-7、DOTCLK、HSYNC、VSYNC、DEN

[Note 4] Interface block diagram of the LCD

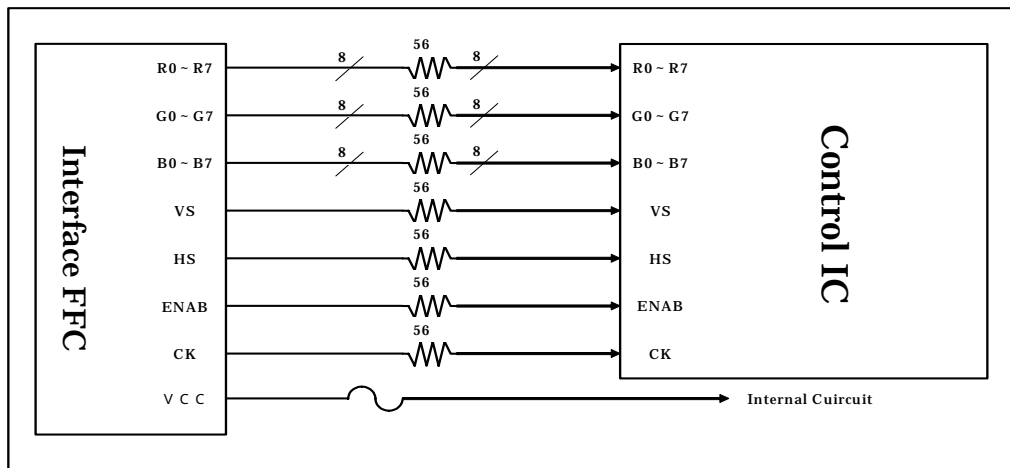

6-2. Backlight driving

The backlight system is edge-lighting type with 24 White-LED(White Light Emitting Diode).

The characteristics of White-LED are shown in the following table. (Ta=25 °C)

Parameter	Symbol	Min.	Typ.	Max.	Unit	Remark
LED voltage	V_L	-	25.6	28	V	$I_L=20\text{mA}$
LED current range	I_L	-	20	25	mA	
Number of circuit strings		-	3	-		[Note 1]
LED power consumption	W_L	-	1.54	-	W	[Note 2]
LED life time	L_L	10000	-	-	Hour	[Note 3]

[Note 1] The LED backlight is composed by 3 strings from which 8 LED is connected with the series.

The figure below shows the circuit chart.

In each string, there is a ceramic capacitor for the electrostatic protection.

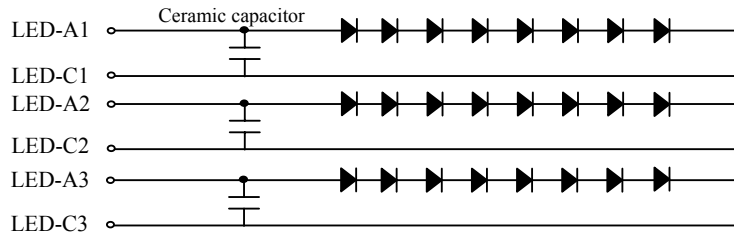

[Note 2] Calculated value for reference ($I_L \times V_L$)

[Note 3] LED life time is defined as the time when Brightness becomes 50 % of the original value.
under the condition of $T_a = 25$ and $I_L = 20$ mA, and continuous lighting.

7. Timing Characteristics of Input Signals

7-1. Timing characteristics

Characteristics		Symbol	Min.	Typ.	Max.	Unit	Remark
DOTCLK	Frequency	$1/T_c$	31.95	33.26	34.6	MHz	
	High Width	T_{ch}	10	-	-	ns	
	Lo Width	T_{cl}	10	-	-	ns	
	Duty	T_h/T	40	50	60	%	
DATA	Setup Time	T_{ds}	5	-	-	ns	
	Hold Time	T_{dh}	5	-	-	ns	
HSYNC	Period	TH	31.45	31.75	-	μs	
			1024	1056	1088	clock	
	Pulse Width	THp	5	128	186	clock	
VSYNC	Period	TV	520	525	530	line	
	Pulse Width	TVp	2	-	TV-515	line	
Horizontal Display Area		THd	800	800	800	line	
Phase difference of HSYNC - DOTCLK		THc	8	-	T_c-10	ns	
Phase difference of HSYNC - VSYNC		TVh	1	-	$TH-THp-10$	clock	
Vertical Back Porch		TVs	35	35	35	line	
Vertical Front Porch		TVf	5	-	-	line	
Vertical Display Area		TVd	480	480	480	line	

[Note1] In case of lower frequency, the deterioration of display quality, flicker etc., may be occurred.

7-2. Display position

Characteristics		Symbol	Min.	Typ.	Max.	Unit	Remark
DEN	Setup time	Tes	5	-	Tc-10	ns	
	Pulse width	Tep	-	800	-	clock	
Phase difference of HSYNC - DEN		THe	88	-	215	clock	

[Note]

(Horizontal display direction)

When “DEN” signal is fixed low, 216 clocks are counted from Hsync negative edge and data from after are available. If you need other timing, please use “DEN” signal.

(Vertical display direction)

36 lines are counted from Vsync negative edge and data from next line are available.

(“DEN” signal)

When “DEN” signal is active, “ DEN” signal input continuously or fixed “L” in Vertical invalid data period.

Caution

Image will not be displayed on the right position otherwise.

7-3. Input data signals and display position on the screen

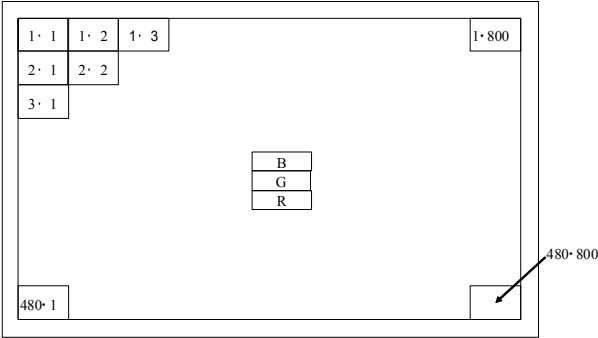

Display position of input data(V · H)

8. Input Signals, Basic Display Colors and Gray Scale of Each Color

Colors & Gray scale	Grav Scale	Data signal																							
		R0	R1	R2	R3	R4	R5	R6	R7	G0	G1	G2	G3	G4	G5	G6	G7	B0	B1	B2	B3	B4	B5	B6	B7
Basic Color	Black	-	0	0	0	0	0	0	0	0	0	0	0	0	0	0	0	0	0	0	0	0	0	0	0
	Blue	-	0	0	0	0	0	0	0	0	0	0	0	0	0	0	0	0	X	X	1	1	1	1	1
	Green	-	0	0	0	0	0	0	0	0	X	X	1	1	1	1	1	1	0	0	0	0	0	0	0
	Cyan	-	0	0	0	0	0	0	0	0	X	X	1	1	1	1	1	1	X	X	1	1	1	1	1
	Red	-	X	X	1	1	1	1	1	1	0	0	0	0	0	0	0	0	0	0	0	0	0	0	0
	Magenta	-	X	X	1	1	1	1	1	1	0	0	0	0	0	0	0	0	X	X	1	1	1	1	1
	Yellow	-	X	X	1	1	1	1	1	1	X	X	1	1	1	1	1	1	0	0	0	0	0	0	0
	White	-	X	X	1	1	1	1	1	1	X	X	1	1	1	1	1	1	X	X	1	1	1	1	1
Gray Scale of Red	Black	GS0	0	0	0	0	0	0	0	0	0	0	0	0	0	0	0	0	0	0	0	0	0	0	
	↑	GS1	1	0	0	0	0	0	0	0	0	0	0	0	0	0	0	0	0	0	0	0	0	0	
	Darker	GS2	0	1	0	0	0	0	0	0	0	0	0	0	0	0	0	0	0	0	0	0	0	0	
	↑	↓																							
		↓																							
		GS250	0	1	0	1	1	1	1	1	0	0	0	0	0	0	0	0	0	0	0	0	0	0	0
	↓	GS251	1	1	0	1	1	1	1	1	0	0	0	0	0	0	0	0	0	0	0	0	0	0	0
	Brighter	GS252	X	X	1	1	1	1	1	1	0	0	0	0	0	0	0	0	0	0	0	0	0	0	0
	↓	↓																							
	Red	GS255	X	X	1	1	1	1	1	1	0	0	0	0	0	0	0	0	0	0	0	0	0	0	0
Gray Scale of Green	Black	GS0	0	0	0	0	0	0	0	0	0	0	0	0	0	0	0	0	0	0	0	0	0	0	
	↑	GS1	0	0	0	0	0	0	0	0	1	0	0	0	0	0	0	0	0	0	0	0	0	0	
	Darker	GS2	0	0	0	0	0	0	0	0	0	1	0	0	0	0	0	0	0	0	0	0	0	0	
	↑	↓																							
		↓																							
		GS250	0	0	0	0	0	0	0	0	0	1	0	1	1	1	1	1	0	0	0	0	0	0	0
	↓	GS251	0	0	0	0	0	0	0	0	1	1	0	1	1	1	1	1	0	0	0	0	0	0	0
	Brighter	GS252	0	0	0	0	0	0	0	0	X	X	1	1	1	1	1	1	0	0	0	0	0	0	0
	↓	↓																							
	Green	Gs255	0	0	0	0	0	0	0	0	X	X	1	1	1	1	1	1	0	0	0	0	0	0	0
Gray Scale of Blue	Black	GS0	0	0	0	0	0	0	0	0	0	0	0	0	0	0	0	0	0	0	0	0	0	0	
	↑	GS1	0	0	0	0	0	0	0	0	0	0	0	0	0	0	0	0	1	0	0	0	0	0	0
	Darker	GS2	0	0	0	0	0	0	0	0	0	0	0	0	0	0	0	0	0	1	0	0	0	0	0
	↑	↓																							
		↓																							
		GS250	0	0	0	0	0	0	0	0	0	0	0	0	0	0	0	0	0	1	0	1	1	1	1
	↓	GS251	0	0	0	0	0	0	0	0	0	0	0	0	0	0	0	0	1	1	0	1	1	1	1
	Brighter	GS252	0	0	0	0	0	0	0	0	0	0	0	0	0	0	0	0	X	X	1	1	1	1	1
	↓	↓																							
	Blue	GS255	0	0	0	0	0	0	0	0	0	0	0	0	0	0	0	0	X	X	1	1	1	1	1

0 : Low level voltage, 1 : High level voltage. X :Don't care(GS252 ~ GS255 are same grayscale)

Each basic color can be displayed in 253 gray scales from 8 bit data signals. According to the combination of total 24 bit data signals, the 16-million-color display can be achieved on the screen.

9. Optical Characteristics

Ta=+25 , Vcc=+3.3V

Parameter		Symbol	Condition	Min.	Typ.	Max.	Unit	Remark	
Viewing angle range	Horizontal	21, 22	CR>10	-	65	-	Deg.	[Note 1,3,6]	
	Vertical	11		-	50	-	Deg.		
		12		-	60	-	Deg.		
Contrast ratio		CRn	=0 °	300	-	-		[Note 2,4,6]	
Response time		r+ d	=0 °	-	35	40	ms	[Note 2,5,6]	
Chromaticity of white		x		0.252	0.302	0.352		[Note 2,6]	
		y		0.279	0.329	0.379			
Chromaticity of red		x		0.533	0.583	0.633			
		y		0.272	0.322	0.372			
Chromaticity of green		x		0.274	0.324	0.374			
		y		0.498	0.548	0.598			
Chromaticity of blue		x		0.103	0.153	0.203			
		y		0.048	0.098	0.148			
Luminance of white		Y _{L1}			280	350	-		cd/m ²

The measurement shall be executed 30 minutes after lighting at rating. Condition : (I_f=20mA)

The optical characteristics shall be measured in a dark room or equivalent.

[Note 1] Measuring Viewing Angle Range

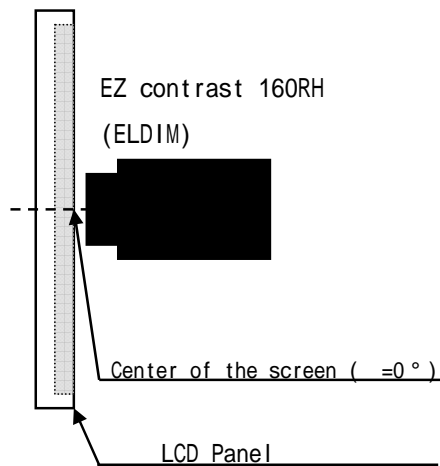

[Note 2] Other Measurements

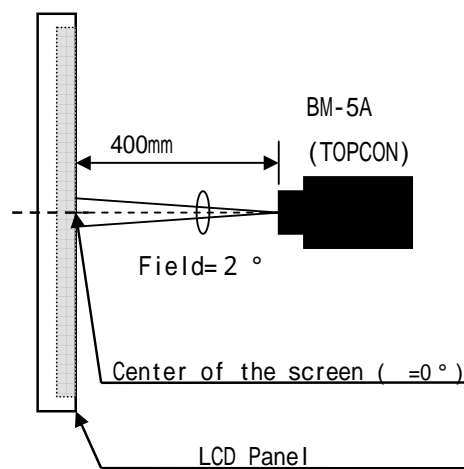

[Note 3] Definitions of viewing angle range:

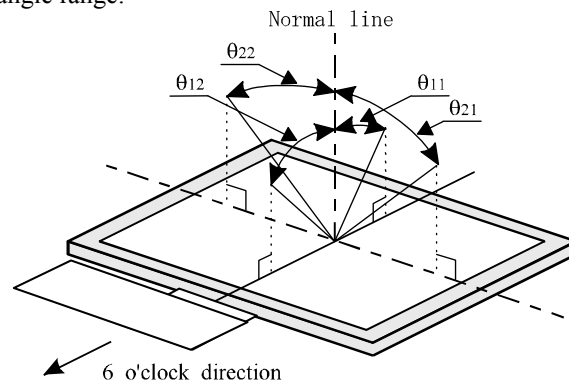

[Note 4] Definition of contrast ratio:

The contrast ratio is defined as the following.

$$\text{Contrast Ratio (CR)} = \frac{\text{Luminance (brightness) with all pixels white}}{\text{Luminance (brightness) with all pixels black}}$$

[Note 5] Definition of response time:

The response time is defined as the following figure and shall be measured by switching the input signal for "black" and "white".

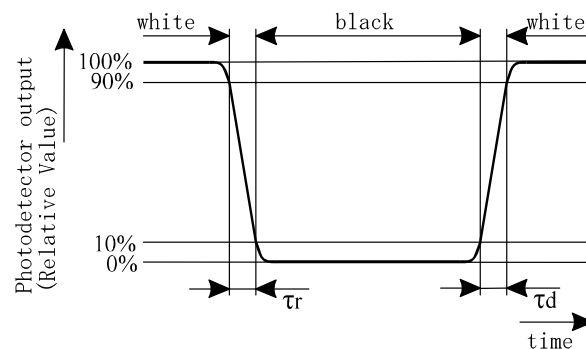

[Note 6] This shall be measured at center of the screen.

10. Display Quality

The display quality of the color TFT-LCD module shall be in compliance with the Incoming Inspection Standard.

11. Handling Precautions

- a) Be sure to turn off the power supply when inserting or disconnecting the cable.

Please insert for too much stress not to join FFC/FPC in the case of insertion of FFC/FPC.

- b) Be sure to design the cabinet so that the module can be installed without any extra stress such as warp or twist.
- c) Since the front polarizer is easily damaged, pay attention not to scratch it.
- d) Wipe off water drop immediately. Long contact with water may cause discoloration or spots.
- e) When the panel surface is soiled, wipe it with absorbent cotton or other soft cloth.
- f) Since the panel is made of glass, it may break or crack if dropped or bumped on hard surface. Handle with care.
- g) Since CMOS LSI is used in this module, take care of static electricity and injure the human earth when handling.
Observe all other precautionary requirements in handling components.
- h) This module has its circuitry PCBs on the rear side and should be handled carefully in order not to be stressed.
- i) Protect sheet(Laminate film) is attached to the module surface to prevent it from being scratched. Peel the sheet off slowly just before the use with strict attention to electrostatic charges. Ionized air shall be blown over during the action. Blow off the 'dust' on the polarizer by using an ionized nitrogen gun, etc. Working under the following environments is desirable.

- All workers wear conductive shoes, conductive clothes, conductive fingerstalls and grounding belts without fail.
- Use Ionized blower for electrostatic removal, and peel of the protect sheet with a constant speed. (Peeling of it at over 2 seconds)

- j) The polarizer surface on the panel is treated with Anti-Glare for low reflection. In case of attaching protective board over the LCD, be careful about the optical interface fringe etc. which degrades display quality.
- k) Do not expose the LCD module to a direct sunlight, for a long period of time to protect the module from the ultra violet ray.
- l) When handling LCD modules and assembling them into cabinets, please be noted that long-term storage in the environment of oxidization or deoxidization gas and the use of such materials as reagent, solvent, adhesive, resin, etc. which generate these gasses, may cause corrosion and discoloration of the LCD modules.
- m) Liquid crystal contained in the panel may leak if the LCD is broken. Rinse it as soon as possible if it gets inside your eye or mouth by mistake.
- n) Disassembling the module can cause permanent damage and should be strictly avoided.
Please don't remove the fixed tape, insulating tape etc that was pasted on the original module.
(Except for protection film of the panel.)
- o) Be careful when using it for long time with fixed pattern display as it may cause afterimage.
(Please use a screen saver etc., in order to avoid an afterimage.)
- p) Adjusting volume have been set optimally before shipment, so do not change any adjusted value. If adjusted value is changed, the specification may not be satisfied.
- q) If a minute particle enters in the module and adheres to an optical material, it may cause display non-uniformity

issue, etc. Therefore, fine-pitch filters have to be installed to cooling and inhalation hole if you intend to install a fan.

- r) Epoxy resin (amine series curing agent), silicone adhesive material (dealcoholization series and oxime series), tray forming agent (azo compound) etc, in the cabinet or the packing materials may induce abnormal display with polarizer film deterioration regardless of contact or noncontact to polarizer film.

Be sure to confirm the component of them.

- s) Do not use polychloroprene. If you use it, there is some possibility of generating Cl_2 gas that influences the reliability of the connection between LCD panel and driver IC.
- t) Do not put a laminate film on LCD module, after peeling of the original one. If you put on it, because of the occurrence of air gaps between the polarizer and the film, It may cause discoloration or spots.

12. Packing form

Piling number of cartons	Max.8
Package quantity in one carton	40pcs
Carton size	380 (W) × 575(D) × 225(H) mm
Total mass of one carton filled with full modules	10 kg
Packing form	Fig.2

13. Reliability Test Items

No.	Test item	Conditions
1	High temperature operation test	Ta = +50 240h
2	Low temperature operation test	Ta = -20 240h
3	High temperature storage test	Ta = +70 240h
4	Low temperature storage test	Ta = -30 240h
5	High temperature & high humidity operation test	Ta = +40 ; 95 %RH 240h (No condensation)
6	Vibration test (non- operating)	Frequency range: 10 to 55Hz Sweep: 1.5mm Sweep time: 1minute Test period: 2 hours for each direction of X,Y,Z
7	Shock test	Direction: ±X, ±Y, ±Z, Time: 3 times for each direction. Impact value: 980m/s ² , Action time 6ms

[Result Evaluation Criteria]

Under the display quality test conditions with normal operation state, these shall be no change which may affect practical display function. (normal operation state : Temperature:15 ~ 35 ,

Humidity:45 ~ 75%, Atmospheric pressure:86 ~ 106kpa)

14. Label

1) Module label:

Notation: Model No. Serial No.

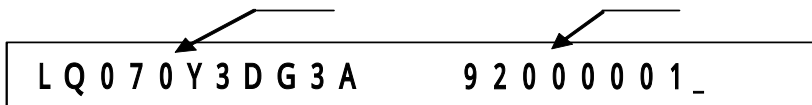

Details of Serial No

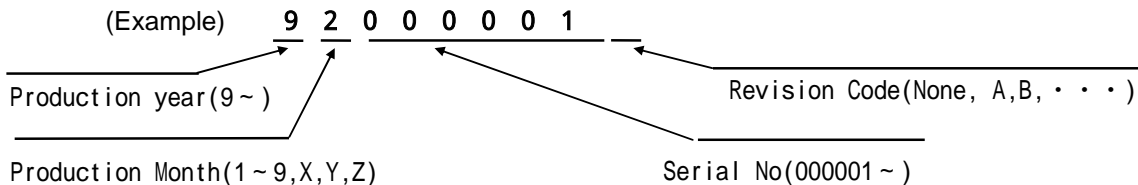

[Note] Production year : 9(2009)、0(2010)、1(2011)、

Production Month : 1(Jan)、2(Feb)、 . . . 、9(Sep)、X(Oct)、Y(Nov)、Z(Dec)

2) Packing bar code label

Notation/ Bar code: Model No. Date Quantity

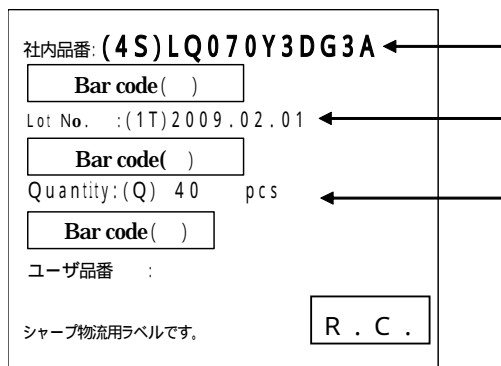

R.C. (RoHS Compliance) means these parts have corresponded with the RoHS directive.

15. Storage conditions

<Environmental condition range of storage temperature and humidity>

Temperature 0 to 40 degrees Celsius

Relative humidity 70% and below

Direct sun light

Please keep the product in a dark room or cover the product to protect from direct sun light.

Atmospheric condition

Please refrain from keeping the product with possible corrosive gas or volatile flux.

Prevention of dew

* Please store the product carton either on a wooden pallet or a stand / rak to prevent dew.

Do not place directly on the floor. In addition, to obtain moderate ventilation in between the pallet's top and bottom surfaces, pile the cartons up in a single direction and in order.

* Please place the product cartons away from the strage wall.

* Please maintain the storage area with an appropriate ventilation. It is recommendable to furnish the storage area with equipments such as ventilation systems.

* Please maintain the ambient temperature within the range of natural environmental fluctuation.

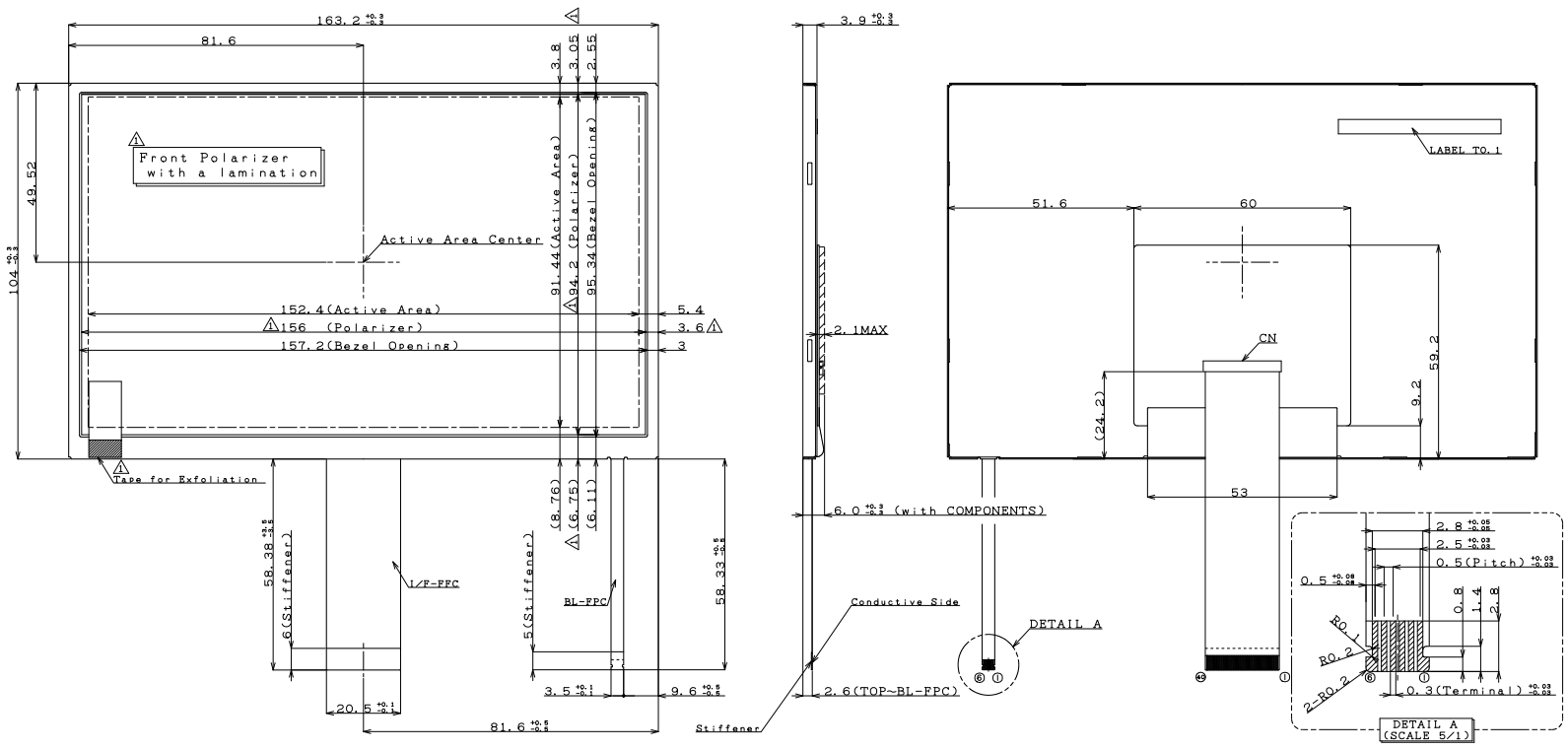

Fig LQ070Y3DG3A OUTLINE DIMENSIONS

NOTES
 1. UNSPECIFIED TOLERANCE TO BE ± 0.5
 2. WARP AND FLATTING FOR PCB AND CHASSIS ARE EXCLUDED FROM THICKNESS AND DIMENSION OF THE UNIT.

D/N: 2D-085-040-07

LCD Specification

LCD Group



NORTH AMERICA

Sharp Microelectronics of the Americas
5700 NW Pacific Rim Blvd.
Camas, WA 98607, U.S.A.
Phone: (1) 360-834-2500
Fax: (1) 360-834-8903
www.sharpsma.com

TAIWAN

Sharp Electronic Components
(Taiwan) Corporation
8F-A, No. 16, Sec. 4, Nanking E. Rd.
Taipei, Taiwan, Republic of China
Phone: (886) 2-2577-7341
Fax: (886) 2-2577-7326/2-2577-7328

CHINA

Sharp Microelectronics of China
(Shanghai) Co., Ltd.
28 Xin Jin Qiao Road King Tower 16F
Pudong Shanghai, 201206 P.R. China
Phone: (86) 21-5854-7710/21-5834-6056
Fax: (86) 21-5854-4340/21-5834-6057
Head Office:
No. 360, Bashen Road,
Xin Development Bldg. 22
Waigaoqiao Free Trade Zone Shanghai
200131 P.R. China
Email: smc@china.global.sharp.co.jp

EUROPE

Sharp Microelectronics Europe
Division of Sharp Electronics (Europe) GmbH
Sonninstrasse 3
20097 Hamburg, Germany
Phone: (49) 40-2376-2286
Fax: (49) 40-2376-2232
www.sharpsme.com

SINGAPORE

Sharp Electronics (Singapore) PTE., Ltd.
438A, Alexandra Road, #05-01/02
Alexandra Technopark,
Singapore 119967
Phone: (65) 271-3566
Fax: (65) 271-3855

KOREA

Sharp Electronic Components
(Korea) Corporation
RM 501 Geosung B/D, 541
Dohwa-dong, Mapo-ku
Seoul 121-701, Korea
Phone: (82) 2-711-5813 ~ 8
Fax: (82) 2-711-5819

JAPAN

Sharp Corporation
Electronic Components & Devices
22-22 Nagaïke-cho, Abeno-Ku
Osaka 545-8522, Japan
Phone: (81) 6-6621-1221
Fax: (81) 6117-725300/6117-725301
www.sharp-world.com

HONG KONG

Sharp-Roxy (Hong Kong) Ltd.
3rd Business Division,
17/F, Admiralty Centre, Tower 1
18 Harcourt Road, Hong Kong
Phone: (852) 28229311
Fax: (852) 28660779
www.sharp.com.hk
Shenzhen Representative Office:
Room 13B1, Tower C,
Electronics Science & Technology Building
Shen Nan Zhong Road
Shenzhen, P.R. China
Phone: (86) 755-3273731
Fax: (86) 755-3273735

SPECIFICATIONS ARE SUBJECT TO CHANGE WITHOUT NOTICE.

Suggested applications (if any) are for standard use; See Important Restrictions for limitations on special applications. See Limited Warranty for SHARP's product warranty.

The Limited Warranty is in lieu, and exclusive of, all other warranties, express or implied.

ALL EXPRESS AND IMPLIED WARRANTIES, INCLUDING THE WARRANTIES OF MERCHANTABILITY, FITNESS FOR USE AND FITNESS FOR A PARTICULAR PURPOSE, ARE SPECIFICALLY EXCLUDED. In no event will SHARP be liable, or responsible in any way, for any incidental or consequential economic or property damage.