

SHARP

LQ121S1DG31

TFT-LCD Module

(Model Number: LQ121S1DG31)

Specifications

Spec No.: LD-12204A

Dated: June 10, 2002

PREPARED BY : DATE	<h1>SHARP</h1> <p>TFT Liquid Crystal Display Group SHARP CORPORATION</p> <h2>SPECIFICATION</h2>	SPEC No. LD-12204A
		FILE No.
APPROVED BY : DATE		ISSUE : Feb. 7. 2000
		PAGE : 16 pages
		APPLICABLE GROUP TFT Liquid Crystal Display Group

DEVICE SPECIFICATION FOR

TFT-LCD Module

MODEL No.

LQ121S1DG31

CUSTOMER'S APPROVAL

DATE _____

BY _____

PRESENTED

BY _____

M. TAKEDA
 Department General Manager
 Development Engineering Dept. II
 TFT Division. II
 TFT LIQUID CRYSTAL DISPLAY GROUP
 SHARP CORPORATION

1. Application

This technical literature applies to color TFT-LCD module, LQ121S1DG31.

These specification sheets are the proprietary product of SHARP CORPORATION ("SHARP") and include materials protected under copyright of SHARP. Do not reproduce or cause any third party to reproduce them in any form or by any means, electronic or mechanical, for any purpose in whole or in part, without the express written permission of SHARP.

The device listed in these technical literature sheets was designed and manufactured for use in general electronic equipment.

In case of using the device for applications such as control and safety equipment for transportation(aircraft, trains, automobiles, etc.),rescue and security equipment and various safety related equipment which require higher reliability and safety, take into consideration that appropriate measures such as fail-safe functions and redundant system design should be taken.

Do not use the device for equipment that requires an extreme level of reliability, such as aerospace applications, telecommunication equipment(trunk lines), nuclear power control equipment and medical or other equipment for life support.

SHARP assumes no responsibility for any damage resulting from the use of the device which does not comply with the instructions and the precautions specified in these specification sheets.

Contact and consult with a SHARP sales representative for any questions about this device.

2. Overview

This module is a color active matrix LCD module incorporating amorphous silicon TFT (Thin Film Transistor). It is composed of a color TFT-LCD panel, driver ICs, control circuit and power supply circuit and a backlight unit. Graphics and texts can be displayed on a $800 \times 3 \times 600$ dots panel with 262,144 colors by supplying 18 bit data signal (6bit/color), four timing signals, +3.3V/5V DC supply voltage for TFT-LCD panel driving and supply voltage for backlight.

The TFT-LCD panel used for this module is a low-reflection and higher-color-saturation type.

Therefore, this module is also suitable for the multimedia use. Viewing angle is 6 o'clock direction.

This module is the type of wide viewing angle and high brightness(300cd/m²).

Backlight-driving DC/AC inverter is not built in this module.

3. Mechanical technical literature.

Parameter	Specifications	Unit
Display size	31 (12.1") Diagonal	cm
Active area	246.0(H)×184.5(V)	mm
Pixel format	800(H)×600(V)	pixel
	(1 pixel=R+G+B dots)	—
Pixel pitch	0.3075(H)×0.3075(V)	mm
Pixel configuration	R,G,B vertical stripe	—
Display mode	Normally white	—
Unit outline dimensions *1	276.0(W)×209.0(H)×14.0(D)	mm
Mass	775±25	g
Surface treatment	Anti-glare and hard-coating 3H Haze value = 28 %	—

*1.Note: excluding backlight cables.

Outline dimensions is shown in Fig.1

4. Input Terminals

4-1. TFT-LCD panel driving

CN1 Used connector:DF9MA-41P-1V (Hirose Electric Co., Ltd.)

Corresponding connector: DF9-41S-1V,DF9A-41S-1V,DF9B-41S-1V,DF9M-41S-1V

Pin No.	Symbol	Function	Remark
1	GND	—	—
2	CK	Clock signal for sampling each data signal	—
3	GND	—	—
4	Hsync	Horizontal synchronous signal	【Note1】
5	Vsync	Vertical synchronous signal	【Note1】
6	GND	—	—
7	GND	—	—
8	GND	—	—
9	R0	R E D data signal(LSB)	—
10	R1	R E D data signal	—
11	R2	R E D data signal	—
12	GND	—	—
13	R3	R E D data signal	—
14	R4	R E D data signal	—
15	R5	R E D data signal(MSB)	—
16	GND	—	—
17	GND	—	—
18	GND	—	—
19	G0	G R E E N data signal(LSB)	—
20	G1	G R E E N data signal	—
21	G2	G R E E N data signal	—
22	GND	—	—
23	G3	G R E E N data signal	—
24	G4	G R E E N data signal	—
25	G5	G R E E N data signal(MSB)	—
26	GND	—	—
27	GND	—	—
28	GND	—	—
29	B0	B L U E data signal(LSB)	—
30	B1	B L U E data signal	—
31	B2	B L U E data signal	—
32	GND	—	—
33	B3	B L U E data signal	—
34	B4	B L U E data signal	—
35	B5	B L U E data signal(MSB)	—
36	GND	—	—
37	ENAB	Signal to settle the horizontal display position	【Note2】
38	NC	—	—
39	Vcc	power supply	—
40	Vcc	power supply	—
41	NC	—	—

※The shielding case is connected with GND.

【Note1】 The polarity of both synchronous signals are negative.

【Note2】 The horizontal display start timing is settled in accordance with a rising timing of ENAB signal. In case ENAB is fixed "Low", the horizontal start timing is determined as described in 7-2. Don't keep ENAB "High" during operation.

4-2. Backlight driving

Used connector : BHR-03VS-1(JST)

CN 2 , CN3 Corresponding connector :SM02(8.0)B-BHS(JST)

Pin no.	symbol	function
1	VHIGH	Power supply for lamp (High voltage side)
2	NC	This is electrically opened.
3	VLOW	Power supply for lamp (Low voltage side)

5. Absolute Maximum Ratings

Parameter	Symbol	Condition	Ratings	Unit	Remark
Input voltage	V_I	$T_a=25^\circ\text{C}$	$-0.3 \sim V_{cc}+0.3$	V	【Note1】
supply voltage	V_{cc}	$T_a=25^\circ\text{C}$	$0 \sim +6$	V	—
Storage temperature	T_{stg}	—	$-25 \sim +60$	$^\circ\text{C}$	【Note2】
Operating temperature (Ambient)	T_{opa}	—	$0 \sim +50$	$^\circ\text{C}$	

【Note1】 CK,R0~R5,G0~G5,B0~B5,Hsync,Vsync,ENAB

【Note2】 Humidity : 95%RH Max. at $T_a \leq 40^\circ\text{C}$.

Maximum wet-bulb temperature at 39°C or less at $T_a > 40^\circ\text{C}$.

No condensation.

6. Electrical Characteristics

6-1. TFT-LCD panel driving

Ta=25°C

Parameter		Symbol	Min.	Typ.	Max.	Unit	Remark
Power Supply	Supply voltage	V _{CC}	+3.0	+3.3 +5.0	+5.5	V	【Note1】
	Current dissipation	I _{CC}	—	175	250	mA	V _F =3.3V 【Note2】
I _{CC}		—	160	240	mA	V _F =5.0V 【Note2】	
Permissive input ripple voltage		V _{RF}	—	—	100	mVp-p	
Input voltage (Low)		V _{IL}	—	—	0.9	V	【Note3】
Input voltage (High)		V _{IH}	2.5	—	—	V	
Input current (low)		I _{OL}	—	—	1.0	μA	V _F =0V 【Note4】
Input current (High)		I _{OH}	—	—	1.0	μA	V _F =V _{CC} 【Note5】
Input current (low)		I _{OL}	—	—	3.0	μA	V _F =0V 【Note6】
Input current (High)		I _{OH}	—	—	100	μA	V _F =V _{CC} 【Note6】

【Note1】

V_{CC}-turn-on conditions

- 0 < t₁ ≤ 10ms
- 0 < t₂ ≤ 20ms
- 0 < t₃ ≤ 1s
- t₄ > 1s

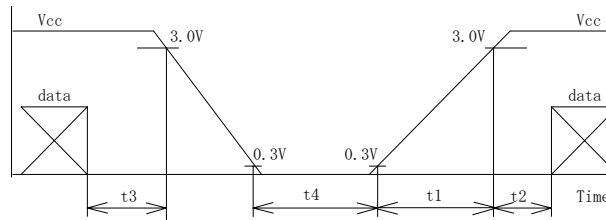

V_{CC}-dip conditions

- 1) 2.4V ≤ V_{CC} < 3.0V
t_d ≤ 10ms
- 2) V_{CC} < 2.4V

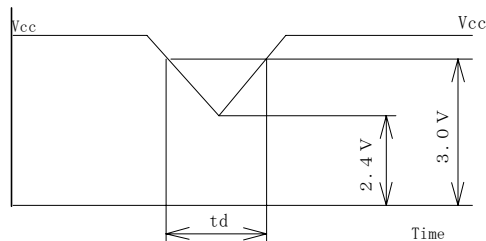

V_{CC}-dip conditions should also follow

the V_{CC}-turn-on conditions

【Note2】 Typical current situation : 16-gray-bar pattern.

【Note3】 CK,R0~R5,G0~G5,B0~B5,Hsync,Vsync,ENAB

【Note4】 CK,R0~R5,G0~G5,B0~B5,Hsync,Vsync

【Note5】 CK,R0~R5,G0~G5,B0~B5,Hsync,Vsync

【Note6】 ENAB

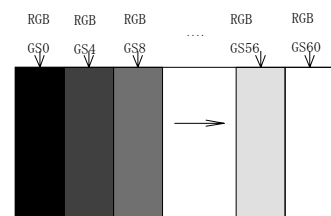

6-2. Backlight driving

The backlight system is an edge-lighting type with double CCFT (Cold Cathode Fluorescent Tube).

The characteristics of single lamp are shown in the following table. Ta=25°C

Parameter	Symbol	Min.	Typ.	Max.	Unit	Remark
Lamp current	I_L	2.0	6.0	6.0	mA rms	【Note1】
Lamp power consumption	P_L	—	3.3	—	W	【Note2】
Lamp frequency	F_L	35	60	80	KHz	【Note3】
Kick-off voltage	V_s	—	—	1200	V rms	Ta=25°C 【Note4】
		—	—	1400	V rms	Ta=0°C 【Note4】
Lamp life time	L_L	—	50000	—	Hour	【Note5】

【Note1】 Lamp current is measured with current meter for high frequency as shown below.

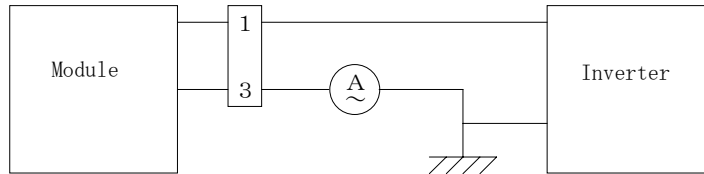

* 3pin is V_{LOW}

【Note2】 At the condition of $Y_L = 300\text{cd/m}^2$

【Note3】 Lamp frequency may produce interference with horizontal synchronous frequency, and this may cause beat on the display. Therefore lamp frequency shall be detached as much as possible from the horizontal synchronous frequency and from the harmonics of horizontal synchronous to avoid interference.

【Note4】 The open output voltage of the inverter shall be maintained for more than 1s; otherwise the lamp may not be turned on.

【Note5】 a) Since lamp is consumables, the life time written above is referential value and it is not guaranteed in this specification sheet by SHARP.

Lamp life time is defined that it applied either ① or ② under this condition

(Continuous turning on at Ta=25°C, $I_L = 6\text{mA rms}$)

① Brightness becomes 50% of the original value under standard condition.

② Kick-off voltage at Ta=0°C exceeds maximum value, (1400V) rms.

b) In case of operating under lower temp environment, the lamp exhaustion is accelerated and the brightness becomes lower.

(Continuous operating for around 1 month under lower temp condition may reduce the brightness to half of the original brightness.)

In case of such usage under lower temp environment, periodical lamp exchange is recommended.

【Note6】 The performance of the backlight, for example life time or brightness, is much influenced by the characteristics of the DC-AC inverter for the lamp. When you design or order the inverter, please make sure that a poor lighting caused by the mismatch of the backlight and the inverter (miss-lighting, flicker, etc.) never occur. when you confirm it, the module should be operated in the same condition as it is installed in your instrument.

Be sure to use a back light power supply with the safety protection circuit such as the detection circuit for the excess voltage, excess current and or electric discharge waveform.

Be sure to use the detect circuit by which one side of the CCFT lamps can be controlled

independently. Otherwise, when one side of the CCFT is open, the excess current may possibly be applied to the other side of the lamp.

【Note7】 It is required to have the inverter designed so that to allow the impedance deviation of the two CCFT lamps and the capacity deviation of barast capacitor.

7. Timing Characteristics of input signals

Timing diagrams of input signal are shown in Fig.2.

7-1. Timing characteristics

Parameter		Symbol	Min.	Typ.	Max.	Unit	Remark
Clock	Frequency	1/Tc	—	40.0	42.0	MHz	—
	High time	Tch	6	—	—	ns	—
	Low time	Tcl	6	—	—	ns	—
	Duty ratio	Th/T	40	50	60	%	—
Data	Setup time	Tds	3	—	—	ns	—
	Hold time	Tdh	5	—	—	ns	—
Horizontal sync. signal	Cycle	TH	20.8	26.4	—	μs	—
			832	1056	—	clock	—
	Pulse width	THp	2	128	200	clock	—
Vertical sync. signal	Cycle	TV	628	666	798	line	—
	Pulse width	TVp	2	4	6	line	—
Horizontal display period		THd	800	800	800	clock	—
Hsync-Clock phase difference		THc	0	—	Tc-10	ns	—
Hsync-Vsync phase difference		TVh	0	—	TH-THp	ns	—
Vertical data start position		TVs	23	23	23	line	—

Note) In case of lower frequency, the deterioration of display quality, flicker etc., may be occurred.

7-2. Horizontal display position

The horizontal display position is determined by ENAB signal and the input data corresponding to the rising edge of ENAB signal is displayed at the left end of the active area.

Parameter		symbol	Min.	Typ.	Max.	Unit	Remark
Enable signal	Setup time	Tes	5	—	Tc-10	ns	—
	Pulse width	Tep	2	800	TH-10	clock	—
Hsync-Enable signal phase difference		THE	58	88	170	clock	—

Note) When ENAB is fixed "Low", the display starts from the data of C88(clock) as shown in Fig.2.

7-3. Vertical display position

The vertical display position, TVs is fixed "23" (line).

7-4. Input Data Signals and Display Position on the screen

Display position of input data

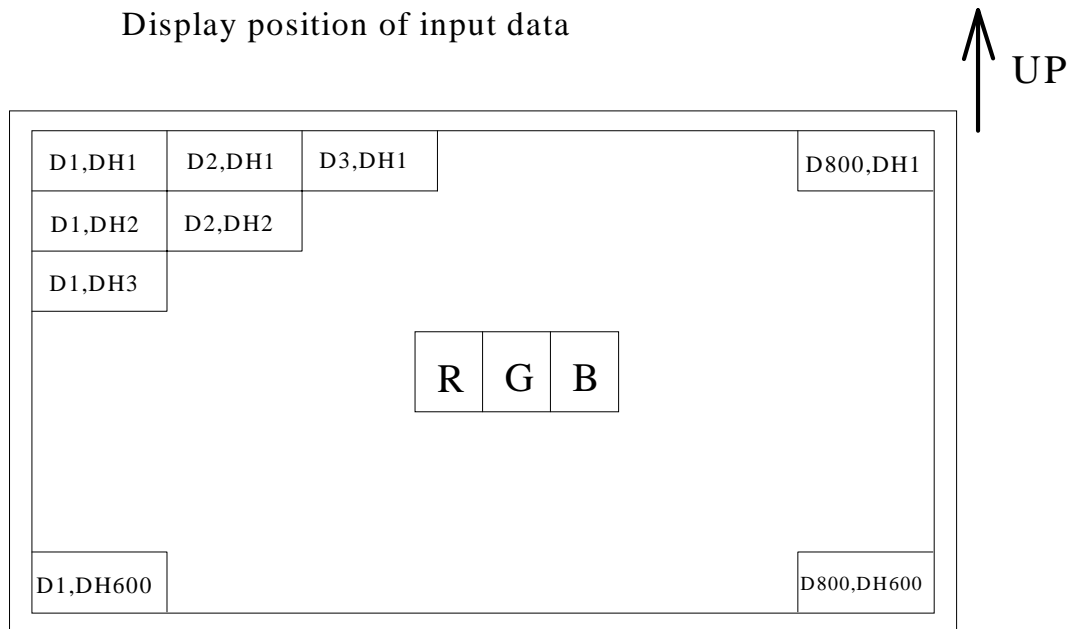

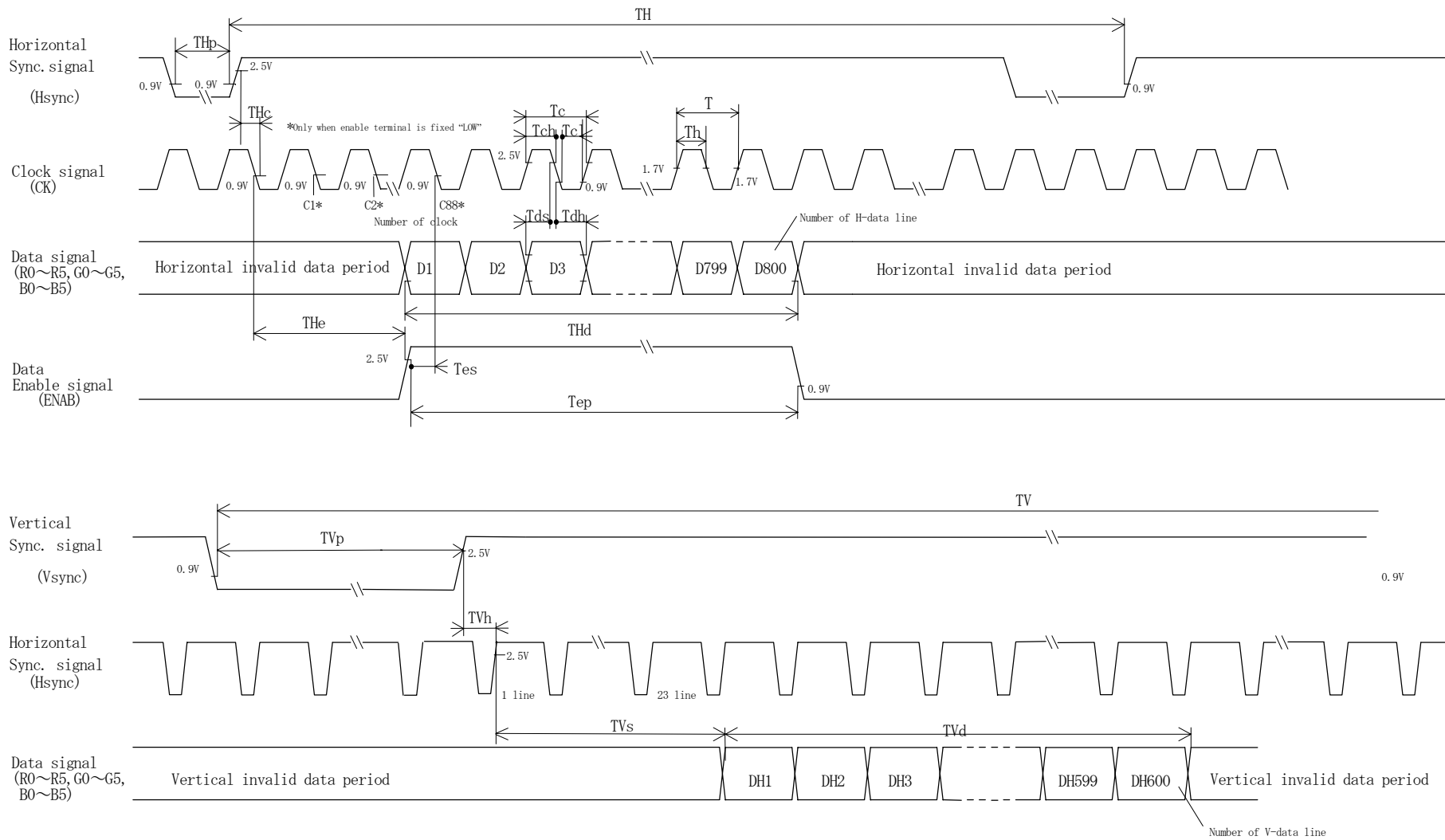

Fig. 2 Input signal waveforms

8. Input Signals, Basic Display Colors and Gray Scale of Each Color

	Colors & Gray scale	Data signal																		
		GrayScale	R0	R1	R2	R3	R4	R5	G0	G1	G2	G3	G4	G5	B0	B1	B2	B3	B4	B5
Basic color	Black	—	0	0	0	0	0	0	0	0	0	0	0	0	0	0	0	0	0	0
	Blue	—	0	0	0	0	0	0	0	0	0	0	0	0	1	1	1	1	1	1
	Green	—	0	0	0	0	0	0	1	1	1	1	1	1	0	0	0	0	0	0
	Cyan	—	0	0	0	0	0	0	1	1	1	1	1	1	1	1	1	1	1	1
	Red	—	1	1	1	1	1	1	0	0	0	0	0	0	0	0	0	0	0	0
	Magenta	—	1	1	1	1	1	1	0	0	0	0	0	0	1	1	1	1	1	1
	Yellow	—	1	1	1	1	1	1	1	1	1	1	1	1	0	0	0	0	0	0
	White	—	1	1	1	1	1	1	1	1	1	1	1	1	1	1	1	1	1	1
Gray Scale of Red	Black	GS0	0	0	0	0	0	0	0	0	0	0	0	0	0	0	0	0	0	0
	↑	GS1	1	0	0	0	0	0	0	0	0	0	0	0	0	0	0	0	0	0
	Darker	GS2	0	1	0	0	0	0	0	0	0	0	0	0	0	0	0	0	0	0
	↑	↓				↓				↓							↓			
	↓	↓				↓				↓							↓			
	Brighter	GS61	1	0	1	1	1	1	0	0	0	0	0	0	0	0	0	0	0	0
	↓	GS62	0	1	1	1	1	1	0	0	0	0	0	0	0	0	0	0	0	0
	Red	GS63	1	1	1	1	1	1	0	0	0	0	0	0	0	0	0	0	0	0
Gray Scale of Green	Black	GS0	0	0	0	0	0	0	0	0	0	0	0	0	0	0	0	0	0	0
	↑	GS1	0	0	0	0	0	0	1	0	0	0	0	0	0	0	0	0	0	0
	Darker	GS2	0	0	0	0	0	0	0	1	0	0	0	0	0	0	0	0	0	0
	↑	↓				↓				↓							↓			
	↓	↓				↓				↓							↓			
	Brighter	GS61	0	0	0	0	0	0	1	0	1	1	1	1	0	0	0	0	0	0
	↓	GS62	0	0	0	0	0	0	0	1	1	1	1	1	0	0	0	0	0	0
	Green	GS63	0	0	0	0	0	0	1	1	1	1	1	1	0	0	0	0	0	0
Gray Scale of Blue	Black	GS0	0	0	0	0	0	0	0	0	0	0	0	0	0	0	0	0	0	0
	↑	GS1	0	0	0	0	0	0	0	0	0	0	0	1	0	0	0	0	0	0
	Darker	GS2	0	0	0	0	0	0	0	0	0	0	0	0	0	1	0	0	0	0
	↑	↓				↓				↓							↓			
	↓	↓				↓				↓							↓			
	Brighter	GS61	0	0	0	0	0	0	0	0	0	0	0	1	0	1	1	1	1	1
	↓	GS62	0	0	0	0	0	0	0	0	0	0	0	0	1	1	1	1	1	1
	Blue	GS63	0	0	0	0	0	0	0	0	0	0	0	1	1	1	1	1	1	1

0 : Low level voltage, 1 : High level voltage

Each basic color can be displayed in 64 gray scales from 6 bit data signals. According to the combination of total 18 bit data signals, the 262,144-color display can be achieved on the screen.

9. Optical Characteristics

Ta=25°C, Vcc=+3.3V

Parameter		Symbol	Condition	Min.	Typ.	Max.	Unit	Remark
Viewing angle	Horizontal	θ_{21}, θ_{22}	$(CR \geq 5)$	60	—	—	Deg.	【Note1,4】
	Vertical	θ_{11}		45	—	—	Deg.	
		θ_{12}		50	—	—	Deg.	
Viewing angle	Horizontal	θ_{21}, θ_{22}	$(CR \geq 10)$	50	60	—	Deg.	【Note1,4】
	Vertical	θ_{11}		35	45	—	Deg.	
		θ_{12}		45	55	—	Deg.	
Contrast ratio		CRn	$\theta = 0^\circ$	150	—	—	—	【Note2,4】
		CRo	Best viewing angle	—	300	—	—	—
Response time	Rise	τ_r	$\theta = 0^\circ$	—	15	—	ms	【Note3,4】
	Decay	τ_d		—	30	—	ms	
Chromaticity of White		X		—	0.313	—	—	【Note4】
		Y		—	0.329	—	—	
Luminance of white		YL		240	300	—	cd/m ²	
White Uniformity		δ_w		—	—	1.45	—	【Note5】

※The measurement shall be executed 30 minutes after lighting at rating. (typical condition:IL=6mA rms)

The optical characteristics shall be measured in a dark room or equivalent state with the method shown in Fig.3 below.

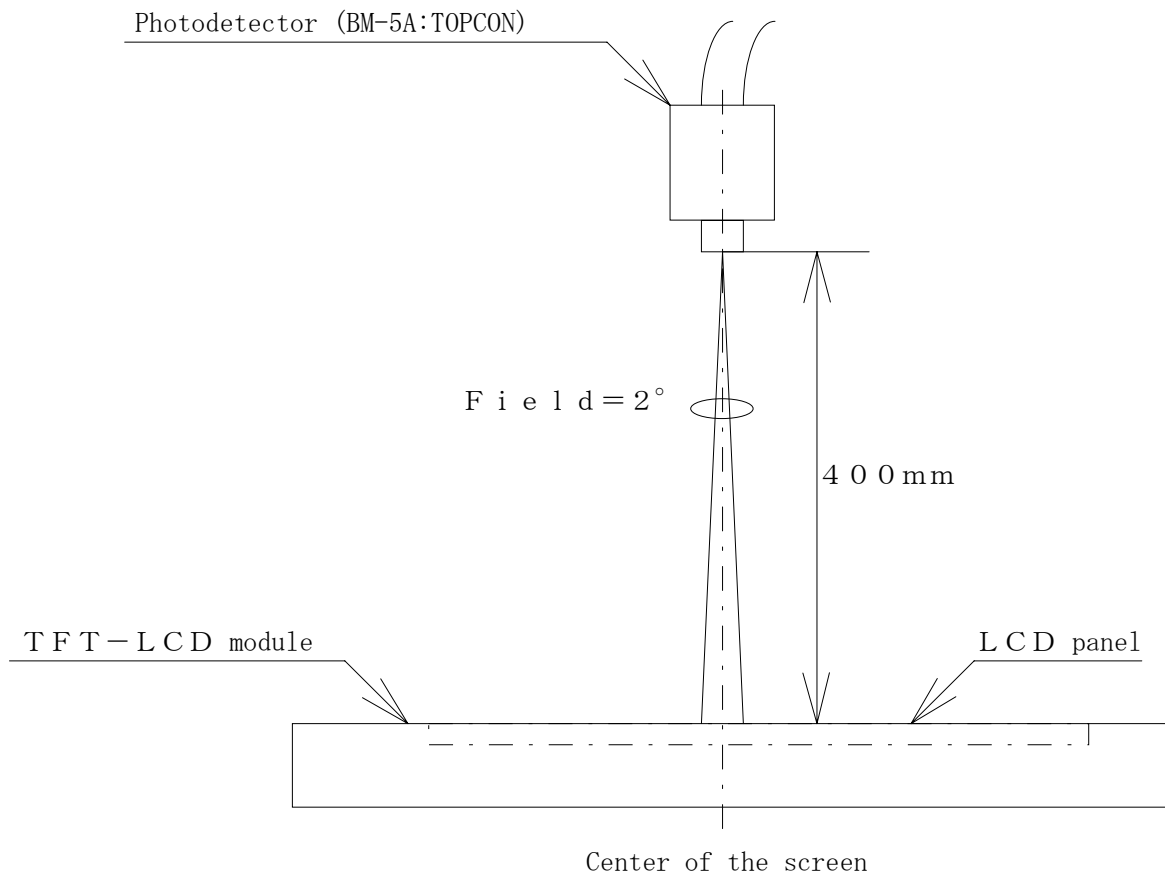
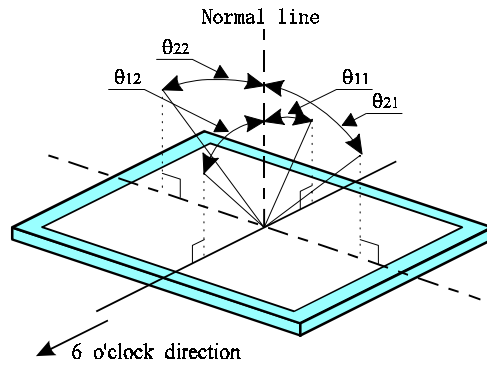

Fig. 3 Optical characteristics measurement method

【Note1】 Definitions of viewing angle range:



【Note2】 Definition of contrast ratio:

The contrast ratio is defined as the following.

$$\text{Contrast Ratio (CR)} = \frac{\text{Luminance (brightness) with all pixels white}}{\text{Luminance (brightness) with all pixels black}}$$

【Note3】 Definition of response time:

The response time is defined as the following figure and shall be measured by switching the input signal for "black" and "white".

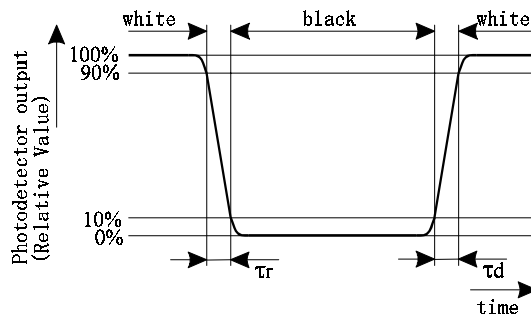

【Note4】 This shall be measured at center of the screen.

【Note5】 Definition of white uniformity:

White uniformity is defined as the following with five measurements (A~E).

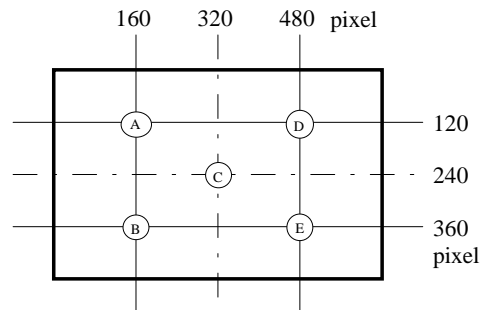

$$\delta_w = \frac{\text{Maximum Luminance of five points (brightness)}}{\text{Minimum Luminance of five points (brightness)}}$$

10. Display Quality

The display quality of the color TFT-LCD module shall be in compliance with the Incoming Inspection Standard.

11. Handling Precautions

- a) Be sure to turn off the power supply when inserting or disconnecting the cable.
- b) Be sure to design the cabinet so that the module can be installed without any extra stress such as warp or twist.

To avoid excessive stress on the circuit board, press the surface of the metal case of LCD module, while inserting the connector.

- c) Since the front polarizer is easily damaged, pay attention to avoid rubbing with something hard or sharp.
- d) Wipe off water drop immediately. Long contact with water may cause discoloration or spots.
- e) When the panel surface is soiled, wipe it with absorbent cotton or other soft cloth.
- f) Since the panel is made of glass and refined wires and components, it may break, crack or internal wire breaking if dropped or bumped on hard surface.
Handle with care.
- g) Since CMOS LSI is used in this module, take care of static electricity and injure the human earth when handling.
- h) Observe all other precautionary requirements in handling components.
- i) This module has its circuitry PCBs on the rear side and should be carefully handled in order not to be stressed.
- j) The polarizer surface on the panel is treated with Anti-Glare for low reflection. In case of attaching protective board over the LCD. Be careful about the optical interference fringe etc.
Which degrades display quality.
- k) Connect GND to 4 place of mounting holes to stabilize against EMI and external noise.
- l) There are high voltage portions on the backlight and very dangerous. Careless touch may lead to electrical shock. When exchange lamps or service. Turn off the power without fail.

12. Packing form

- a) Piling number of cartons : MAX.: 8
- b) Package quantity in one carton : 10 pcs
- c) Carton size : 359 mm(W) × 266 mm(H) × 292 mm(D)
- d) Total mass of 1 carton filled with full modules : 9.1 (kg)

13. Reliability test items

No.	Test item	Conditions
1	High temperature storage test	Ta=60°C 240h
2	Low temperature storage test	Ta=-25°C 240h
3	High temperature & high humidity operation test	Ta=40°C ; 95%RH 240h (No condensation)
4	High temperature operation test	Ta=50°C 240h
5	Low temperature operation test	Ta=0°C 240h
6	Vibration test (non- operating)	Frequency : 10~57Hz/Vibration width (one side):0.075mm : 58~500Hz/Gravity:9.8m/s ² Sweep time : 11 minutes Test period : 3 hours (1 hour for each direction of X,Y,Z)
7	Shock test (non- operating)	Max. gravity : 490m/s ² Pulse width : 11ms, half sine wave Direction : ±X, ±Y, ±Z once for each direction.

【Result Evaluation Criteria】

Under the display quality test conditions with normal operation state, these shall be no change which may affect practical display function.

14. Others

1) Lot No. Label : △ 1

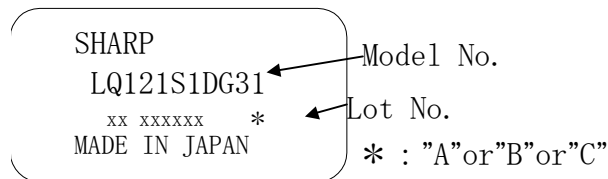

- 2) Adjusting volume have been set optimally before shipment, so do not change any adjusted value.
If adjusted value is changed, the specification may not be satisfied.
- 3) Disassembling the module can cause permanent damage and should be strictly avoided.
- 4) Please be careful since image retention may occur when a fixed pattern is displayed for a long time.

CCFT CONNECTOR

CN2, CN3: BHR-03VS-1 (JST)
PIN LAYOUT

1	High
2	NC
3	GND

NOTES

1. UNSPECIFIED TOLERANCE TO BE ± 0.5
2. WARP AND FLATING FOR PWB COVER, LAMP UNIT AND CHASSIS ARE EXCLUDED FROM THICKNESS AND DIMENSION OF THE UNIT.

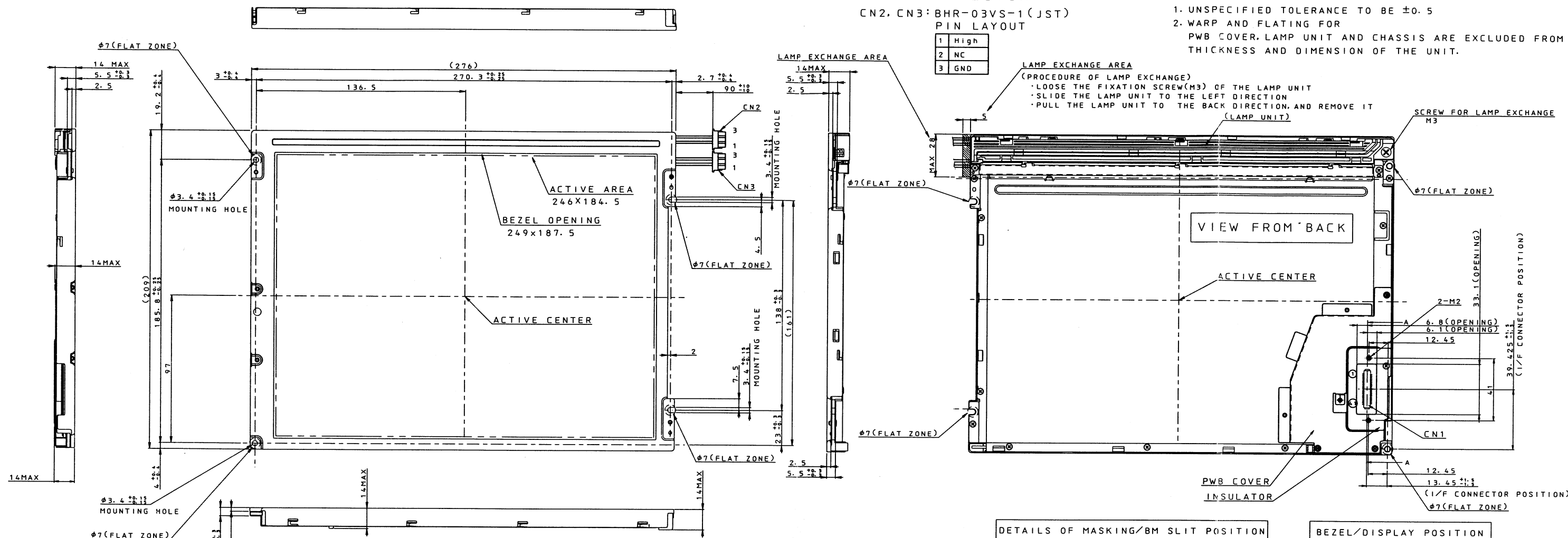

INTERFACE CONNECTOR
CN1: DF9MA-41P-1V(HIROSE)
PIN LAYOUT(41PIN)

pin	1	2	3	4	5	6	7	8	9	10	11	12	13	14	15	
	GND	CK	GND	HS	VS	GND	GND	GND	R0	R1	R2	GND	R3	R4	R5	
16	17	18	19	20	21	22	23	24	25	26	27	28	29	30	31	
	GND	GND	GND	G0	G1	G2	GND	G3	G4	G5	GND	GND	GND	B0	B1	B2
32	33	34	35	36	37	38	39	40	41	42	43	44	45	46	47	
	GND	B3	B4	B5	GND	ENAB	NC	VCC	VCC	NC						
48	49	50	51	52	53	54	55	56	57	58	59	60	*	*	*	

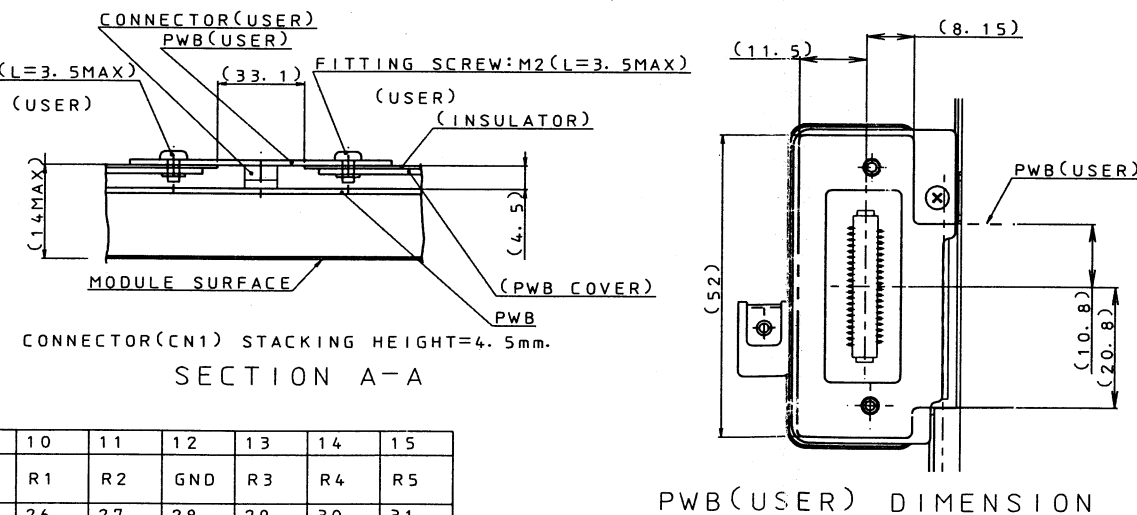

PWB(USER) DIMENSION

DETAILS OF MASKING/BM SLIT POSITION
BEZEL/DISPLAY POSITION

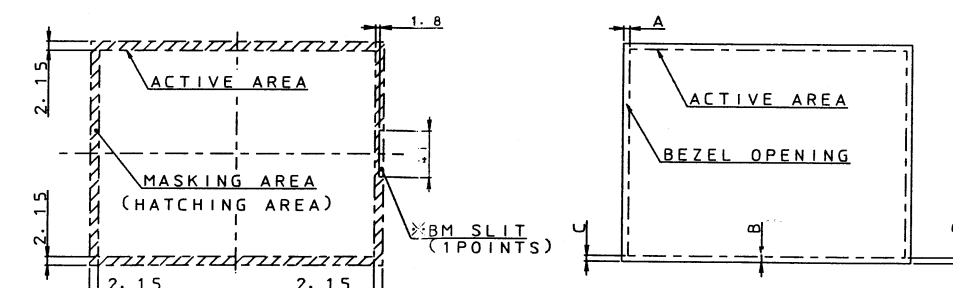

NOTE: THERE IS *BM SLIT AT THE ABOVE MENTIONED POSITION AT THE RIGHT SIDE OF MODULE.
 1) TOLERANCE X-DIRECTION A: 1.5 \pm 0.8
 2) TOLERANCE Y-DIRECTION B: 1.5 \pm 0.8
 3) OBLIQUITY OF DISPLAY AREA |C-D| < 0.8

*BM SLIT: THE POSITION LOOKED DIFFERENT COLOR (LIKE BROWN) AT THE MASKING PORTION. THERE IS NO LIGHT LEAKAGE AT THE SLIT. (BM IS AN ABBREVIATION OF BLACK MASK)

Fig1. OUTLINE DIMENSIONS
(LQ121SIDG31)

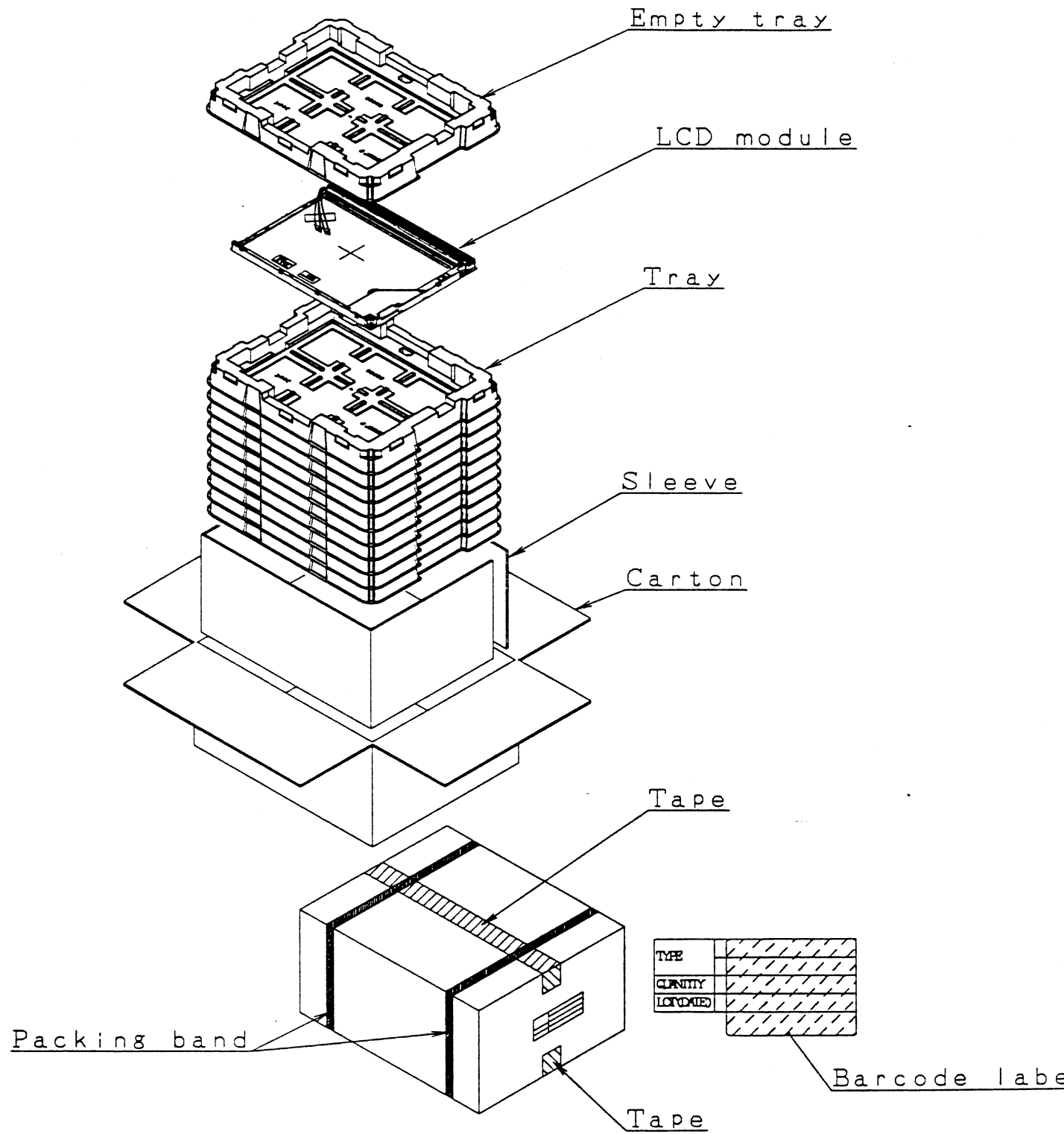

SPECIFICATIONS ARE SUBJECT TO CHANGE WITHOUT NOTICE.

Suggested applications (if any) are for standard use; See Important Restrictions for limitations on special applications. See Limited Warranty for SHARP's product warranty. The Limited Warranty is in lieu, and exclusive of, all other warranties, express or implied. ALL EXPRESS AND IMPLIED WARRANTIES, INCLUDING THE WARRANTIES OF MERCHANTABILITY, FITNESS FOR USE AND FITNESS FOR A PARTICULAR PURPOSE, ARE SPECIFICALLY EXCLUDED. In no event will SHARP be liable, or in any way responsible, for any incidental or consequential economic or property damage.

SHARP®

NORTH AMERICA

SHARP Microelectronics of the Americas
5700 NW Pacific Rim Blvd.
Camas, WA 98607, U.S.A.
Phone: (1) 360-834-2500
Fax: (1) 360-834-8903
Fast Info: (1) 800-833-9437
www.sharpsma.com

EUROPE

SHARP Microelectronics Europe
Division of Sharp Electronics (Europe) GmbH
Sonninstrasse 3
20097 Hamburg, Germany
Phone: (49) 40-2376-2286
Fax: (49) 40-2376-2232
www.sharpsme.com

JAPAN

SHARP Corporation
Electronic Components & Devices
22-22 Nagaike-cho, Abeno-Ku
Osaka 545-8522, Japan
Phone: (81) 6-6621-1221
Fax: (81) 6117-725300/6117-725301
www.sharp-world.com

TAIWAN

SHARP Electronic Components
(Taiwan) Corporation
8F-A, No. 16, Sec. 4, Nanking E. Rd.
Taipei, Taiwan, Republic of China
Phone: (886) 2-2577-7341
Fax: (886) 2-2577-7326/2-2577-7328

SINGAPORE

SHARP Electronics (Singapore) PTE., Ltd.
438A, Alexandra Road, #05-01/02
Alexandra Technopark,
Singapore 119967
Phone: (65) 271-3566
Fax: (65) 271-3855

KOREA

SHARP Electronic Components
(Korea) Corporation
RM 501 Geosung B/D, 541
Dohwa-dong, Mapo-ku
Seoul 121-701, Korea
Phone: (82) 2-711-5813 ~ 8
Fax: (82) 2-711-5819

CHINA

SHARP Microelectronics of China
(Shanghai) Co., Ltd.
28 Xin Jin Qiao Road King Tower 16F
Pudong Shanghai, 201206 P.R. China
Phone: (86) 21-5854-7710/21-5834-6056
Fax: (86) 21-5854-4340/21-5834-6057

Head Office:

No. 360, Bashen Road,
Xin Development Bldg. 22
Waigaoqiao Free Trade Zone Shanghai
200131 P.R. China
Email: smc@china.global.sharp.co.jp

HONG KONG

SHARP-ROXY (Hong Kong) Ltd.
3rd Business Division,
17/F, Admiralty Centre, Tower 1
18 Harcourt Road, Hong Kong
Phone: (852) 28229311
Fax: (852) 28660779
www.sharp.com.hk

Shenzhen Representative Office:

Room 13B1, Tower C,
Electronics Science & Technology Building
Shen Nan Zhong Road
Shenzhen, P.R. China
Phone: (86) 755-3273731
Fax: (86) 755-3273735