

LS029B4DN01 LCD Module

Preliminary Product Specification

October 2009

WQVGA (Portrait) Silver Reflective PNLC
Memory LCD Module featuring FPC connector,
47% reflectivity with 6:1 contrast.

No.	LCY-12T09X02A
Date	16 th Oct, 2009

Technical Literature
For
TFT-LCD Module

Model No. LS029B4DN01

Notice

The technical Literature is subject to change without any prior notice for the purpose of product improvement. Please contact Sharp or its representative before designing your product based on this literature.

Mobile Liquid Crystal Display Group
SHARP CORPORATION

NOTICE**<<Precautions>>**

- These specification sheets are the proprietary product of SHARP CORPORATION ("SHARP") and include materials protected under copyright of SHARP. Do not reproduce or cause any third party to reproduce them in any form or by any means, electronic or mechanical, for any purpose, in whole or in part, without the express written permission of SHARP.
- The application examples in these specification sheets are provided to explain the representative applications of the device and are not intended to guarantee any industrial property right or other rights or license you to use them. SHARP assumes no responsibility for any problems related to any industrial property right of a third party resulting from the use of the device.
- SHARP reserves the right to make changes in the specifications, characteristics, data, materials, structures and other contents described herein at any time without notice in order to improve design or reliability. Contact SHARP in order to obtain the latest specification sheets before using any SHARP's device. Manufacturing locations are also subject to change without notice.

Observe the following points when in using any device in this publication. SHARP takes no responsibility for damage caused by improper use of the devices.

The devices in this publication are designed for use in general electronic equipment designs, such as:

- Personal computers
- Office automation
- Telecommunication equipment
- Test and measurement equipment
- Industrial control
- Audio visual and multimedia equipment
- Consumer electronics

The appropriate design measures should be taken to ensure reliability and safety when SHARP's devices are used for equipment such as:

- Transportation control and safety equipment(i.e.,aircraft,trains,automobiles,etc.)
- Traffic signals
- Gas leakage sensor breakers
- Alarm equipment
- Various safety devices etc.

○ SHARP's devices shall not be used for equipment that requires extremely high level of reliability, such as:

- Military and space applications
- Nuclear power control equipment
- Medical equipment for life support

- SHARP assumes no responsibility for any damage resulting from the use of the device which does not comply with the instructions and the precautions specified in these specification sheets.
- Contact and consult with a SHARP sales representative for any questions about this device.

[For handling and system design]

- (1) Handle with care as glass is used in this LCD panel. Dropping or contact against hard object may cause cracks or chips.
- (2) Be careful to handle this LCD panel in order to avoid injury yourself by panel's edge as this panel is made of glass and might be a sharp edge.
- (3) Do not scratch the surface of the UV protection film as it is easily damaged.
- (4) Water droplets on the UV protection film must be wiped off immediately as they may cause color changes, or other defects if remained for a long time.
- (5) Do not leave the LCD panel in direct sunlight or under ultraviolet ray.
- (6) To clean LCD panel surface, wipe clean with absorbent cotton or soft cloth. If further cleaning is needed, use IPA (isopropyl alcohol) and wipe clean lightly on surface only. Do not use organic

solvents as it may damage the LCD panel terminal area which uses organic material. Also, do not directly touch with finger. When the terminals cleaning are needed, those should be wiped by a soft cloth or a cotton swab without directly touching by hand.

(7) Do not expose gate driver, etc. on the panel (circuit area outside panel display area) to light as it may not operate properly. Design that shields gate driver, etc. from light is required when mounting the LCD module.

(8) To avoid circuit failure, do not touch panel terminal area.

(9) Support for the LCD panel should be carefully designed to avoid stress that exceeds specification on glass surface.

(10) When handling LCD module and assembling them into cabinets, be noted that storage in the environment of oxidization or deoxidization gas and the use of such materials as reagent, solvent, adhesive, resin, and etc. which generate these gasses, may cause corrosion and discoloration of LCD modules.

(11) To avoid picture uniformity failure, do not put a seal or an adhesive material on the panel surface.

(12) Do not use chloroprene rubber as it generates chlorine gas and affects reliability in LCD panel connective area.

(13) Protective film is attached to the surface of UV protection film on LCD panel to prevent scratches or other damages. Remove this protective film before use. In addition, do not attach the protective film which is removed from LCD module again. When the LCD panel which has the reattached protective film is stored for a long time, the UV protection film might have a damage with picture quality failure.

(14) Panel is susceptible to mechanical stress and such stress may affect the display. Place the panel on flat surface to avoid stress caused by twist, bend, etc.

(15) When transporting LCD panels, secure them in LCD panel tray to avoid mechanical stress. The tray should be conductive to protect LCD panels from static charge.

Material used in set or epoxy resin (amine type hardening agent) from packaging, and silicon adhesive (dealcoholized or oxime) all release gas which may affect quality of UV protection film. Do confirm compatibility with user materials.

(16) As this LCD module is composed of electronic circuits, it is sensitive to electrostatic discharge of 200V or more. Handle with care and follow the instructions below:

- Operators
Operators must wear anti-static wears to prevent electrostatic charge up to and discharge from human body.
- Equipment and containers
Process equipment such as conveyer, soldering iron, working bench and containers may possibly generate electrostatic charge up and discharge. Equipment must be grounded through 100Mohms resistance. Use ion blower.
- Floor
Floor plays an important role in leaking static electricity generated in human body or equipment. If the floor is made of insulated material (such as polymer or rubber material), such static electricity may charge. Proper measure should be taken to avoid static electricity charge (electrostatic earth: 100Mohms). There is a possibility that the static electricity is charged to them without leakage in case of insulating floor, so the electrostatic earth: $1 \times 10^8 \Omega$ should be made.
- Humidity
Humidity in work area relates to surface resistance of the persons or objects that generate electrostatics, and it can be manipulated to prevent electrostatic charge. Humidity of 40% or lower increases electrostatic earth resistance and promotes electrostatic charging. Therefore, the humidity in the work area should be kept above 40%. Specifically for film peeling process or processes that require human hands, humidity should be kept above 50% and use electricity removal blower.

- Transportation/Storage

Containers and styroform used in transportation and storage may charge electrostatic (from friction and peeling) or electrostatic charge from human body, etc. may cause containers and styroform to have induced charge. Proper electrostatic measure should be taken for containers and storage material.

[For operating LCD module]

- (1) Do not operate the LCD panel under outside of electrical specification. Otherwise LCD panel may be damaged.
- (2) Do not use the LCD panel under outside of specified driving timing chart. Otherwise LCD panel may not have proper picture quality.
- (3) A still image should be displayed for less than two hours, if it is necessary to display still image longer than two hours, display image data must be refreshed in order to avoid sticking image on LCD panel.
- (4) If LCD module takes a static electricity, as the display image which is written into pixel memory might not be displayed, Data update should be executed frequently.

[Precautions for Storage]

- (1) After opening the package, do not leave the LCD panel in direct sun or under strong ultraviolet ray. Store in dark place.
- (2) At temperatures lower than specified rating, liquid crystal material will coagulate. At temperatures higher than specified rating, it isotropically liquifies. In either condition, the liquid crystal may not recover its original condition. Store the LCD panels at or around room temperature as far as possible. Also, storing the LCD panel in high humidity will damage the polarizer. Store in normal humidity as far as possible.
- (3) Storing
 - a. Don't expose the panels to direct sunlight.
 - b. Keep the panels in trays and in the dark.

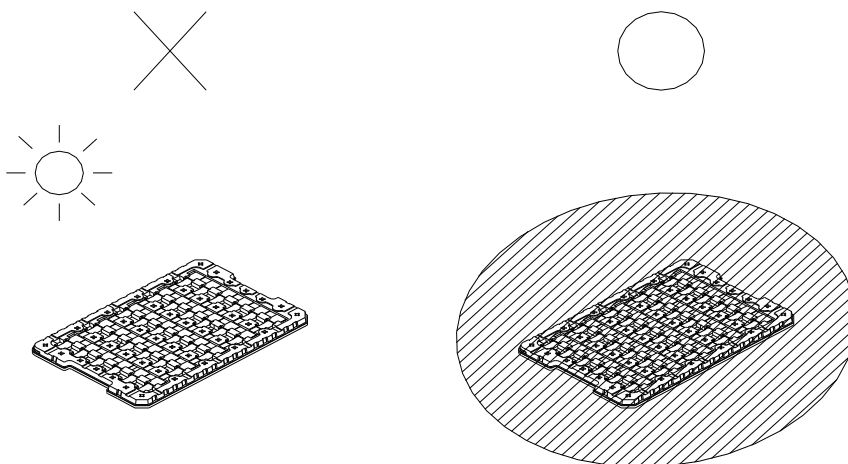

[Other Notice]

- (1) Operation outside specified environmental conditions cannot be guaranteed.
- (2) As power supply (VDD-GND) impedance is lowered during use, bus controller should be inserted near LCD module as much as possible.
- (3) UV protection film is applied over LCD panel surface. Liquid crystal inside LCD panel deteriorates with ultraviolet ray. The panel should not be left in direct sun or under strong ultraviolet ray for prolonged period of time even with the UV protection film.
- (4) Disassembling the LCD module will cause permanent damage to the module. Do not disassemble the module.
- (5) If LCD panel is broken, do not ingest the liquid crystal from the broken panel. If hand, leg, or clothes come in contact with liquid crystal, wash off immediately with soap.
- (6) ODS (specific chlorofluorocarbon, specific halon, 1-1-1 trichloroethane, carbon tetrachloride) are not used or contained in material or all production processes of this product.
- (7) Observe all other precautionary requirements in handling general electronic components.

Discarding liquid crystal modules

LCD Panel : Dispose of as glass waste. This LCD module contains no harmful substances.

The liquid crystal panel contains no dangerous or harmful substances.

This liquid crystal panel contains only an extremely small amount of liquid crystal (approximately 100mg) and therefore it will not leak even if the panel should break.

Its median lethal dose (LD50) is greater than 2,000 mg/kg and a mutagenetic (Aims test: negative) material is used.

FPC : (1) FPC bend R should be 0.6mm or greater and R should be even.

As for connective area of LCD panel, do not bend FPC into UV protection film side.

(2) Do not hang LCD module at FPC or apply force to FPC.

Contents

1. Scope of Application	6
2. Overview	6
3. Mechanical Specification	6
4. Input terminal names and functions	7
5. Structure	8
6. Absolute Maximum Rating	10
7. Electrical characteristics	11
8. Sequence	14
9. Example of electric connection diagrams	20
10. Optical characteristics	21
11. Packaging	23
12. Reliability Test condition	25
13. Handling for TFT - module	26

1. Scope of Application

Reflective active-matrix type memory liquid crystal display module with 240x456 dots panel which uses CG silicon thin film transistor.

2. Overview

- 2.94” 240x456 dots monochrome PNLC (Polymer Network Liquid Crystal) reflective panel
- 240x456 dot stripe arrangement
- Display control with serial data signal communication
- Arbitrary line data update
- Internal 1bit memory within the panel for data memory
- Thin, light and compact module with monolithic technology
- Super low power consumption TFT panel

3. Mechanical Specification

Table 3-1

Item	Specification	unit
Screen size	7.468 (2.94”)	cm
Viewing Area	34.8 (H) × 66.12 (V)	mm
Dot configuration	240 (H) × 456 (V)	Dot
Dot pitch	0.145 (H) × 0.145 (V)	mm
Pixel Array	Square Array	-
Outline Dimension	39.6 (W) × 73.9 (H) × 0.55 (D)	mm
Mass	3.7 (TYP)	g
Surface Hardness	3H	Pencil hardness

(Note) Detail dimension and tolerance are shown in fig. 5-1
The FPC shape isn't included in the outline dimension.

4. Input terminal names and functions

Table 4-1

No.	symbol	I/O	Voltage	Function	Remark
1	TCOM1	I	0 / 5(V)	COM inversion input signal	
2	SCLK	I	0 / 3.0(V)	Serial clock signal	
3	SI	I	0 / 3.0(V)	Serial data input signal	
4	SCS	I	0 / 3.0(V)	Chip select signal	
5	DISP	I	0 / 3.0(V)	Display ON/OFF signal	[Remark6-2]
6	DMYCTL	I	0 / 3.0(V)	Display-mode select signal	
7	N.C	—	—	—	
8	N.C	—	—	—	
9	N.C	—	—	—	
10	N.C	—	—	—	
11	EXTCOMIN	I	0 / 3.0(V)	COM inversion-polarity select terminal	[Remark6-1]
12	VDD	I	5.0(V)	POWER(Digital)	
13	EXTMODE	I	0 / 5(V)	COM inversion-mode select terminal	
14	VSS	I	0.0(V)	GND(Digital)	
15	TCOM2	I	0 / 5(V)	COM inversion input signal	

[Remark4-1] When it's "H", EXTCOMIN signal is enable. And when it's "L", serial input flag is enable. "H" mode; connect the EXTMODE to VDD, "L" mode; connect the EXTMODE to VSS.

[Remark4-2] The display ON/OFF signal is only for display. Data in the memory will be saved at the time of ON/OFF.

When it's "H", data in the memory will display, when it's "L", white color will display and data in the memory will be saved.

5. Structure

This LCD module consists of a Liquid-Crystal-Display Panel, UV-Cut film, and Antiscattering film. The structure is shown in Fig 5-1.

5-1. LCD-FPC specifications

- (1) Conformity connector
10064555-152110ELF (Product made in F.C.I.Co.)
0.3mm-pitch / Cross-stitch
- (2) Flexibility-resistant of FPC
In a flexural examination equal to or less than 30 times, the line of the FPC do not burst.
(Flexure radius = R0 .6mm / flexural angle =90 degrees)
- (3) LCD-FPC connection diagram
LCD-FPC connection diagram is shown in Fig 5-2.

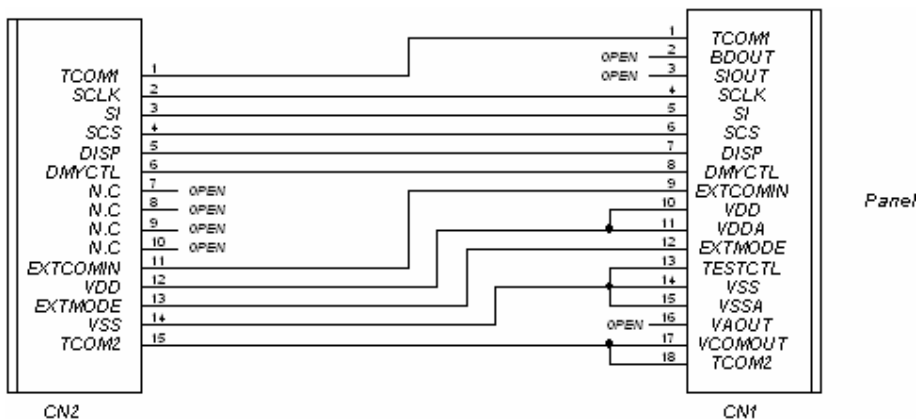

Fig 5-2

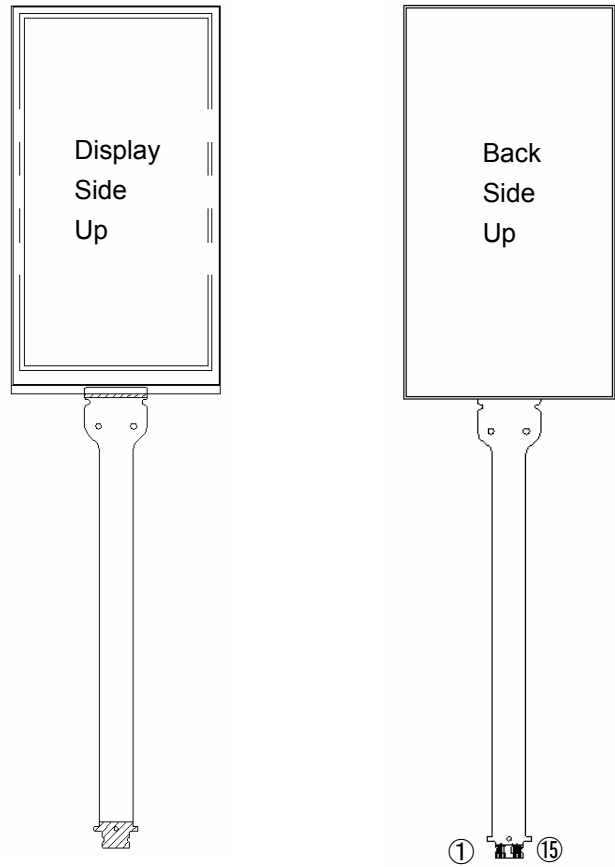

Fig 5-2

6. Absolute Maximum Rating

Table6-1

(VSS=0V)

Item	Symbol	MIN.	MAX.	Unit	Remark
Power supply voltage (Digital)	VDD	-0.3	+5.8	V	[Remark6-1]
Input signal voltage	Vin	-0.3	VDD	V	[Remark6-2]
Storage Temperature	Tstg	-20	+70	°C	[Remark6-3,4]
Operation Temperature (at panel surface)	Topr1	-10	+60	°C	[Remark6-5]

[Remark6-1] Applies to EXTMODE.

[Remark6-2] Applies to SCS,SCLK, SI, DISP, DMYCTL,EXTCOMIN.

[Remark6-3] Do not exceed this temperature in any parts of module.

[Remark6-4] Maximum wet bulb temperature is 57°C or lower. No condensation is allowed.

Condensation will cause electrical leak and may cause the module not to meet this specification.

[Remark6-5] Operating temperature is the temperature that guarantees the operation only.

For contrast, response time, and other display quality determination,
use Ta= +25°C.

7. Electrical characteristics

7-1) Recommended operating Condition

Table 7-1

(VSS=0V, Ta= +25°C)

Item	Symbol	Condition	MIN.	TYP.	MAX.	Unit	Remark
Power supply voltage (Digital)	VDD		+4.8	+5.0	+5.5*	V	
Input signal voltage	Hi	Vin	+2.70	+3.00	+5.5	V	[Remark7-1]
	Lo	Vin	VSS	-	VSS+0.15	V	

* Vin < VDD

[Remark7-1] Applies to SCS,SCLK, SI, DISP,DMYCTL, EXTCOMIN.

7-2) DC-Electrical characteristics

Table 7-2

(Ta=25°C, SCS,SCLK,SI,DISP,DMYCTL,EXTCOMIN=3.0V, VDD=5.0V, VSS =0V)

Item	Symbol	Condition	MIN	TYP	MAX	Unit	Remark
Input signal current-1	I _{VDD1}	Condition1		10	50	uA	[Remark7-2]
Input signal current-2	I _{VDD2}	Condition2		250	1,100	uA	[Remark7-2]

* Measurement Condition 1

Display mode (no display data update), Display pattern : All - Black display

DMYCTL = Hi (Dummy-area : Black) , SCS = SCLK = SI = Lo , EXTCOMIN = 1Hz

* Measurement Condition 2

Data update mode (with display data update : 1Hz), Display pattern : Vertical stripe display

DMYCTL = Hi (Dummy-area : Black) , SCLK = 2.05Hz , EXTCOMIN = 1Hz

[Remark 7-2] EXTMODE = Hi

7-3) Electrical characteristics

Table 7-3

(Ta=25°C, SCS,SCLK,SI,DISP,DMYCTL,EXTCOMIN=3.0V, VDD=5.0V, VSS=0V)

Terminal	Item	Symbol	MIN	TYP	MAX	Unit	Remark
SCS	Frame frequency	fSCS	1	-	17.03	Hz	
SCLK	Clock frequency	fSCLK		1	2.05	MHz	
	Vertical Interval	tV	58.73	-	1000	ms	
	COM Frequency	fCOM	0.5	-	8.52	Hz	

7-4) Input signal-electrical characteristics

Table 7-4 (Ta=25°C、SCS,SCLK,SI,DISP,DMYCTL,EXTCOMIN=3.0V、VDD=5.0V、VSS =0V)

Terminal	Item	Symbol	MIN	TYP	MAX	Unit	Remark
SCS	SCS Rising time	trSCS	-	-	50	ns	
	SCS Falling Time	tfSCS	-	-	50	ns	
	SCS High duration	twSCSH	144.5	-	-	us	
			6.93	-	-	us	
	SCS Low duration	twSCSL	1	-	-	us	
	SCS set up time	tsSCS	3	-	-	us	
	SCS hold time	thSCS	1	-	-	us	
SI	SI frequency	fSI	-	0.5	1.025	MHz	
	SI Rising time	trSI	-	-	50	ns	
	SI Folling time	tfSI	-	-	50	ns	
SCLK	SCLK Rising time	trSCLK	-	-	50	ns	
	SCLK Folling time	tfSCLK	-	-	50	ns	
	SCLK set-up time	tsSCLK	200			ns	
	SCLK hold time	thSCLK	125			ns	
	SCLK High duration	twSCLKH	200	450	-	ns	
	SCLK Low duration	twSCLKL	200	450	-	ns	
EXTCOMIN	EXTCOMIN signal freequency	fEXTCOMIN		1	17.03	Hz	[Remark7-3]
	EXTCOMIN signal rising time	trEXTCOMIN	-	-	50	ns	
	EXTCOMIN signal folling time	tfEXTCOMIN	-	-	50	ns	
	EXTCOMIN signalHigh duration	twEXTCOMIN	1			us	
DISP	DISP Rising time	trDISP	-	-	50	ns	
	DISP Folling time	tfDISP	-	-	50	ns	
DMYCTL	DMCTL Rising time	trDMCTL			50	ns	
	DMCTL Folling time	tfDMCTL			50	ns	

[Remark 7-3] EXTCOMIN frequency should be made lower than frame frequency.

Terminal	Item	Symbol	Wave-form	Remark
SCS	SCS Rising time	trSCS		
	SCS Falling Time	tfSCS		
	SCS High duration	twSCSH		
	SCS Low duration	twSCSL		
	SCS set up time	tsSCS		
	SCS hold time	thSCS		
SI	SI Rising time	trSI		
	SI Folling time	tfSI		
	SI set-up time	tsSCS		
	SI hold time	thSCS		
SCLK	SCLK Rising time	trSCLK		
	SCLK Folling time	tfSCLK		
	SCLK High duration	twSCLKH		
	SCLK Low duration	twSCLKL		
EXTCOMIN	EXTCOMIN signal rising time	trEXTCOMIN		
	EXTCOMIN signal folling time	tfEXTCOMIN		
	EXTCOMIN signalHigh duration	twEXTCOMIN		
DISP	DISP Rising time	trDISP		
	DISP Folling time	tfDISP		
DMYCTL	DMCTL Rising time	trDMCTL		
	DMCTL Folling time	tfDMCTL		

Fig 7-4

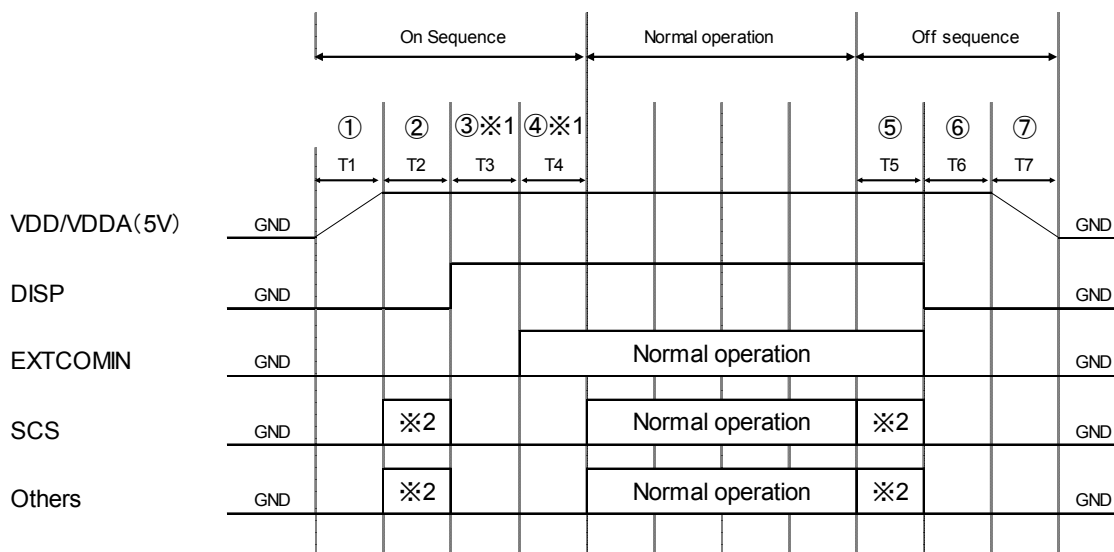
8.Sequence**8-1) Power supply sequence**

* Refer to timing chart and AC timing characteristics for detail

* 1 ③ and ④ may be opposite (however, TCOM polarity inversion will not occur even with EXTCOMIN between DISP="L". Also, when DISP and EXTCOMIN are simultaneously started up, allow 30us or more before SCS starts up (It may be less than 60us).

* 2 Setting value for pixel memory initialization

SCS=Driving accordingly to clear pixel internal memory method (use all clear flag or write all screen white)

S1=M2 (all clear flag) = "H" or write white

SCLK: Normal Driving

[ON Sequence]

(1) 5V rise time (depends on IC)

(2) Pixel memory initialization T2: 1V or more Initialize with M2 (all clear flag) or write all screen white

(3) Release time for initialization of TCOM latch T3: 30us or more

Time required to release COM related latch circuit initialization which is initializing using DISP signals

(4) TCOM polarity initialization time T4: 30us or more

Time required for initializing TCOM polarity according to EXTCOMIN input

[Normal Operation]

Duration of normal driving

[Off Sequence]

(5) Pixel memory initialization time T5: 1V or more. Otherwise it can be set that T5 should be input after all clear flag input.

(6) VA, VB, VCOM initialization time T6: 1V or more

(7) 5V falling time (Depends on IC)

8-2) Input Signal Timing Chart

8-2-1 Data update mode (1 line)

Updates data of only one specified line. (M0="H", M2="L")

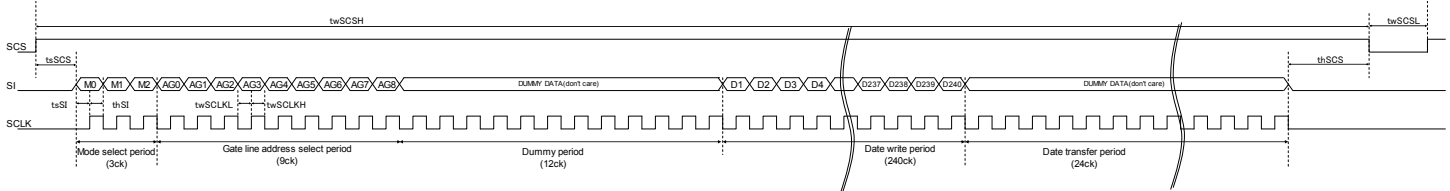

M0: Mode flag. Set for "H". Data update mode (Memory internal data update)

When "L", display mode (maintain memory internal data).

M1: Frame inversion flag.

When "H", outputs VCOM="H", and when "L", outputs VCOM="L".

When EXTMODE="H", it can be "H" or "L".

M2: All clear flag.

Refer to 8-2-4) All Clear Mode to execute clear.

DUMMY DATA: Dummy data. It can be "H" or "L" ("L" is recommended.)

* Data write period

Data is being stored in 1st latch block of binary driver on panel.

* Data transfer period

Data written in 1st latch is being transferred (written) to pixel internal memory circuit.

Gate line address setup

GL	AG0	AG1	AG2	AG3	AG4	AG5	AG6	AG7	AG8
1	1	0	0	0	0	0	0	0	0
2	0	1	0	0	0	0	0	0	0
3	1	1	0	0	0	0	0	0	0
4	0	0	1	0	0	0	0	0	0
5	1	0	1	0	0	0	0	0	0
6	0	1	1	0	0	0	0	0	0
7	1	1	1	0	0	0	0	0	0
8	0	0	0	1	0	0	0	0	0
:	:	:	:	:	:	:	:	:	:
450	0	1	0	0	0	0	1	1	1
451	1	1	0	0	0	0	1	1	1
452	0	0	1	0	0	0	1	1	1
453	1	0	1	0	0	0	1	1	1
454	0	1	1	0	0	0	1	1	1
455	1	1	1	0	0	0	1	1	1
456	0	0	0	1	0	0	1	1	1

8-2-2 Data Update Mode (Multiple Lines)
Updates arbitrary multiple lines data. (M0="H")

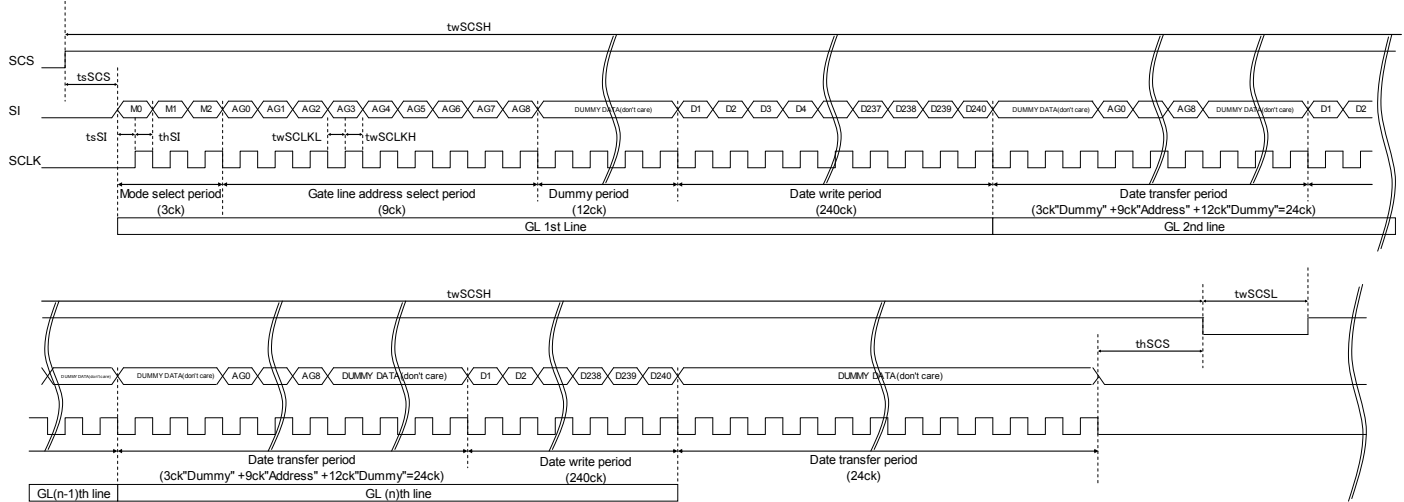

- M0: Mode flag. Set for "H". Data update mode (Memory internal data update)
When "L", display mode (maintain memory internal data).
- M1: Frame inversion flag.
When "H", outputs VCOM="H", and when "L", outputs VCOM="L".
When EXTMODE="H", it can be "H" or "L".
- M2: All clear flag.
Refer to 8-2-4) All Clear Mode to execute clear.
- DUMMY DATA: Dummy data. It can be "H" or "L" ("L" is recommended.)

* Data write period
Data is being stored in 1st latch block of binary driver on panel.

* Data transfer period
For example, during GL2nd line data transfer period, GL 2nd line address is latched and GL1st line data is transferred from 1st latch to pixel internal memory circuit at the same time.

8-2-3 Display Mode

Maintains memory internal data (maintains current display). (M0="L")

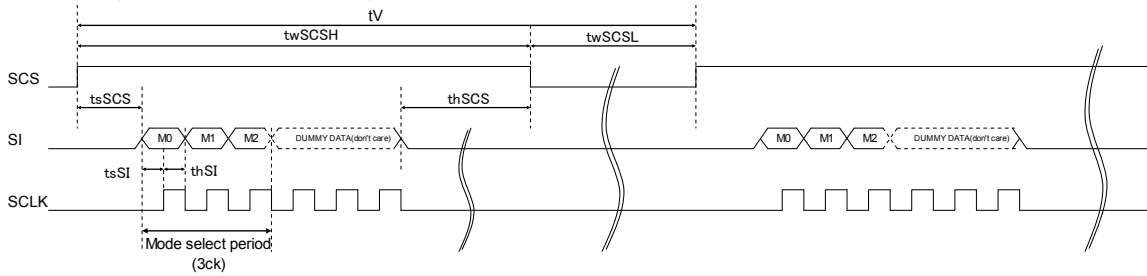

- M0: Mode flag. Set for "H". Data update mode (Memory internal data update)
When "L", display mode (maintain memory internal data).
- M1: Frame inversion flag.
When "H", outputs VCOM="H", and when "L", outputs VCOM="L".
When EXTMODE="H", it can be "H" or "L".
- M2: All clear flag.
Refer to 8-2-4) All Clear Mode to execute clear.
- DUMMY DATA: Dummy data. It can be "H" or "L" ("L" is recommended.)

8-2-4 All Clear Mode

Clears memory internal data and writes white.

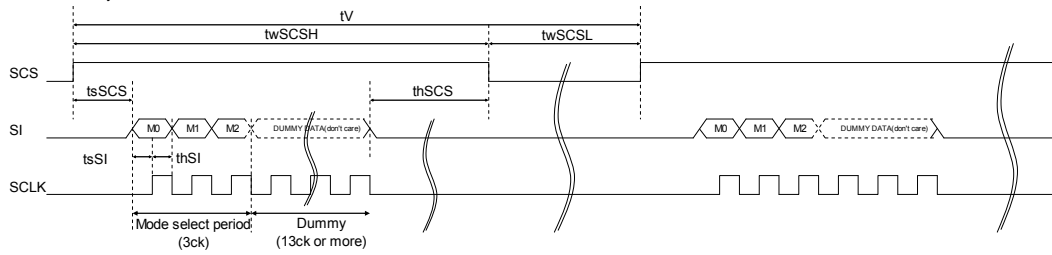

- M0: Mode flag.
Set it "L".
- M1: Frame inversion flag.
When "H", outputs VCOM="H", and when "L", outputs VCOM="L".
When EXTMODE="H", it can be "H" or "L".
- M2: All clear flag.
Set it "H".
- DUMMY DATA: Dummy data. It can be "H" or "L" ("L" is recommended.)

8-3) COM inversion

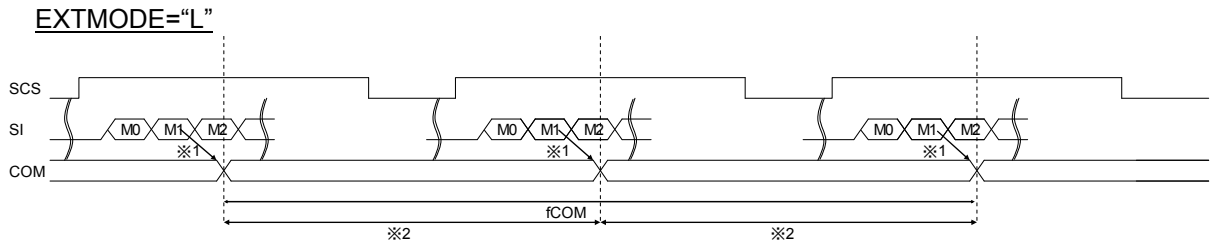

M1 :LC polarity inversion flag: If M1is "H" then VCOM="H" is output. If M1 is "L" then VCOM="L" is output.

※1:LC inversion has been changed by M1 flag statement.

※2: The periods of plus polarity and minus polarity should be same length as much as possible.

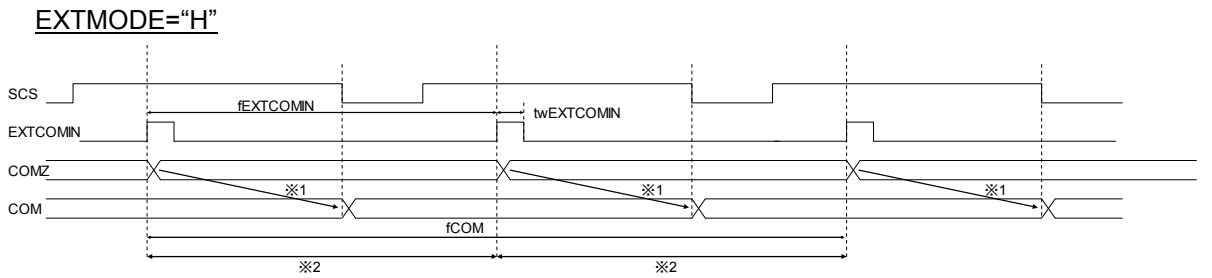

※1:LC inversion polarity has been set by the rising timing of EXTCOMIN in internal circuit block as COMZ signal,

※2: The period of EXTCOMIN should be constant.

8-4) Truth table of COM-signal

<EXTMODE="L">

	COM	
EXTCOMIN	COM depend on a flag of the M1	
L		
L		
H \bar{f}		
H \bar{f}		

<EXTMODE="H">

	COMZ	
EXTCOMIN	Before inversion	After inversion
	L	L
L	H	H
H \bar{f}	L	H
H \bar{f}	H	L

COMZ turn over in a height of the rise edge of EXTCOMIN.
(COMZ-signal is done a latch of with a scs-signal.)

	COM	
COMZ	SCS="L"	SCS="H"
	L	Qn-1
H	H	Qn-1

※Qn-1: The value that I maintained at a point in time when an SCS signal was in L → H.

9. Example of electric connection diagrams

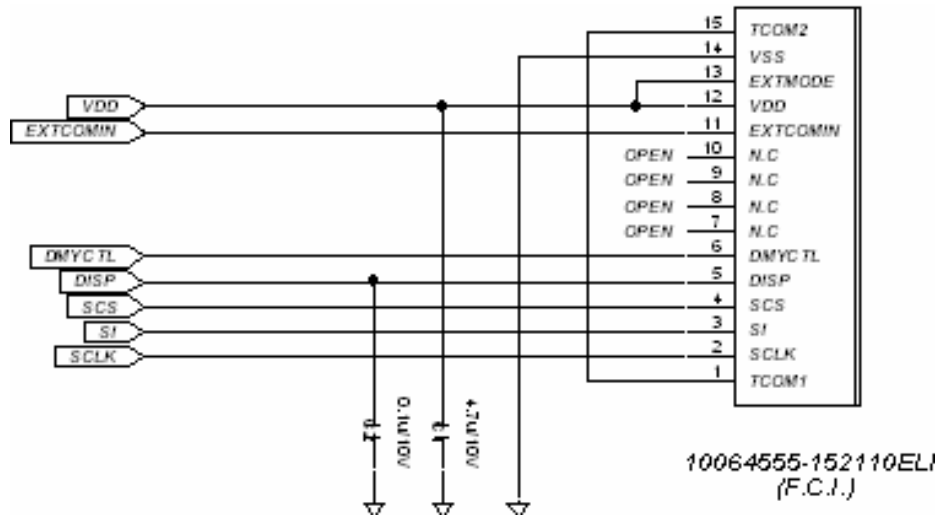

- (*) The circuit and the part shown above are a recommended example.
- (*) Please design it after having had you evaluate consistency with your company system on the occasion of use.

Fig 9-1

10. Optical characteristics

Tble.10-1

Parameter	Symbol	Condition	MIN.	TYP.	MAX.	Unit	Remark
Reflection Ratio		$\theta=0^\circ$	44	47	—	%	10-1(b),(e)
Contrast ratio	CR	$\theta=0^\circ$	5	6	—	—	10-1(c),(e)
Viewing angle range	θ_{11}	$Co \geq 2$	50	60	—	°	10-1(a),(d)
	θ_{12}		50	60	—		
	θ_{21}		50	60	—		
	θ_{22}		50	60	—		
Chromaticity	White	$\theta=0^\circ$	W_x	0.31		—	10-1 (e)
			W_y	0.330			

Test Condition : Ta = 25°C

10-1) Measurement method

(a) Definition of the viewing angle range

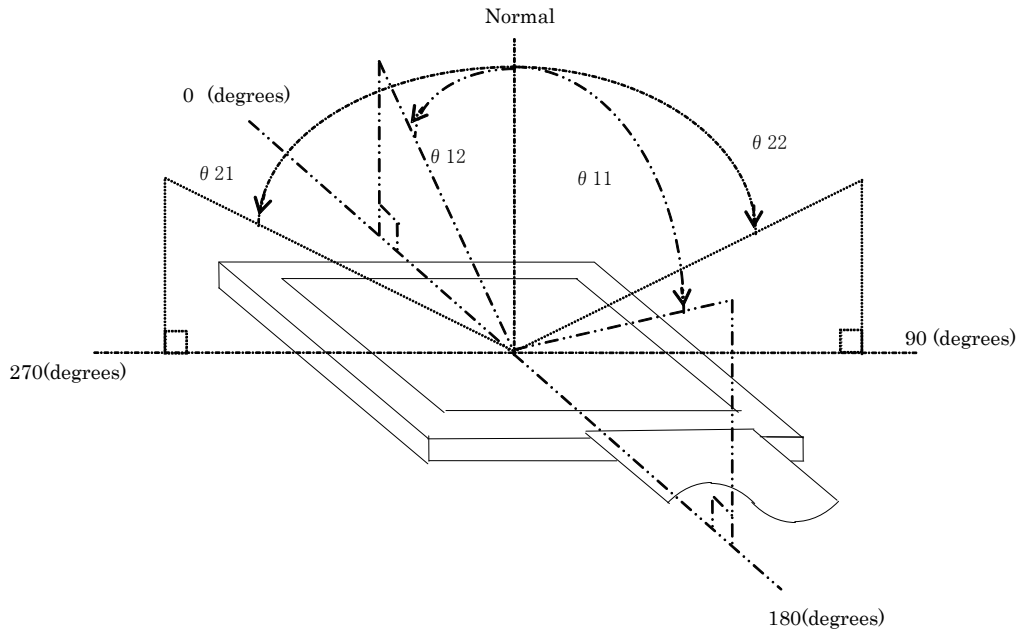

Fig 10-1

(b) Definition of the reflectance

$$\text{Reflectance} = \frac{\text{Reflection brightness at the time of the white indication}}{\text{Reflection brightness of the reference white board}}$$

(c) Definition of the contrast ratio (Reflection mode)

$$\text{Contrast ratio (Reflection mode)} = \frac{\text{Reflectance of the panel center point (at white indication)}}{\text{Reflectance of the panel center point (at black indication)}}$$

(d) Viewing angle range (Reflection mode)

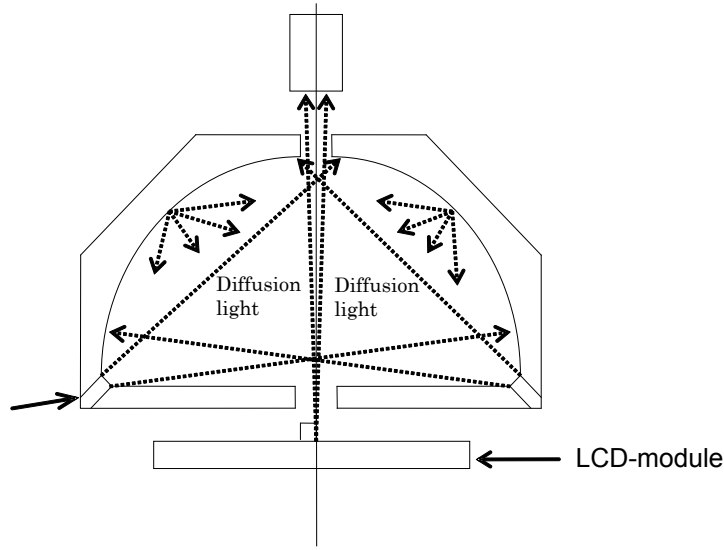

□ The measurement by LCD5200

Fig 10-2

(e) Brightness/Chromaticity (Reflection mode)

The measurement by CM2002 (Product made by MINOLTA.Co.)

Based on a source of light (D65)

11. Packaging

11-1) Lot number

Lot numbering and location are specified as follows.

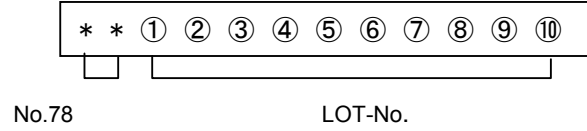

•Lot-No.

- ① : Blank
- ② : Product year (lower 2 digits)
08 : 2008
09 : 2009
- ③ : Product month
A : JANUARY
B : FEBRUARY
C : MARCH
:
:
L : DECEMBER
- ④ ~ ⑨ : Serial number
000001 ~ 999999
- ⑩ : Production place

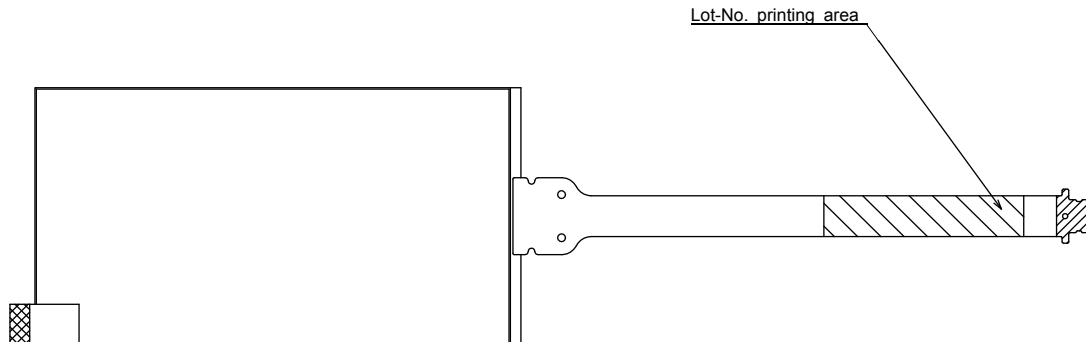

Fig 11-1

11-2) Package Storing

- ① Maximum number of carton in a stack : 10 cartons
Maximum quantity of units in carton : 480 units per carton
- ② Storage condition
 - Temperature : 0~40 (°C)
 - Humidity : less than 60%RH (at40°C)
No condensation
 - Gus : No harmful gas, such as acid or alkali, which causes severe corrosion on electronic parts and wiring, are to be detected. (acid,alkaline-gus etc.)
 - Length : About 3 months
 - Opening the package: in order to prevent electrostatic damage to LCD modules, room humidity should be kept over 50%RH and take effective measure such as use of earth when opening the package.

11-3) Packaging form

Packaging condition is shown in Figure 11-2.

12. Reliability Test condition

12-1. Reliability Test item

Table.12-1

	Item	Contents	Remark
1	High temperature storage	Ta=70°C 240h	-
2	Low temperature storage	Ta=-20°C 240h	-
3	High temperature/humidity operation	Tp=40°C / 95%RH 240h	-
4	High temperature operation	Ta=60°C / Time=240h	-
5	Low temperature operation	Ta=-10°C / Time=240h	-
6	Heat shock	•Ta=-20°C(1hour)~+70°C(1hour) / cycle •5cycles (Non-operating)	-
7	Electrostatic discharge	±200V、200pF(0Ω) , 1 time/ each terminal	-

Ta : Ambient temperature
Tp : Temperature of panel

<Evaluation method>

In standard condition, there shall be no practical problems that may affect the display function.

12-2) Panel surface stress specification

“Force of stress [N]” without display failure (display non-uniformity) is defined as follow:

Load testing: Minimum 120[N]

<Test condition>

- Test structure : LCD panel with UV protection film
- Press point : Center of LCD panel
- Press Jig : φ10mm column
- Press speed : 1mm/minute
- Support : Secured on stage
- Press time : Hold for 5 seconds after reaching test press load and then release.

13. Handling for TFT - module**13-1) Installation to an FPC connector.**

In case of inserting FPC to a connector or drawing FPC out from a connector, the system in which TFT-LCD module has been installed should be turned off. Otherwise, TFT-LCD might have an electronic damage with display failure.

13-2) Handling of the FPC

When bending FPC, bend where specified in Condition (1) and the bend R should be more than R specified in Condition (2). FPC is not to contact glass edge, and there should be no stress to connective area between the panel and the FPC.

Condition (1) FPC bend recommended area: more than 0.75 mm from glass edge.

Condition (2) Minimum bend R: Inner diameter R0.6 mm

When handling TFT-LCD module, avoid picking up FPC only. That might cause electrical failure by FPC mechanical damage.

Terminal Assignment

Pin	Symbol
1	TCOM1
2	SCLK
3	SI
4	SCS
5	DISP
6	DMYCTL
7	N _i C
8	N _i C
9	N _i C
10	N _i C
11	EXTCOMIN
12	VDD
13	EXTMODE
14	VSS
15	TCOM2

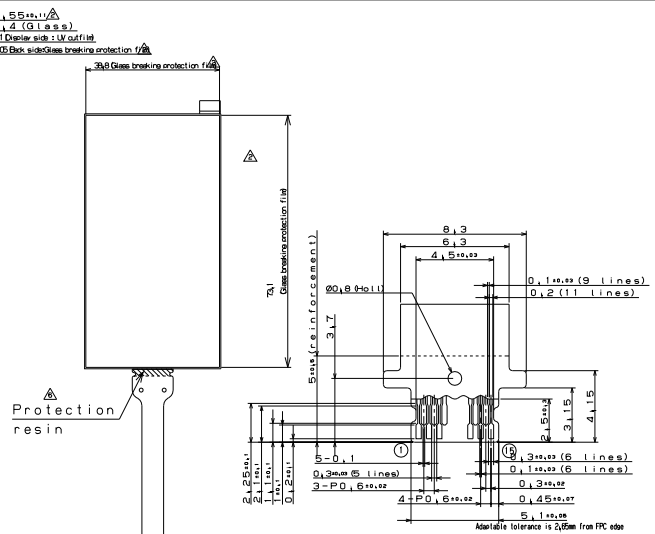
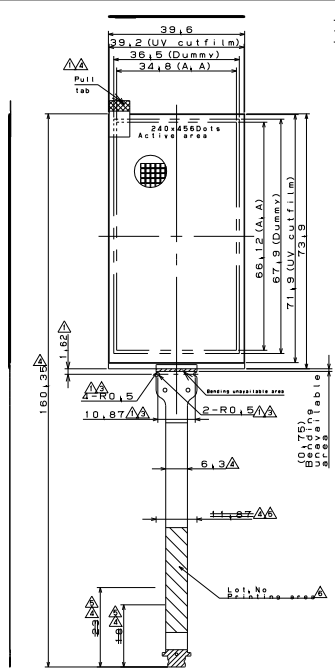

•Notice
 •FPC bending R must be more than 0,6
 Otherwise FPC might be broken,

List | Tolerance

mm	inch
0.05	0.002
0.1	0.004
0.2	0.008
0.5	0.020
1	0.040
2	0.080
3	0.120
4	0.160
5	0.200
6	0.240
8	0.320
10	0.400
15	0.600
20	0.800
30	1.200
40	1.600
50	2.000
60	2.400
80	3.200
100	4.000

DATE	REVISE	PREPA	MODEL
2009_03_10	Final version		
2009_03_02	Resin area, Lot, No. printing area		
2009_02_09	To add Resin area, Lot, No. printing area		

DATE	REVISE	PREPA	MODEL	NAME
2009_02_06	FPC shape, Pull tab area changed			Nakajima
2009_01_29	FPC cutting R gas changed			Nakajima
2009_01_13	To add Glass breaking protection film			Nakajima
2008_12_24	To add FPC shape, Pull tab			Nakajima
			LS029B4DN01	

SCALE	SYMBOL	PARTS CODE	DATE	DRAWING No.
1/1			2008.11.26	S029B0LD176117

Fig 5-1 External form dimensions

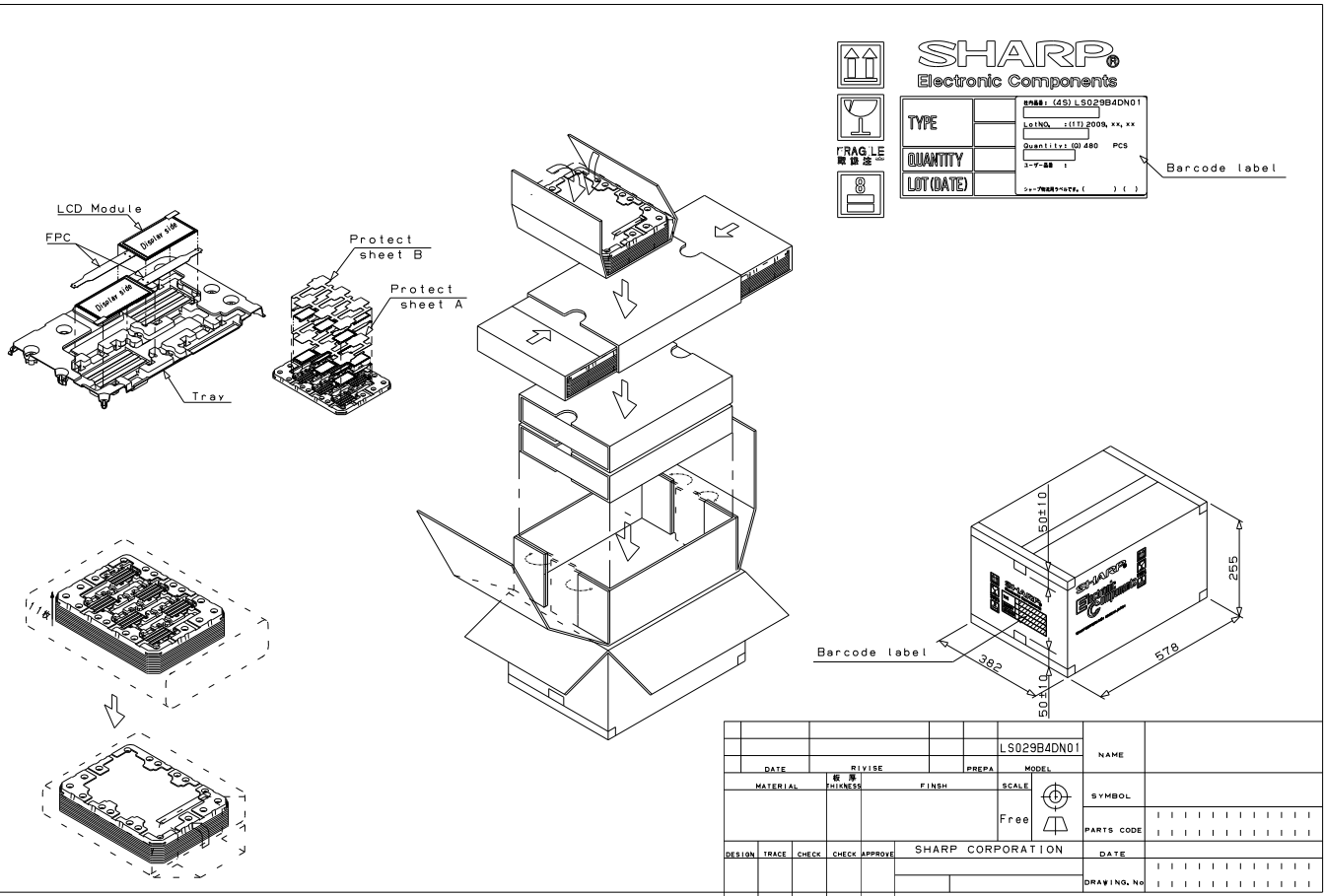

SHARP
Electronic Components

TYPE	LS029B4DN01
QUANTITY	Quantity: 480 PCS
LOT (DATE)	Lot: 78887474 () ()

Barcode label

				LS029B4DN01	NAME	
DATE	REVISE	PREPA	MODEL			
MATERIAL	板厚 THICKNESS	FINISH	SCALE	Free	SYMBOL	
DESIGN	TRACE	CHECK	CHECK APPROVE	SHARP CORPORATION	DATE	
					DRAWING No.	

Fig 11-2

LCD Specification

LCD Group



NORTH AMERICA

Sharp Microelectronics of the Americas
5700 NW Pacific Rim Blvd.
Camas, WA 98607, U.S.A.
Phone: (1) 360-834-8700
Fax: (1) 360-834-8903
www.sharpsma.com

TAIWAN

Sharp Electronic Components
(Taiwan) Corporation
8F-A, No. 16, Sec. 4, Nanking E. Rd.
Taipei, Taiwan, Republic of China
Phone: (886) 2-2577-7341
Fax: (886) 2-2577-7326/2-2577-7328

CHINA

Sharp Microelectronics of China
(Shanghai) Co., Ltd.
28 Xin Jin Qiao Road King Tower 16F
Pudong Shanghai, 201206 P.R. China
Phone: (86) 21-5854-7710/21-5834-6056
Fax: (86) 21-5854-4340/21-5834-6057
Head Office:
No. 360, Bashen Road,
Xin Development Bldg. 22
Waigaoqiao Free Trade Zone Shanghai
200131 P.R. China
Email: smc@china.global.sharp.co.jp

EUROPE

Sharp Microelectronics Europe
Division of Sharp Electronics (Europe) GmbH
Sonninstrasse 3
20097 Hamburg, Germany
Phone: 49 (0)180 507 35 07
Fax: (49) 40-2376-2232
www.sharpsme.com

SINGAPORE

Sharp Electronics (Singapore) PTE., Ltd.
438A, Alexandra Road, #05-01/02
Alexandra Technopark,
Singapore 119967
Phone: (65) 271-3566
Fax: (65) 271-3855

KOREA

Sharp Electronic Components
(Korea) Corporation
RM 501 Geosung B/D, 541
Dohwa-dong, Mapo-ku
Seoul 121-701, Korea
Phone: (82) 2-711-5813 ~ 8
Fax: (82) 2-711-5819

JAPAN

Sharp Corporation
Electronic Components & Devices
22-22 Nagaïke-cho, Abeno-Ku
Osaka 545-8522, Japan
Phone: (81) 6-6621-1221
Fax: (81) 6117-725300/6117-725301
www.sharp-world.com

HONG KONG

Sharp-Roxy (Hong Kong) Ltd.
Level 26, Tower 1, Kowloon Commerce Centre,
No. 51, Kwai Cheong Road, Kwai Chung,
New Territories, Hong Kong
Phone: (852) 28229311
Fax: (852) 28660779
www.sharp.com.hk
Shenzhen Representative Office:
Room 602-603, 6/F,
International Chamber of Commerce Tower,
168 Fuhua Rd. 3, CBD,
Futian District, Shenzhen 518048,
Guangdong, P.R. China
Phone: (86) 755-88313505
Fax: (86) 755-88313515

SPECIFICATIONS ARE SUBJECT TO CHANGE WITHOUT NOTICE.

Suggested applications (if any) are for standard use; See Important Restrictions for limitations on special applications. See Limited Warranty for SHARP's product warranty.

The Limited Warranty is in lieu, and exclusive of, all other warranties, express or implied.

ALL EXPRESS AND IMPLIED WARRANTIES, INCLUDING THE WARRANTIES OF MERCHANTABILITY, FITNESS FOR USE AND FITNESS FOR A PARTICULAR PURPOSE, ARE SPECIFICALLY EXCLUDED. In no event will SHARP be liable, or responsible in any way, for any incidental or consequential economic or property damage.