

for Non-Fusible Disconnect Switches

CDNF16 – CDFN160



CDNF16 CDFN25 CDFN32



CDNF30 CDFN60 CDFN100



CDNF160

Catalog number	3 pole	CDNF16	CDNF25	CDNF32	CDNF45	CDNF63	CDNF30	CDNF60	CDNF100	CDNF160
General purpose amp rating	A	16	25	40	60	80	30	60	100	125
Approvals ^①										
	2 pole	N/A	N/A	N/A	N/A	N/A	N/A	N/A	N/A	UL98
	3 pole	UL508	UL508	UL508	UL508	UL508	UL98	UL98	UL98	UL98
	4 pole	UL508	UL508	UL508	UL508	UL508	UL98	UL98	UL98	UL98
Technical ratings										
UL, CSA^②										
Max operating voltage	V	600	600	600	600	600	600	600	600	600
Max horsepower rating										
Three phase										
200 – 208V	HP	3	7.5	10	15	20	10	20	25	—
240V	HP	5	7.5	10	15	20	10	20	25	30
480V	HP	10	15	20	30	40	20	40	50	60
600V	HP	10	20	25	20	40	30	40	40	75
Single phase										
120V	HP	1/2	3/4	1	2	2	2	3	5	7.5
240V	HP	1.5	2	3	5	5	5	7.5	15	20
Technical ratings										
IEC^③										
Rated insulation and operational voltage. AC20 and DC20 ^④	V	750	750	750	750	750	750	750	750	750
Rated thermal current, I _{in}										
AC 20/DC 20 open	A	25	32	40	63	80	40	63	115	200
AC 20/DC 20 enclosed	A	25	32	40	63	80	40	63	115	160
AC 21A 500V	A	16	25	32	63	80	40	63	100	160
690V	A	16	25	32	63	80	40	63	100	160
Rated operational power AC23										
400/415V	kW	7.5	9	11	22	37	15	18.5	37	75
690V	kW	7.5	9	11	15	18.5	15	15	37	75
Physical characteristics										
Weight ^④	3 pole lb	0.24	0.24	0.24	0.59	0.59	0.79	0.79	0.79	2.42
Dimension	3 pole H in	2.68	2.68	2.68	3.60	3.60	3.94	3.94	3.94	5.00
	W in	1.38	1.38	1.38	2.07	2.07	2.76	2.76	2.76	4.96
	D in	2.20	2.20	2.20	2.85	2.85	2.95	2.95	2.95	2.93
Accessories										
Terminal lug kit		Integral	Integral	Integral	Integral	Integral	Integral	Integral	Integral	integral
Terminal shroud		•	•	•	•	•	•	•	•	•
Auxiliary contact		•	•	•	•	•	•	•	•	•
Handle UL/NEMA type										
Type 1, 3R, 12		•	•	•	•	•	•	•	•	•
Type 1, 3R, 4, 4X, 12		•	•	•	•	•	•	•	•	•
Handle type										
Selector		•	•	•	•	•	—	—	—	—
Pistol		•	•	•	•	•	•	•	•	•
Conversion kits										
6 pole		•	•	•	•	•	•	•	•	•
Transfer		•	•	•	•	•	•	•	•	•
Bypass		•	•	•	•	•	•	•	•	•
Mechanical interlock		•	•	•	•	•	•	•	•	•
Electrical interlock		—	—	—	—	—	—	—	—	—

• = Available
 — = Not available

UL listed, CSA approved, IEC rated, CE marked

① UL listed switches are also CSA approved.
 ② For complete technical information please see page 58 & 59.
 ③ 1000V, IEC 408.
 ④ Switch only

Fusible

Non-Fused

Enclosed Fused

Enclosed Non-Fused

for Non-Fusible Disconnect Switches

BDNF200A – BDNF3150

Fusible

Non-Fused

Enclosed Fused

Enclosed Non-Fused

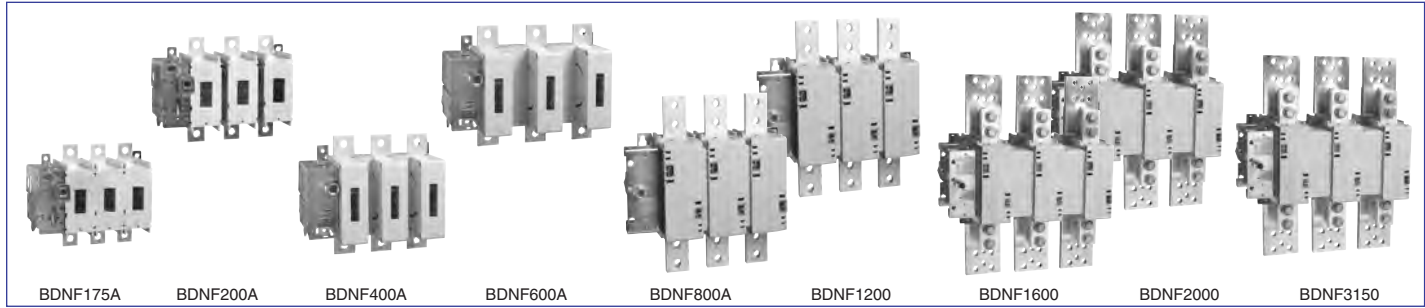

Catalog number	3 pole	BDNF175A	BDNF200A	BDNF400	BDNF600A	BDNF800A	BDNF1200	BDNF1600	BDNF2000	BDNF3150
General purpose amp rating	A	175	200	400	600	800	1200	1600	2000	3150
Approvals^①	2 pole 3 pole 4 pole	UL508 & IEC UL508 & IEC IEC	UL98 & IEC UL98 & IEC IEC	UL98 & IEC UL98 & IEC UL98 & IEC	UL98 & IEC UL98 & IEC UL98 & IEC	UL98 & IEC UL98 & IEC IEC	UL98 & IEC UL98 & IEC IEC	UL98 & IEC UL98 & IEC IEC	UL98 & IEC UL98 & IEC IEC	IEC IEC IEC
Technical ratings										
UL, CSA^②										
Max operating voltage	V	600	600	600	600	600	600	600	600	600
Max horsepower rating										
Three phase										
200 – 208V	HP	30	60	100	150	200	—	—	—	—
240V	HP	40	75	125	200	250	—	—	—	—
480V	HP	75	150	250	400	500	—	—	—	—
600V	HP	100	200	350	500	600	—	—	—	—
Single phase										
120V	HP	—	—	—	—	—	—	—	—	—
240V	HP	—	—	—	—	—	—	—	—	—
Technical ratings										
IEC^③										
Rated insulation and operational voltage. AC20 and DC20 ^④	V	1000	1000	1000	1000	1000	1000	1000	1000	1000
Rated thermal current, I _{th}										
AC 20/DC 20 open	A	200	315	630	800	1250	1600	2500	2500	3150
AC 20/DC 20 enclosed	A	200	270	630	720	1250	1600	2300	2300	2600
AC 21A 500V	A	200	250	630	800	1250	1600	2500	2500	3150
AC 21A 690V	A	200	250	630	800	1250	1600	2500	2500	3150
Rated operational power AC23										
400/415V	kW	90	132	315	355	400	400	400	400	400
690V	kW	170	200	355	355	—	—	—	—	—
Physical characteristics										
Weight ^④	3 pole lb	6.61	6.61	13.66	13.66	35.9	38.55	127.7	127.7	127.7
Dimension	3 pole H in	8.35	8.35	11.81	11.77	19.09	19.09	25.04	25.04	25.04
	W in	7.83	8.62	10.24	11.93	14.29	14.29	18.43	18.43	18.43
	D in	4.55	4.55	5.12	5.12	4.92	4.92	10.67	10.67	10.67
Accessories										
Terminal lug kit		BDTL25	BDTL25	BDTL26	BDTL27	BDTL30	BDTL28	BDTL28	BDTL28/2	BDTL28/2
Terminal shroud		•	•	•	•	•	•	—	—	—
Auxiliary contact		•	•	•	•	•	•	•	•	•
Handle UL/NEMA type										
Type 1, 3R, 12		•	•	•	•	•	•	•	•	•
Type 1, 3R, 4, 4X, 12		•	•	•	•	•	•	•	•	•
Handle type										
Selector		—	—	—	—	—	—	—	—	—
Pistol		•	•	•	•	•	•	•	•	•
Conversion kits										
6 pole		•	•	•	•	•	•	—	—	—
Transfer		•	•	•	•	•	•	—	—	—
Bypass		•	•	•	•	•	•	—	—	—
Mechanical interlock		•	•	•	•	•	•	•	•	•
Electrical interlock		•	•	•	•	•	•	•	•	•

S = Standard feature
• = Available
— = Not available

UL listed, CSA approved, IEC rated, CE marked

- ① UL listed switches are also CSA approved.
- ② For complete technical information please see page 58 & 59.
- ③ 1000V, IEC 408.
- ④ Switch only

for Non-Fusible Disconnect Switches
Base & DIN Rail Mounted

For a complete assembly,
please select one of each:

- 1 switch
- 1 handle
- 1 shaft



CDNF63



CDS85S



CDH3S



CDNF16
CDNF25
CDNF32



CDNF30
CDNF60
CDNF100



CDH1S



CDH15S



CDH6S



CDS_S

16 – 100 Amp switches, 600V, 3 pole^①

UL general purpose amp rating	IEC AC21 amp rating	Maximum horsepower rating						Terminal lugs		Catalog number
		Single phase		Three phase			Wire size	Wire type		
		120V	240V	200V	240V	480V			600V	
16	16	1/2	1.5	3	5	10	10	#18 – 8	Cu	CDNF16
25	25	3/4	2	7.5	7.5	15	20	#18 – 8	Cu	CDNF25
40	40	1	3	10	10	20	25	#18 – 8	Cu	CDNF32
60	63	2	5	15	15	30	20	#14 – 4	Cu	CDNF45
80	80	2	5	20	20	40	40	#14 – 1	Cu	CDNF63
30	40	2	5	10	10	20	30	#14 – 4	Cu	CDNF30
60	63	3	7.5	20	20	40	40	#14 – 4	Cu	CDNF60
100	115	5	15	25	25	50	40	#8 – 1/0	Cu	CDNF100

Selector handles — for use with shafts \square .20 x .20" (\square 5x5mm)

NEMA type	IEC type	Color	Defeatable	Padlockable	Weight (lbs)	Catalog number
All marked both O/I & Off/On						
1	IP54	Black	—	—	0.09	CDH1S ^②
1	IP54	Red/Yel	—	—	0.09	CDH2S ^②
1	IP54	Black	—	Yes	0.12	CDH15S ^②
1	IP54	Red/Yel	—	Yes	0.12	CDH16S ^②
1,3R,12	IP65	Black	—	Yes	0.16	CDH3S
1,3R,12	IP65	Red/Yel	—	Yes	0.16	CDH4S
1,3R,12	IP65	Black	Yes	Yes	0.16	CDH5S
1,3R,12	IP65	Red/Yel	Yes	Yes	0.16	CDH6S

Shafts — for use with CDH selector handles \square .20 x .20" (\square 5x5mm)

Shaft length inches/mm	Mounting depth ^③ in inches					Weight (lbs)	Catalog number
	CDNF16 CDNF25 CDNF32		CDNF45 CDNF63		CDNF30 CDNF60 CDNF100		
	CDH1S, CDH2S CDH15S, CDH16S	CDH3S, CDH4S CDH5S, CDH6S	CDH1S, CDH2S CDH15S, CDH16S	CDH3S, CDH4S CDH5S, CDH6S	CDH3S, CDH4S CDH5S, CDH6S		
3.3/85	4.2 – 5.0	3.6 – 4.3	4.9 – 5.6	4.4 – 5.0	3.9 – 4.9	0.04	CDS85S
4.1/105	5.0 – 5.8	4.4 – 5.1	5.7 – 6.4	5.1 – 5.8	4.7 – 5.7	0.04	CDS105S
4.7/120	5.6 – 6.4	5.0 – 5.8	6.3 – 7.0	5.7 – 6.4	5.3 – 6.3	0.05	CDS120S
5.1/130	6.0 – 6.7	5.4 – 6.1	6.7 – 7.4	6.1 – 6.8	5.6 – 6.7	0.05	CDS130S
7.1/180	7.1 – 8.7	7.4 – 8.1	8.6 – 9.4	8.1 – 8.7	7.6 – 8.6	0.08	CDS180S
9.8/250	10.7 – 11.5	10.1 – 10.8	11.4 – 12.1	10.9 – 11.5	10.4 – 11.4	0.10	CDS250S
13/330	13.8 – 14.6	13.3 – 14.0	14.6 – 15.3	14.0 – 14.7	13.5 – 14.5	0.14	CDS330S

① A snap on fourth pole may be added

② Not suitable for use with CDNF30, 60, 100.

③ Mounting depth is the distance from the outside of door to the disconnect switch mounting plate. Shaft can be cut to desired length.

Fusible

Non-Fused

Enclosed Fused

Enclosed Non-Fused

for 16A – 100A Non-Fusible Disconnect Switches Base & DIN Rail Mounted

Fusible

Non-Fused

Enclosed Fused

Enclosed Non-Fused

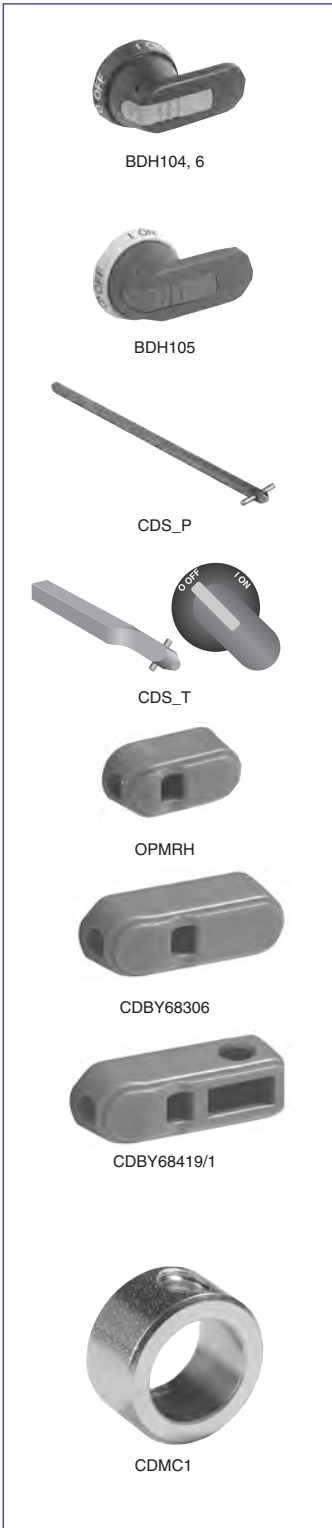

Pistol handles — for use with shafts $\square .20 \times .20"$ ($\square 5 \times 5 \text{ mm}$)

NEMA type	IEC type	Color	Marking	Length inches/mm	Defeatable	Padlockable	Weight (lbs.)	Catalog number
1,3R,12	IP65	Black	O/I & Off/On	1.8/45	Yes	Yes	0.28	BDH104
1,3R,12	IP65	Red/Yel	O/I & Off/On	1.8/45	Yes	Yes	0.28	BDH105
1,3R,12	IP65	Black	O/I & Off/On	2.6/65	Yes	Yes	0.29	BDH106
1,3R,12	IP65	Red/Yel	O/I & Off/On	2.6/65	Yes	Yes	0.29	BDH107
1,3R,12,4,4X	IP66	Black	O/I & Off/On	2.6/65	Yes	Yes	0.29	CDHXB65
1,3R,12,4,4X	IP66	Red/Yel	O/I & Off/On	2.6/65	Yes	Yes	0.29	CDHXY65

Shafts — for use with pistol handles $\square .20 \times .20"$ ($\square 5 \times 5 \text{ mm}$)



Shaft length (inches/mm)	Mounting depth ^① in inches			Weight (lbs.)	Catalog number
	CDNF16 CDNF25 CDNF32	CDNF45 CDNF63	CDNF30 CDNF60 CDNF100		
5.9/150	6.2 – 6.7	6.9 – 7.4	6.4 – 7.4	0.07	CDS48P
6.7/170	7.0 – 7.5	7.7 – 8.1	7.2 – 8.1	0.08	CDS67P
10.4/265	10.7 – 11.3	11.4 – 11.9	10.9 – 11.9	0.12	CDS49P
15.8/400	16.0 – 16.6	16.8 – 17.2	16.2 – 17.2	0.18	CDS50P
19.7/500	20.0 – 20.5	20.7 – 21.1	20.1 – 21.1	0.23	CDS99P

Twisted shafts — Rotates handle 45° $\square .20 \times .20"$ ($\square 5 \times 5 \text{ mm}$)



Shaft length (inches/mm)	Mounting depth ^① in inches			Weight (lbs.)	Catalog number
	CDNF16 CDNF25 CDNF32	CDNF45 CDNF63	CDNF30 CDNF60 CDNF100		
5.9/150	6.2 – 6.7	6.9 – 7.4	6.4 – 7.4	0.07	CDS48T
6.7/170	7.0 – 7.5	7.7 – 8.1	7.2 – 8.1	0.08	CDS67T
10.4/265	10.7 – 11.3	11.4 – 11.9	10.9 – 11.9	0.12	CDS49T
15.8/400	16.0 – 16.6	16.8 – 17.2	16.2 – 17.2	0.18	CDS50T

Replacement knob — mounts directly to switch; no shaft necessary

NEMA Type	Color	For use on:	Length (inches)	Padlockable	Catalog number
1	Red	CDNF16, 25, 32	1.0	—	OPMRH
1	Red	CDNF30, 45, 60, 63, 100	1.4	—	CDBY68306 ^③
1	Red	CDNF30, 45, 60, 63, 100	1.6	Yes ^②	CDBY68419/1 ^③
Metal collar		CDNF16 – CDNF100	—	—	CDMC1
Set screw		CDNF16, 25, 30, 32, 45, 60, 63, 100	—	—	CDSWM5X8

① Mounting depth is the distance from the outside of door to the disconnect switch mounting plate. Shaft can be cut to desired length.
 ② .1875" (3/16") diameter shackle required.
 ③ Set screw CDSWM5X8 needed with replacement knobs CDBY__.

for 16A – 100A Non-Fusible Disconnect Switches Base & DIN Rail Mounted

Base and DIN rail mounted switches

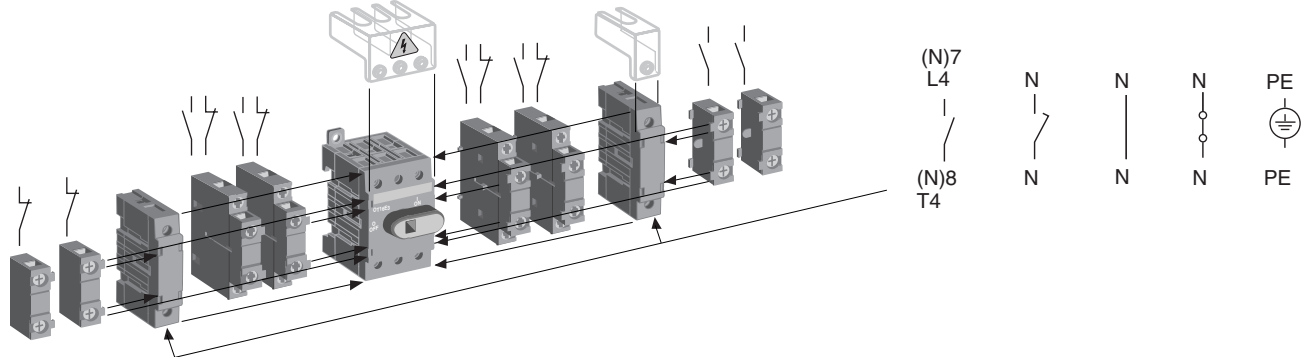

Auxiliary contacts^① — snap-on mounting

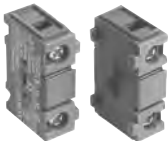

CDAUX

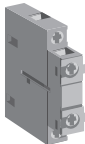

CDAUX11

Description	For use on:	Weight (lbs.)	AC thermal amp rating	AC rated voltage	Catalog number
1 N.O. mounts on right hand side of switch only	CDNF16 – CDNF100	0.07	10	600	CDAUX10
1 N.C. mounts on left hand side of switch only	CDNF16 – CDNF100	0.07	10	600	CDAUX01
1 N.O. + 1 N.C. mounts on left or right hand side of switch	CDNF16 – CDNF100	0.07	10	600	CDAUX11

Max. two contacts on each side of switch

Power poles

- Only one power pole per switch
- Mounts on left or right side of switch



CD_32P

Description	For use on:	Weight (lbs.)	AC thermal amp rating	AC rated voltage	Catalog number
Fourth pole ^②	CDNF16 – CDNF100	0.07	40	600	CDS32P
		0.13	80	600	CDS63P
		0.31	100	600	CDS125P
Late-break/early-make ^②	CDNF16 – CDNF100	0.07	40	600	CDL32P
		0.13	80	600	CDL63P
		0.31	100	600	CDL125P

Terminal poles

- Switch accepts one terminal pole per side
- Mounts on left or right side of switch



CD_63P

Description	For use on:	Weight (lbs.)	AC thermal amp rating	AC rated voltage	Catalog number
Solid neutral ^②	CDNF16 – CDNF100	0.07	40	600	CDN32P
		0.13	80	600	CDN63P
		0.31	100	600	CDN125P
Detachable neutral ^②	CDNF16 – CDNF100	0.07	40	600	CDD32P
		0.13	80	600	CDD63P
		0.31	100	600	CDD125P
Ground terminal ^②	CDNF16 – CDNF100	0.07	40	600	CDE32P
		0.13	80	600	CDE63P
		0.31	100	600	CDE125P

① UL File # E83510

② Switch accepts one power pole or one terminal pole per side. Only one power pole per switch.



CD_125P

Fusible

Non-Fused

Enclosed Fused

Enclosed Non-Fused

for 16A – 100A Non-Fusible Disconnect Switches

Base & DIN Rail Mounted

Fusible

Non-Fused

Enclosed Fused

Enclosed Non-Fused

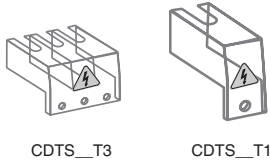

CDTS_T3

CDTS_T1



CDSA1

CDSA2



CDTL-ST

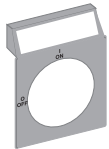

CDP_2

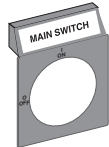

CDP_2EN1

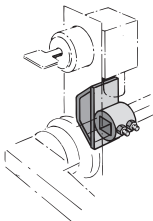

CDETL-ZW16

NDNA100
NDNA200

Terminal shrouds* — snap on mounting for line or load side

Description	For use on:	Weight (lbs.)	Catalog number
3 pole includes one shroud for line or load side	CDNF16, CDNF25, CDNF32, CDNF45, CDNF63, CDNF30, CDNF60, CDNF100	0.02 0.02 0.02	CDTS32T3 CDTS63T3 CDTS125T3
4th pole includes one shroud for line or load side	CD_32P CD_63P CD_125P	0.02 0.02 0.02	CDTS32T1 CDTS63T1 CDTS125T1

* All disconnects are IP20 touch safe as standard. Terminal shrouds provide an additional level of protection.

Padlocking adapter

Description	For use on:	Weight (lbs.)	Catalog number
Adapter for one padlock with a max. 0.137" shackle	CDNF30, CDNF45 CDNF60, CDNF63 CDNF100	0.02	CDSA1
Padlock for DS-SA1		0.22	CDSA2
Adapter and padlock		0.24	CDSA3

Labelling accessories

Description	For use on:	Package quantity	Catalog number
1 Pkg. of label carriers	CDNF30, CDNF45 CDNF60, CDNF63 CDNF100	100 pieces	CDTL-ST
1 Pkg of blank description labels		315 pieces	CDT-E

Legend plates for selector handles

Description	For use on:	Catalog number
Blank plate Black Yellow Black Yellow	CDH15, 25, 75, 85, 115, 125 155, 165, 175, 185, 195, 205	CDPB1 CDPY1 CDPB2 CDPY2
	CDH35, 45, 55, 65, 95, 105, 135, 145	
Plate marked with: MAIN SWITCH Black Yellow Black Yellow	CDH15, 25, 75, 85, 115, 125 155, 165, 175, 185, 195, 205	CDPB1EN1 CDPY1EN1 CDPB2EN1 CDPY2EN1
	CDH35, 45, 55, 65, 95, 105, 135, 145	

Locking accessories

Description	For use on:	Weight (lbs.)	Catalog number
Cam attachment for Kirk Key, Castell, Lowe & Fletcher and Ronis interlock. For adapting to the interlock system. The interlock is not included.	5, 6 & 8mm shafts	0.29	CDETL-ZW16

DIN rail

Description	For use on:	Weight (lbs.)	Length inches/mm	Catalog number
35mm DIN Rail	CDNF16 – CDNF100	.38	39.4/1000	NDNA100
35mm Aluminum DIN Rail	CDNF16 – CDNF100	.75	78.8/1000	NDNA200

Shaft support

Description	For use on:	Weight (lbs.)	Catalog number
Shaft support	CDNF16 – CDNF100	0.30	CDTL-ZX58

for 16A – 100A Non-Fusible Disconnect Switches Base & DIN Rail Mounted

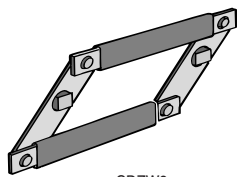

CDZW8

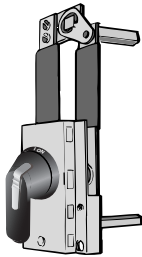

CDZW6

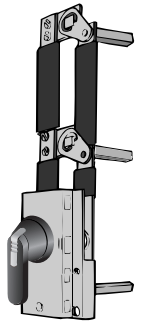

CDZW17

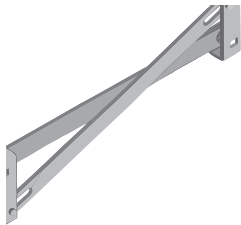

CDZW24

Conversion mechanisms

- For use with Base and DIN rail mounted switches only
- Switches are not included

Description	For use on:	Weight (lbs.)	Catalog number
6 or 8 pole	CDNF16 – CDNF100	0.33	CDZW8
Transfer		1.87	CDZW6
Bypass		1.54	CDZW17

6 or 8 pole — CDZW8

6 (8) pole mechanism allows two switches controlled by one handle to open or close simultaneously.

Equipment required for a complete installation:

- One conversion mechanism
- Two disconnect switches
- One handle^①
- One 5mm shaft

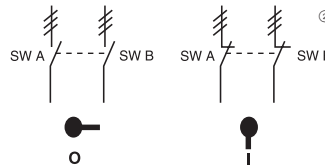

	POS. O	POS. I
SW. A	O	X
SW. B	O	X

X = Closed
O = Open

Transfer — CDZW6

Transfer mechanism manually transfers between two power sources using two switches and a center OFF position.

A 3-position handle is included:

(UL Type 1, 3R & 12) or (UL Type 1, 3R, 4, 4X, 12)

Shafts included. Equipment required for a complete installation:

- One conversion mechanism
- Two disconnect switches

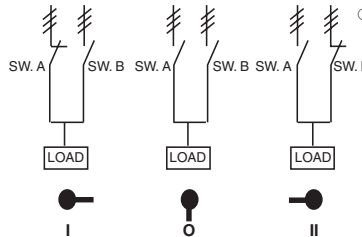

	POS. I	POS. O	POS. II
SW. A	X	O	O
SW. B	O	O	X

X = Closed
O = Open

Bypass — CDZW17

Bypass mechanism operates three switches: Two switches in series and one changeover switch to allow power bypass.

A 3-position handle is included:

(UL Type 1, 3R & 12) or (UL Type 1, 3R, 4, 4X, 12)

Shafts included. Equipment required for a complete installation:

- One conversion mechanism
- Three disconnect switches

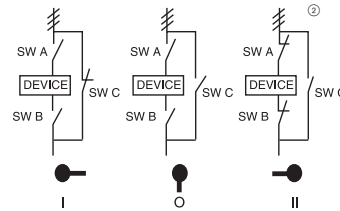

	POS. I	POS. O	POS. II
SW. A	O	O	X
SW. B	O	O	X
SW. C	X	O	O

X = Closed
O = Open

Mechanical interlock — CDZW24

Mechanical interlock mechanism prevents both switches from being in the ON position at the same time.

Equipment required for a complete installation:

- One conversion mechanism
- Two disconnect switches
- Two handles
- Two shafts



	SW. A POS. I	SW. B POS. I
SW. A	X	O
SW. B	O	X

X = Closed
O = Open

① CDNF16 – CDNF32 can use a selector or pistol handle. All other sizes must use a pistol handle.

② = Three poles

Fusible

Non-Fused

Enclosed Fused

Enclosed Non-Fused

Non-Fusible Disconnect Switches

Door Mounted

For a complete assembly, please order one of each:

- 1 switch
- 1 handle



CDNF45D

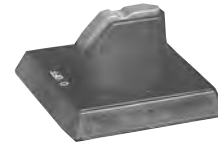

CDH9S

Fusible

Non-Fused

Enclosed Fused

Enclosed Non-Fused



CDNF16
CDNF25
CDNF32



CDH8S
CDH12S



CDH17S
CDH19S



CDH9S
CDH13S



CDH10S
CDH14S

16 – 100 Amp switches, 600V, 3 pole^{①②③}

UL general purpose amp rating	IEC AC21 amp rating	Maximum horsepower rating						Terminal lugs		Catalog number
		Single phase		Three phase				Wire size	Wire type	
		120V	240V	200V	240V	480V	600V			
16	16	1/2	1.5	3	5	10	10	#18 – 8	Cu	CDNF16D
25	25	3/4	2	7.5	7.5	15	20	#18 – 8	Cu	CDNF25D
40	40	1	3	10	10	20	25	#18 – 8	Cu	CDNF32D
60 ^④	63	2	5	15	15	30	20	#14 – 4	Cu	CDNF45D
80 ^④	80	2	5	20	20	40	40	#14 – 1	Cu	CDNF63D
30 ^④	40	2	5	10	10	20	30	#14 – 4	Cu	CDNF30D
60 ^④	63	3	7.5	20	20	40	40	#14 – 4	Cu	CDNF60D
100 ^④	115	5	15	25	25	50	40	#8 – 1/0	Cu	CDNF100D

Selector handles

NEMA/UL type	IEC type	Color	Defeatable	Padlockable	Weight (lbs)	Catalog number
--------------	----------	-------	------------	-------------	--------------	----------------

All marked both O/I & Off/On

Snap-on mounting — for use on CDNF16, 25, 32D

NEMA/UL type	IEC type	Color	Defeatable	Padlockable	Weight (lbs)	Catalog number
1	IP54	Black	—	—	0.10	CDH7S
1	IP54	Red/Yel	—	—	0.10	CDH8S
1	IP54	Black	—	Yes	0.13	CDH19S
1	IP54	Red/Yel	—	Yes	0.13	CDH20S
1,3R,12	IP65	Black	—	Yes	0.17	CDH9S
1,3R,12	IP65	Red/Yel	—	Yes	0.17	CDH10S

Screw mounting — for use on CDNF16, 25, 32, 45 & 63D

NEMA/UL type	IEC type	Color	Defeatable	Padlockable	Weight (lbs)	Catalog number
1	IP54	Black	—	—	0.11	CDH11S
1	IP54	Red/Yel	—	—	0.11	CDH12S
1	IP54	Black	—	Yes	0.14	CDH17S
1	IP54	Red/Yel	—	Yes	0.14	CDH18S
1,3R,12	IP65	Black	—	Yes	0.18	CDH13S
1,3R,12	IP65	Red/Yel	—	Yes	0.18	CDH14S

Door mounted switches do not provide door interlock

Pistol grip handle adapter

Description	For use on:	Weight (lbs)	Catalog number
Adapter piece for pistol grip handle	CDNF30, CDNF60, CDNF100	0.18	CDHZX6

- ① A snap on fourth pole may be added
- ② Door mounted switches do not require shafts.
- ③ CDNF16, 25, 32, 45 & 63 door mounted switches will not accept pistol handles.
- ④ CDNF45 & 63 door mounted switches can only use screw mounted handles.

for 16A – 100A Non-Fusible Disconnect Switches

Door Mounted

Door mounted switches

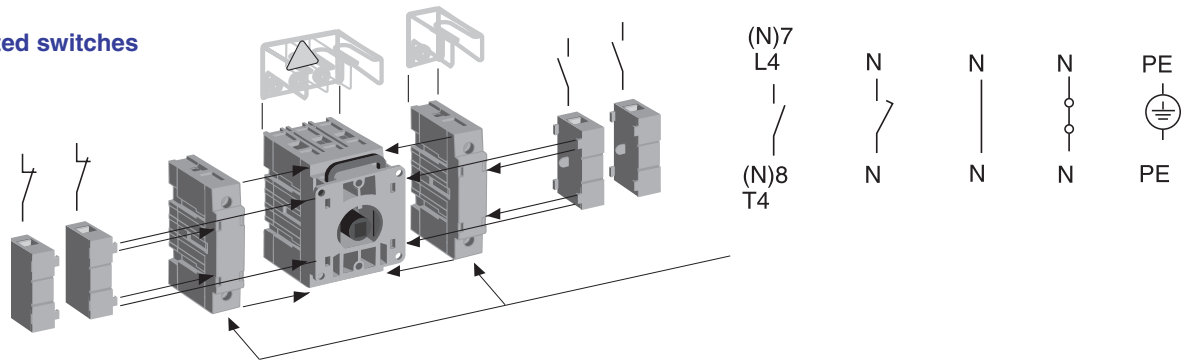

Fusible

Non-Fused

Enclosed Fused

Enclosed Non-Fused

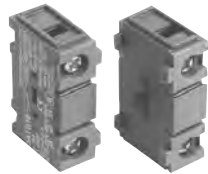

CDAUX_

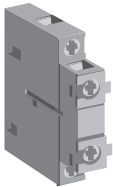

CDAUX11



CD_32D



CD_63D

Auxiliary contacts^① — snap-on mounting

Description	For use on:	Weight (lbs)	AC thermal amp rating	AC rated voltage	Catalog number
1 N.O. mounts on righthand side of switch	CDNF16D - CDNF100D	0.07	10	600	CDAUX10
1 N.C. mounts on lefthand side of switch		0.07	10	600	CDAUX01
1 N.O. + 1 N.C. mounts on left or right hand side of switch		0.07	10	600	CDAUX11

Max. two contacts on each side of switch

Power poles

- Only one power pole per switch
- Mounts on left or right side of switch

Description	For use on:	Weight (lbs)	AC thermal amp rating	AC rated voltage	Catalog number
Fourth pole ^②	CDNF16D, CDNF25D, CDNF32D	0.07	40	600	CDS32D
	CDNF45D, CDNF63D	0.13	80	600	CDS63D
	CDNF30D, CDNF60D, CNDNF100D	0.20	100		CDS100D
Late-break/early-make ^②	CDNF16D, CDNF25D, CDNF32D	0.07	40	600	CDL32D
	CDNF45D, CDNF63D	0.13	80	600	CDL63D
	CDNF30D, CDNF60D, CNDNF100D	0.20	100		CDL100D

Terminal poles

- Switch accepts one terminal pole per side
- Mounts on left or right side of switch

Description	For use on:	Weight (lbs)	AC thermal amp rating	AC rated voltage	Catalog number
Solid neutral ^②	CDNF16D, CDNF25D, CDNF32D	0.07	40	600	CDN32D
	CDNF45D, CDNF63D	0.13	80	600	CDN63D
	CDNF30D, CDNF60D, CNDNF100D	0.20	100		CDN100D
Detachable neutral ^②	CDNF16D, CDNF25D, CDNF32D	0.07	40	600	CDD32D
	CDNF45D, CDNF63D	0.13	80	600	CDD63D
	CDNF30D, CDNF60D, CNDNF100D	0.20	100		CDD100D
Ground terminal ^②	CDNF16D, CDNF25D, CDNF32D	0.07	40	600	CDE32D
	CDNF45D, CDNF63D	0.13	80	600	CDE63D
	CDNF30D, CDNF60D, CNDNF100D	0.20	100		CDE100D

① UL File # E83510

② Switch accepts one power pole or one terminal pole per side. Only one power pole per switch.

for 16A – 100A Non-Fusible Disconnect Switches

Door Mounted

Fusible

Non-Fused

Enclosed Fused

Enclosed Non-Fused

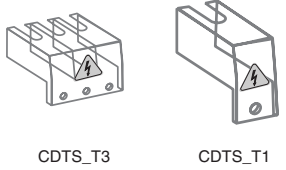

Terminal shrouds* — snap-on mounting for line or load side

Description	For use on:	Weight (lbs)	Catalog number
3 pole includes one shroud for line or load side	CDNF16D, 25D, 32D	0.02	CDTS32T3 CDTS63T3 CDTS100T3
	CDNF45D & 63D	0.02	
	CDNF30D, 60D, 100D	0.02	
4 pole includes one shroud for line or load side	CD_32D	0.02	CDTS32T1 CDTS63T1 CDTS100T1
	CD_63D	0.02	
	CD_100D	0.02	

* All disconnects are IP20 touch safe as standard. Terminal shrouds provide an additional level of protection.

Legend plates for selector handles

Description	For use on:	Catalog number
Blank plate	CDH15, 25, 75, 85, 115, 125 155, 165, 175, 185, 195, 205	CDPB1
		CDPY1
	CDH35, 45, 55, 65, 95 105, 135, 145	CDPB2
		CDPY2
Plate marked with: MAIN SWITCH	CDH15, 25, 75, 85, 115, 125 155, 165, 175, 185, 195, 205	CDPB1EN1
		CDPY1EN1
	CDH35, 45, 55, 65, 95 105, 135, 145	CDPB2EN1
		CDPY2EN1

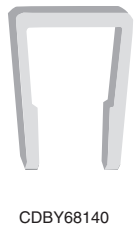
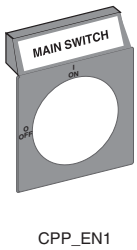
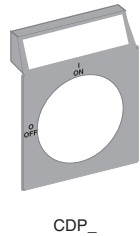

Locking clip (replacement part)

Description	For use on:	Catalog number
Door mounted switch handle locking clip	CDNF16D CDNF25D CDNF32D	CDBY68140

Non-Fusible Disconnect Switches

For a complete assembly, please select one of each:

- 1 switch
- 1 handle
- 1 shaft



CDNF160



BDS210



BDH60

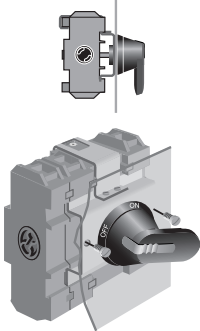

CDNF160D



BDH60



BDH61



BDS_

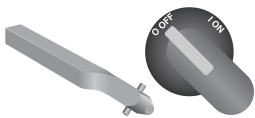

BDST_

125 Amp Base & DIN rail mounted switches^①, 600V

UL general purpose amp rating	IEC AC21 amp rating	Maximum horsepower rating					Terminal lugs		Catalog number
		Three phase					Wire size	Wire type	
		200V	208V	240V	480V	600V			
2 pole 125	160	—	—	—	—	—	#8 – 1/0	Cu	CDNF160-2
3 pole 125	160	30	30	30	60	75	#8 – 1/0	Cu	CDNF160

125 Amp Door mounted switch^①, 600V, 3 pole

UL general purpose amp rating	IEC AC21 amp rating	Maximum horsepower rating					Terminal lugs		Catalog number
		Three phase					Wire size	Wire type	
		200V	208V	240V	480V	600V			
125	160	30	30	30	60	75	#8 – 1/0	Cu	CDNF160D

Pistol handles — for use with □ .24 x .24" (□ 6 x 6 mm)

NEMA type	IEC type	Color	Length in/mm	Marking	Defeat-able	Padlock-able	Weight (lbs)	Catalog number
1, 3R, 12	IP65	Black	2.6/65	O/I & Off/On	Yes	Yes	0.29	BDH58
1, 3R, 12	IP65	Red/Yel	2.6/65	O/I & Off/On	Yes	Yes	0.29	BDH59
1, 3R, 12	IP65	Black	3.1/80	O/I & Off/On	Yes	Yes	0.30	BDH60
1, 3R, 12	IP65	Red/Yel	3.1/80	O/I & Off/On	Yes	Yes	0.30	BDH61
1, 3R, 4, 4X, 12	IP66	Black	3.1/80	O/I & Off/On	Yes	Yes	0.30	CDHXB86
1, 3R, 4, 4X, 12	IP66	Red/Yel	3.1/80	O/I & Off/On	Yes	Yes	0.30	CDHXY86

Shafts — for use with pistol handles □ .24 x .24" (□ 6 x 6 mm)

Shaft length inches/mm		Mounting depth ^② in inches	Weight (lbs)	Catalog number
5.2/130		4.3 – 6.0	0.08	BDS130
5.9/150		5.0 – 6.7	0.09	BDS150
8.3/210		7.4 – 9.1	0.13	BDS210
11.4/290		10.5 – 12.2	0.18	BDS290
14.2/360		13.3 – 15.0	0.23	BDS360
16.9/430		16.0 – 17.8	0.27	BDS430

Twisted shafts — Rotates handle 45° □ .24 x .24" (□ 6 x 6 mm)

Shaft length inches/mm		Mounting depth ^② in inches	Weight (lbs)	Catalog number
5.2/130		4.3 – 6.0	0.08	BDST4
8.3/210		7.4 – 9.1	0.13	BDST25
11.4/290		10.5 – 12.2	0.18	BDST29
14.2/360		13.3 – 15.0	0.23	BDST30

① A snap on fourth pole may be added

② Mounting depth is the distance from the outside of the door to the disconnect switch mounting plate. Shaft can be cut to desired length.

Fusible

Non-Fused

Enclosed Fused

Enclosed Non-Fused

for 125A Non-Fusible Disconnect Switches

Fusible

Non-Fused

Enclosed Fused

Enclosed Non-Fused

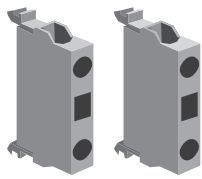

CDAUXCA10 CDAUXCA01

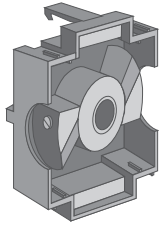

CDAUXB160



CDAUX16011 CDMB160

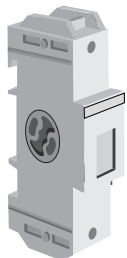

CD_160P

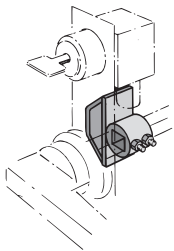

CDETL-ZW16

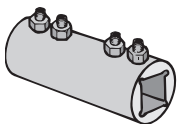

BDZX167
BDZX95

Auxiliary contacts, top mounted

- Accepts four contacts maximum, mounting base always required

Description	For use on:	Weight (lbs)	AC thermal amp rating	AC rated voltage	Catalog number
1 N.O. 1 N.C.	CDNF160	0.07	10 10	600 600	CDAUXCA10 CDAUXCA01
1 N.O. gold plated ^① 1 N.C. gold plated ^①	CDNF160	0.07	10 10	600 600	CDEA-10AU CDEA-01AU
Mounting base – required for CDAUX_	CDAUX_	0.06	—	—	CDAUXB160

Auxiliary contacts, side mounted

- Accepts four contacts maximum

Description	For use on:	Weight (lbs)	AC thermal amp rating	AC rated voltage	Catalog number
1 N.O. & 1 N.C.	CDNF160	0.07	10	600	CDAUX16011
Mounting base, required for CDAUX16011	CDNF160	0.06	—	—	CDMB160

Max. two contacts on each side of switch. One mounting base required for each side of switch

Numbering stickers^②

Description	For use on:	Package qty.	Catalog number
1 Pkg. of blank labels for OBEA-10, 1 N.O.	CDNF160	10	CDEA-ZX10
1 Pkg. of blank labels for OBEA-01, 1 N.C.	CDNF160	10	CDEA-ZX01

Power pole — for use with base or door mounted switch

- Only one power pole per switch
- Mounts on left or right side of switch

Description	For use on:	Weight (lbs)	AC thermal amp rating	AC rated voltage	Catalog number
Fourth pole	CDNF160	0.66	125	600	CDS160P

Terminal poles — for use with base or door mounted switch

- Switch accepts one terminal pole per side
- Mounts on left or right side of switch

Description	For use on:	Weight (lbs)	AC thermal amp rating	AC rated voltage	Catalog number
Detachable neutral mounts on side of switch or DIN rail	CDNF160	0.66	125	600	CDN160P
Ground terminal	CDNF160	0.66	125	600	CDE160P

Locking accessories

Description	For use on:	Weight (lbs)	Catalog number
Cam attachment for Kirk Key, Castell, Lowe & Fletcher and Ronis interlock. For adapting to the interlock system. The interlock is not included.	5, 6 & 8mm shafts	0.29	CDETL-ZW16

Handle support bracket

Description	For use on:	Weight (lbs)	Catalog number
Allows pistol handle to be directly mounted to switch behind the door	CDNF160	0.33	CDZX5

Shaft extension couplers

Description	For use on:	Weight (lbs)	Catalog number
Joins two shafts together for applications where extended length is required	for 6mm shafts for 12mm shafts	0.26 0.26	BDZX167 BDZX95

① Type _AU for low energy applications. The contacts are gold-plated. AC & DC ratings — Maximum: A600 & P600. Minimum: 12V, 1mA; 5V, 2mA

② Required if several contact blocks are used in the same installation.

for 125A Non-Fusible Disconnect Switches



Conversion mechanisms

- For use with Base and Din rail mounted switches only
- Switches are not included

Description	For use on:	Weight (lbs.)	Catalog number
6 or 8 pole	CDNF160	1.52	BDZW2
Transfer (1, 3R, 12)		2.20	BDZW1
Transfer (4X)		2.20	BDZW1X
Mechanical interlock		0.55	CDZW10

6 or 8 pole — BDZW2

6 (8) pole mechanism allows two switches controlled by one handle, to open or close simultaneously. Shafts included.

Equipment required for a complete installation:

- One conversion mechanism
- Two disconnect switches
- One handle

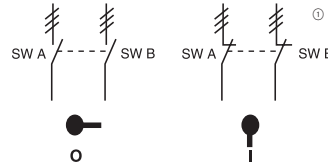

	POS. O	POS. I
SW. A	O	X
SW. B	O	X

X = Closed
O = Open

Transfer — BDZW1

Transfer mechanism manually transfers between two power sources using two switches and a center OFF position. A 3 position handle is included. (UL Type 1, 3R & 12) or (UL Type 1, 3R, 4, 4X, 12) Shafts included. Equipment required for a complete installation:

- One conversion mechanism
- Two disconnect switches

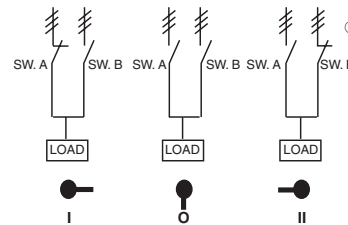

	POS. I	POS. O	POS. II
SW. A	X	O	O
SW. B	O	O	X

X = Closed
O = Open

Mechanical interlock — CDZW10

Mechanical interlock mechanism prevents both switches from being in the ON position at the same time.

Equipment required for a complete installation:

- One conversion mechanism
- Two disconnect switches
- Two handles
- Two shafts

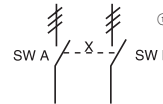

	SW. A POS. I	SW. B POS. I
SW. A	X	O
SW. B	O	X

X = Closed
O = Open

Shaft adapter

Description	For use on:	Weight (lbs)	Catalog number
Adapts one end of a 5 or 6mm shaft to 12mm Use with shaft extension coupler	5 & 6mm shafts	0.20	CDZK19

Power pole interlock (replacement part)

Description	For use on:	Weight (lbs)	Catalog number
Interlocks a power pole with an adjacent power pole	CDNF160	0.05	CDBY68005

Replacement collar (optional replacement for knob)

Description	For use on:	Weight (lbs)	Catalog number
Red knob (like original) for locking shaft in place ** re-use original set screw **	CDNF160	0.05	CXBY68100
Replaces original red knob for locking shaft in place ** re-use original set screw **	CDNF160	0.05	CDMC2

① ≡ = Three poles

Fusible

Non-Fused

Enclosed Fused

Enclosed Non-Fused

for Non-Fusible Disconnect Switches

For a complete assembly, please select one of each:

- 1 switch
- 1 handle
- 1 shaft
- 1 terminal lug kit

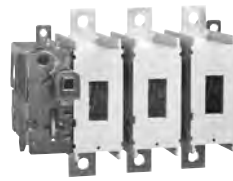

BDNF200A



BDS240



BDH110



BDTL25

Fusible

Non-Fused

Enclosed Fused

Enclosed Non-Fused

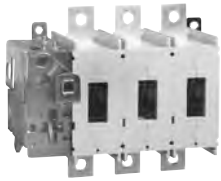

BDNF175A



BDH108



BDH109



BDS__

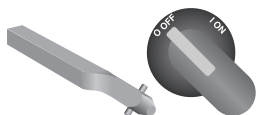

CDS340T

175 – 200 Amp switches, 600V

UL general purpose amp rating	IEC AC21 Amp rating	Maximum horsepower rating					Catalog number
		Three phase					
		200V	208V	240V	480V	600V	
2 pole	175	250	—	—	—	—	BDNF175A2 BDNF200A2
	200	250	—	—	—	—	
3 pole	175	250	30	30	40	75	BDNF175A BDNF200A
	200	250	60	60	75	150	
4 pole	175	250	30	30	40	75	BDNF175A4 BDNF200A4
	200	250	60	60	75	150	

Pistol handles — for use with shafts □ .31 x .31" (□ 8 x 8mm)

NEMA type	IEC type	Color	Length mm	Marking	Defeatable	Padlockable	Weight (lbs)	Catalog number
1,3R,12	IP65	Black	2.6/65	O/I & Off/On	Yes	Yes	0.29	BDH108
1,3R,12	IP65	Red/Yellow	2.6/65	O/I & Off/On	Yes	Yes	0.29	BDH109
1,3R,12	IP65	Black	3.1/80	O/I & Off/On	Yes	Yes	0.30	BDH110
1,3R,12	IP65	Red/Yellow	3.1/80	O/I & Off/On	Yes	Yes	0.30	BDH111
1,3R,4,4X,12	IP66	Black	3.1/80	O/I & Off/On	Yes	Yes	0.30	CDHXB88
1,3R,4,4X,12	IP66	Red/Yellow	3.1/80	O/I & Off/On	Yes	Yes	0.30	CDHXY88

Shafts — for use with pistol handles □ .31 x .31" (□ 8 x 8mm)

Shaft length inches/mm		Mounting depth ^① in inches BDNF175A – BDNF200A	Weight (lbs)	Catalog number
5.5/140		4.7 – 8.7	0.15	BDS140
9.5/240		8.7 – 12.6	0.26	BDS240
13.4/340		12.6 – 16.6	0.36	BDS340
19.5/500		18.9 – 22.9	0.54	BDS500

Twisted shafts — Rotates handle 45° □ .31 x .31" (□ 8 x 8mm)

Shaft length inches/mm		Mounting depth ^① in inches BDNF175A – BDNF200A	Weight (lbs)	Catalog number
13.4/340		12.6 – 16.6	0.36	CDS340T

① Mounting depth is the distance from the outside of the door to the disconnect switch mounting plate. Shaft can be cut to desired length.
 ② Availability to be announced.

for 175A – 200A Non-Fusible Disconnect Switches



BDTL25



BDTL175

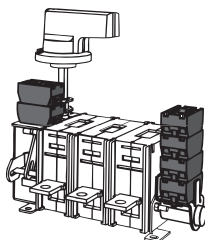

BDAUX12, 13

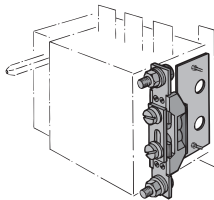

BDZX129

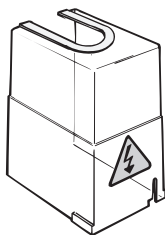

BDTS2

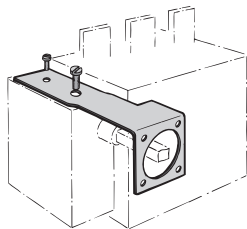

BDZX131

Terminal lug kits

For use on:	Wire size	Kit weight (lbs.)	Wire type	Terminal lugs per kit	Catalog number
BDNF175A & BDNF200A	#6 – 300 kcmil	0.93	Cu/Al	6	BDTL25
	#6 – 300 kcmil	0.47	Cu/Al	3	BDTL253P
	*(6) #14 – 6	0.55	Cu/Al	3	BDTL175

*A load side distribution lug eliminates the need to purchase, install and wire a separate distribution block.

Auxiliary contacts®

Description*	For use on:	Weight (lbs)	AC thermal amp rating	AC rated voltage	Catalog number
1 N.O. + 1 N.C.	BDNF175A BDNF200A	0.09	10	600	BDAUX12
2 N.O. + 2 N.C.		0.18	10	600	BDAUX13
4 N.O. + 4 N.C.		0.35	10	600	BDAUX16
2 N.O.		0.09	10	600	BDAUX14
4 N.O.		0.18	10	600	BDAUX15
8 N.O.		0.35	10	600	BDAUX17

*Contact configuration when mounted on switch, not shelf state.

Terminal poles

Description	For use on:	Weight (lbs)	AC thermal amp rating	AC rated voltage	Catalog number
Detachable neutral mounts on side of switch or DIN rail	BDNF175A BDNF200A	0.84	200	600	BDZX129

Terminal shrouds

Description	For use on:	Weight (lbs)			Catalog number
Includes one set of 3 shrouds for use on line or load side	BDNF175A BDNF200A	0.40			BDTS2

Handle support bracket

Description	For use on:	Weight (lbs)			Catalog number
Allows handle to be directly mounted to switch behind the door	BDNF175A BDNF200A	0.33			BDZX131

① UL File E57057 _____

Fusible

Non-Fused

Enclosed Fused

Enclosed Non-Fused

for 175A – 200A Non-Fusible Disconnect Switches

Fusible

Non-Fused

Enclosed Fused

Enclosed Non-Fused

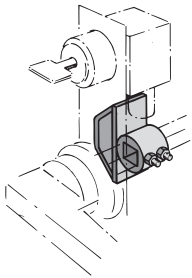

CDETL-ZW16

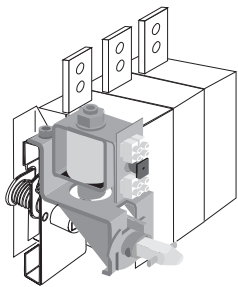

CDETL-ZT 80A

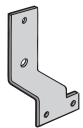

CDETL-ZT140

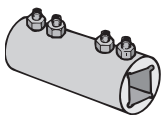

BDZW95

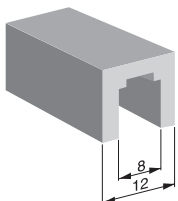

CDZT123

Locking accessories

Description	For use on:	Weight (lbs.)	Catalog number
Cam attachment for Kirk Key, Castell, Lowe & Fletcher and Ronis interlock. For adapting to the interlock system. The interlock is not included.	5, 6 & 8mm shafts	0.29	CDETL-ZW16
Electrical interlock ⓐ Closed circuit principle for interlocking the switch movement. When the coil circuit is dead, A-types cannot be operated to ON-position and L-types cannot be operated to ON- or OFF-position. Coil voltages 110VAC, 220VAC, 24VDC, 48VDC, 60 VDC, 110VDC, 220VDC, P = 15W U = 0.7 – 1.1 Un (U = coil voltage, Un = nominal voltage)	BDNF175A – BDNF200A	2.42	CDETL-ZT80A/★ CDETL-ZT80L/★
Mounting bracket	BDNF175A – BDNF200A	0.35	CDETL-ZT140

★ - Coil voltage

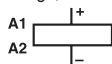

Shaft extension coupler

Description	For use on:	Weight (lbs.)	Catalog number
Joins two shafts together for applications where extended length is required	12mm shafts	0.26	BDZW95

Shaft adapter

Description	For use on:	Weight (lbs.)	Catalog number
Adapts one end of an 8mm shaft to a 12mm shaft. Use with shaft extension coupler.	8mm shafts	0.20	CDZT123

ⓐ CDETL-ZT140 mounting bracket required.

for 175A – 200A Non-Fusible Disconnect Switches

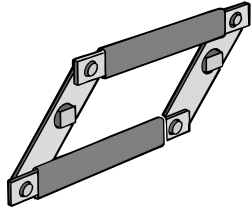

BDZW18

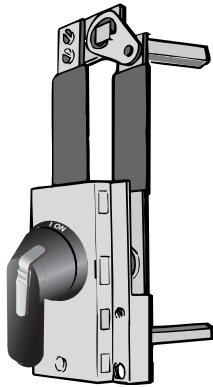

BDZW20

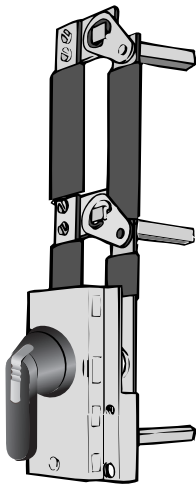

BDZW21

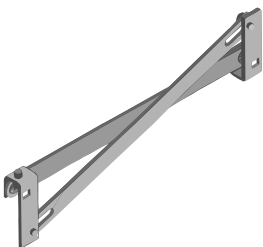

BDZW19

Conversion mechanisms

- Switches are not included

Description	For use on:	Weight (lbs)	Catalog number
6 or 8 pole Transfer Bypass	BDNF175A BDNF200A	1.61	BDZW18
		6.17	BDZW20
		6.17	BDZW20X
		7.27	BDZW21
		7.27	BDZW21X
Mechanical interlock		4.41	BDZW19

6 or 8 pole — BDZW18

6 (8) pole mechanism allows two switches controlled by one handle to open or close simultaneously. Shafts included.

Equipment required for a complete installation:

- One conversion mechanism
- Two disconnect switches
- One handle

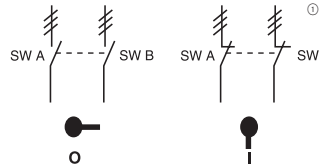

	POS. O	POS. I
SW. A	O	X
SW. B	O	X

X = Closed
O = Open

Transfer — BDZW20

Transfer mechanism manually transfers between two power sources using two switches and a center OFF position.

A 3-position handle is included:

(Type 1, 3R, 12) or

(Type 1, 3R, 4, 4X, 12)

Shafts included. Equipment required for a complete installation:

- One conversion mechanism
- Two disconnect switches

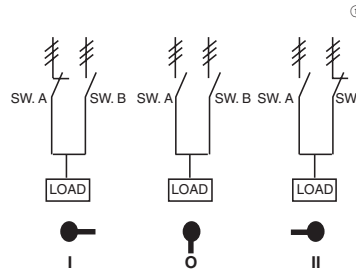

	POS. I	POS. O	POS. II
SW. A	X	O	O
SW. B	O	O	X

X = Closed
O = Open

Bypass — BDZW21

Bypass mechanism operates three switches: Two switches in series and one changeover switch to allow power bypass.

A 3-position handle is included:

(Type 1, 3R & 12) or

(Type 1, 3R, 4, 4X, 12)

Shafts included.

Equipment required for a complete installation:

- One conversion mechanism
- Three disconnect switches

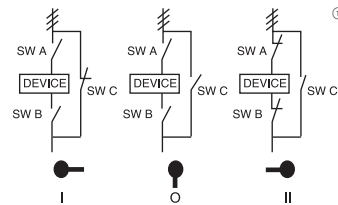

	POS. I	POS. O	POS. II
SW. A	O	O	X
SW. B	O	O	X
SW. C	X	O	O

X = Closed
O = Open

Mechanical interlock — BDZW19

Mechanical interlock mechanism prevents both switches from being in the ON position at the same time.

Equipment required for a complete installation:

- One conversion mechanism
- Two disconnect switches
- Two handles
- Two shafts



	SW. A POS. I	SW. B POS. I
SW. A	X	O
SW. B	O	X

X = Closed
O = Open

① ≡ = Three poles

Non-Fusible Disconnect Switches

For a complete assembly, please select one of each:

- 1 switch
- 1 handle
- 1 shaft
- 1 terminal lug kit

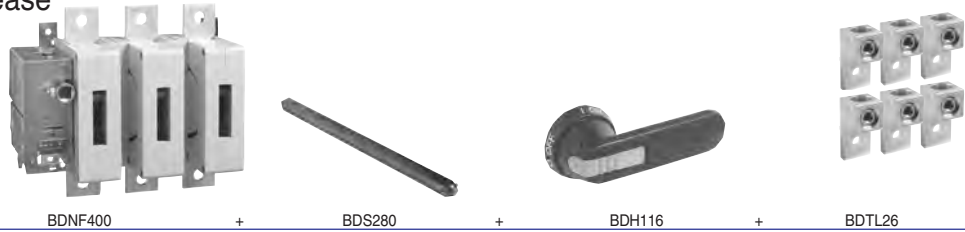

Fusible

Non-Fused

Enclosed Fused

Enclosed Non-Fused



BDNF600A



BDNF800A



BDH112-117



BDS280

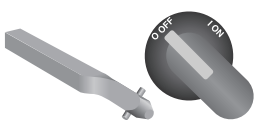

BDS_45

400 – 800 Amp switches, 600V

UL general purpose amp rating	IEC AC21 amp rating	Maximum horsepower rating					Catalog number
		200V	208V	240V	480V	600V	
2 pole							
400	630	—	—	—	—	—	BDNF4002 BDNF600A2 BDNF800A2
600	800	—	—	—	—	—	
800	1250	—	—	—	—	—	
3 pole							
400	630	100	100	125	250	350	BDNF400 BDNF600A BDNF800A
600	800	150	150	200	400	500	
800	1250	200	200	250	500	600	
4 pole							
400	630	100	100	125	250	350	BDNF4004 BDNF600A4 BDNF800A4
600	800	150	150	200	400	500	
—	1250	200	200	250	500	600	

Pistol handles — for use with shafts □ .47 x .47" (□ 12 x 12 mm)

NEMA type	IEC type	Color	Length in/mm	Marking	Defeatable	Padlockable	Weight (lbs)	Catalog number
1,3R,12	IP65	Blk	4.9/125	O/I & Off/On	Yes	Yes	0.39	BDH112
1,3R,12	IP65	R/Y	4.9/125	O/I & Off/On	Yes	Yes	0.39	BDH113
1,3R,12	IP65	Blk	5.7/145	O/I & Off/On	Yes	Yes	0.39	BDH114
1,3R,12	IP65	R/Y	5.7/145	O/I & Off/On	Yes	Yes	0.39	BDH115
1,3R,12	IP65	Blk	6.9/175	O/I & Off/On	Yes	Yes	0.41	BDH116
1,3R,12	IP65	R/Y	6.9/175	O/I & Off/On	Yes	Yes	0.41	BDH117
1,3R,4,4X,12	IP66	Blk	5.7/145	O/I & Off/On	Yes	Yes	0.39	CDHXB12
1,3R,4,4X,12	IP66	R/Y	5.7/145	O/I & Off/On	Yes	Yes	0.39	CDHXY12
1,3R,4,4X,12	IP66	Blk	6.9/175	O/I & Off/On	Yes	Yes	0.41	CDHXB22
1,3R,4,4X,12	IP66	R/Y	6.9/175	O/I & Off/On	Yes	Yes	0.41	CDHXY22
1,3R,4,4X,12	IP65	Metal	8.7/220	Off/On	—	Yes	1.50	BDH8

Shafts — for use with pistol handles □ .47 x .47" (□ 12 x 12 mm)

Shaft length inches/mm	Mounting depth ^① in inches	Weight (lbs)	Catalog number
11.0/280	10.2 – 14.5	0.77	BDS280
12.8/325	12.0 – 16.3	0.90	BDS325
15.6/395	14.8 – 19.1	1.10	BDS395
18.3/465	17.5 – 21.9	1.32	BDS465
21.1/535	20.3 – 24.6	1.54	BDS535

Twisted shafts — Rotates handle 45° □ .47 x .47" (□ 12 x 12 mm)

Shaft length inches/mm	Mounting depth ^① in inches	Weight (lbs)	Catalog number
11.0/280	10.2 – 14.5	0.77	BDS28045
12.8/325	12.0 – 16.3	0.90	BDS32545
18.3/465	17.5 – 21.9	1.32	BDS46545

① Mounting depth is the distance from the outside of the door to the disconnect switch mounting plate. Shaft can be cut to desired length.

for 400A – 800A Non-Fusible Disconnect Switches

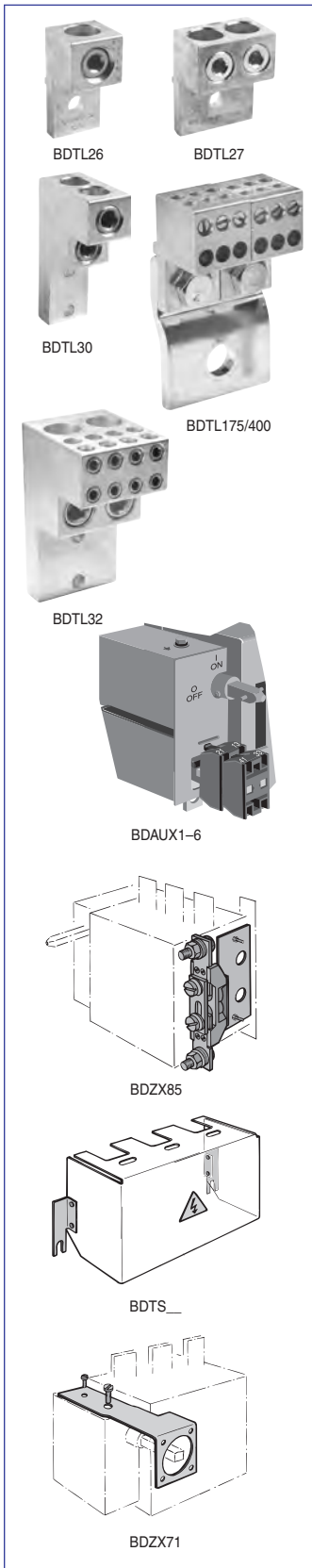

Terminal lug kits

For use on:	Wire size	Kit weight (lbs.)	Wire type	Terminal lugs per kit	Kit catalog number
BDNF400	#2 – 600 kcmil	3.50	Cu/Al	6	BDTL26
BDNF400	(2) #2 – 500 kcmil	4.62	Cu/Al	6	BDTL262
BDNF600A	(2) #2 – 600 kcmil	4.62	Cu/Al	6	BDTL27
BDNF800A	(2) #2 – 600 kcmil	6.90	Cu/Al	6	BDTL30
BDNF800A ^①	(8) 2/0 + (2)#2 600 kcmil	6.90	Cu/Al	3	BDTL32
BDNF400 – BDNF600A ^①	(12) #14 – 6	1.10	Cu/Al	6	BDTL175/400

Auxiliary contacts^②

Description	For use on:	Weight (lbs)	AC thermal amp rating	AC rated voltage	Catalog number
1 N.O. + 1 N.C.	BDNF400 – BDNF800A	0.20	10	600	BDAUX1
2 N.O. + 2 N.C.		0.26	10	600	BDAUX2
4 N.O. + 4 N.C.		0.40	10	600	BDAUX3
2 N.O.		0.18	10	600	BDAUX4
4 N.O.		0.25	10	600	BDAUX5
8 N.O.		0.40	10	600	BDAUX6

Terminal poles

Description	For use on:	Weight (lbs)	AC thermal amp rating	AC rated voltage	Catalog number
Detachable neutral mounts on side of switch or DIN rail	BDNF400 – BDNF600A	1.04	400	600	BDZX85

Terminal shrouds

Description	For use on:	Weight (lbs)	Catalog number
Includes one shroud for line or load side	BDNF400	0.62	BDTS4
	BDNF600A	0.66	BDTS6A
	BDNF800A	0.88	BDTS8A

Handle support bracket

Description	For use on:	Weight (lbs)	Catalog number
Allows handle to be directly mounted to switch behind the door	BDNF400 – BDNF600A	0.51	BDZX73
	BDNF800A	0.88	BDZX71

^① A load side distribution lug eliminates the need to purchase, install and wire a separate distribution block.

^② UL File E57057

Fusible

Non-Fused

Enclosed Fused

Enclosed Non-Fused

for 400A – 800A Non-Fusible Disconnect Switches

Fusible

Non-Fused

Enclosed Fused

Enclosed Non-Fused

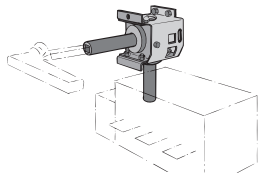

BDZX108

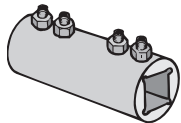

BDZW95

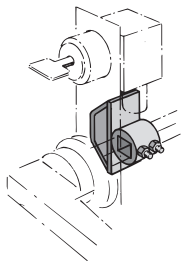

CDETL-ZW5

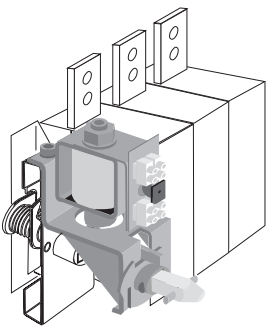

CDETL-ZT80

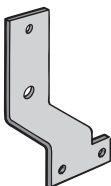

CDETL-ZT100

90° angle kit

Description	For use on:	Weight (lbs)	Catalog number
Converts switch mechanism from front operation to side operation	BDNF400 BDNF600A BDNF800A	4.63	BDZX108

Shaft extension coupler

Description	For use on:	Weight (lbs)	Catalog number
Joins two shafts together for applications where extended length is required	12mm shafts	0.26	BDZW95

Locking accessories

Description	For use on:	Weight (lbs)	Catalog number
Cam attachment for Kirk Key, Castell, Lowe & Fletcher and Ronis interlock. For adapting to the interlock system The interlock is not included.	12mm shafts	0.29	CDETL-ZW5
Electrical interlock ① Closed circuit principle for interlocking the switch movement. When the coil circuit is dead, A-types cannot be operated to ON-position and L-types cannot be operated to ON- or OFF-position. Coil voltages 110VAC, 220VAC, 24VDC, 48VDC, 60 VDC, 110VDC, 220VDC, P = 15W U = 0.7 – 1.1 Un (U = coil voltage, Un = nominal voltage)	BDNF400 BDNF600A BDNF800A	2.42	CDETL-ZT80A/★ CDETL-ZT80L/★
Mounting bracket	BDNF400 BDNF600A	0.40	CDETL-ZT100

★ – Coil voltage

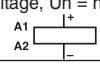

① CDETL-ZT100 mounting bracket required for BDNF400 & BDNF600A

for 400A – 800A Non-Fusible Disconnect Switches

Fusible

Non-Fused

Enclosed Fused

Enclosed Non-Fused

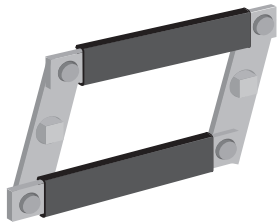

BDZW9

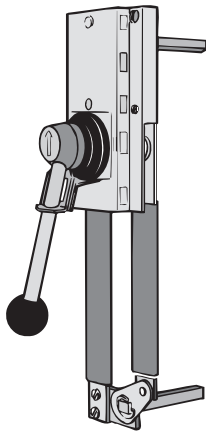

BDZW12

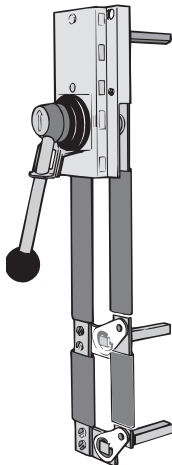

BDZW13

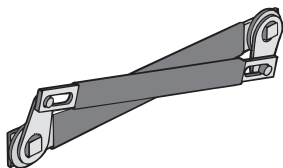

BDZW3, 14, 15

Conversion mechanisms

- Switches are not included

Description	For use on:	Weight (lbs)	Catalog number
6 or 8 pole Transfer Bypass	BDNF400 BDNF600A BDNF800A	2.42	BDZW9
		10.1	BDZW12
		8.81	BDZW13
Mechanical interlock	BDNF400 BDNF600A BDNF800A	1.26	BDZW3
		1.15	BDZW14
		2.64	BDZW15

6 or 8 pole — BDZW9

6 (8) pole mechanism allows two switches controlled by one handle to open or close simultaneously. One shaft included.

Equipment required for a complete installation:

- One conversion mechanism
- Two disconnect switches
- One handle
- One additional shaft (Only one shaft is included with mechanism).

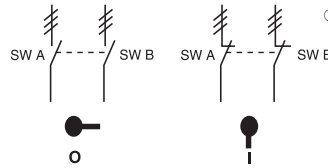

	POS.O	POS.I
SW. A	O	X
SW. B	O	X

X = Closed
O = Open

Transfer — BDZW12

Transfer mechanism manually transfers between two power sources using two switches and a center OFF position. A 3 position handle is included.

Shafts included.

Equipment required for a complete installation:

- One conversion mechanism
- Two disconnect switches

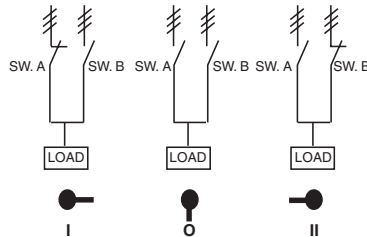

	POS. I	POS.O	POS.II
SW. A	X	O	O
SW. B	O	O	X

X = Closed
O = Open

Bypass — BDZW13

Bypass mechanism operates three switches: Two switches in series and one changeover switch to allow power bypass. A 3 position handle is included. (UL Type 1, 3R, 4, 4X, 12). Shafts included.

Equipment required for a complete installation:

- One conversion mechanism
- Three disconnect switches

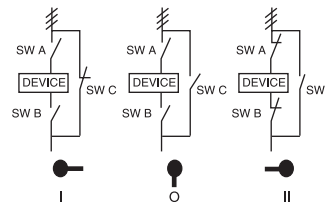

	POS. I	POS.O	POS.II
SW. A	O	O	X
SW. B	O	O	X
SW. C	X	O	O

X = Closed
O = Open

Mechanical interlock — BDZW3, BDZW14, BDZW15

Mechanical interlock mechanism prevents both switches from being in the ON position at the same time.

Equipment required for a complete installation:

- One conversion mechanism
- Two disconnect switches
- Two shafts
- Two handles

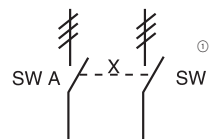

	SW. A POS. I	SW. B POS. I
SW. A	X	O
SW. B	O	X

X = Closed
O = Open

① ≡ = Three poles

Non-Fusible Disconnect Switches

For a complete assembly please select one of each:

- 1 switch
- 1 handle
- 1 shaft
- 1 terminal lug kit



BDNF1200



BDS280



BDH117



BDTL28

Fusible

Non-Fused

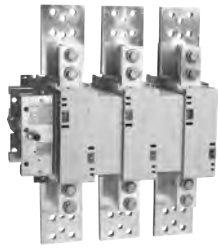

BDNF1600
BDNF2000
BDNF3150



BDH114



BDH115



BDH8



BDS325

Enclosed Fused

Enclosed Non-Fused

1200 – 3150 Amp switches, 600V

UL general purpose amp rating	IEC AC21 amp rating	Maximum horsepower rating	Catalog number
			<p>2 pole</p> <p>1200 1600 2000 —</p> <p>3 pole</p> <p>1200 1600 2000 —</p> <p>4 pole</p> <p>— — — —</p>

Pistol handles — for use with shaft □ .47 x .47" (□ 12 x 12mm)

NEMA type	IEC type	Color	Length mm	Marking	Defeatable	Padlockable	Weight (lbs)	Catalog number
For use with BDNF1200								
1,3R,12	IP65	Black	5.7/145	O/I & Off/On	Yes	Yes	0.39	BDH114
1,3R,12	IP65	Red/Yellow	5.7/145	O/I & Off/On	Yes	Yes	0.39	BDH115
1,3R,12	IP65	Black	6.9/175	O/I & Off/On	Yes	Yes	0.41	BDH116
1,3R,12	IP65	Red/Yellow	6.9/175	O/I & Off/On	Yes	Yes	0.41	BDH117
1,3R,4,4X,12	IP66	Black	5.7/145	O/I & Off/On	Yes	Yes	0.39	CDHXB12
1,3R,4,4X,12	IP66	Red/Yellow	5.7/145	O/I & Off/On	Yes	Yes	0.39	CDHXY12
1,3R,4,4X,12	IP66	Black	6.9/175	O/I & Off/On	Yes	Yes	0.41	CDHXB22
1,3R,4,4X,12	IP65	Red/Yellow	6.9/175	O/I & Off/On	Yes	Yes	0.41	CDHXY22
For use with BDNF1600 – 3150								
1,3R,4,4X,12	IP65	Metal	8.7/220	Off/On	—	Yes	1.50	BDH8

Shafts — for use with pistol handles □ .47 x .47" (□ 12 x 12 mm)

Shaft length inches/mm	Mounting depth [Ⓢ] in inches	Weight (lbs)	Catalog number
For use with BDNF1200			
11.0/280	11.6 – 15.3	0.77	BDS280
12.8/325	13.7 – 17.1	0.90	BDS325
15.6/397	16.2 – 19.9	1.10	BDS395
18.3/465	18.9 – 22.6	1.32	BDS465
21.1/536	21.7 – 25.4	1.54	BDS535
For use with BDNF1600 – 3150			
12.8/325	13.7 – 17.1	0.90	BDS325
15.6/397	16.2 – 19.9	1.10	BDS395
18.3/465	18.9 – 22.6	1.32	BDS465
21.1/536	21.7 – 25.4	1.54	BDS535

Ⓢ Mounting depth is the distance from the outside of the door to the disconnect switch mounting plate. Shaft can be cut to desired length.

for 1200A – 3150A Non-Fusible Disconnect Switches

Fusible

Non-Fused

Enclosed Fused

Enclosed Non-Fused

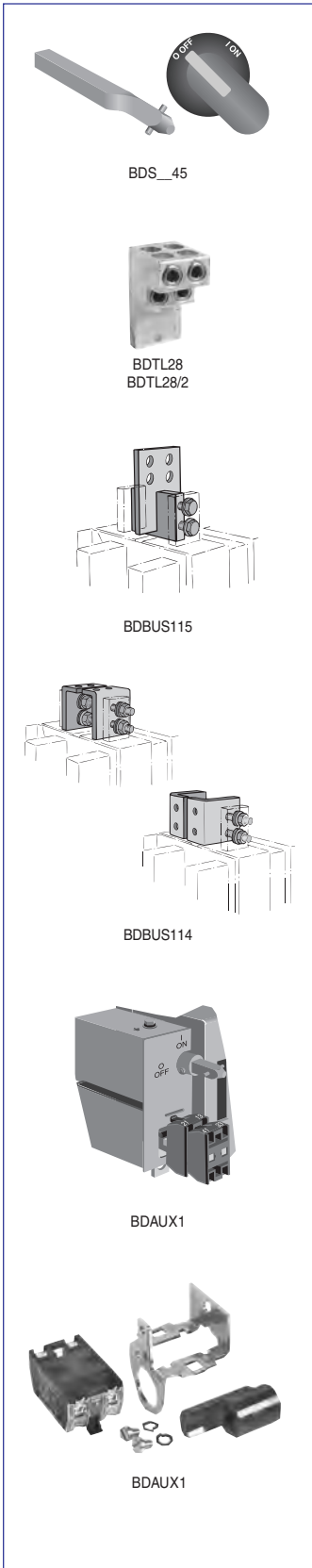

Twisted shafts – Rotates handle 45° □ .47 x .47" (□ 12 x 12 mm)

Shaft length inches/mm	Mounting depth ^① inches	Weight (lbs)	Catalog number
For use with BDNF1200			
11.0/280	11.6 – 15.3	0.77	BDS28045
12.8/325	13.7 – 17.1	0.90	BDS32545
18.3/465	18.9 – 22.6	1.32	BDS46545
For use with BDNF1600 – 3150			
12.8/325	16.2 – 19.9	0.90	BDS32545
18.3/465	18.9 – 22.6	1.32	BDS46545

Terminal lug kits

For use on:	Wire size	Kit weight (lbs.)	Wire type	Terminal lugs per kit	Kit catalog number
BDNF1200 & BDNF1600	(4) #2 – 600kcmil	10.44	Cu/Al	6	BDTL28
BDNF1200 & BDNF1600 ^②	(8) 2/0 + (2) #2 600kcmil	10.44	Cu/Al	3	BDTL32
BDNF2000 & BDNF3150	(8) #2 – 600kcmil	20.88	Cu/Al	12	BDTL28/2

BDTL32 Power distribution lugs eliminate the need to purchase a separate distribution block

Busbar connections

Description	For use on:	Weight (lbs)	Catalog number
Vertical mounting ^③	BDNF1600 – BDNF3150	46.2	BDBUS115
Vertical, back or edgewise mounting		31.0	BDBUS114

Auxiliary contacts^④

Description	For use on:	Weight (lbs)	AC thermal amp rating	AC rated voltage	Catalog number
1 N.O. + 1 N.C.	BDNF1200 – BDNF3150	0.20	10	600	BDAUX1
2 N.O. + 2 N.C.		0.26	10	600	BDAUX2
4 N.O. + 4 N.C.		0.40	10	600	BDAUX3
2 N.O.		0.18	10	600	BDAUX4
4 N.O.		0.25	10	600	BDAUX5
8 N.O.		0.40	10	600	BDAUX6

Terminal shrouds

Description	For use on:	Weight (lbs)	Catalog number
Includes one shroud for line or load side	BDNF1200	1.20	BDTS12

① Mounting depth is the distance from the outside of the door to the disconnect switch mounting plate. Shaft can be cut to desired length.

② A load side distribution lug eliminates the need to purchase, install and wire a separate distribution block.

③ Provided as standard with BDNF1600, BDNF2000 and BDNF3150.

for 1200A – 3150A Non-Fusible Disconnect Switches

Fusible

Non-Fused

Enclosed Fused

Enclosed Non-Fused

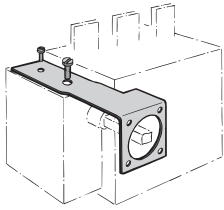

BDZX71

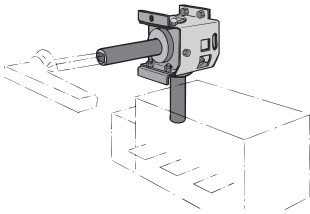

BDZX90

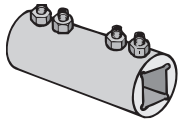

BDZW95

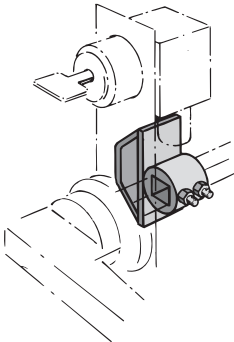

CDETL-ZW5

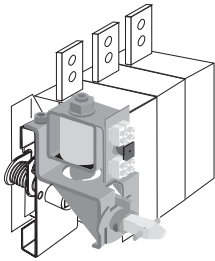

CDETL-ZT80

Handle support bracket

Description	For use on:	Weight (lbs)	Catalog number
Allows handle to be directly mounted to switch behind the door	BDNF1200 – BDNF3150	0.88	BDZX71

90° angle kit

Description	For use on:	Weight (lbs)	Catalog number
Converts switch mechanism from front operation to side operation	BDNF1200 – BDNF3150	4.63	BDZX90

Shaft extension coupler

Description	For use on:	Weight (lbs)	Catalog number
Joins two shafts together for applications where extended length is required	12mm shafts	0.26	BDZW95

Locking accessories

Description	For use on:	Weight (lbs)	Catalog number
Cam attachment for Kirk Key, Castell, Lowe & Fletcher and Ronis interlock. For adapting to the interlock system. The interlock is not included.	12mm shafts	0.29	CDETL-ZW5
Electrical interlock Closed circuit principle for interlocking the switch movement. When the coil circuit is dead, A-types cannot be operated to ON-position and L-types cannot be operated to ON- or OFF-position. Coil voltages 110VAC, 220VAC, 24VDC, 48VDC, 60 VDC, 110VDC, 220VDC; P = 15W U = 0.7 – 1.1 Un (U= coil voltage, Un = nominal voltage)	BDNF1200 – BDNF3150	2.42	CDETL-ZT80A/★ CDETL-ZT80L/★



★ = Coil voltage

for 1200A – 3150A Non-Fusible Disconnect Switches

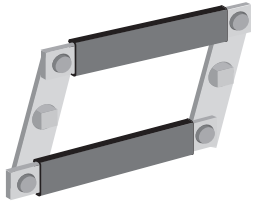

BDZW9

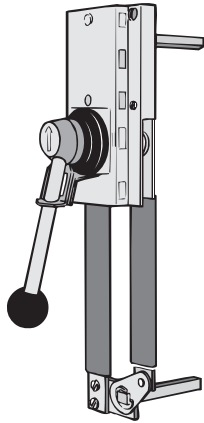

BDZW12

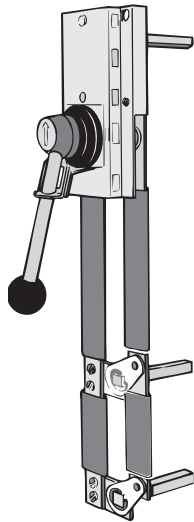

BDZW13

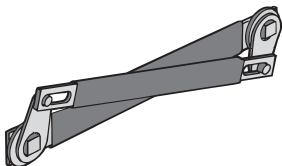

BDZW15

Conversion mechanisms

- Switches are not included

Description	For use on:	Weight (lbs)	Catalog number
6 or 8 pole Transfer Bypass	BDNF1200	2.42	BDZW9 BDZW12 BDZW13
		10.1	
		8.81	
Mechanical interlock	BDNF1200 – BDNF3150	2.64	BDZW15

6 or 8 pole — BDZW9

6 (8) pole mechanism allows two switches controlled by one handle to open or close simultaneously. One shaft included. Equipment required for a complete installation:

- One conversion mechanism.
- Two disconnect switches
- One handle
- One additional shaft (Only one shaft is included with mechanism)

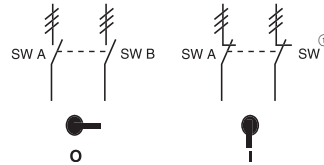

	POS. O	POS. I
SW. A	O	X
SW. B	O	X

X = Closed
O = Open

Transfer — BDZW12

Transfer mechanism manually transfers between two power sources using two switches and a center OFF position. A 3 position handle is included. Shafts included.

Equipment required for a complete installation:

- One conversion mechanism
- Two disconnect switches

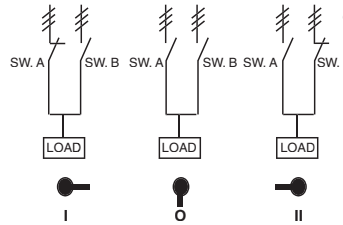

	POS. I	POS. O	POS. II
SW. A	X	O	O
SW. B	O	O	X

X = Closed
O = Open

Bypass — BDZW13

Bypass mechanism operates three switches: Two switches in series and one changeover switch to allow power bypass. A 3 position handle is included. Shafts included.

Equipment required for a complete installation:

- One conversion mechanism
- Three disconnect switches

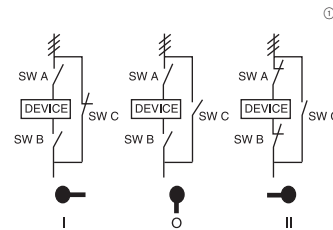

	POS. I	POS. O	POS. II
SW. A	O	O	X
SW. B	O	O	X
SW. C	X	O	O

X = Closed
O = Open

Mechanical interlock —BDZW15

Mechanical interlock mechanism prevents both switches from being in the "ON" position at the same time. Handles are not included.

Equipment required for a complete installation:

- One conversion mechanism
- Two disconnect switches
- Two shafts
- Two handles

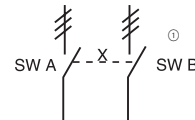

	SW. A POS. I	SW. B POS. I
SW. A	X	O
SW. B	O	X

X = Closed
O = Open

① ≡ Three poles

30A – 800A^{①②}

For a complete assembly, please select one of each:

- 1 switch
- 1 handle
- 1 shaft
- 1 terminal lug kit

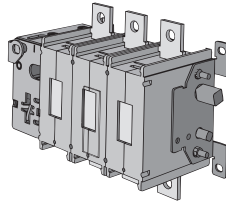

BDFLNF200A-S



BDS240



BDH110SH

Fusible

Non-Fused

Enclosed Fused

Enclosed Non-Fused



BDFLNF30-S



BDH107SH

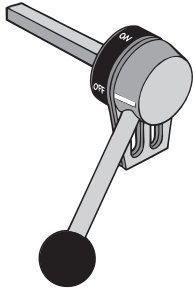

BDZX74



CDS67P
BDS240
BDS325



BDTL24



BDTL25



BDTL26



BDTL27

Side operated switches – 3 pole

UL general purpose amp rating	IEC AC21 amp rating	Maximum horsepower rating					Weight (lbs)	Catalog number
		Three phase						
		200V	208V	240V	480V	600V		
30	32	5	7.5	7.5	15	20	1.90	BDFLNF30-S
60	63	15	15	15	30	50	3.90	BDFLNF60-S
100	125	25	25	30	60	75	4.50	BDFLNF100-S
175	200	30	30	40	75	100	6.61	BDFLNF175-S
200	250	60	60	75	150	200	6.61	BDFLNF200A-S
400	630	100	100	125	250	350	13.66	BDFLNF400-S
600	800	150	150	200	400	500	13.66	BDFLNF600A-S

Handles

UL type	Color	Length inches/mm	Marking	Defeatable	Padlockable	Weight (lbs)	Catalog number
For use with BDFLNF30-S							
1, 12, 3R	Black	2.65/65	O/1 & Off/On	Yes	Yes	0.29	BDH106SH
1, 12, 3R	Red/Yellow	2.65/65	O/1 & Off/On	Yes	Yes	0.29	BDH107SH
For use with BDFLNF60-S — BDFLNF200A-S							
1, 12, 3R	Black	3.1/80	O/1 & Off/On	Yes	Yes	0.30	BDH110SH
1, 12, 3R	Red/Yellow	3.1/80	O/1 & Off/On	Yes	Yes	0.30	BDH111SH
For use with BDFLNF400-S — BDFLNF600A-S							
1, 12, 3R	Black	4.9/145	O/1 & Off/On	Yes	Yes	0.39	BDH114SH
1, 12, 3R	Red/Yellow	4.9/145	O/1 & Off/On	Yes	Yes	0.39	BDH115SH
1, 12, 3R	metal	4.9/145	Off/On	Yes	Yes	1.50	BDZX74

Shafts

For use with:	Length inches/mm	Description	Weight (lbs)	Catalog number
BDFLNF30-S	6.7/170	.20 x .20" (5 x 5mm)	0.08	CDS67P
BDFLNF60 – 100	8.3/210	.24 x .24" (6 x 6mm)	0.10	BDS210
BDFLNF175 – 200	9.5/240	.31 x .31" (8 x 8mm)	0.26	BDS240
BDFLNF400-S – 600A-S	12.8/325	.47 X .47" (12 X 12mm)	0.90	BDS325

Terminal lug kits

For use on:	Wire size	Weight (lbs)	Wire type	Lugs per kit	Catalog number
BDFLNF30-S	#14 – 4	—	Cu	—	Integral
BDFLNF60-S	#14 – 4	—	Cu	—	Integral
BDFLNF100-S	#14 – 2/0	0.43	Cu/Al	6	BDTL24
BDFLNF175-S	#6 – 300 kcmil	0.93	Cu/Al	6	BDTL25
BDFLNF200A-S	#6 – 300 kcmil	0.93	Cu/Al	6	BDTL25
BDFLNF400-S	#2 – 600 kcmil	3.520	Cu/Al	6	BDTL26
BDFLNF600A-S	(2) #2 – 600 kcmil	4.62	Cu/Al	6	BDTL27

① Side operated switches available through 800A as IEC rated.

30A – 200A

For a complete assembly, please select one of each:

- 1 switch
- 1 handle
- 1 shaft
- 1 terminal lug kit

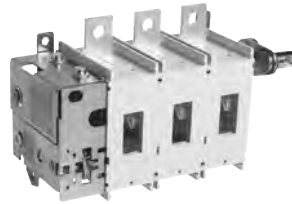

BDFLN200A-F



BDFHS12



BDFHNHS12



BDTL25

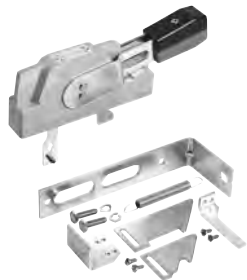

BDFHNHS12



BDFHS12



BDTL24



BDTL25

UL Listed
CSA Approved
IEC Rated
CE Marked

Flange operated switches – 3 pole

UL general purpose amp rating	IEC AC21 amp rating	Maximum horsepower rating					Weight (lbs)	Catalog number
		Three phase						
		200V	208V	240V	480V	600V		
30	40	10	10	10	20	30	2.80	BDFLN30-F
60	63	20	20	20	40	40	3.90	BDFLN60-F
100	115	25	25	25	50	40	4.50	BDFLN100-F
200	250	60	60	75	150	200	6.61	BDFLN200A-F

Flange handles

NEMA/UL type	Color	Length inches/mm	Marking	Defeatable	Padlockable	Weight (lbs)	Catalog number
1, 3R, 12	Metal	6.9/175	O/I & OFF/ON	Yes	Yes	3.52	BDFHNHS12
4, 4X	Metal	6.9/175	O/I & OFF/ON	Yes	Yes	3.52	BDFHNHS4

Shafts

Shaft length inches	Weight (lbs)	Catalog number
12	0.39	BDFHS12
17	0.55	BDFHS17
22.5	0.73	BDFHS22

Terminal lug kits

For use on:	Wire size	Kit weight (lbs)	Wire type	Terminal lugs per kit	Catalog number
BDFLN30-F	#14 – #4	—	Cu	—	Standard
BDFLN60-F	#14 – #4	—	Cu	—	BDTL24
BDFLN100-F	#14 – 2/0	—	Cu	—	BDTL25
BDFLN200A-F	#6 – 300 kcmil	0.93	Cu/Al	6	BDTL25

Door hardware – NEMA 12

Description	Weight (lbs)	Catalog number
Safety door latch, 2 point with 6" handle.	1.92	BBDHK
Roller for 3 point latch, add to BBDHK	.39	BD3RL

Fusible

Non-Fused

Enclosed Fused

Enclosed Non-Fused

for Non-Fusible Disconnect Switches
CDNF16 – CDFN160

UL & CSA

Catalog number	3 pole	CDNF16	CDNF25	CDNF32	CDNF45	CDNF63	CDNF30	CDNF60	CDNF100	CDNF160
Approvals ^①	2 pole 3 pole 4 pole	N/A UL508 & IEC UL508 & IEC	N/A UL508 & IEC UL508 & IEC	N/A UL508 & IEC UL508 & IEC	N/A UL508 & IEC UL508 & IEC	N/A UL508 & IEC UL508 & IEC	N/A UL98 & IEC UL98 & IEC	N/A UL98 & IEC UL98 & IEC	N/A UL98 & IEC UL98 & IEC	UL98 & IEC UL98 & IEC UL98 & IEC
General purpose amp rating pf = 0.7 – 0.8	-40° to 40°C A	16	25	40	60	80	30	60	100	125
Max. operating voltage	V	600	600	600	600	600	600	600	600	600
Max. horsepower rating/motor FLA current, pf = 0.4 – 0.5										
Three phase	200V – 208V HP/A	3/10.6	7.5/24.2	10/30.8	15/46.2	20/60.0	10/30.8	20/60.0	25/75.0	30/88.0
	240V HP/A	5/15.2	7.5/22.0	10/28.0	15/42.0	20/54.0	10/28.0	20/54.0	25/68.0	30/80.0
	480V HP/A	10/14.0	15/21.0	20/27.0	30/40.0	40/52.0	20/27.0	40/52.0	50/65.0	60/77.0
	600V HP/A	10/11.0	20/22.0	25/27.0	20/22.0	40/41.0	30/32.0	40/41.0	40/41.0	75/77.0
Single phase	120V HP/A	0.5/9.8	0.75/13.8	1/16.0	2/24.0	2/24.0	2/24.0	3/34.0	5/56.0	7.5/80
	240V HP/A	1.5/10.0	2/12.0	3/17.0	5/28.0	5/28.0	5/28.0	7.5/40.0	15/68.0	20/88.0
Short circuit rating with fuse										
Fuse type CC	kA	10	10	10	100	100	50	50	50	100
Fuse type J	kA	10	10	10	100	100	50	50	50	100
Fuse type T	kA	10	10	10	100	100	50	50	50	100
Fuse type RK1	kA	10	10	10	100	100	50	50	50	100
Fuse type RK5	kA	5	5	5	5	10	5	5	5	5
Fuse type L	kA	—	—	—	—	—	—	—	—	—
Fuse type H	kA	—	—	—	—	5	5	5	5	5
Fuse size	A	30 60	30 60	30 60	100 150	100 150	60	60 100	60 100	200
Short circuit rating with MCCB	kA	—	—	—	—	—	—	—	—	25
Endurances										
Min. Electrical endurance, pf = 0.75 – 0.80	operation cycles	6000	6000	6000	6000	6000	6000	6000	6000	6000
Min. Electrical endurance, pf = 0.40 – 0.50	operation cycles	1000	1000	1000	1000	1000	②	②	②	②
Mechanical endurance	operations	20,000	20,000	20,000	20,000	20,000	20,000	20,000	20,000	16,000
Physical characteristics										
Weight, switches	3 pole lb	0.24	0.24	0.24	0.59	0.59	0.79	0.79	0.79	2.42
	4 pole lb	0.33	0.33	0.33	0.77	0.77	1.10	1.10	1.10	2.86
Dimension, switches	3 pole H in	2.68	2.68	2.68	3.60	3.60	3.94	3.94	3.94	5.00
	W in	1.38	1.38	1.38	2.07	2.07	2.76	2.76	2.76	4.96
	D in	2.20	2.20	2.20	2.85	2.85	2.95	2.95	2.95	2.93
Shaft size — square □	in	.20 x .20	.20 x .20	.20 x .20	.20 x .20	.20 x .20	.20 x .20	.20 x .20	.20 x .20	.24 x .24
	mm	5 x 5	5 x 5	5 x 5	5 x 5	5 x 5	5 x 5	5 x 5	5 x 5	6 x 6
Switch operating torque for rotary 3 pole switches	lb. in.	8.8	8.8	8.8	10.5	10.5	17.5	17.5	17.5	52.5
Terminal lug kits										
Wire range	AWG	#18 – 8	#18 – 8	#18 – 8	#14 – 4	#14 – 1	#14 – 4	#14 – 4	#8 – 1/0	#8 – 1/0
Torque:										
Wire tightening	lb. in.	7	7	7	18	18	55	55	55	70
Lug mounting	lb. in.	Integral	Integral	Integral	Integral	Integral	Integral	Integral	Integral	Integral
Auxiliary contacts										
NEMA ratings, AC		A600	A600	A600	A600	A600	A600	A600	A600	A600
AC rated voltage	VAC	600	600	600	600	600	600	600	600	600
AC thermal rated current	A	10	10	10	10	10	10	10	10	10
AC maximum volt-ampere making	VA	7200	7200	7200	7200	7200	7200	7200	7200	7200
AC maximum volt-ampere breaking	VA	720	720	720	720	720	720	720	720	720
NEMA ratings, DC		R300	R300	R300	R300	R300	R300	R300	R300	P600
DC rated voltage	VDC	300	300	300	300	300	300	300	300	600
DC thermal rated current	A	1	1	1	1	1	1	1	1	5
DC maximum make-break	VA	28	28	28	28	28	28	28	28	138
Torque:										
Wire tightening	lb. in.	7	7	7	7	7	7	7	7	7
Wire range	AWG	#18 – 14	#18 – 14	#18 – 14	#18 – 14	#18 – 14	#18 – 14	#18 – 14	#18 – 14	#22 – 14

① UL Listed switches are also CSA Approved.

② UL98 overload test, 50 operations, pf 0.40 – 0.50 at 2x FLA.

for Non-Fusible Disconnect Switches
BDNF175 – BDNF3150

UL & CSA

Catalog number	3 pole	BDNF175	BDNF200A	BDNF400	BDNF600A	BDNF800A	BDNF1200	BDNF1600	BDNF2000	BDNF3150 ①
Approvals ^①	2 pole 3 pole 4 pole	UL508 & IEC UL508 & IEC IEC	UL98 & IEC UL98 & IEC IEC	UL98 & IEC UL98 & IEC UL98 & IEC	UL98 & IEC UL98 & IEC UL98 & IEC	UL98 & IEC UL98 & IEC IEC	UL98 & IEC UL98 & IEC IEC	UL98 & IEC UL98 & IEC IEC	UL98 & IEC UL98 & IEC IEC	IEC IEC IEC
General purpose amp rating	-40° to 40°C	175	200	400	600	800	1200	1600	2000	3150
pf = 0.7 – 0.8	A									
Max. operating voltage	V	600	600	600	600	600	600	600	480	—
Max. horsepower rating/Max. motor FLA current, pf = 0.4 – 0.5										
Three phase	200 – 208V HP/A	30/88.0	60/160.0	100/273.0	150/396.0	200/528.0	—	—	—	—
	240V HP/A	40/104.0	75/192.0	125/312.0	200/480.0	250/602.0	—	—	—	—
	480V HP/A	75/96.0	150/180.0	250/302.0	400/477.0	500/590.0	—	—	—	—
	600V HP/A	100/99.0	200/192.0	350/336.0	500/472.0	600/576	—	—	—	—
Single phase	120V HP/A	—	—	—	—	—	—	—	—	—
	240V HP/A	—	—	—	—	—	—	—	—	—
Short circuit rating with fuse										
Fuse type CC	kA	—	—	—	—	—	—	—	—	—
Fuse type J	kA	100	—	—	—	—	—	—	—	—
Fuse type T	kA	—	—	—	—	—	—	—	—	—
Fuse type RK1	kA	—	—	—	—	—	—	—	—	—
Fuse type RK5	kA	—	—	—	—	—	—	—	—	—
Fuse type L	kA	—	—	—	—	—	100	100	100	—
Fuse type H	kA	—	—	—	—	—	—	—	—	—
Fuse size	A	200	200	600	600	1200	1200	2000	2000	—
Short circuit rating with MCCB	kA	25	25	50	50	50	50	65	65	—
Endurances										
Min. Electrical endurance, pf = 0.75 – 0.80	operation cycles	6000	6000	1000	1000	500	500	500	500	400
Min. Electrical endurance, pf = 0.40 – 0.50	operation cycles	1000	②	②	②	②	②	②	②	②
Mechanical endurance	operations	16,000	16,000	10,000	10,000	10,000	10,000	6000	6000	6000
Physical characteristics										
Weight, switches	3 pole lb	6.61	6.61	13.66	13.66	35.9	38.55	127.7	127.7	127.7
	4 pole lb	8.15	8.15	16.74	16.74	45.15	49.56	149.7	149.7	149.7
Dimension, switches	3 pole H in	8.35	8.35	11.81	11.77	19.09	19.09	25.04	25.04	25.04
	W in	7.83	8.62	10.24	11.93	14.29	14.29	18.43	18.43	18.43
	D in	4.55	4.55	5.12	5.12	4.92	4.92	10.67	10.67	10.67
Shaft size — square	□ in	.31 X .31	.31 x .31	.47 x .47	.47 x .47	.47 x .47	.47 x .47	.47 x .47	.47 x .47	.47 x .47
	mm	8 X 8	8 x 8	12 x 12	12 x 12	12 x 12	12 x 12	12 x 12	12 x 12	12 x 12
Switch operating torque for rotary 3 pole switches	lb. in.	71.5	71.5	184	184	184	184	438	438	438
Terminal lug kits										
Wire range	AWG	BDTL25 #6 – 300kcmil ^③	BDTL25 #6-300kcmil ^③	BDTL26 #2-600kcmil	BDTL27 (2)#2-600kcmil	BDTL30 (2)#2-600kcmil	BDTL28 (4)#2-600kcmil	BDTL28 (4)#2-600kcmil	BDTL28/2 (8)#2-600kcmil	BDTL28/2 (8)#2-600kcmil
Torque:										
Wire tightening	lb. in.	375	375	500	375	500	375	375	375	375
Lug mounting	lb. in.	230	230	480	500	230	230	230	230	230
Auxiliary contacts										
NEMA ratings, AC		A600	A600	A600	A600	A600	A600	A600	A600	A600
AC rated voltage	VAC	600	600	600	600	600	600	600	600	600
AC thermal rated current	A	10	10	10	10	10	10	10	10	10
AC maximum volt-ampere making	VA	7200	7200	7200	7200	7200	7200	7200	7200	7200
AC maximum volt-ampere breaking	VA	720	720	720	720	720	720	720	720	720
NEMA ratings, DC		P600	P600	P600	P600	P600	P600	P600	P600	P600
DC rated voltage	VDC	600	600	600	600	600	600	600	600	600
DC thermal rated current	A	5	5	5	5	5	5	5	5	5
DC maximum make-break	VA	138	138	138	138	138	138	138	138	138
Torque:										
Wire tightening	lb. in	7	7	7	7	7	7	7	7	7
Wire range	AWG	#22 – #124	#22 – #14	#22 – #14	#22 – #14	#22 – #14	#22 – #14	#22 – #14	#22 – #14	#22 – #14

① UL Listed switches are also CSA Approved.
 ② UL98 overload test, 50 operations, pf 0.40 – 0.50 at 2x FLA.
 ③ Multi-tap lug available.
 ④ IEC rated only.

Fusible

Non-Fused

Enclosed Fused

Enclosed Non-Fused

for Non-Fusible Disconnect Switches
CDNF16 – CDNF160

IEC

Catalog number	3 pole	CDNF16	CDNF25	CDNF32	CDNF45	CDNF63	CDNF30	CDNF60	CDNF100	CDNF160	
Rated insulation and operation voltage, AC20 and DC20 ^①	40°C 750 V	750	750	750	750	750	750	750	750		
Rated impulse withstand voltage	kV	8	8	8	8	8	8	8	8	12	
Rated thermal current, I _m											
AC 20/DC 20	open ^②	A	25	32	40	63	80	40	63	115	200
	40°C enclosed	A	25	32	40	63	80	40	63	115	160
	60°C enclosed	A	25	32	40	63	80	40	63	115	160
Rated operational currents											
AC 21A	≤500V	A	16	25	32	63	80	40	63	100	160^③
	≤690V	A	16	25	32	63	80	40	63	100	160 ^③
	≤1000V ^①	A	—	—	—	—	—	—	—	—	—
AC 22A	≤500V	A	16	25	32	63	80	40	63	100	160 ^③
	≤690V	A	16	25	32	63	80	40	63	100	160 ^③
	≤1000V ^①	A	—	—	—	—	—	—	—	—	—
AC 23A	≤415V	A	16	20	23	45	75	40	63	80	135
	≤500V	A	16	20	23	45	58	40	63	60	125
	≤690V	A	10	11	12	20	20	40	40	40	80
	≤1000V ^①	A	—	—	—	—	—	—	—	—	—
Rated operational currents/poles in series											
DC21A	48V	A	16/1	25/1	32/1	⊕	⊕	40/1	63/1	100/1	160/1
	110V	A	16/2	25/2	32/2	45/2	63/2	40/2	63/2	100/2	160/1
	220V	A	16/3	25/3	32/3	⊕	⊕	40/4	63/4	100/4	160/2
	440V	A	⊕	⊕	⊕	⊕	⊕	⊕	⊕	⊕	160/3
	750V	A	⊕	⊕	⊕	⊕	⊕	⊕	⊕	⊕	160/4
DC22A	48V	A	16/1	25/1	32/1	⊕	⊕	40/1	63/1	100/1	160/1
	110V	A	16/2	25/2	32/2	45/2	63/2	40/2	63/2	100/2	160/1
	220V	A	16/3	25/3	32/4	⊕	⊕	40/4	63/4	63/4	160/2
	440V	A	⊕	⊕	⊕	⊕	⊕	⊕	⊕	⊕	160/3
	750V	A	⊕	⊕	⊕	⊕	⊕	⊕	⊕	⊕	⊕
DC23A	48V	A	16/1	25/1	32/1	⊕	⊕	40/1	63/1	100/1	160/1
	110V	A	16/2	25/2	32/2	45/2	63/2	40/2	63/2	100/2	160/1
	220V	A	16/4	25/4	32/4	⊕	⊕	40/4	63/4	63/4	160/2
	440V	A	⊕	⊕	⊕	⊕	⊕	⊕	⊕	⊕	160/3
	750V	A	⊕	⊕	⊕	⊕	⊕	⊕	⊕	⊕	⊕
Rated operational power											
AC23A	230V	kW	3	4	5.5	11	22	7.5	11	22	45
	400/415V	kW	7.5	9	11	22	37	15	18.5	37	75
	500V	kW	7.5	9	11	22	37	15	18.5	37	75
	690V	kW	7.5	9	11	15	18.5	15	15	37	75
Short-circuit current	kA	50	50	50	50	50	50	50	50	50	
with back-up fuses of size ^④	A	25	32	40	63	80	100	100	100	200	



Figure 1



Figure 2



Figure 3

① 1000V, IEC 408.

② The ambient air temperature does not exceed +40°C and its average over a period of 24 hours does not exceed +35°C according to IEC 947.

③ IEC 947-3, utilization category B, infrequent operation.

④ Not available at time of printing, please consult factory.

for Non-Fusible Disconnect Switches
BDNF175 – BDNF3150

IEC

Catalog number	3 pole	BDNF175	BDNF200A	BDNF400	BDNF600A	BDNF800A	BDNF1200	BDNF1600	BDNF2000	BDNF3150
Rated insulation and operational voltage, AC20 and DC20 ^①	40°C V	1000	1000	1000	1000	1000	1000	1000	1000	
Rated impulse withstand voltage	kV	12	12	12	12	8	8	8	8	8
Rated thermal current, I _{th}										
AC 20/DC 20	open ^② A	315	315	630	800	1250	1600	2500	2500	3150
	40°C enclosed A	270	270	630	720	1250	1600	2300	2300	2600
	60°C enclosed A	220	220	630	720	1250	1600	2300	2300	2600
Rated operational currents										
AC 21A	≤500V A	250	250	630	800	1250	1600	2500^③	2500^③	3150^③
	≤690V A	250	250	630	800	1250	1600	2500 ^③	2500 ^③	3150 ^③
	≤1000V ^① A	250	250	630	630	—	—	—	—	—
AC 22A	≤500V A	250	250	630	800	1250	1600	1600 ^③	1600 ^③	1600 ^③
	≤690V A	250	250	630	800	—	—	—	—	—
	≤1000V ^① A	250	250	400	400	—	—	—	—	—
AC 23A	≤415V A	250	250	630	720	800	800	800 ^③	800 ^③	800 ^③
	≤500V A	250	250	580	600	800	800	800 ^③	800 ^③	800 ^③
	≤690V A	250	250	350	350	—	—	—	—	—
	≤1000V ^① A	125	125	200	200	—	—	—	—	—
Rated operational currents/poles in series										
DC21A	48V A	250	250	630	800	1250	1600	1600	1600	1600
	110V A	250	250	630	800	1250	1600	1600	1600	1600
	220V A	250/2	250/2	630/2	800/2	1250/2	1600/2	1600/2	1600/2	1600/2
	440V A	250/3	250/3	400/3	500/3	—	—	—	—	—
	750V A	250/4	250/4	—	—	—	—	—	—	—
DC22A	48V A	250	250	630	800	④	④	④	④	④
	110V A	250	250	630	630	④	④	④	④	④
	220V A	250/2	250/2	400/2	500/2	④	④	④	④	④
	440V A	250/3	250/3	400/3	500/3	④	④	④	④	④
	750V A	250/4	250/4	—	—	④	④	④	④	④
DC23A	48V A	250	250	630	800	④	④	④	④	④
	110V A	250	250	630	800	④	④	④	④	④
	220V A	250/2	250/2	630/2	630/2	④	④	④	④	④
	440V A	250/3	250/3	400/3	400/3	④	④	④	④	④
	750V A	250/4	250/4	—	—	④	④	④	④	④
Rated operational power										
AC23A	230V kW	75	75	180	200	250	250	250	250	250
	400/415V kW	132	132	315	355	400	400	400	400	400
	500V kW	160	160	355	400	450	450	450	450	450
	690V kW	200	200	355	355	—	—	—	—	—
Short-circuit current with back-up fuses of size ^①	kA	100	100	80	80	50	50 ^⑤	50 ^④	50 ^④	50 ^④
	A	400	630	800	1000	1250	1250	1250	1250	1250

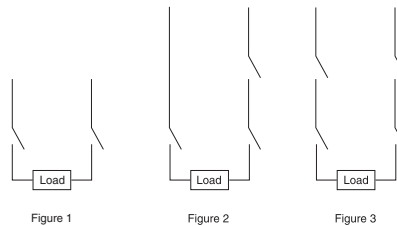

① 1000V, IEC 408.
 ② The ambient air temperature does not exceed +40°C and its average over a period of 24 hours does not exceed +35°C according to IEC 947.
 ③ IEC 947-3, utilization category B, infrequent operation.
 ④ Not available at time of printing, please consult factory.

Fusible

Non-Fused

Enclosed Fused

Enclosed Non-Fused

for Non-Fusible Disconnect Switches
CDNF16 – CDNF160

IEC

Catalog number	3 pole	CDNF16	CDNF25	CDNF32	CDNF45	CDNF63	CDNF30	CDNF60	CDNF100	CDNF160
Rated voltage, U _e	V/V	415	415	415	415	415	415	415	415	415/690
Rated conditional short-circuit current	kA	50	50	50	50	50	50	50	50	80/50
Max. allowed fuse size, type OFAA	A	16	32	40	63	80	100	100	100	160/250
Max. allowed cut-off current, peak value	kA	4	4.3	4.6	8.3	11	9.2	9.2	9.2	21.0/21.6
Rated short-circuit making capacity, prospective peak value, I _{cm}	kA	0.7	0.7	1.4	1.4	3.6	3.6	3.6	12	
Rated short time withstand current, RMS I ^{cw}										
0.2s	kA	—	—	—	—	—	—	—	—	7
1.0s	kA	0.5	0.5	0.5	1	1	2.5	2.5	2.5	4
AC breaking capacity										
pf = 0.35										
≤415V	A	128	160	184	240	304	320	504	640	1080
≤500V	A	128	160	184	240	256	320	504	504	1000
≤690V	A	80	88	96	160	160	320	320	320	640
≤1000V ^①	A	—	—	—	—	—	—	—	—	—
DC breaking capacity/poles in series										
L/R = 15ms, 3 pole in series										
≤48V	A	64/1	100/1	128/1	180/1	252/1	160/1	252/1	400/1	640/1
≤110V	A	64/2	100/2	128/2	180/2	180/2	160/2	252/2	400/2	640/1
≤220V	A	64/3	100/4	128/4	180/4	180/4	160/4	252/4	252/4	640/2
≤440V	A	②	②	②	②	②	②	②	—	640/3
≤750V	A	②	②	②	②	②	②	②	—	—
Capacitor ratings	≤400/415V	kVar	②	②	②	②	②	②	②	②
Rated capacitor duty		kA	②	②	②	②	②	②	②	②
Physical characteristics										
Electrical endurance at rated operational current, pf = 0.65	operation cycles	3000	3000	3000	3000	3000	3000	3000	3000	1000
Mechanical endurance	operations	20,000	20,000	20,000	20,000	20,000	20,000	20,000	20,000	16,000
Weight	3 pole	kg	0.11	0.11	0.11	0.27	0.27	0.36	0.36	1.1
	4 pole	kg	0.15	0.15	0.15	0.35	0.35	0.5	0.5	1.3
Dimension 3 pole	H mm	68	68	91.5	91.5	100	100	100	127	
	W mm	35	35	35	52.5	52.5	70	70	70	126
	D mm	56	56	56	72.5	72.5	75	75	75	74.5
Power loss per pole	W	0.3	0.6	1	1.4	2.8	1	1.6	4	6.5
Shaft size — square □	mm	5 X 5	5 x 5	5 x 5	5 x 5	5 x 5	5 x 5	5 x 5	5 x 5	6 x 6
Switch operating torque for rotary 3 pole switches	Nm	1	1	1	1.2	1.2	2	2	2	6
Suitable conductor cross section Cu	mm ²	0.75 – 10	0.75 – 10	0.75 – 10	1.5 – 35	1.5 – 35	1.5 – 25	1.5 – 25	1.5 – 25	10 – 70
Bolt size		—	—	—	—	—	—	—	—	—
Auxiliary contacts		CDAUX_ _	CDAUX_ _	CDAUX_ _	CDAUX_ _	CDAUX_ _	CDAUX_ _	CDAUX_ _	CDAUX_ _	CDAUX_ _
Ratings according to IEC 9-47-5-1										
Rated voltage, U _i	VAC	690	690	690	690	690	690	690	690	690
Thermal current, I _m	A	16	16	16	16	16	16	16	16	10
AC12/DC12 I _n , A U _e =										
120V	A	—	—	—	—	—	—	—	—	8/—
125V	A	—	—	—	—	—	—	—	—	—/1.1
240V	A	6 ^③	6 ^③	6 ^③	6 ^③	6 ^③	6 ^③	6 ^③	6 ^③	6/—
250V	A	—	—	—	—	—	—	—	—	—/0.55
400V	A	4 ^③	4 ^③	4 ^③	4 ^③	4 ^③	4 ^③	4 ^③	4 ^③	4/—
415V	A	—	—	—	—	—	—	—	—	4/—
440V	A	—	—	—	—	—	—	—	—	—/0.31
480V	A	—	—	—	—	—	—	—	—	3/—
500V	A	—	—	—	—	—	—	—	—	3/0.27
600V	A	—	—	—	—	—	—	—	—	—/0.2
690V	A	2 ^③	2 ^③	2 ^③	2 ^③	2 ^③	2 ^③	2 ^③	2 ^③	2/—

Fusible

Non-Fused

Enclosed Fused

Enclosed Non-Fused

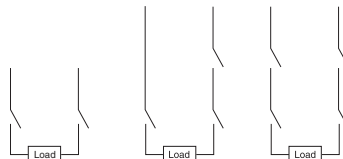

① 1000V, IEC 408.
② Not available at time of printing, please consult factory.
③ AC15, according to IEC947-5-1.

for Non-Fusible Disconnect Switches
BDNF175 – BDNF3150

IEC

Catalog number	3 pole	BDNF175	BDNF200A	BDNF400	BDNF600A	BDNF800A	BDNF1200	BDNF1600	BDNF2000	BDNF3150
Rated voltage, U _e	V/V	500/690	500/690	500/690	500/690	690	690	690	690	690
Rated conditional short-circuit current	kA	100/50	100/50	100/50	100/50	45	45	45	50	50
Max. allowed fuse size, type OFAA	A	400	400	800 ^③	800 ^③	—	—	—	—	—
Max. allowed cut-off current, peak value	kA	30	30	62	62	—	—	—	—	—
Rated short-circuit making capacity, prospective peak value, I _{sm}	kA	35	80	80	105	105	115	115	115	—
Rated short time withstand current,										
RMS I _{sw} 0.2s	kA	17	17	38	38	100	100	110	110	110
RMS I _{sw} 1.0s	kA	8	8	17	17	50 ^⑤	50 ^⑤	50 ^⑤	50 ^⑤	50 ^⑤
AC breaking capacity										
pf = 0.35										
≤415V	A	1600	2000	5760	5780	6400	6400	6400	6400	6400
≤500V	A	1600	2000	4800	4800	6400	6400	6400	6400	6400
≤690V	A	1600	2000	2800	2800	2500 ^⑥	2500 ^⑥	4800 ^⑦	4800 ^⑦	4800 ^⑦
≤1000V ^①	A	1000	1000	1200	1200	—	—	—	—	—
DC breaking capacity/poles in series										
L/R = 15ms, 3 pole in series										
48V	A	1260/1	1260/1	—	—	—	—	—	—	—
110V	A	1260/1	1260/1	—	—	—	—	—	—	—
220V	A	1260/2	1260/2	1600/2	2000/2	1900/2 ^④	2600/2 ^④	2600/2 ^④	2600/2 ^④	2600/2 ^④
440V	A	1260/1	1260	1600	2000	—	—	—	—	—
750V	A	1260/1	1260/4	—	—	—	—	—	—	—
Capacitor ratings	400/415V kVar	90	110	300	350	②	②	②	②	②
Rated capacitor duty	kA	135	170	450	500	②	②	②	②	②
Physical characteristics										
Electrical endurance at rated operational current, pf = 0.65	operation cycles	1000	1000	1000	500	500	500	100 ^⑧	100 ^⑧	100 ^⑧
Mechanical endurance	operations	16,000	16,000	10,000	10,000	10,000	10,000	6000	6000	6000
Weight	3 pole kg	3.0	3.0	6.2	6.2	16.3	17.5	37	37	37
	4 pole kg	3.7	3.7	7.6	7.6	20.5	22.5	47	47	47
Dimension	3 pole H mm	212	300	299	485	485	636	636	636	636
	W mm	199	219	260	303	363	363	468	468	468
	D mm	115.5	115.5	130	130	125	125	271	271	271
Power loss per one pole	W	3.5	5.5	22	40	40	67	90	90	140
Shaft size — square □	mm	8 x 8	8 x 8	12 x 12	12 x 12	12 x 12	12 x 12	12 x 12	12 x 12	12 x 12
Switch operating torque for rotary 3 pole switches	Nm	8.2	8.2	21	21	21	21	50	50	50
Suitable conductor cross section Cu	mm ²	—	—	—	—	—	—	—	—	—
Bolt size		8x25	10 x 30	12 x 40	12 x 40	12 x 60	12 x 60	12 x 60	12 x 60	12 x 60
Auxiliary contacts		BDAUX_ _	BDAUX_ _	BDAUX_ _	BDAUX_ _	BDAUX_ _	BDAUX_ _	BDAUX_ _	BDAUX_ _	BDAUX_ _
Ratings according to IEC 947-5-1										
Rated voltage, U _i	VAC	690	690	690	690	690	690	690	690	690
Thermal rated current, I _n	A	10	10	10	10	10	10	10	10	10
AC12/DC12 I _n , A U _e =										
120V	A	8/—	8/—	8/—	8/—	8/—	8/—	8/—	8/—	8/—
125V	A	—/1.1	—/1.1	—/1.1	—/1.1	—/1.1	—/1.1	—/1.1	—/1.1	—/1.1
240V	A	6/—	6/—	6/—	6/—	6/—	6/—	6/—	6/—	6/—
250V	A	—/0.55	—/0.55	—/0.55	—/0.55	—/0.55	—/0.55	—/0.55	—/0.55	—/0.55
400V	A	4/—	4/—	4/—	4/—	4/—	4/—	4/—	4/—	4/—
415V	A	4/—	4/—	4/—	4/—	4/—	4/—	4/—	4/—	4/—
440V	A	—/0.31	—/0.31	—/0.31	—/0.31	—/0.31	—/0.31	—/0.31	—/0.31	—/0.31
480V	A	3/—	3/—	3/—	3/—	3/—	3/—	3/—	3/—	3/—
500V	A	3/0.27	3/0.27	3/0.27	3/0.27	3/0.27	3/0.27	3/0.27	3/0.27	3/0.27
600V	A	—/0.2	—/0.2	—/0.2	—/0.2	—/0.2	—/0.2	—/0.2	—/0.2	—/0.2
690V	A	2/—	2/—	2/—	2/—	2/—	2/—	2/—	2/—	2/—

- ① 1000V, IEC 408.
- ② Not available at time of printing, please consult factory.
- ③ Size 4.
- ④ L/R = 2.5 mS.
- ⑤ Maximum distance between busbar support and switch terminal 70mm.
- ⑥ pf 0.95.
- ⑦ pf 0.65.
- ⑧ IEC 947-3, utilization category B, infrequent operation.

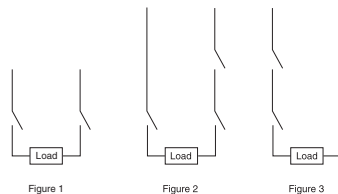

Fusible

Non-Fused

Enclosed Fused

Enclosed Non-Fused

for Non-Fusible Disconnect Switches
CDNF16 — CDNF100

CDNF16, CDNF25, CDNF32 — base & DIN rail mounted switch

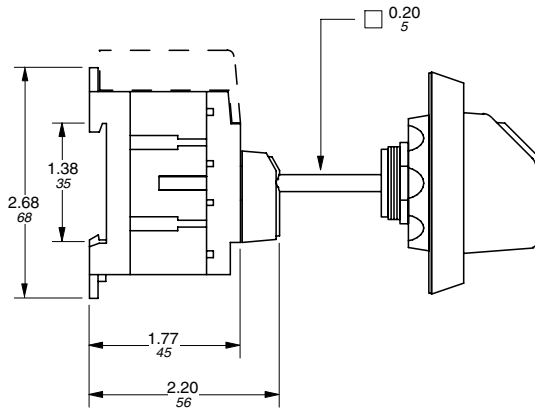
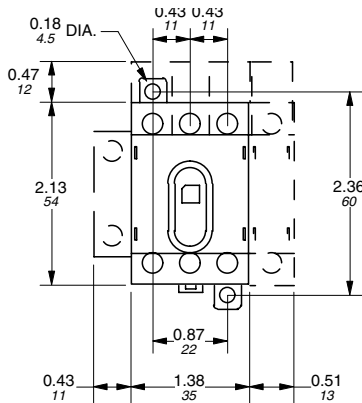

Fusible

CDNF45, CDNF63 — base & DIN rail mounted switch

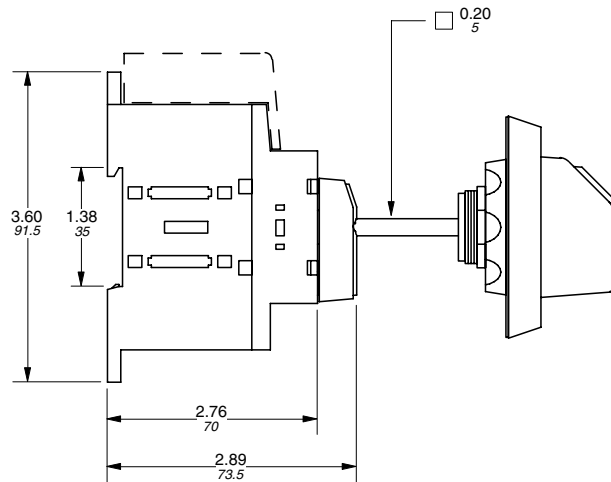
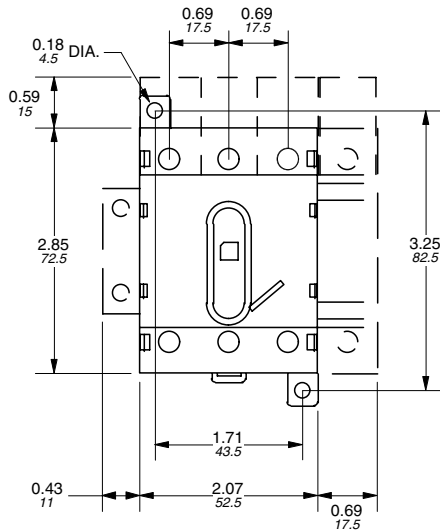

Non-Fused

Enclosed Fused

CDNF30, CDNF60, CDNF100 — base & DIN rail mounted switch

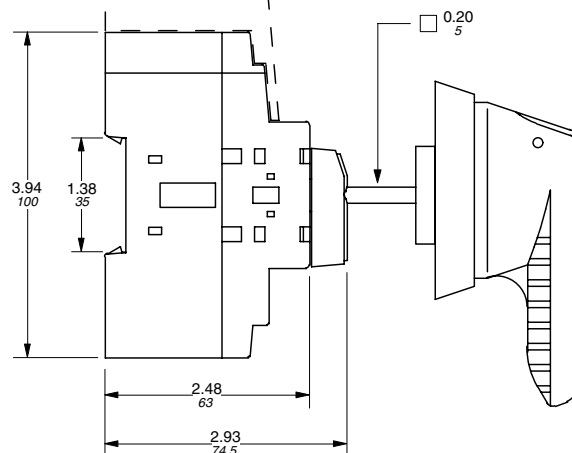
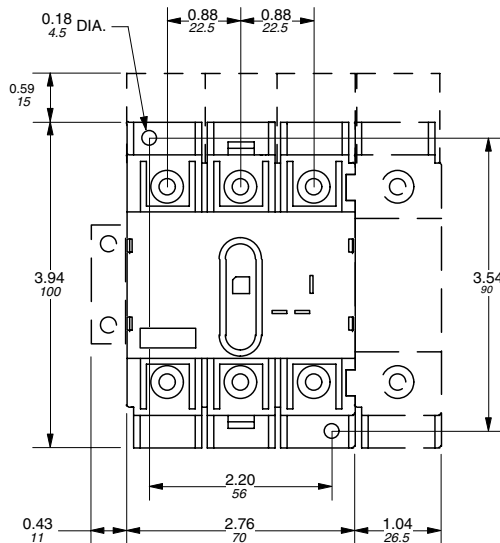

Enclosed Non-Fused

for Non-Fusible Disconnect Switches
CDNF16D — CDNF100D

CDNF16D, CDNF25D, CDNF32D — door mounted switch

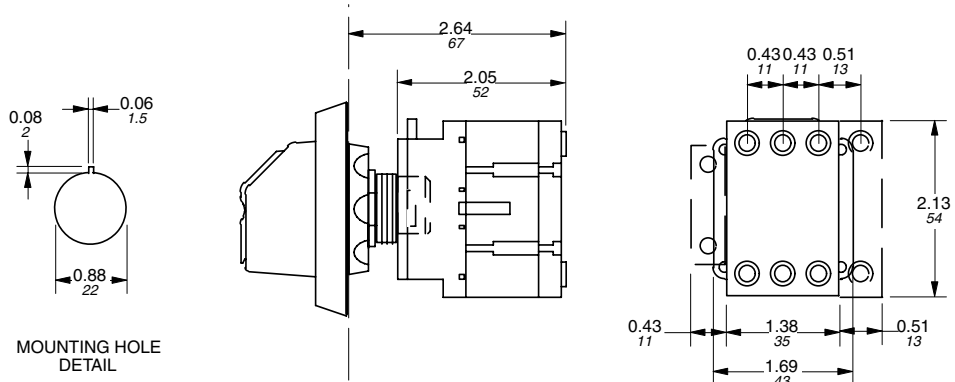

CDNF45D, CDNF63D — door mounted switch

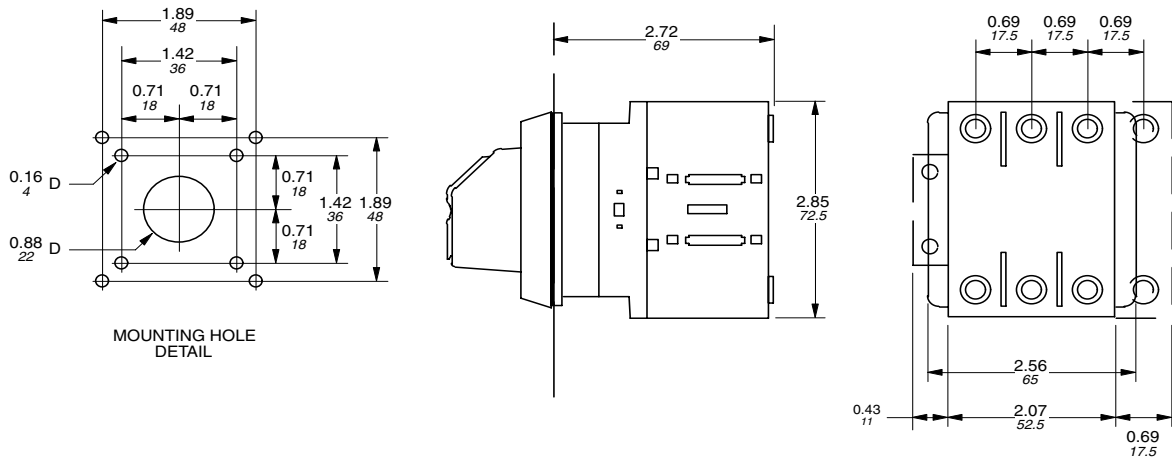

CDNF30D, CDNF60D, CDNF100D — door mounted switch

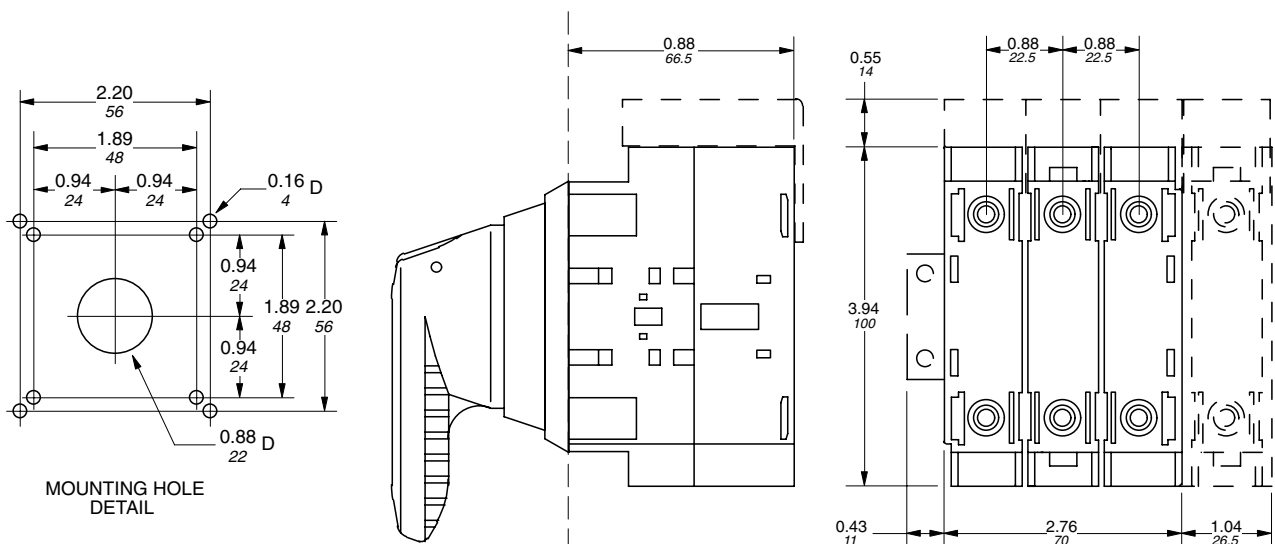

Fusible

Non-Fused

Enclosed Fused

Enclosed Non-Fused

for Non-Fusible Disconnect Switches
CDNF175A — BDNF200A

CDNF175A

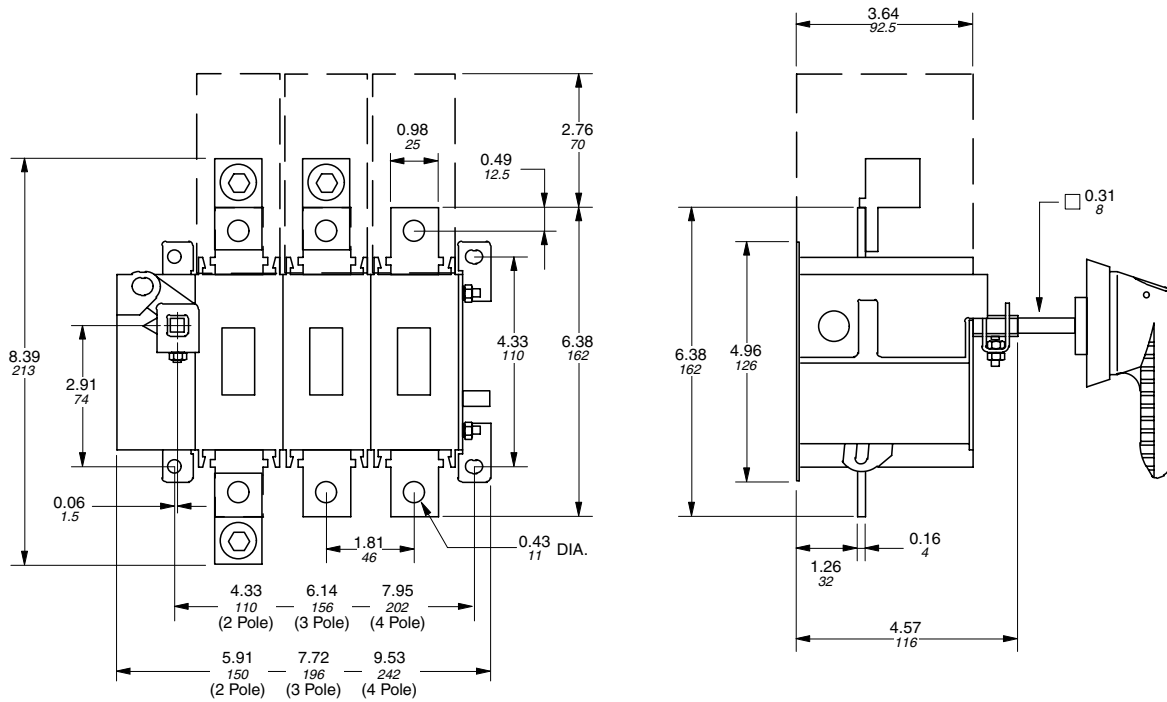

BDNF200A

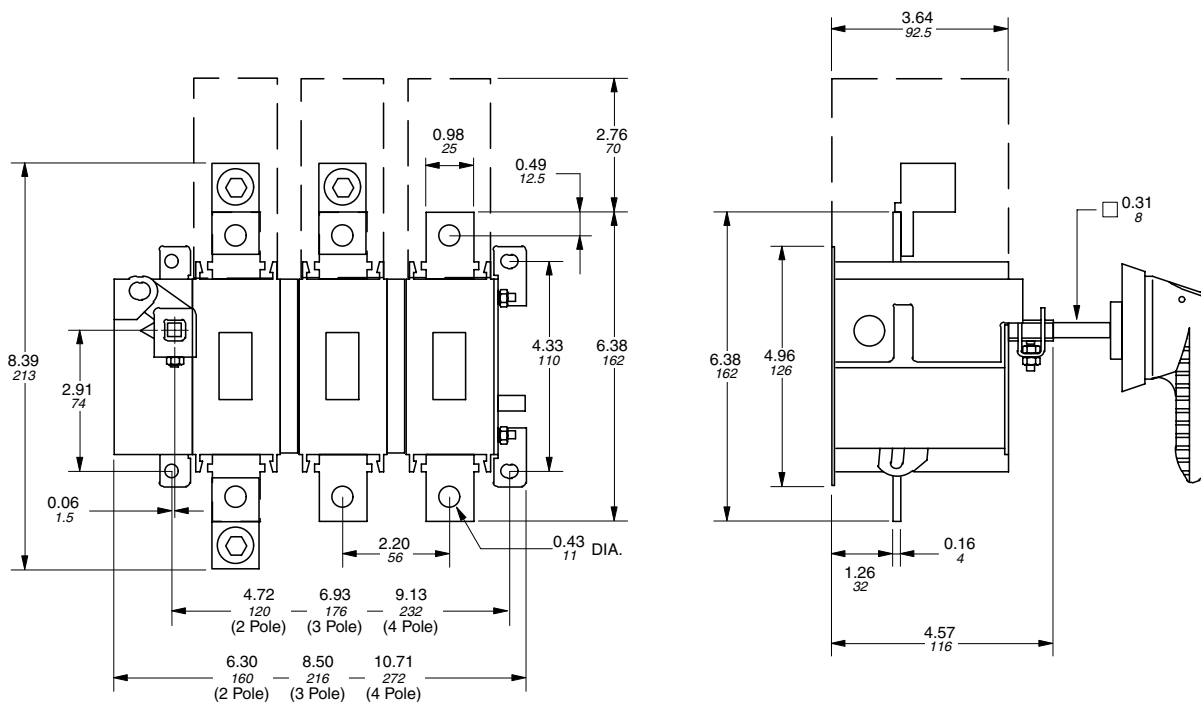

for Non-Fusible Disconnect Switches

BDNF400

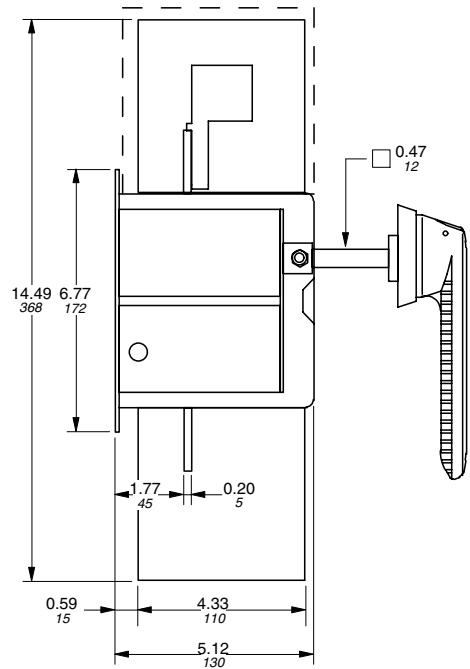
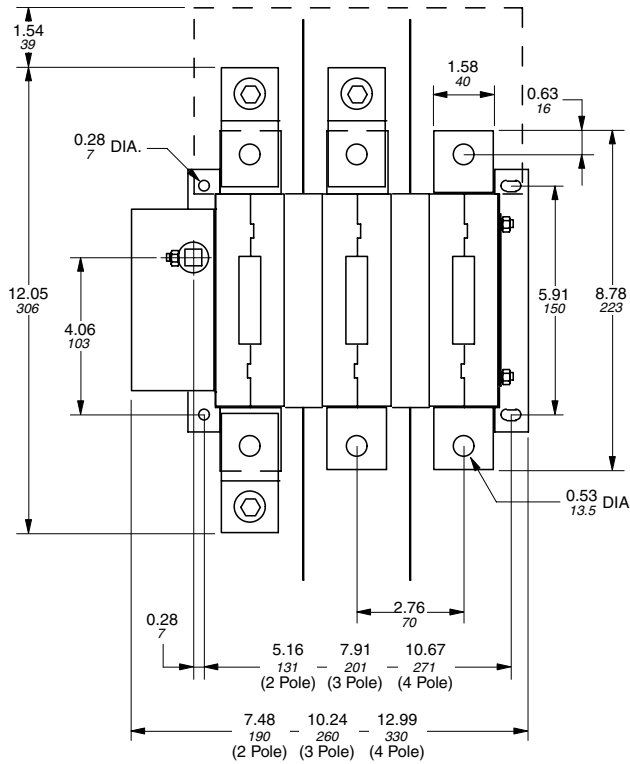

BDNF600A

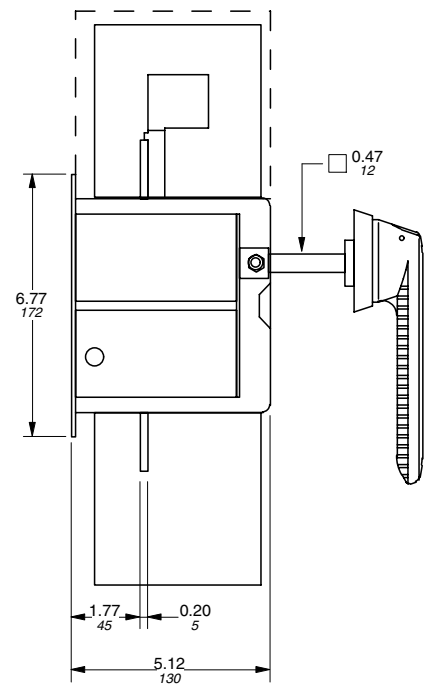
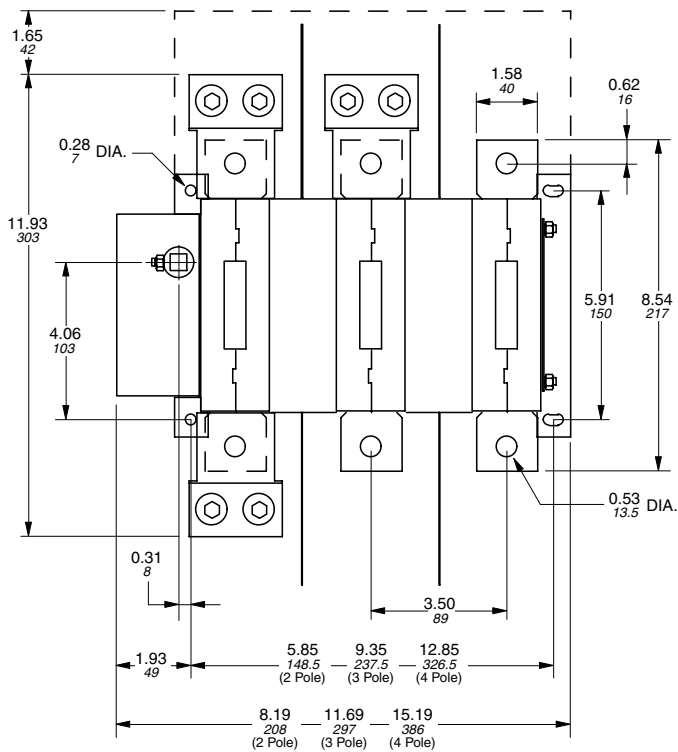

Fusible

Non-Fused

Enclosed Fused

Enclosed Non-Fused

for Non-Fusible Disconnect Switches
BDNF800A — BDNF1200

BDNF800A

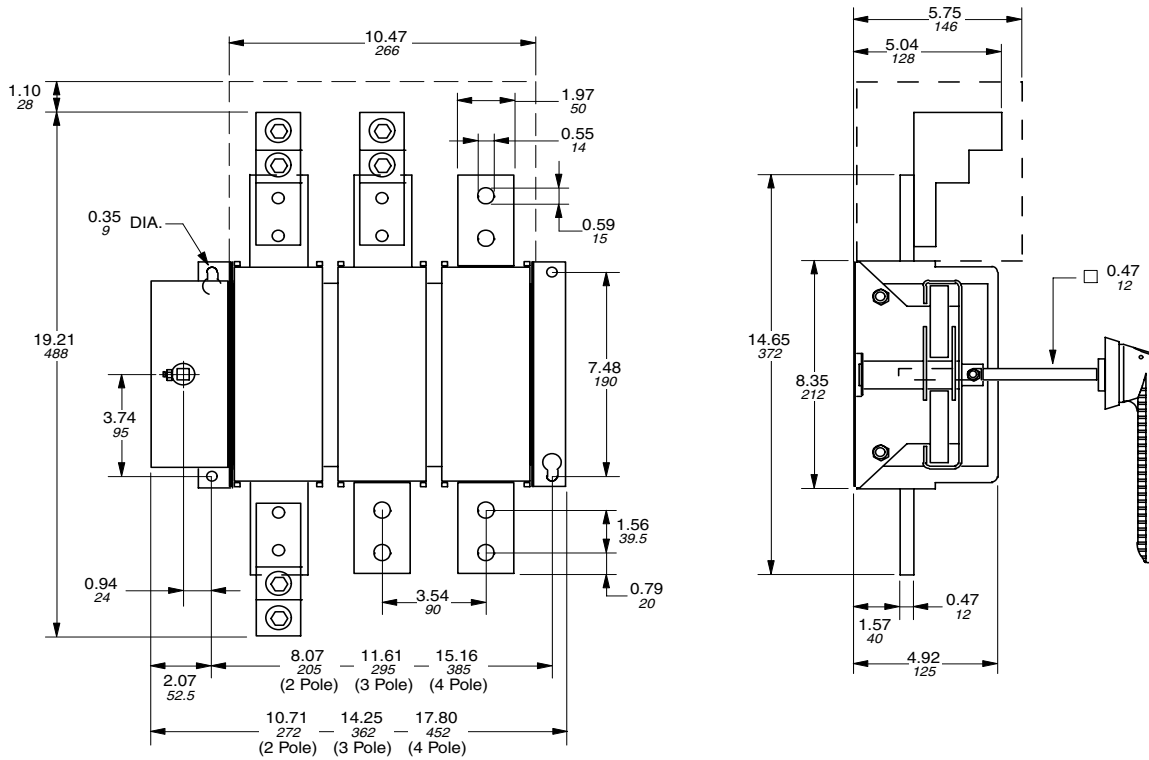

BDNF1200

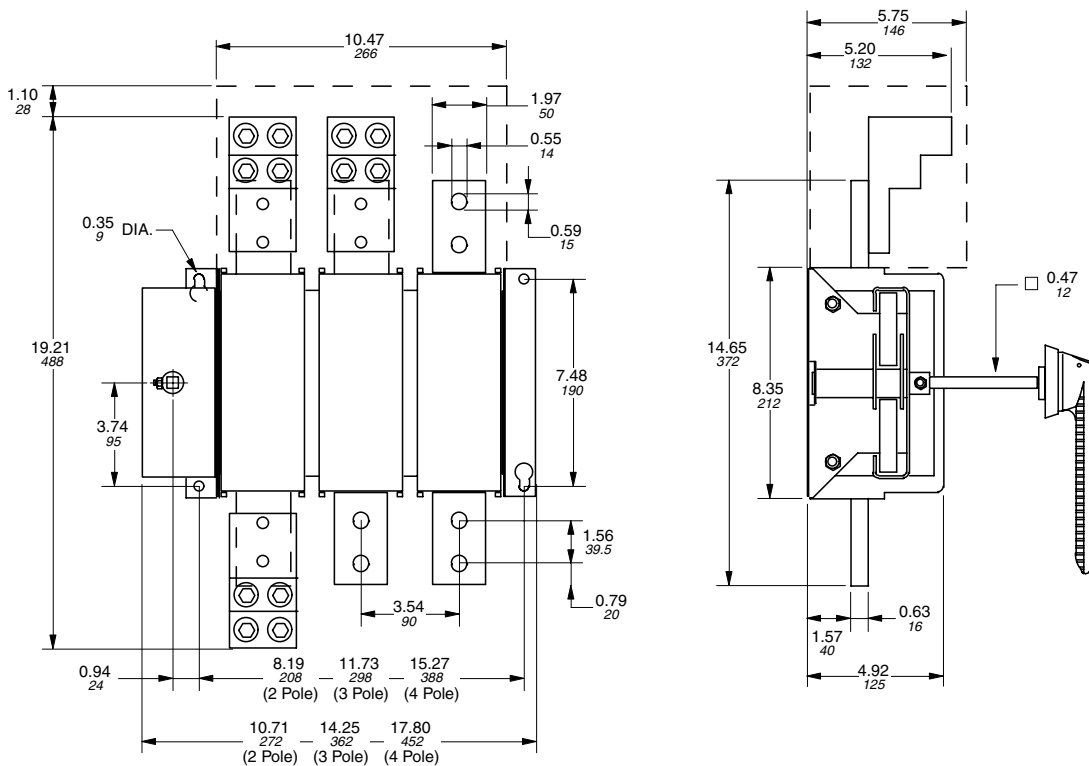

for Non-Fusible Disconnect Switches
BDNF1600 — BDNF3150

BDNF1600

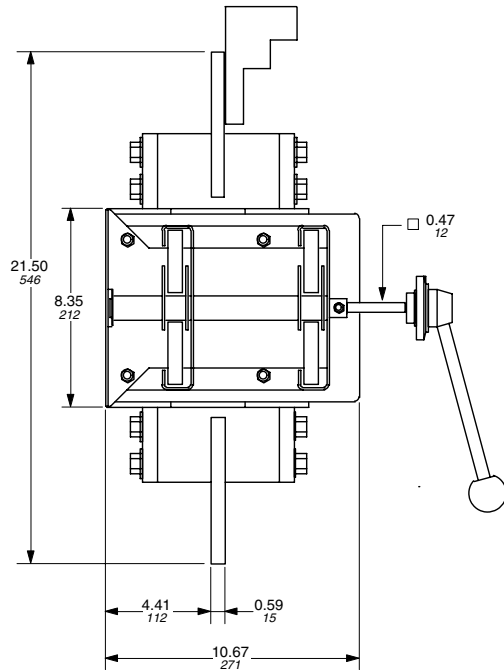
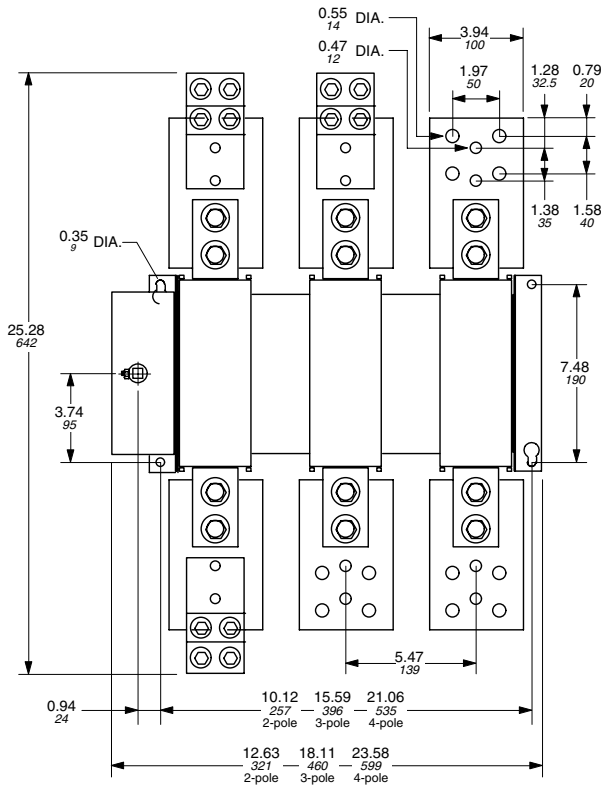

BDNF2000 — BDNF3150

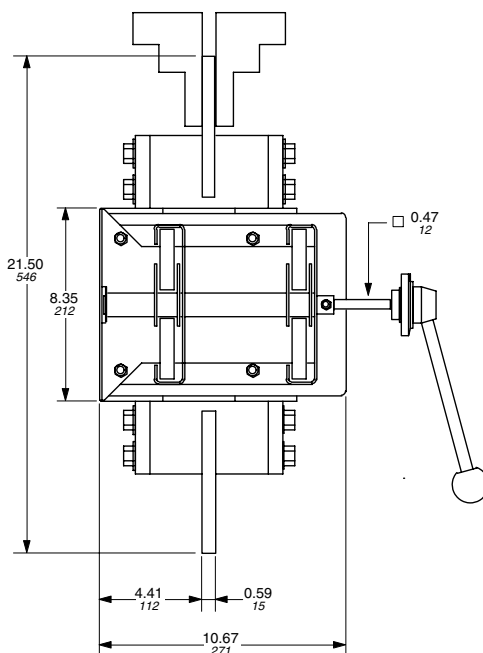
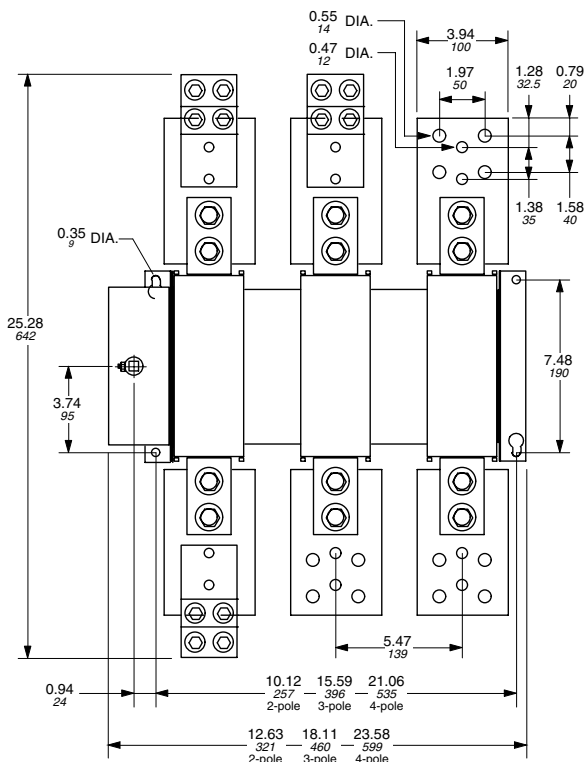

Fusible

Non-Fused

Enclosed Fused

Enclosed Non-Fused

Approximate Dimensions for Terminal Lugs

Bussmann®

BDTL25 — for use with 175A – 200A switches

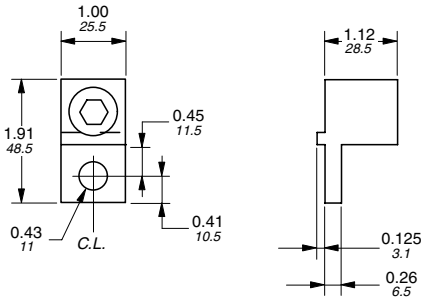

BDTL27 — for use with 600A switches

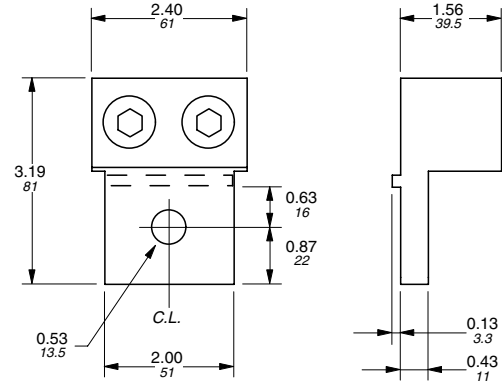

Fusible

Non-Fused

BDTL175 — for use with 175A – 200A switches

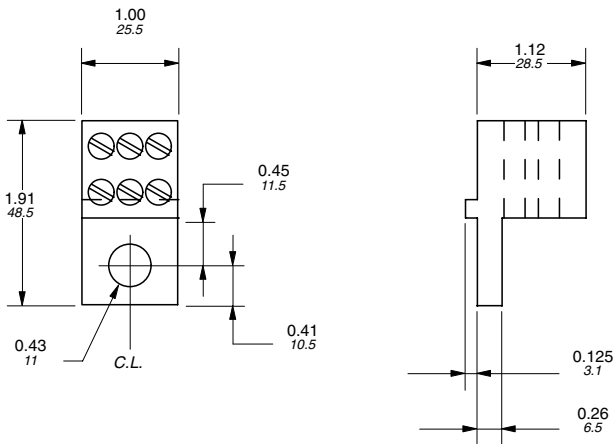

BDTL30 — for use with 800A switches

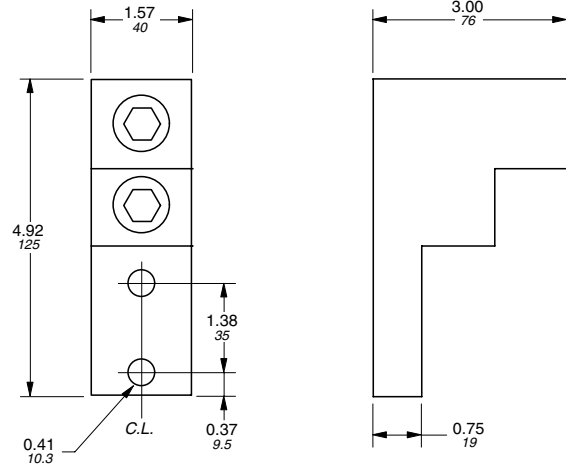

Enclosed Fused

Enclosed Non-Fused

BDTL26 — for use with 400A switches

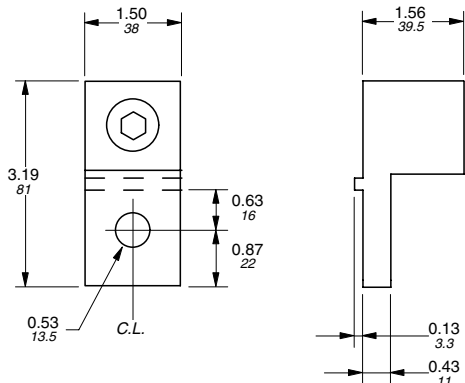

BDTL28 & BDTL28/2 — for use with 1200A – 3150A switches

