



P-Channel JFETs

J174	SST174
J175	SST175
J176	SST176
J177	SST177

PRODUCT SUMMARY				
Part Number	V _{GS(off)} (V)	r _{DS(on)} Max (Ω)	I _{D(off)} Typ (pA)	t _{ON} Typ (ns)
J/SST174	5 to 10	85	-10	25
J/SST175	3 to 6	125	-10	25
J/SST176	1 to 4	250	-10	25
J/SST177	0.8 to 2.25	300	-10	25

FEATURES

- Low On-Resistance: J174 <85 Ω
- Fast Switching—t_{ON}: 25 ns
- Low Leakage: -10 pA
- Low Capacitance: 5 pF
- Low Insertion Loss

BENEFITS

- Low Error Voltage
- High-Speed Analog Circuit Performance
- Negligible “Off-Error,” Excellent Accuracy
- Good Frequency Response
- Eliminates Additional Buffering

APPLICATIONS

- Analog Switches
- Choppers
- Sample-and-Hold
- Normally “On” Switches
- Current Limiters

DESCRIPTION

The J/SST174 series consists of p-channel analog switches designed to provide low on-resistance and fast switching. This series simplifies series-shunt switching applications when combined with the Siliconix J/SST111 series.

The TO-226AA (TO-92) plastic package provides a low-cost option, while the TO-236 (SOT-23) package provides surface-mount capability. Both the J and SST series are available in tape-and-reel for automated assembly (see Packaging Information).

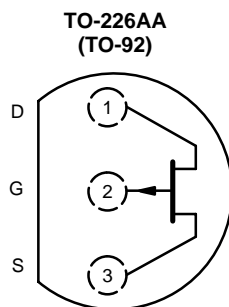

Top View

- J174
- J175
- J176
- J177

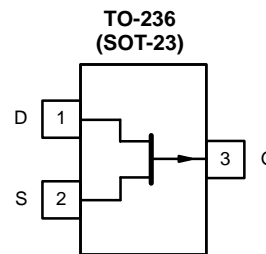

Top View

- SST174 (S4)*
- SST175 (S5)*
- SST176 (S6)*
- SST177 (S7)*

*Marking Code for TO-236

For applications information see AN104.



ABSOLUTE MAXIMUM RATINGS

Gate-Drain Voltage 30 V
 Gate-Source Voltage 30 V
 Gate Current -50 mA
 Storage Temperature -55 to 150°C
 Operating Junction Temperature -55 to 150°C

Lead Temperature (1/16" from case for 10 sec.) 300°C
 Power Dissipation^a 350 mW

Notes
 a. Derate 2.8 mW/°C above 25°C

SPECIFICATIONS FOR J/SST174 AND J/SST175 (T _A = 25°C UNLESS OTHERWISE NOTED)								
Parameter	Symbol	Test Conditions	Typ ^a	Limits				Unit
				J/SST174		J/SST175		
				Min	Max	Min	Max	
Static								
Gate-Source Breakdown Voltage	V _{(BR)GSS}	I _G = 1 μA, V _{DS} = 0 V	45	30		30		V
Gate-Source Cutoff Voltage	V _{GS(off)}	V _{DS} = -15 V, I _D = -10 nA		5	10	3	6	
Saturation Drain Current ^b	I _{DSS}	V _{DS} = -15 V, V _{GS} = 0 V		-20	-135	-7	-70	mA
Gate Reverse Current	I _{GSS}	V _{GS} = 20 V, V _{DS} = 0 V T _A = 125°C	0.01 5		1		1	nA
Gate Operating Current	I _G	V _{DG} = -15 V, I _D = -1 mA	0.01					
Drain Cutoff Current	I _{D(off)}	V _{DS} = -15 V, V _{GS} = 10 V T _A = 125°C	-0.01 -5		-1		-1	
Drain-Source On-Resistance	r _{DS(on)}	V _{GS} = 0 V, V _{DS} = -0.1 V			85		125	Ω
Gate-Source Forward Voltage	V _{GS(F)}	I _G = -1 mA, V _{DS} = 0 V	-0.7					V
Dynamic								
Common-Source Forward Transconductance	g _{fs}	V _{DS} = -15 V, I _D = -1 mA f = 1 kHz	4.5					mS
Common-Source Output Conductance	g _{os}		20					μS
Drain-Source On-Resistance	r _{ds(on)}	V _{GS} = 0 V, I _D = 0 mA, f = 1 kHz			85		125	Ω
Common-Source Input Capacitance	C _{iss}	V _{DS} = 0 V, V _{GS} = 0 V, f = 1 MHz	20					pF
Common-Source Reverse Transfer Capacitance	C _{rss}	V _{DS} = 0 V, V _{GS} = 10 V f = 1 MHz	5					
Equivalent Input Noise Voltage	e _n	V _{DG} = -10 V, I _D = -1 mA f = 1 kHz	20					nV/ √Hz
Switching								
Turn-On Time	t _{d(on)}	V _{GS(L)} = 0 V, V _{GS(H)} = 10 V See Switching Circuit	10					ns
	t _r		15					
Turn-Off Time	t _{d(off)}		10					
	t _f		20					

Notes
 a. Typical values are for DESIGN AID ONLY, not guaranteed nor subject to production testing.
 b. Pulse test: PW ≤ 300 μs duty cycle ≤ 3%.

PSCIA



SPECIFICATIONS FOR J/SST176 AND J/SST177 (T _A = 25 °C UNLESS OTHERWISE NOTED)								
Parameter	Symbol	Test Conditions	Typ ^a	Limits				Unit
				J/SST176		J/SST177		
				Min	Max	Min	Max	
Static								
Gate-Source Breakdown Voltage	V _{(BR)GSS}	I _G = 1 μA, V _{DS} = 0 V	45	30		30		V
Gate-Source Cutoff Voltage	V _{GS(off)}	V _{DS} = -15 V, I _D = -10 nA		1	4	0.8	2.25	
Saturation Drain Current ^b	I _{DSS}	V _{DS} = -15 V, V _{GS} = 0 V		-2	-35	-1.5	-20	mA
Gate Reverse Current	I _{GSS}	V _{GS} = 20 V, V _{DS} = 0 V T _A = 125 °C	0.01		1		1	nA
			5					
Gate Operating Current	I _G	V _{DG} = -15 V, I _D = -1 mA	0.01					nA
Drain Cutoff Current	I _{D(off)}	V _{DS} = -15 V, V _{GS} = 10 V T _A = 125 °C	-0.01		-1		-1	nA
			-5					
Drain-Source On-Resistance	r _{DS(on)}	V _{GS} = 0 V, V _{DS} = -0.1 V			250		300	Ω
Gate-Source Forward Voltage	V _{GS(F)}	I _G = -1 mA, V _{DS} = 0 V	-0.7					V
Dynamic								
Common-Source Forward Transconductance	g _{fs}	V _{DS} = -15 V, I _D = -1 mA f = 1 kHz	4.5					mS
Common-Source Output Conductance	g _{os}		20					μS
Drain-Source On-Resistance	r _{ds(on)}	V _{GS} = 0 V, I _D = 0 mA, f = 1 kHz			250		300	Ω
Common-Source Input Capacitance	C _{iss}	V _{DS} = 0 V, V _{GS} = 0 V, f = 1 MHz	20					pF
Common-Source Reverse Transfer Capacitance	C _{rss}	V _{DS} = 0 V, V _{GS} = 10 V f = 1 MHz	5					
Equivalent Input Noise Voltage	e _n	V _{DG} = -10 V, I _D = -1 mA f = 1 kHz	20					nV/ √Hz
Switching								
Turn-On Time	t _{d(on)}	V _{GS(L)} = 0 V, V _{GS(H)} = 10 V See Switching Circuit	10					ns
	t _r		15					
Turn-Off Time	t _{d(off)}		10					
	t _f		20					

Notes

- a. Typical values are for DESIGN AID ONLY, not guaranteed nor subject to production testing.
- b. Pulse test: PW ≤ 300 μs duty cycle ≤ 3%.

PSCIA

TYPICAL CHARACTERISTICS ($T_A = 25^\circ\text{C}$ UNLESS OTHERWISE NOTED)

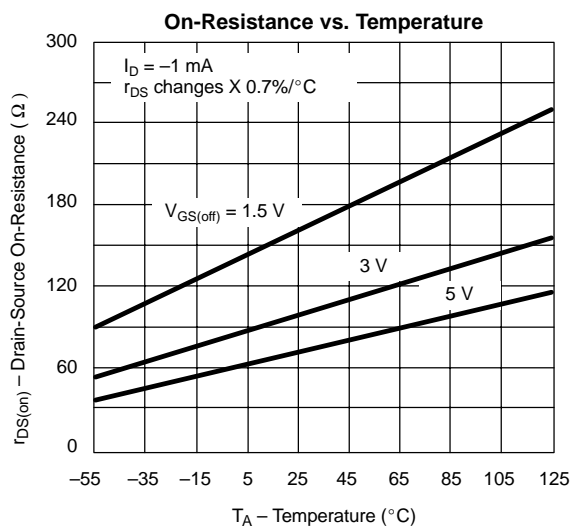
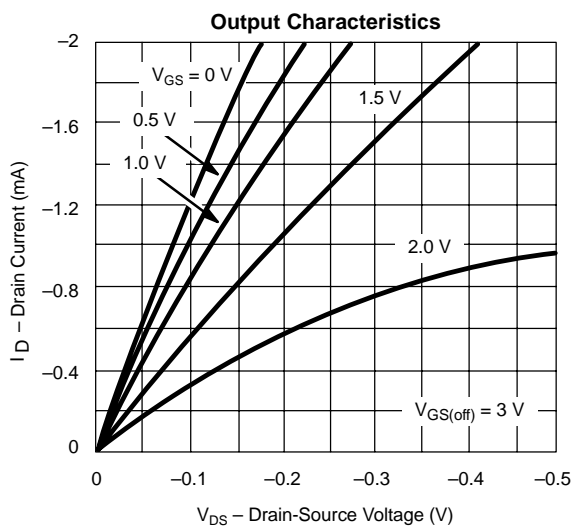
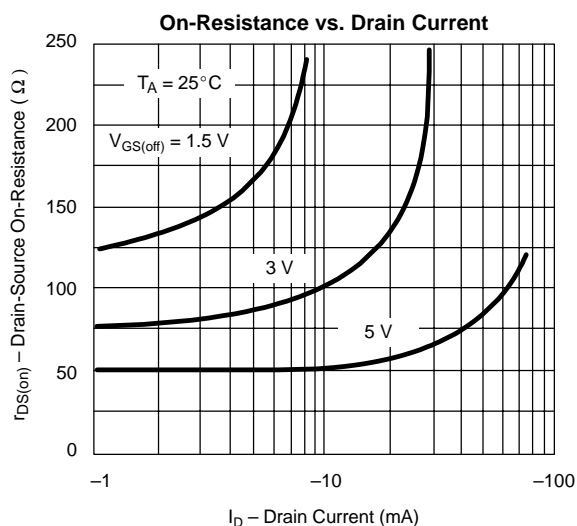
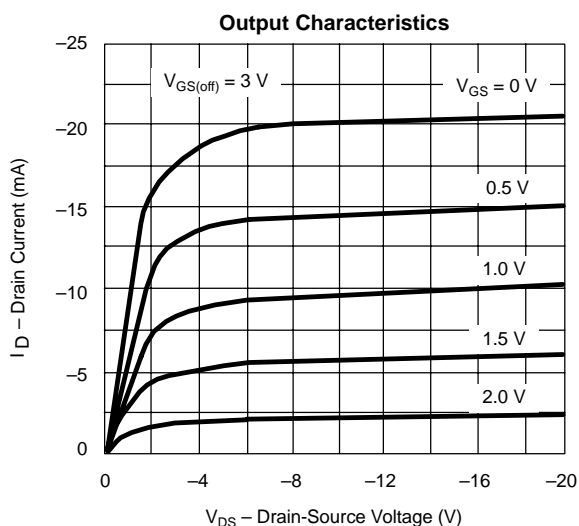
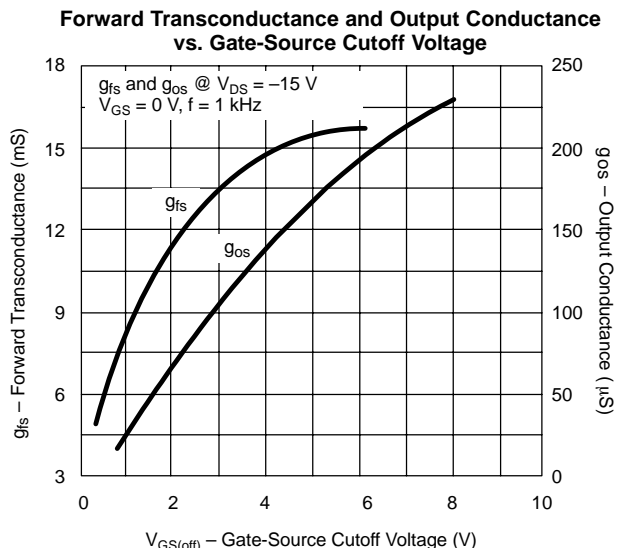
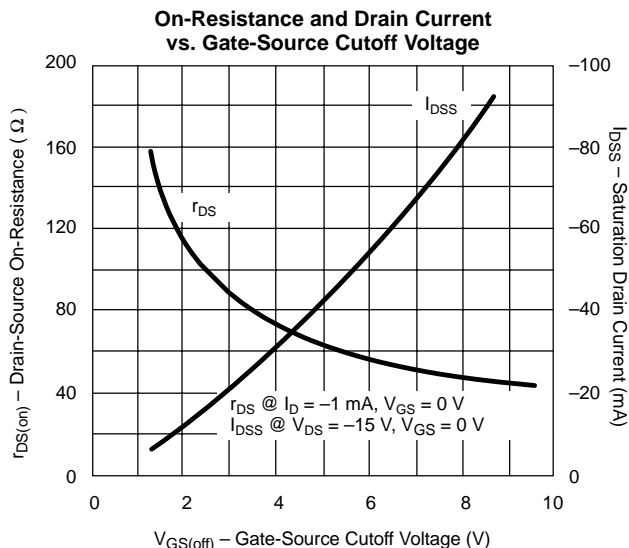

TYPICAL CHARACTERISTICS ($T_A = 25^\circ\text{C}$ UNLESS OTHERWISE NOTED)

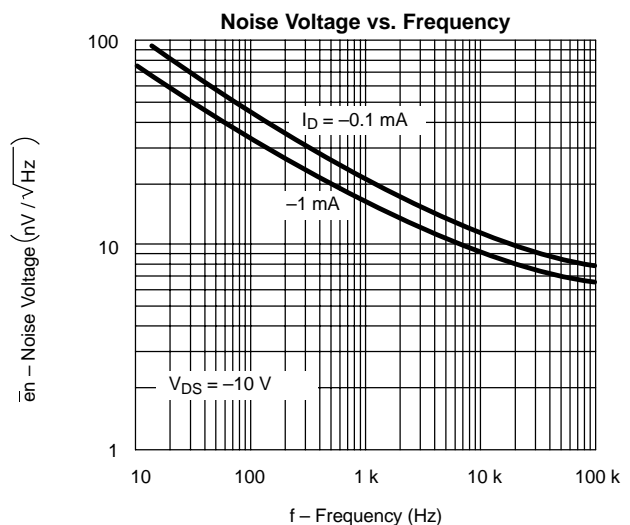
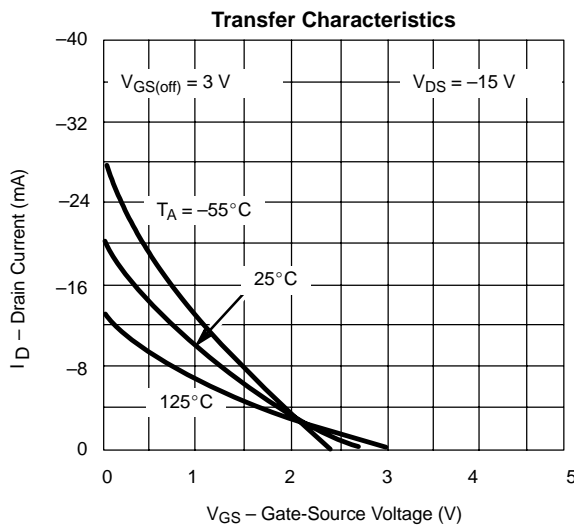
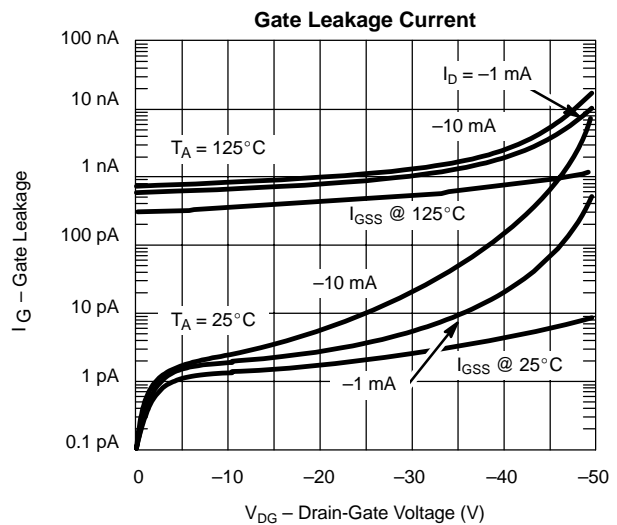
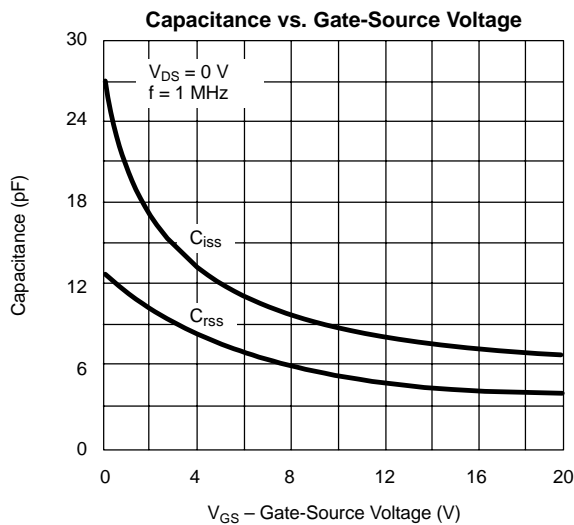
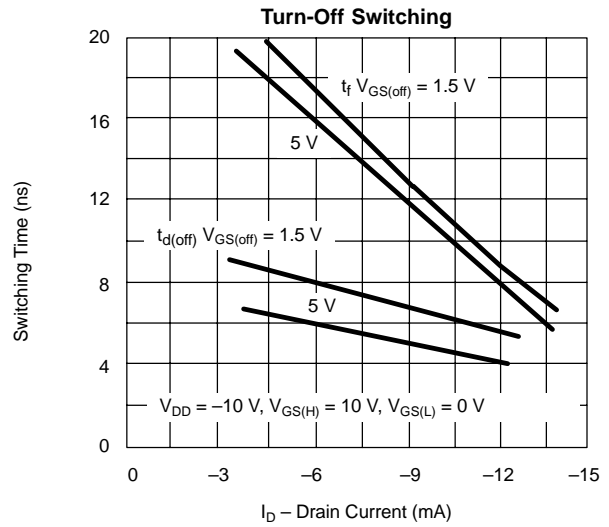
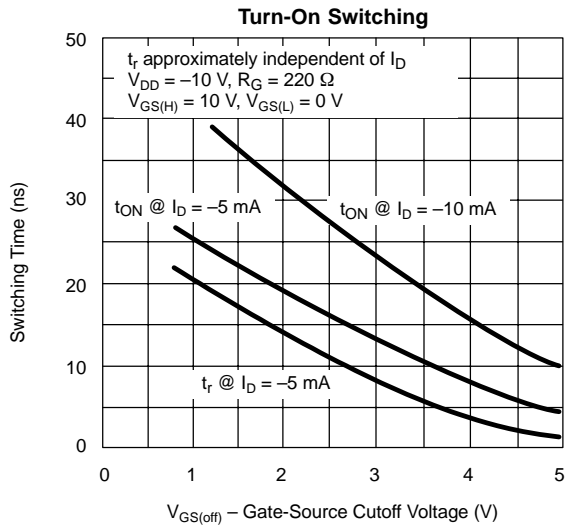

SWITCHING TIME TEST CIRCUIT				
	174	175	176	177
V_{DD}	-10 V	-6 V	-6 V	-6 V
V_{GG}	20 V	12 V	8 V	5 V
R_L^*	560 Ω	750 Ω	1800 Ω	5600 Ω
R_G^*	100 Ω	220 Ω	390 Ω	390 Ω
$I_{D(on)}$	-15 mA	-7 mA	-3 mA	-1 mA

*Non-inductive

INPUT PULSE

Rise Time < 1 ns
 Fall Time < 1 ns
 Pulse Width 100 ns
 PRF 1 MHz

SAMPLING SCOPE

Rise Time 0.4 ns
 Input Resistance 10 M Ω
 Input Capacitance 1.5 pF

See Typical Characteristics curves for changes.

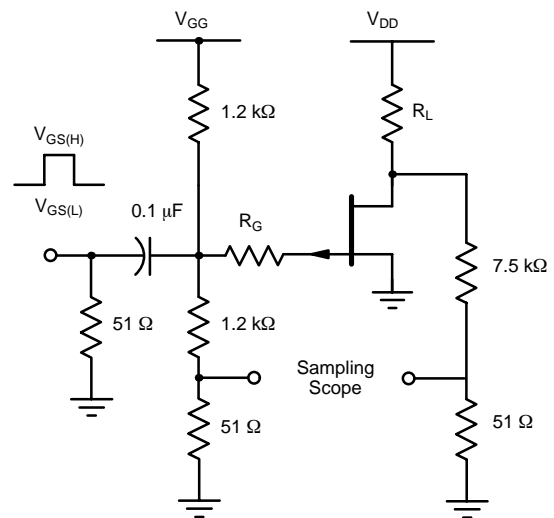



Disclaimer

All product specifications and data are subject to change without notice.

Vishay Intertechnology, Inc., its affiliates, agents, and employees, and all persons acting on its or their behalf (collectively, "Vishay"), disclaim any and all liability for any errors, inaccuracies or incompleteness contained herein or in any other disclosure relating to any product.

Vishay disclaims any and all liability arising out of the use or application of any product described herein or of any information provided herein to the maximum extent permitted by law. The product specifications do not expand or otherwise modify Vishay's terms and conditions of purchase, including but not limited to the warranty expressed therein, which apply to these products.

No license, express or implied, by estoppel or otherwise, to any intellectual property rights is granted by this document or by any conduct of Vishay.

The products shown herein are not designed for use in medical, life-saving, or life-sustaining applications unless otherwise expressly indicated. Customers using or selling Vishay products not expressly indicated for use in such applications do so entirely at their own risk and agree to fully indemnify Vishay for any damages arising or resulting from such use or sale. Please contact authorized Vishay personnel to obtain written terms and conditions regarding products designed for such applications.

Product names and markings noted herein may be trademarks of their respective owners.