

## 86016-5 Product Details

---

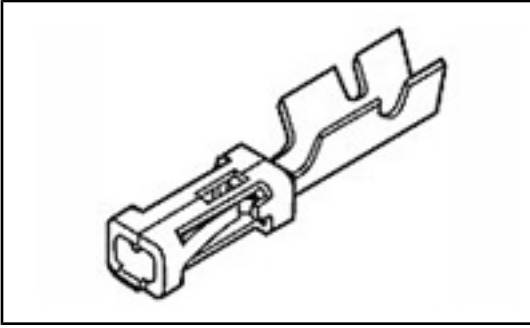

**86016-5**

TE Internal Number: 86016-5

 [Active](#)

### .100 AMPMODU Headers, Housings & Contacts

 [Always EU RoHS/ELV Compliant \(Statement of Compliance\)](#)

#### Product Highlights:

- Contact
- Contact Type = Receptacle
- Terminate To Wire
- Wire Insulation Diameter = 1.75 mm
- Wire Range = 0.20-0.60<sup>2</sup> [24-20] mm [AWG]

[View all Features](#)

## Documentation & Additional Information

### Product Drawings:

- [RECEPTACLE CONTACT, MOD IV](#) (PDF, English)

### Catalog Pages/Data Sheets:

- [AMPMODU INTERCONNECTION SYSTEM SECTION5 CONT](#) (PDF, English)

### Product Specifications:

- [PRODUCT SPECIFICATION INTERCONNECTION SYSTEM, AMPMOD...](#) (PDF, English)

### Application Specifications:

- [AMPMODU MOD IV, IV1/2, and V Receptacles and Housings](#) (PDF, English)

### Instruction Sheets:

- None Available

### CAD Files: ([CAD Format & Compression Information](#))

- [2D Drawing](#) (DXF, Version B)
- [3D Model](#) (IGES, Version B)
- [3D Model](#) (STEP, Version B)

[List all Documents](#)

### Additional Information:

- [Product Line Information](#)

### Related Products:

- [Tooling](#)

## Product Features (Please use the Product Drawing for all design activity)

### Product Type Features:

- Product Type = Contact
- Wire Insulation Diameter (mm [in]) = 1.75 [0.069]
- [Connector Series](#) = Mod IV
- Wire Termination Type = Crimp
- With Insulation Support = Yes
- Applied Pressure = Standard
- Comment = (\*) For use with Model "K" machines. Call the Technical Assistance Center (1-800-522-6752) for part numbers of applicators for use with Model "G" machines, as well as other bench machines and fully automatic AMPOMATOR lead making machines.

### Electrical Characteristics:

- Voltage Rating (VAC) = 250
- Contact Current Rating (Amps.) = 3
- Termination Resistance (m  $\Omega$ ) = 12
- Insulation Resistance (M  $\Omega$ ) = 5,000
- Dielectric Withstanding Voltage (V) = 750

### Termination Related Features:

- Crimp Area Plating = Gold Flash

### Contact Related Features:

- Contact Type = Receptacle
- [Contact Mating Area Plating Material](#) = Gold (15)
- Contact Base Material = Beryllium Copper
- Approved Standards = UL E28476, CSA LR7189

### Industry Standards:

- [RoHS/ELV Compliance](#) = RoHS compliant, ELV compliant
- [Lead Free Solder Processes](#) = Not relevant for lead free process
- RoHS/ELV Compliance History = Always was RoHS compliant

### Conditions for Usage:

- [Terminate To](#) = Wire
- Operating Temperature ( $^{\circ}$ C) = -65 – +105

### Packaging Related Features:

- Packaging Method = Loose Piece

### Other:

- Brand = AMP

**Body Related Features:**

- [Wire Range \(mm \[AWG\]\)](#) = 0.20-0.60<sup>2</sup> [24-20]