

KA5S-SERIES

KA5S0765C/KA5S0965/KA5S12656/KA5S1265

Fairchild Power Switch(FPS)

Features

- Wide Operating Frequency Range Up to 150kHz
- Lowest Cost SMPS Solution
- Lowest External Components
- Low Start-up Current (Max:170 μ A)
- Low Operating Current (Max:12mA)
- Internal High Voltage SenseFET
- Over Voltage Protection With Latch Mode (Min23V)
- Over Load Protection With Latch Mode
- Over Current Protection With Latch Mode
- Internal Thermal Protection With Latch Mode
- Pulse By Pulse Over Current Limiting
- Under Voltage Lockout With Hysteresis
- External Sync. Terminal

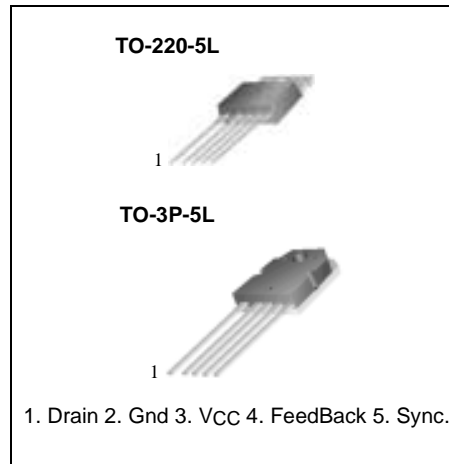

Internal Block Diagram

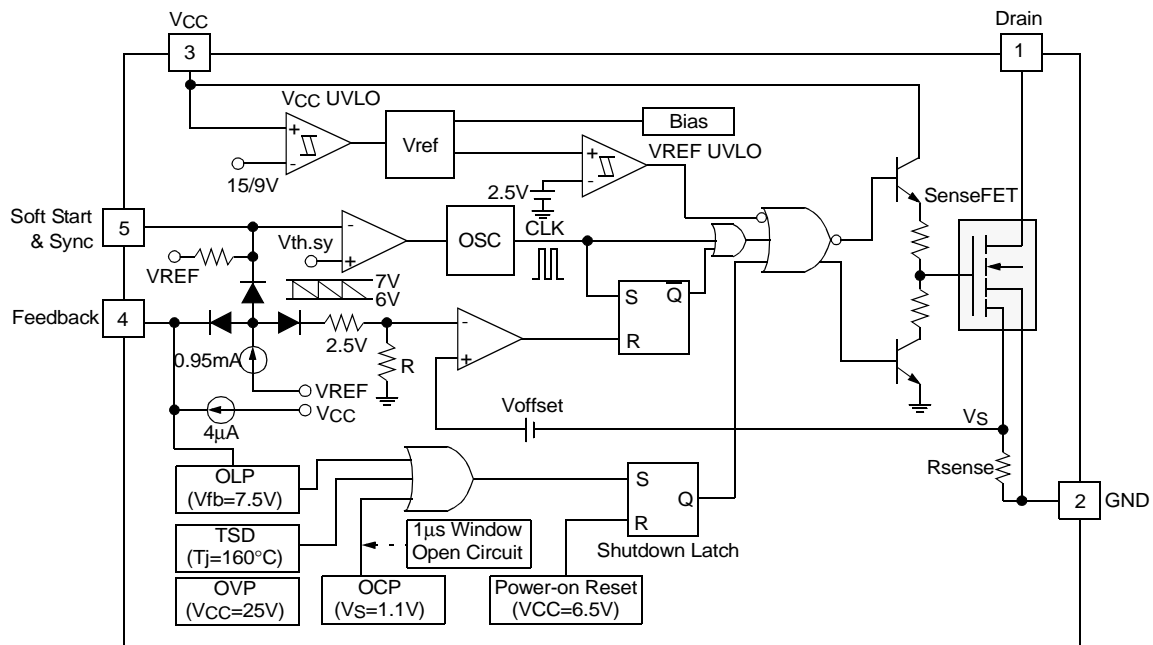

Rev.1.0.5

Absolute Maximum Ratings

(Ta=25°C, unless otherwise specified)

Characteristic	Symbol	Value	Unit
KA5S0765C			
Drain-Gate Voltage(RGS=1MΩ)	VDGR	650	V
Gate-Source(GND) Voltage	VGS	±30	V
Drain Current Pulsed ⁽¹⁾	IDM	28	ADC
Continuous Drain Current (Tc = 25°C)	ID	7.0	ADC
Continuous Drain Current (Tc = 100°C)	ID	5.6	ADC
Single Pulsed Avalanch Current ⁽³⁾ (Energy ⁽²⁾)	IAS(EAS)	27(570)	A(mJ)
Maximum Supply Voltage	VCC,MAX	30	V
Input Voltage Range	VFB	-0.3 to VCC	V
	VSS	-0.3 to 8	V
Total Power Dissipation	PD (Watt H/S)	140	W
	Darting	1.11	W/°C
Operating Junction Temperature.	TJ	+160	°C
Operating Ambient Temperature.	TA	-25 to +85	°C
Storage Temperature Range.	TSTG	-55 to +150	°C
KA5S0965			
Drain-Gate Voltage(RGS=1MΩ)	VDGR	650	V
Gate-Source(GND) Voltage	VGS	±30	V
Drain Current Pulsed ⁽¹⁾	IDM	36	ADC
Continuous Drain Current (Tc = 25°C)	ID	9.0	ADC
Continuous Drain Current (Tc = 100°C)	ID	5.8	ADC
Single Pulsed Avalanch Current ⁽³⁾ (Energy ⁽²⁾)	IAS(EAS)	25(950)	A(mJ)
Maximum Supply Voltage	VCC,MAX	30	V
Input Voltage Range	VFB	-0.3 to VCC	V
	VSS	-0.3 to 8	V
Total Power Dissipation	PD (Watt H/S)	170	W
	Darting	1.33	W/°C
Operating Junction Temperature.	TJ	+160	°C
Operating Ambient Temperature.	TA	-25 to +85	°C
Storage Temperature Range.	TSTG	-55 to +150	°C

Absolute Maximum Ratings (Continued)

(Ta=25°C, unless otherwise specified)

Characteristic	Symbol	Value	Unit
KA5S12656			
Drain-Gate Voltage(RGS=1MΩ)	VDGR	650	V
Gate-Source(GND) Voltage	VGS	±30	V
Drain Current Pulsed ⁽¹⁾	IDM	48	ADC
Continuous Drain Current (Tc = 25°C)	ID	12	ADC
Continuous Drain Current (Tc = 100°C)	ID	8.4	ADC
Single Pulsed Avalanch Current ⁽³⁾ (Energy ⁽²⁾)	IAS(EAS)	25(785)	A(mJ)
Maximum Supply Voltage	VCC,MAX	30	V
Input Voltage Range	VFB	-0.3 to VCC	V
	VSS	-0.3 to 8	V
Total Power Dissipation	PD (Watt H/S)	160	W
	Darting	1.28	W/°C
Operating Junction Temperature.	TJ	+160	°C
Operating Ambient Temperature.	TA	-25 to +85	°C
Storage Temperature Range.	TSTG	-55 to +150	°C
KA5S1265			
Drain-Gate Voltage(RGS=1MΩ)	VDGR	650	V
Gate-Source(GND) Voltage	VGS	±30	V
Drain Current Pulsed ⁽¹⁾	IDM	48	ADC
Continuous Drain Current (Tc = 25°C)	ID	12	ADC
Continuous Drain Current (Tc = 100°C)	ID	8.4	ADC
Single Pulsed Avalanch Current ⁽³⁾ (Energy ⁽²⁾)	IAS(EAS)	42(785)	A(mJ)
Maximum Supply Voltage	VCC,MAX	30	V
Input Voltage Range	VFB	-0.3 to VCC	V
	VSS	-0.3 to 8	V
Total Power Dissipation	PD (Watt H/S)	160	W
	Darting	1.28	W/°C
Operating Junction Temperature.	TJ	+160	°C
Operating Ambient Temperature.	TA	-25 to +85	°C
Storage Temperature Range.	TSTG	-55 to +150	°C

Note:

1. Repetitive rating : Pulse width limited by maximum junction temperature
2. L = 10mH, VDD =50V, RG = 27Ω, starting Tj = 25°C
3. L = 13μH, starting Tj = 25°C

Electrical Characteristics (SFET Part)

(Ta = 25°C unless otherwise specified)

Parameter	Symbol	Conditions	Min.	Typ.	Max.	Unit
KA5S0765C						
Drain-Source Breakdown Voltage	BVDSS	VGS=0V, ID=50μA	650	-	-	V
Zero Gate Voltage Drain Current	IDSS	VDS=Max., Rating, VGS=0V	-	-	50	μA
		VDS=0.8Max., Rating, VGS=0V, TC=125°C	-	-	200	μA
Static Drain-Source on Resistance ⁽¹⁾	RDS(on)	VGS=10V, ID=4.0A	-	1.25	1.6	Ω
Forward Transconductance ⁽¹⁾	gfs	VDS=15V, ID=4.0A	3.0	-	-	S
Input Capacitance	Ciss	VGS=0V, VDS=25V, f = 1MHz	-	1600	-	pF
Output Capacitance	Coss		-	310	-	
Reverse Transfer Capacitance	Crss		-	120	-	
Turn on Delay Time	td(on)	VDD=0.5B VDSS, ID=7.0A (MOSFET switching time is essentially independent of operating temperature)	-	25	-	nS
Rise Time	tr		-	55	-	
Turn Off Delay Time	td(off)		-	80	-	
Fall Time	tf		-	50	-	
Total Gate Charge (Gate-Source+Gate-Drain)	Qg	VGS=10V, ID=7.0A, VDS=0.5B VDSS(MOSFET switching time is essentially independent of operating temperature)	-	-	72	nC
Gate-Source Charge	Qgs		-	9.3	-	
Gate-Drain (Miller) Charge	Qgd		-	29.3	-	
KA5S0965						
Drain-Source Breakdown Voltage	BVDSS	VGS=0V, ID=50μA	650	-	-	V
Zero Gate Voltage Drain Current	IDSS	VDS=Max., Rating, VGS=0V	-	-	50	μA
		VDS=0.8Max., Rating, VGS=0V, TC=125°C	-	-	200	μA
Static Drain-Source on Resistance ⁽¹⁾	RDS(on)	VGS=10V, ID=4.5A	-	0.96	1.2	Ω
Forward Transconductance ⁽¹⁾	gfs	VDS=50V, ID=4.5A	5.0	-	-	S
Input Capacitance	Ciss	VGS=0V, VDS=25V, f = 1MHz	-	1750	-	pF
Output Capacitance	Coss		-	190	-	
Reverse Transfer Capacitance	Crss		-	78	-	
Turn on Delay Time	td(on)	VDD=0.5B VDSS, ID=9.0A (MOSFET switching time is essentially independent of operating temperature)	-	20	50	nS
Rise Time	tr		-	23	55	
Turn Off Delay Time	td(off)		-	85	180	
Fall Time	tf		-	30	70	
Total Gate Charge (Gate-Source+Gate-Drain)	Qg	VGS=10V, ID=9.0A, VDS=0.5B VDSS(MOSFET switching time is essentially independent of operating temperature)	-	74	95	nC
Gate-Source Charge	Qgs		-	12	-	
Gate-Drain (Miller) Charge	Qgd		-	35	-	

Electrical Characteristics (SFET Part) (Continued)

(Ta = 25°C unless otherwise specified)

Parameter	Symbol	Conditions	Min.	Typ.	Max.	Unit
KA5S12656						
Drain-Source Breakdown Voltage	BVDSS	VGS=0V, ID=50μA	650	-	-	V
Zero Gate Voltage Drain Current	IDSS	VDS=Max., Rating, VGS=0V	-	-	50	μA
		VDS=0.8Max., Rating, VGS=0V, TC=125°C	-	-	200	μA
Static Drain-Source On Resistance ⁽¹⁾	RDS(on)	VGS=10V, ID=6.0A	-	0.72	0.9	Ω
Forward Transconductance ⁽¹⁾	gfs	VDS=50V, ID=4.0A	5.7	-	-	S
Input Capacitance	Ciss	VGS=0V, VDS=25V, f = 1MHz	-	2700	-	pF
Output Capacitance	Coss		-	300	-	
Reverse Transfer Capacitance	Crss		-	61	-	
Turn on Delay Time	td(on)	VDD=0.5B VDS, ID=12.0A (MOSFET switching time is essentially independent of operating temperature)	-	18	-	nS
Rise Time	tr		-	37	-	
Turn Off Delay Time	td(off)		-	88	-	
Fall Time	tf		-	36	-	
Total Gate Charge (Gate-Source+Gate-Drain)	Qg	VGS=10V, ID=12.0A, VDS=0.5B VDS(MOSFET switching time is essentially independent of operating temperature)	-	-	140	nC
Gate-Source Charge	Qgs		-	20	-	
Gate-Drain (Miller) Charge	Qgd		-	69	-	
KA5S1265						
Drain-Source Breakdown Voltage	BVDSS	VGS=0V, ID=50μA	650	-	-	V
Zero Gate Voltage Drain Current	IDSS	VDS=Max., Rating, VGS=0V	-	-	50	μA
		VDS=0.8Max., Rating, VGS=0V, TC=125°C	-	-	200	μA
Static Drain-Source on Resistance ⁽¹⁾	RDS(on)	VGS=10V, ID=6.0A	-	0.72	0.9	Ω
Forward Transconductance ⁽¹⁾	gfs	VDS=50V, ID=4.0A	5.7	-	-	S
Input Capacitance	Ciss	VGS=0V, VDS=25V, f = 1MHz	-	2700	-	pF
Output Capacitance	Coss		-	300	-	
Reverse Transfer Capacitance	Crss		-	61	-	
Turn on Delay Time	td(on)	VDD=0.5BVDSS, ID=12.0A (MOSFET switching time is essentially independent of operating temperature)	-	18	-	nS
Rise Time	tr		-	37	-	
Turn Off Delay Time	td(off)		-	88	-	
Fall Time	tf		-	36	-	
Total Gate Charge (Gate-Source+Gate-Drain)	Qg	VGS=10V, ID=12.0A, VDS=0.5B VDS(MOSFET switching time is essentially independent of operating temperature)	-	-	140	nC
Gate-Source Charge	Qgs		-	20	-	
Gate-Drain (Miller) Charge	Qgd		-	69	-	

Note:

1. Pulse Test : Pulse width ≤ 300μs, Duty Cycle ≤ 2%
2. MOSFET switching time is essentially independent of operating temperature

$$3. S = \frac{1}{R}$$

Electrical Characteristics (Control Part) (Continued)(V_{CC}=16V, T_{amb} = 25°C unless otherwise specified)

Parameter	Symbol	Conditions	Min.	Typ.	Max.	Unit
UVLO SECTION						
Start Threshold Voltage	V _{START}	V _{FB} =GND	14	15	16	V
Stop Threshold Voltage	V _{STOP}	V _{FB} =GND	8	9	10	V
OSCILLATOR SECTION						
Initial Frequency	F _{OSC}	-	18	20	22	kHz
Voltage Stability	F _{STABLE}	12V ≤ V _{CC} ≤ 23V	0	1	3	%
Temperature Stability (Note2)	ΔF _{OSC}	-25°C ≤ T _a ≤ 85°C	0	±5	±10	%
Maximum Duty Cycle	D _{MAX}	-	92	95	98	%
Minimum Duty Cycle	D _{MIN}	-	-	-	0	%
FEEDBACK SECTION						
Feedback Source Current	I _{FB}	V _{FB} =GND	0.7	0.9	1.1	mA
Shutdown Feedback Voltage	V _{SD}	V _{FB} ≥ 6.9V	6.9	7.5	8.1	V
Shutdown Delay Current	I _{DELAY}	V _{FB} =5V	3.0	4.0	5.0	μA
SYNC. & SOFTSTART SECTION						
Softstart Voltage	V _{SS}	V _{FB} =2V	4.7	5.0	5.3	V
Softstart Current	I _{SS}	V _{SS} =0V	0.75	0.95	1.15	mA
Sync High Threshold Voltage(Note3)	V _{SYNCH}	V _{CC} =16V, V _{FB} =5V	-	7.0	-	V
Sync Low Threshold Voltage(Note3)	V _{SYNCL}	V _{CC} =16V, V _{FB} =5V	-	6.0	-	V
CURRENT LIMIT(SELF-PROTECTION)SECTION						
Peak Current Limit (Note4)	I _{OVER}	KA5S0765C	3.52	4.0	4.48	A
		KA5S0965	5.28	6.0	6.72	
		KA5S12656	5.28	6.0	6.72	
		KA5S1265	7.04	8.0	8.96	
PROTECTION SECTION						
Over Voltage Protection	V _{OVP}	V _{CC} ≥ 24V	23	25	28	V
Over Current Latch voltage(Note3)	V _{OCL}	-	0.9	1.0	1.1	V
Thermal Shutdown Temperature(Note2)	T _{SD}	-	140	160	-	°C
TOTAL DEVICE SECTION						
Start Up Current	I _{START}	V _{FB} =GND, V _{CC} =14V	-	0.1	0.17	mA
Operating Supply Current(Note1)	I _{OP}	V _{FB} =GND, V _{CC} =16V	-	7	12	mA
	I _{OP(MIN)}	V _{FB} =GND, V _{CC} =12V				
	I _{OP(MAX)}	V _{FB} =GND, V _{CC} =30V				

Note:

1. These parameters are the current flowing in the control IC.
2. These parameters, although guaranteed, are not 100% tested in mass production
3. These parameters, although guaranteed, are tested in EDS(wafer test) process
4. These parameters are indicated Inductor current.

Typical Performance Characteristics

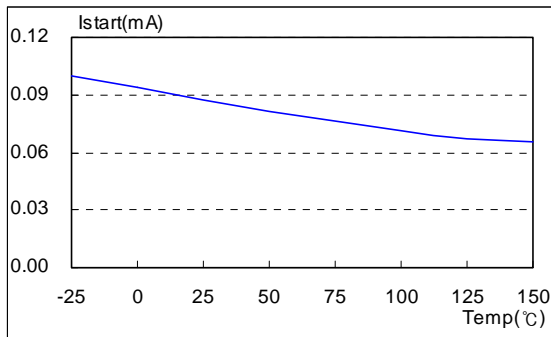

Figure 1. Start Up Current vs. Temp.

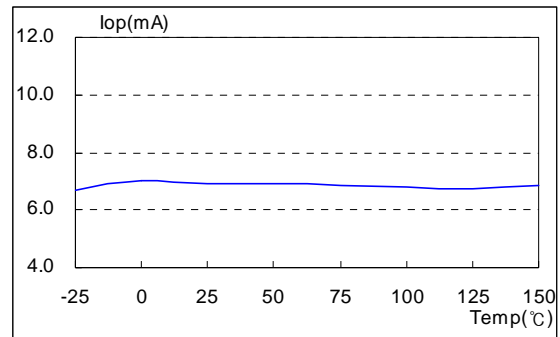

Figure 2. Operating Supply Current vs. Temp.

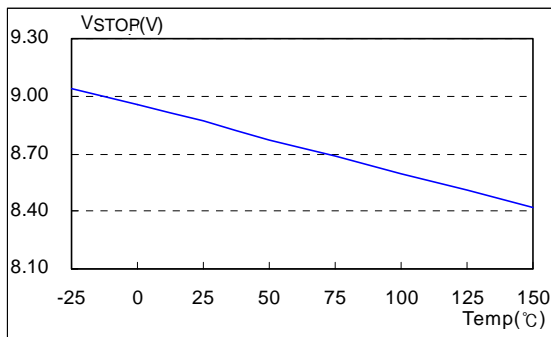

Figure 3. Stop Threshold Voltage vs. Temp

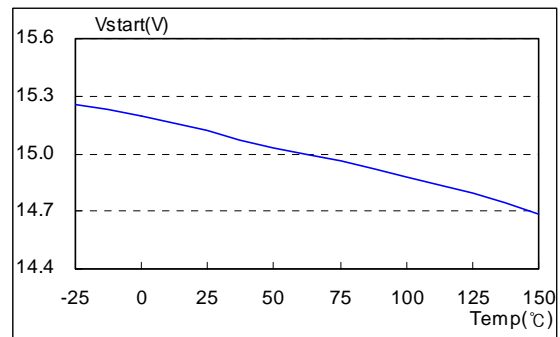

Figure 4. Start Threshold Voltage vs. Temp

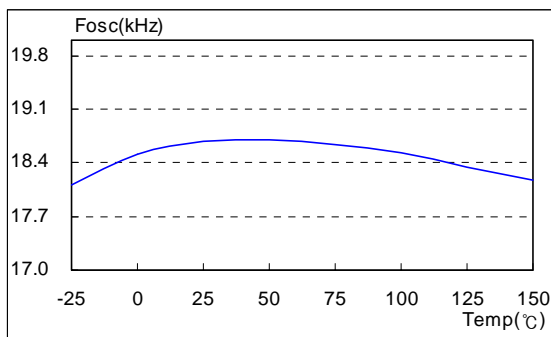

Figure 5. Initial Frequency VS. Temp

Typical Performance Characteristics (Continued)

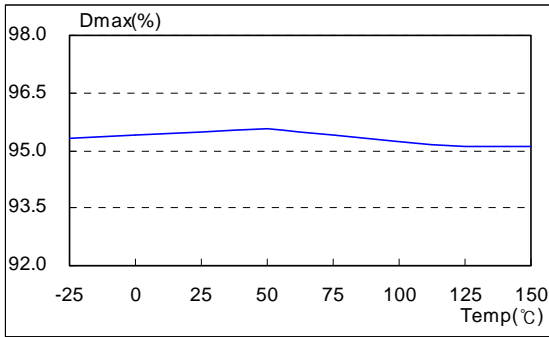

Figure 6. Maximum Duty vs. Temp.

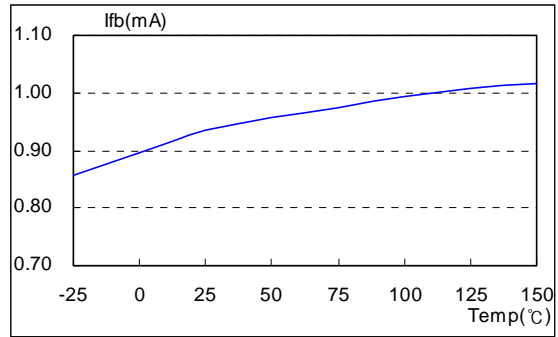

Figure 7. Feedback Source Current vs. Temp.

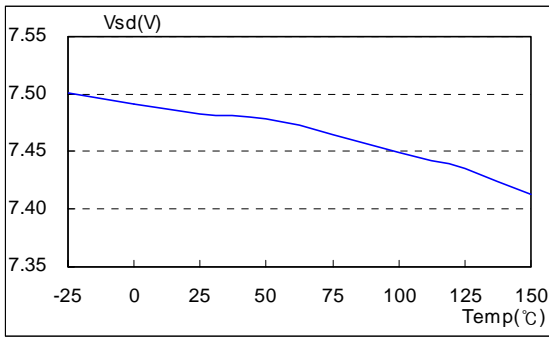

Figure 8. Shutdown Feedback Voltage vs. Temp.

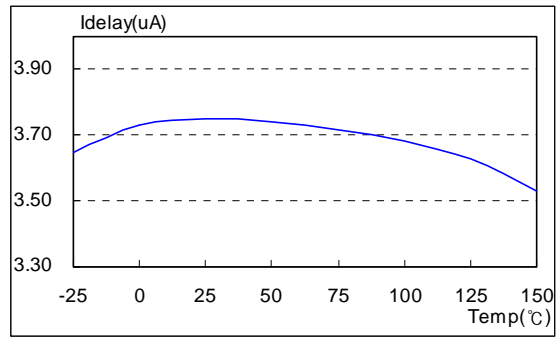

Figure 9. Shutdown Delay Current vs. Temp.

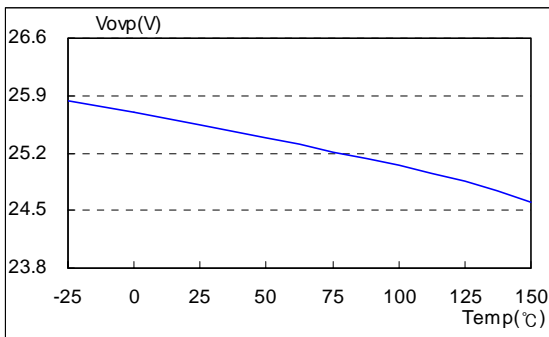

Figure 10. Over Voltage Protection vs. Temp.

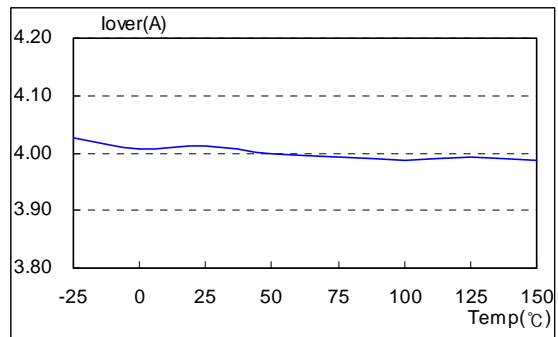
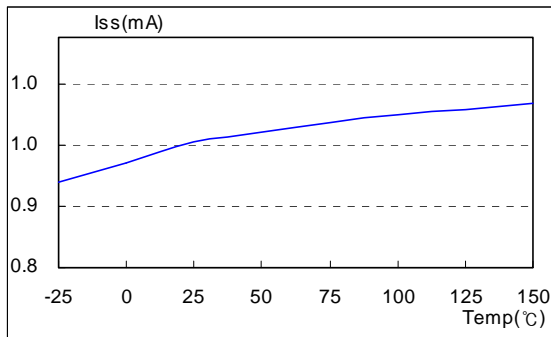
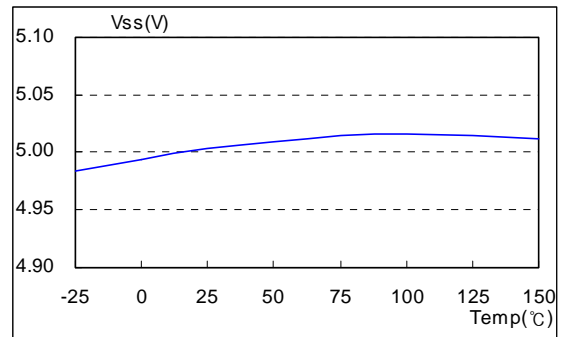
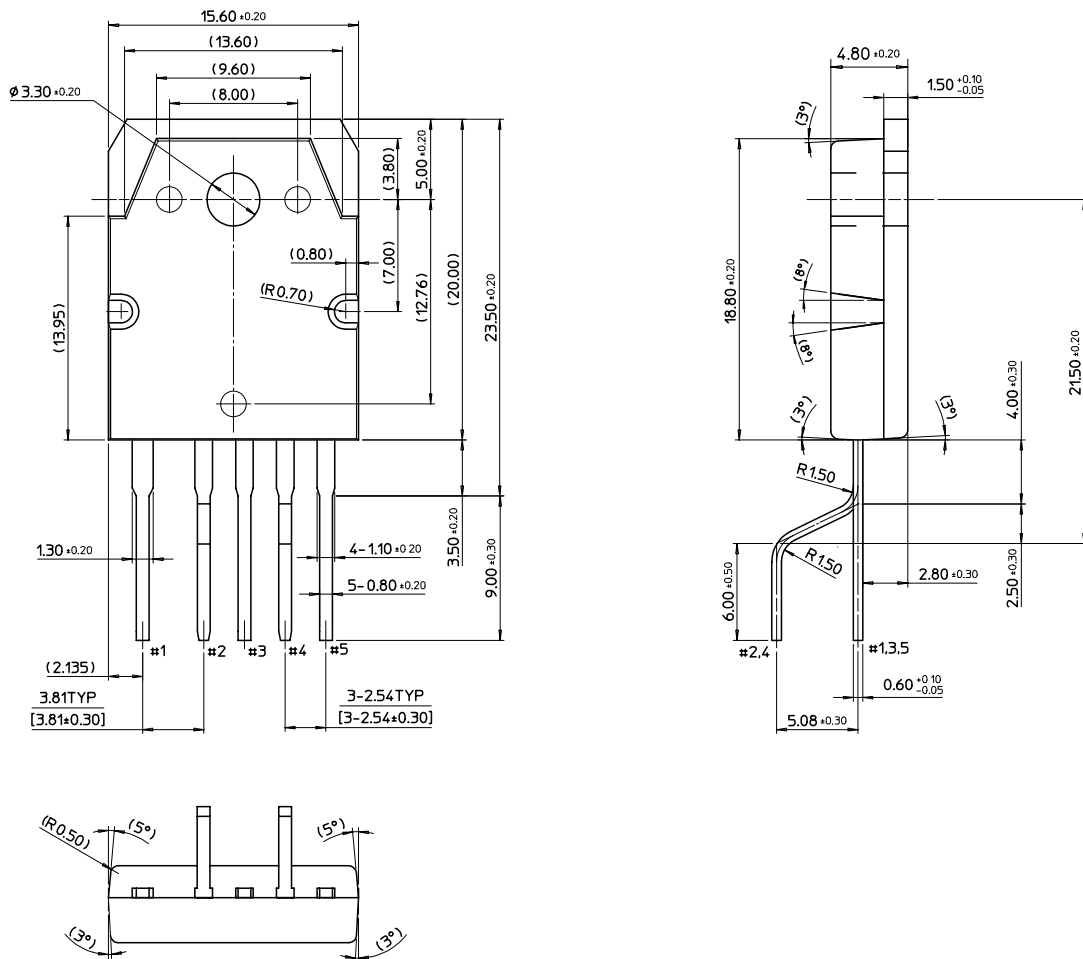

Figure 11. Peak Current Limit vs. Temp

Typical Performance Characteristics (Continued)**Figure 12. Soft Start Current vs. Temp.****Figure 13. Soft Start Voltage vs. Temp.**

Package Dimensions (Continued)

TO-3P-5L(Forming)



Package Dimensions (Continued)

TO-220-5L

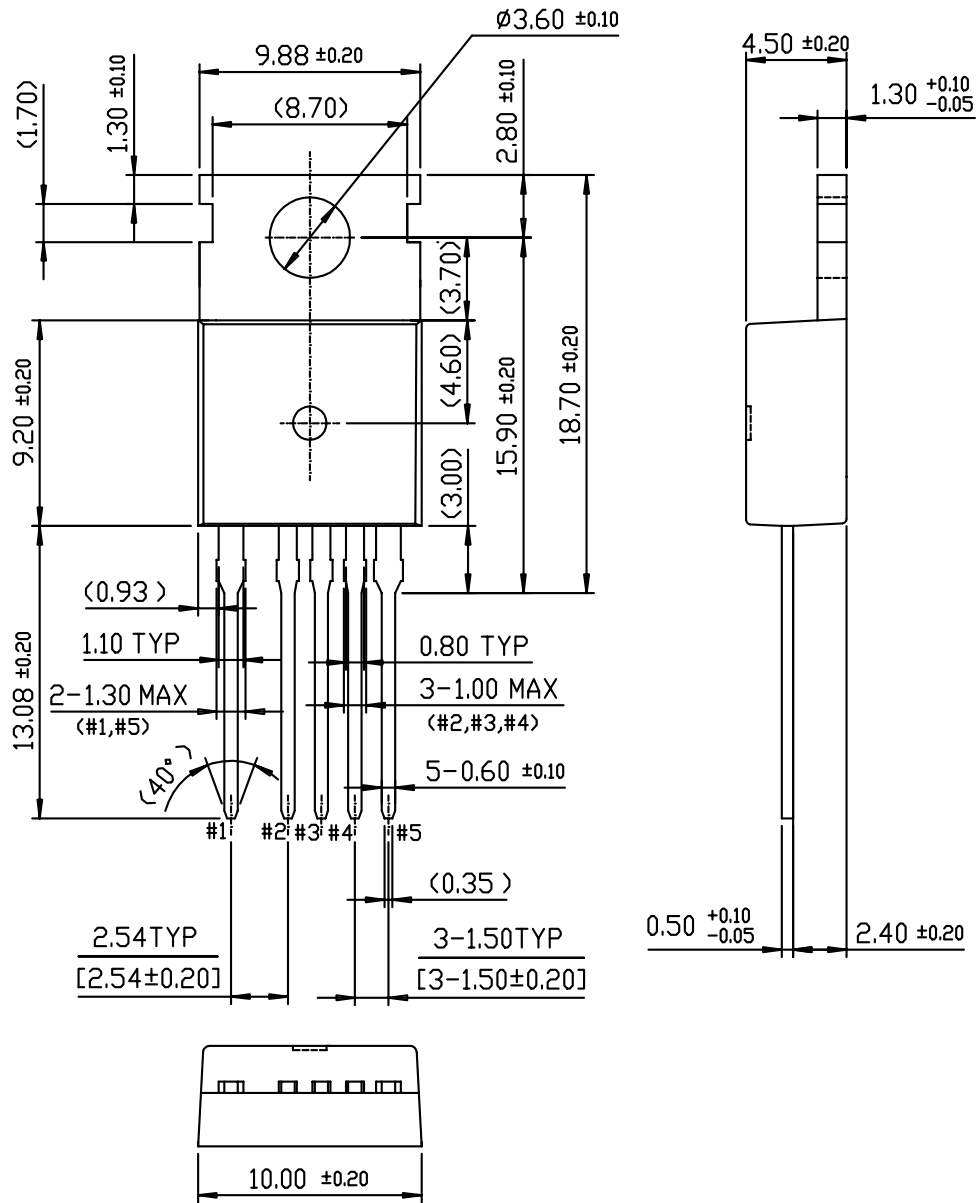

Package Dimensions (Continued)

TO-220-5L(Forming)

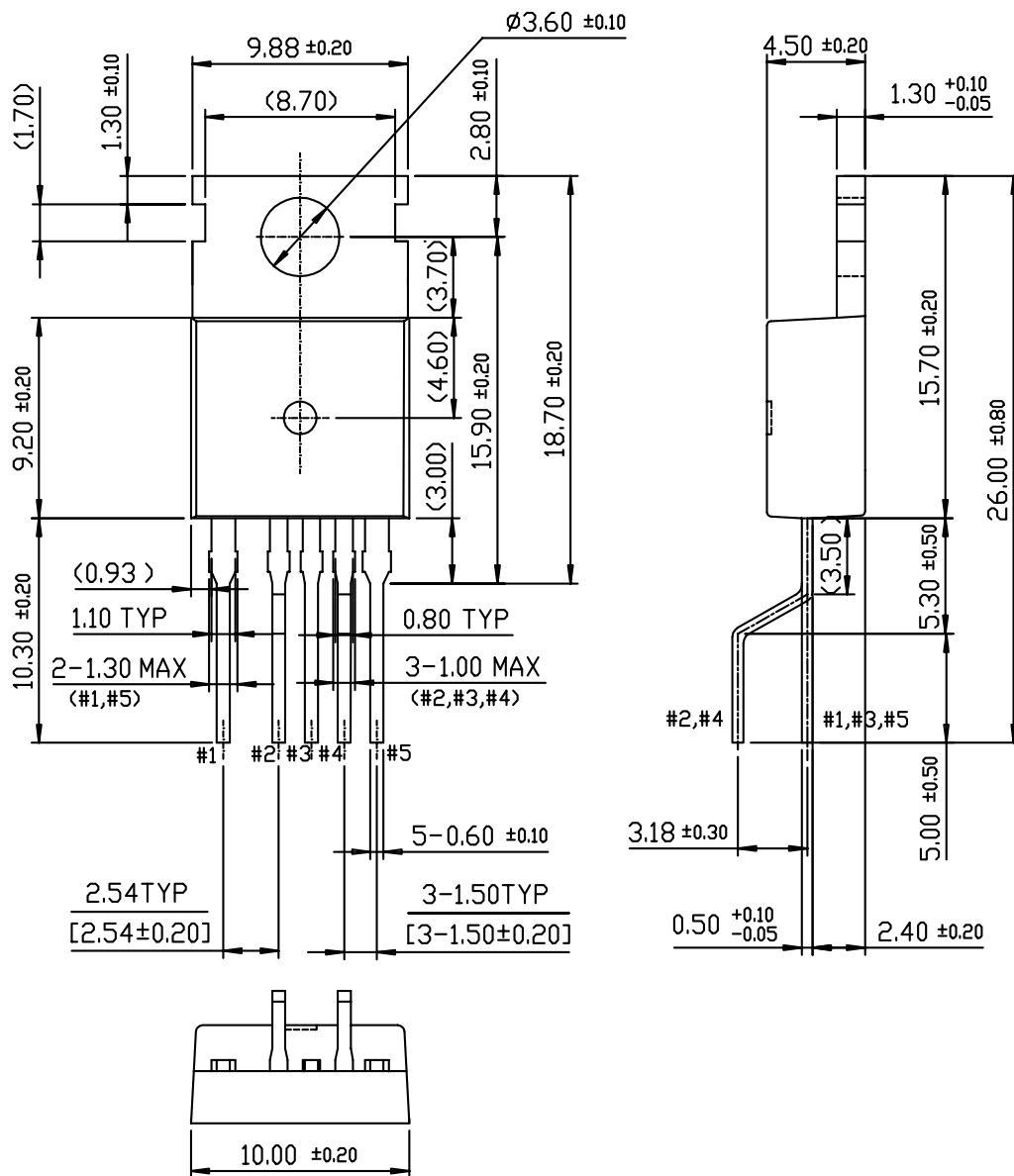

TOP Mark and Pinout Information

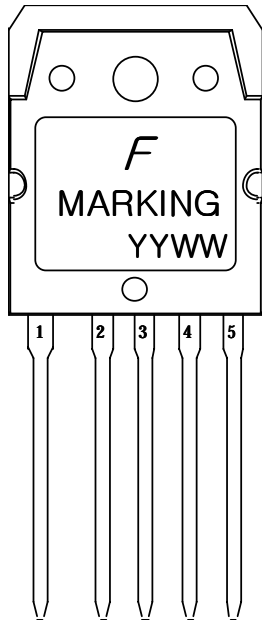

Pin No.	Symbol	Description
1	Drain	SenseFET Drain
2	GND	Ground (Source)
3	VCC	Control Part Supply Input
4	F/B	PWM Non Inverting Input
5	S/S	Soft start & External Sync.

Device	Marking
KA5S0765C	5S0765C
KA5S0965	5S0965
KA5S12656	5S12656
KA5S1265	5S1265

Notes ;

- (1) F ; Fairchild Semiconductor
- (2) 5S0765C, 5S0965, 5S12656, 5S1265; Device Marking Name
- (3) YY: Last Two Digit of Calender Year
- (4) WW: Patweek Based on Fairchild Semiconductor Work Month Calender

Ordering Information

Product Number	Package	Marking Code	BVdss	Rds(on)
KA5S0765CTU	TO-220-5L	5S0765C	650V	1.6Ω
KA5S0765CYDTU	TO-220-5L(Forming)			
KA5S0965TU	TO-3P-5L	5S0965	650V	1.2Ω
KA5S0965YDTU	TO-3P-5L(Forming)			
KA5S12656TU	TO-3P-5L	5S12656	650V	0.9Ω
KA5S12656YDTU	TO-3P-5L(Forming)			
KA5S1265TU	TO-3P-5L	5S1265	650V	0.9Ω
KA5S1265YDTU	TO-3P-5L(Forming)			

TU : Non Forming Type

YDTU : Forming Type

DISCLAIMER

FAIRCHILD SEMICONDUCTOR RESERVES THE RIGHT TO MAKE CHANGES WITHOUT FURTHER NOTICE TO ANY PRODUCTS HEREIN TO IMPROVE RELIABILITY, FUNCTION OR DESIGN. FAIRCHILD DOES NOT ASSUME ANY LIABILITY ARISING OUT OF THE APPLICATION OR USE OF ANY PRODUCT OR CIRCUIT DESCRIBED HEREIN; NEITHER DOES IT CONVEY ANY LICENSE UNDER ITS PATENT RIGHTS, NOR THE RIGHTS OF OTHERS.

LIFE SUPPORT POLICY

FAIRCHILD'S PRODUCTS ARE NOT AUTHORIZED FOR USE AS CRITICAL COMPONENTS IN LIFE SUPPORT DEVICES OR SYSTEMS WITHOUT THE EXPRESS WRITTEN APPROVAL OF THE PRESIDENT OF FAIRCHILD SEMICONDUCTOR CORPORATION. As used herein:

1. Life support devices or systems are devices or systems which, (a) are intended for surgical implant into the body, or (b) support or sustain life, and (c) whose failure to perform when properly used in accordance with instructions for use provided in the labeling, can be reasonably expected to result in a significant injury of the user.
2. A critical component in any component of a life support device or system whose failure to perform can be reasonably expected to cause the failure of the life support device or system, or to affect its safety or effectiveness.