

Chip Multilayer Delay Lines



Chip Multilayer Delay Lines

This Delay Line was developed by applying ceramic multilayering and hole technology. It consists of copper line and low dielectric constant material and incorporates metal shields. LDH series are very small and made for use at high frequencies.

■ Features

1. High stability at high frequency (2GHz)
2. Small, thin and light, utilizing multilayer construction
3. Metal shield is built inside chip.
4. Reflow solderable
5. Supplied on tape



LDH31 Series

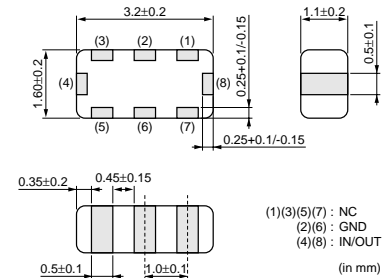

Terminal of "NC" should not be fixed to any pattern.
All the technical data and information contained herein are subject to change without prior notice.



LDH32 Series

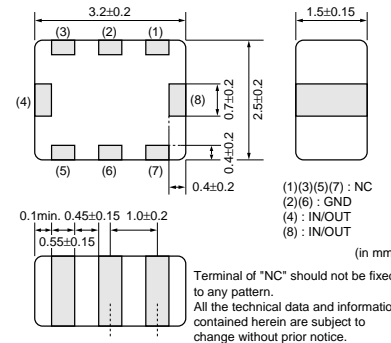

Terminal of "NC" should not be fixed to any pattern.
All the technical data and information contained herein are subject to change without prior notice.



LDH43 Series

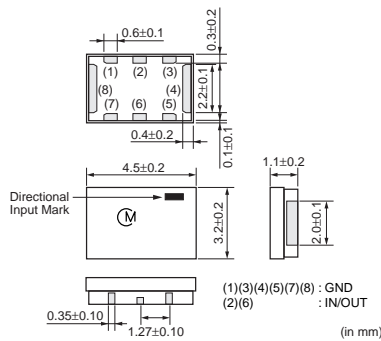

All the technical data and information contained herein are subject to change without prior notice.



LDH54 Series

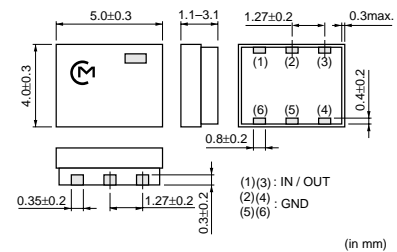

LDH65 Series

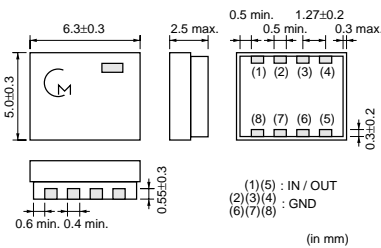

LDHA2 Series

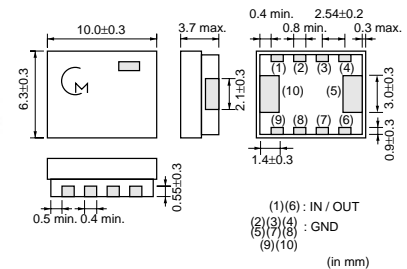

| Part Number | Delay Time (ns) | Impedance (ohm) | Rising Time (ns) | Insulation Resistance (M ohm) | Rated Current (mA) |
|------------------|-----------------------------|---------------------------|------------------|-------------------------------|--------------------|
| LDH311N00LAC-810 | 0.1 ±15% | 50 (Nominal) | 0.8 max. | 100 min. | 50 |
| LDH311N50LAC-810 | 1.5 ±15% | 50 (Nominal) | 1.0 max. | 100 min. | 50 |
| LDH312N00LAC-810 | 2.0 ±15% | 50 (Nominal) | 1.5 max. | 100 min. | 50 |
| LDH321N00LAC-800 | 1.0 ±15% | 50 (Nominal) | 0.8 max. | 100 min. | 50 |
| LDH321N50LAC-800 | 1.5 ±15% | 50 (Nominal) | 1.0 max. | 100 min. | 50 |
| LDH322N00LAC-800 | 2.0 ±15% | 50 (Nominal) | 1.5 max. | 100 min. | 50 |
| LDH322N50LAC-800 | 2.5 ±15% | 50 (Nominal) | 1.8 max. | 100 min. | 50 |
| LDH323N00LAC-800 | 3.0 ±15% | 50 (Nominal) | 2.0 max. | 100 min. | 50 |
| LDH43050PAAA-830 | 50.0 ns±11.0ns (at 10.0GHz) | 50 (at 10.0GHz) (Nominal) | - | 100 min. | 50 |
| LDH43060PAAA-830 | 60.0 ps±11.0ps (at 10.0GHz) | 50 (at 10.0GHz) (Nominal) | - | 100 min. | 50 |
| LDH43070PAAA-830 | 70.0 ps±11.0ps (at 10.0GHz) | 50 (at 10.0GHz) (Nominal) | - | 100 min. | 50 |
| LDH43080PAAA-830 | 80.0 ps±11.0ps (at 10.0GHz) | 50 (at 10.0GHz) (Nominal) | - | 100 min. | 50 |
| LDH43090PAAA-830 | 90.0 ps±11.0ps (at 10.0GHz) | 50 (at 10.0GHz) (Nominal) | - | 100 min. | 50 |
| LDH43100PAAA-830 | 100.0 ps±11.0% (at 10.0GHz) | 50 (at 10.0GHz) (Nominal) | - | 100 min. | 50 |
| LDH43110PKAA-830 | 110.0 ps±11.0% (at 10.0GHz) | 50 (at 10.0GHz) (Nominal) | - | 100 min. | 50 |
| LDH43120PKAA-830 | 120.0 ps±11.0% (at 10.0GHz) | 50 (at 10.0GHz) (Nominal) | - | 100 min. | 50 |
| LDH43130PKAA-830 | 130.0 ps±11.0% (at 10.0GHz) | 50 (at 10.0GHz) (Nominal) | - | 100 min. | 50 |
| LDH43140PKAA-830 | 140.0 ps±11.0% (at 10.0GHz) | 50 (at 10.0GHz) (Nominal) | - | 100 min. | 50 |
| LDH43150PKAA-830 | 150.0 ps±11.0% (at 10.0GHz) | 50 (at 10.0GHz) (Nominal) | - | 100 min. | 50 |
| LDH54100PAAA-600 | 0.1 ±0.05ns | 50 ±7 (at 100MHz) | 0.15 max. | 100 min. | 50 |
| LDH54200PAAA-600 | 0.2 ±0.05ns | 50 ±7 (at 100MHz) | 0.15 max. | 100 min. | 50 |
| LDH54300PAAA-600 | 0.3 ±0.05ns | 50 ±7 (at 100MHz) | 0.15 max. | 100 min. | 50 |
| LDH54400PAAA-600 | 0.4 ±0.05ns | 50 ±7 (at 100MHz) | 0.15 max. | 100 min. | 50 |
| LDH54500PAAA-600 | 0.5 ±0.05ns | 50 ±7 (at 100MHz) | 0.15 max. | 100 min. | 50 |
| LDH54600PBAA-600 | 0.6 ±0.1ns | 50 ±7 (at 100MHz) | 0.3 max. | 100 min. | 50 |
| LDH54700PBAA-600 | 0.7 ±0.1ns | 50 ±7 (at 100MHz) | 0.3 max. | 100 min. | 50 |
| LDH54800PBAA-600 | 0.8 ±0.1ns | 50 ±7 (at 100MHz) | 0.3 max. | 100 min. | 50 |
| LDH54900PBAA-600 | 0.9 ±0.1ns | 50 ±7 (at 100MHz) | 0.3 max. | 100 min. | 50 |
| LDH541N00BAA-600 | 1.0 ±0.1ns | 50 ±7 (at 100MHz) | 0.3 max. | 100 min. | 50 |
| LDH541N50BAA-600 | 1.5 ±0.1ns | 50 ±7 (at 100MHz) | 0.5 max. | 100 min. | 50 |
| LDH542N00BAA-600 | 2.0 ±0.1ns | 50 ±7 (at 100MHz) | 0.5 max. | 100 min. | 50 |
| LDH542N50BAA-600 | 2.5 ±0.1ns | 50 ±7 (at 100MHz) | 0.5 max. | 100 min. | 50 |
| LDH543N00KAB-700 | 3.0 ±0.3ns | 75 (Nominal) | 2.0 max. | 100 min. | 50 |
| LDH544N00KAB-700 | 4.0 ±0.4ns | 75 (Nominal) | 2.5 max. | 100 min. | 50 |
| LDH545N00KAB-700 | 5.0 ±0.5ns | 75 (Nominal) | 2.5 max. | 100 min. | 50 |
| LDH546N00KAB-700 | 6.0 ±0.6ns | 75 (Nominal) | 3.0 max. | 100 min. | 50 |
| LDH547N00KAB-700 | 7.0 ±0.7ns | 75 (Nominal) | 3.5 max. | 100 min. | 50 |
| LDH548N00KAB-700 | 8.0 ±0.8ns | 75 (Nominal) | 3.5 max. | 100 min. | 50 |
| LDH549N00KAB-700 | 9.0 ±0.9ns | 75 (Nominal) | 4.0 max. | 100 min. | 50 |
| LDH5410N0KAB-700 | 10.0 ±1.0ns | 75 (Nominal) | 4.5 max. | 100 min. | 50 |
| LDH65100PAAA-400 | 0.1 ±0.05ns | 50 ±5 (at 100MHz) | 0.10 max. | 100 min. | 100 |
| LDH65200PAAA-400 | 0.2 ±0.05ns | 50 ±5 (at 100MHz) | 0.10 max. | 100 min. | 100 |
| LDH65300PAAA-400 | 0.3 ±0.05ns | 50 ±5 (at 100MHz) | 0.15 max. | 100 min. | 100 |
| LDH65400PAAA-400 | 0.4 ±0.05ns | 50 ±5 (at 100MHz) | 0.15 max. | 100 min. | 100 |
| LDH65500PAAA-400 | 0.5 ±0.05ns | 50 ±5 (at 100MHz) | 0.15 max. | 100 min. | 100 |
| LDH65600PBAA-400 | 0.6 ±0.1ns | 50 ±5 (at 100MHz) | 0.15 max. | 100 min. | 100 |
| LDH65700PBAA-400 | 0.7 ±0.1ns | 50 ±5 (at 100MHz) | 0.20 max. | 100 min. | 100 |
| LDH65800PBAA-400 | 0.8 ±0.1ns | 50 ±5 (at 100MHz) | 0.20 max. | 100 min. | 100 |
| LDH65900PBAA-400 | 0.9 ±0.1ns | 50 ±5 (at 100MHz) | 0.20 max. | 100 min. | 100 |
| LDH651N00BAA-400 | 1.0 ±0.1ns | 50 ±5 (at 100MHz) | 0.20 max. | 100 min. | 100 |
| LDHA2500PAAA-300 | 0.5 ±0.05ns | 50 ±5 (at 100MHz) | 0.15 max. | 100 min. | 100 |
| LDHA21N00BAA-300 | 1.0 ±0.1ns | 50 ±5 (at 100MHz) | 0.20 max. | 100 min. | 100 |
| LDHA21N50BAA-300 | 1.5 ±0.1ns | 50 ±5 (at 100MHz) | 0.30 max. | 100 min. | 100 |
| LDHA22N00BAA-300 | 2.0 ±0.1ns | 50 ±5 (at 100MHz) | 0.40 max. | 100 min. | 100 |
| LDHA22N50BAA-300 | 2.5 ±0.1ns | 50 ±5 (at 100MHz) | 0.40 max. | 100 min. | 100 |
| LDHA23N00BAA-300 | 3.0 ±0.1ns | 50 ±10 (at 100MHz) | 0.75 max. | 100 min. | 100 |
| LDHA24N00BAA-300 | 4.0 ±0.1ns | 50 ±10 (at 100MHz) | 1.00 max. | 100 min. | 100 |

Continued on the following page. 

Continued from the preceding page.

| Part Number | Delay Time (ns) | Impedance (ohm) | Rising Time (ns) | Insulation Resistance (M ohm) | Rated Current (mA) |
|------------------|-----------------|--------------------|------------------|-------------------------------|--------------------|
| LDHA25N00BAA-300 | 5.0 ±0.1ns | 50 ±10 (at 100MHz) | 1.25 max. | 100 min. | 100 |
| LDHA26N00CAA-300 | 6.0 ±0.2ns | 50 ±10 (at 100MHz) | 1.50 max. | 100 min. | 100 |
| LDHA27N00CAA-300 | 7.0 ±0.2ns | 50 ±10 (at 100MHz) | 1.75 max. | 100 min. | 100 |
| LDHA28N00CAA-300 | 8.0 ±0.2ns | 50 ±10 (at 100MHz) | 2.00 max. | 100 min. | 100 |
| LDHA29N00CAA-300 | 9.0 ±0.2ns | 50 ±10 (at 100MHz) | 2.25 max. | 100 min. | 100 |
| LDHA210N0CAA-300 | 10.0 ±0.2ns | 50 ±10 (at 100MHz) | 2.50 max. | 100 min. | 100 |

Operating Temperature Range : -40°C to +85°C

Group Delay Time

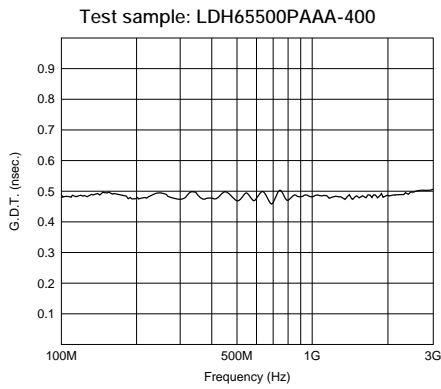

Pulse Response

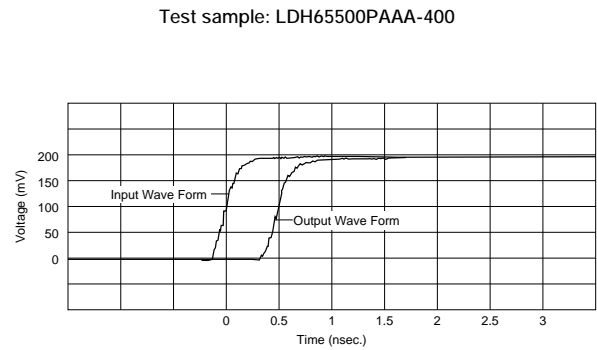

Impedance

Test sample: LDH65500PAAA-400
Frequency Range : 100MHz to 3GHz (Smith Chart)

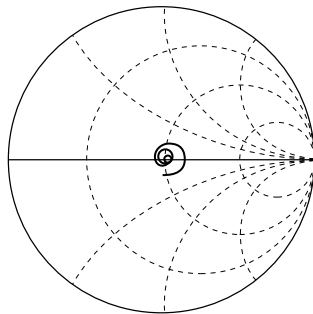

Return Loss

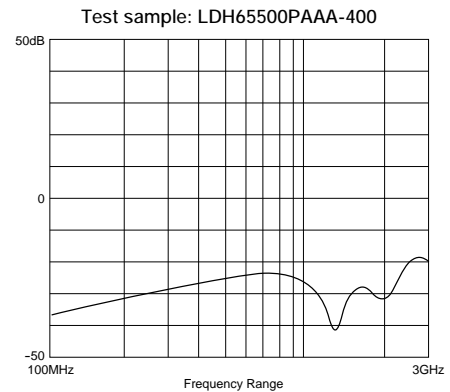

Insertion Loss

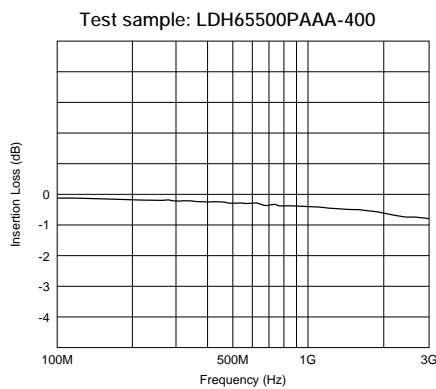

Soldering and Mounting

Standard Land Dimensions

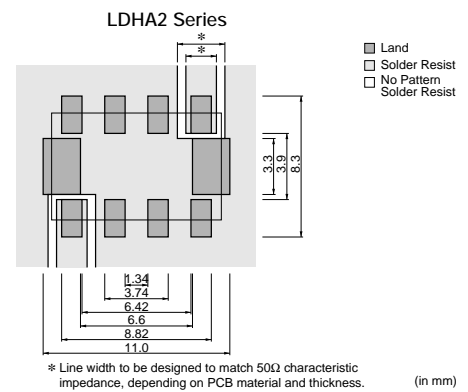
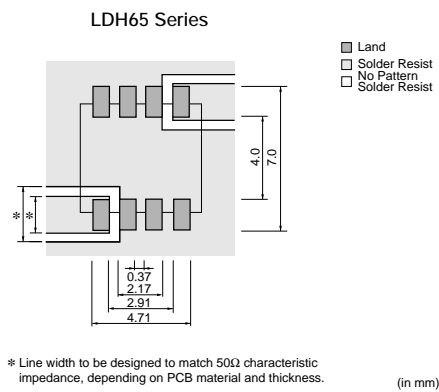
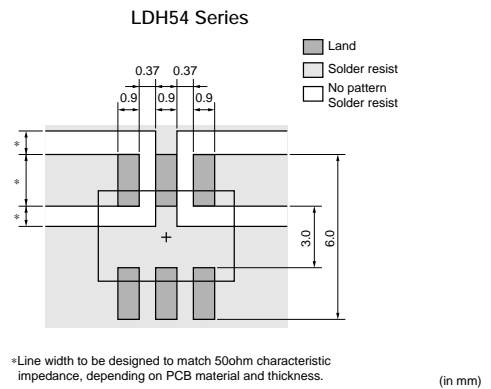
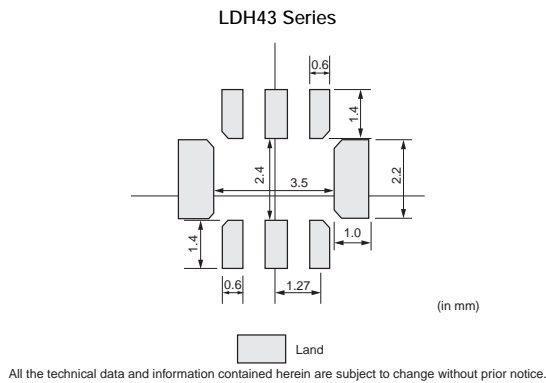
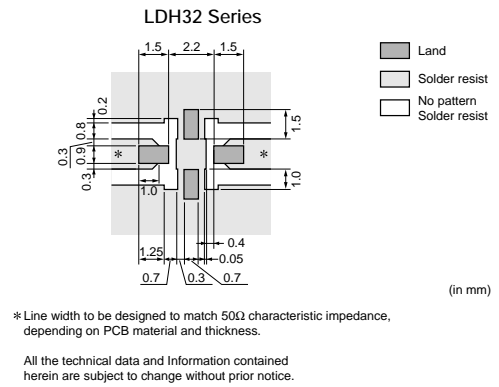
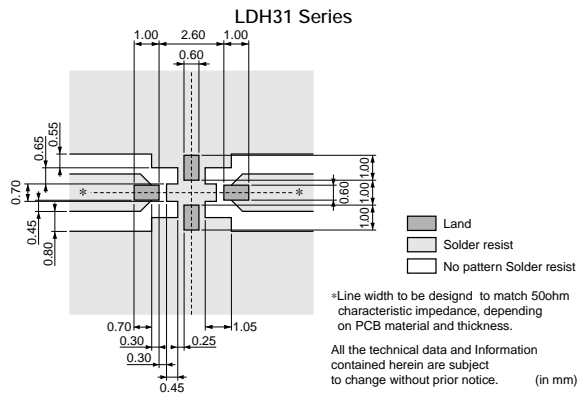

Packaging

Minimum Quantity

| Part Number | Dimensions (mm) | | | Minimum Quantity | |
|-------------|-----------------|-----|---------|------------------|-------------|
| | L | W | T | Ø180mm Reel | Ø330mm Reel |
| LDH31 | 3.2 | 1.6 | 1.1 | 3000 | |
| LDH32 | 3.2 | 2.5 | 1.5 | 2000 | |
| LDH43 | 4.5 | 3.2 | 1.1 | 1000 | |
| LDH54 | 5.0 | 4.0 | 1.1-3.1 | 1000 * | |
| LDH65 | 6.3 | 5.0 | 2.5 | 500 | |
| LDHA2 | 10.0 | 6.3 | 3.7 | | 500 |

* 500pcs. for LDH542N0 and LDH542N5.

Dimensions of Taping

LDH31 Series

● Plastic Tape

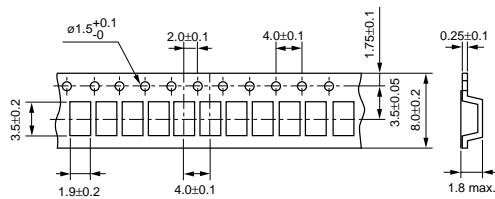

● Reel

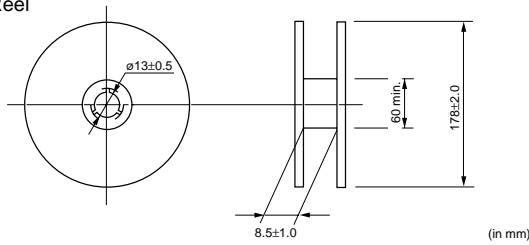

LDH32 Series

● Plastic Tape

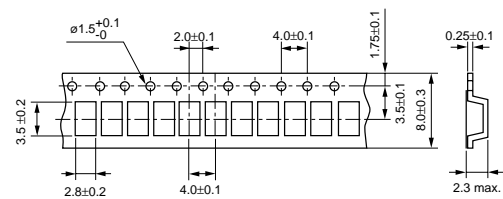

● Reel

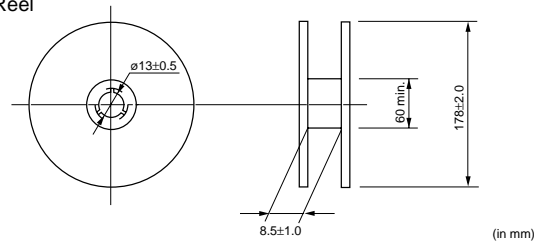

LDH43 Series

● Plastic Tape

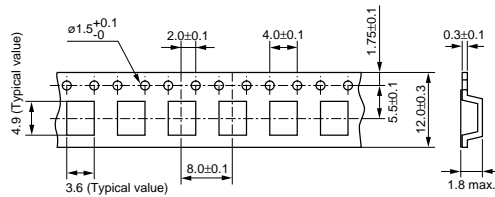

● Reel

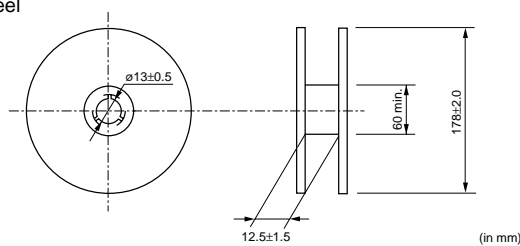

LDH54 Series

● Plastic Tape

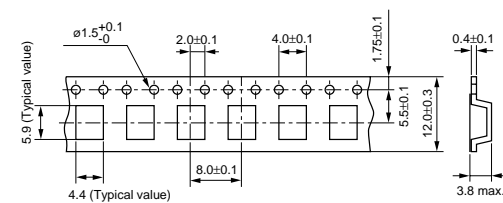

● Reel

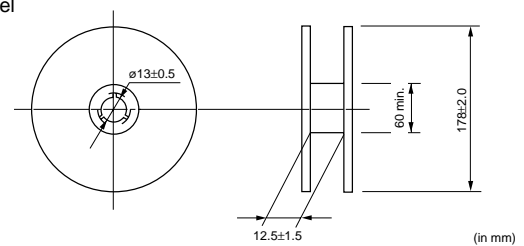

Continued on the following page.

Packaging

Continued from the preceding page.

Dimensions of Taping

LDH65 Series

● Plastic Tape

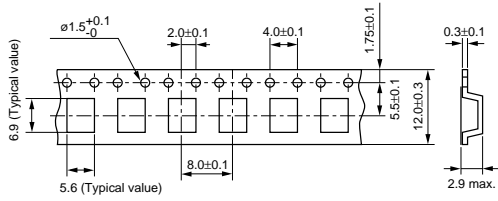

● Reel

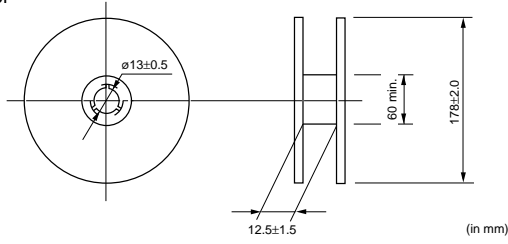

LDHA2 Series

● Plastic Tape

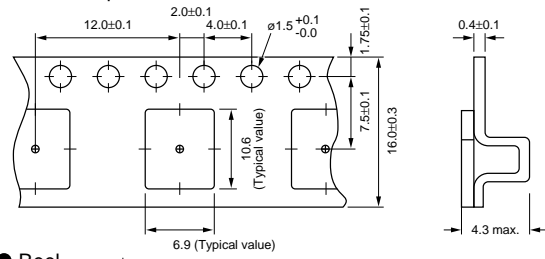

● Reel

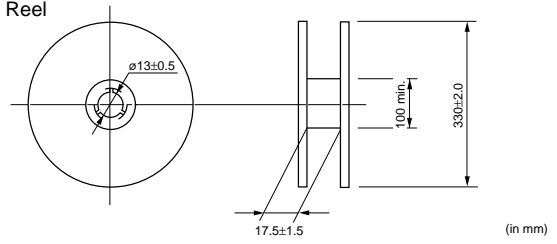

Notice

■ Notice (Storage and Operating Condition)

To avoid damaging the solderability of the external electrodes, be sure to observe the following points.

- Store products where the ambient temperature is 15 to 35°C and the relative humidity is 45 to 75% RH. (Packing materials, in particular, may be deformed at temperatures over 40°C.)
- Bulk packed chip components should be used as soon as the seal is opened, thus preventing the solderability from deteriorating. The remaining unused components should be put in the original bag and resealed, or stored in a desiccator containing a desiccating agent.
- Store products in non-corrosive gas (Cl₂, NH₃, SO₂, Nox, etc.).
- Stored products should be used within 6 months of receipt. Solderability should be verified if this period is exceeded.

■ Notice (Rating)

Products should be used in an input power capacity as specified in this catalog.

Consult with Murata beforehand if a different input power capacity range is required.

Notice

■ Notice (Soldering and Mounting)

1. Standard PCB Design (Land Pattern and Dimensions):

All the ground terminals should be connected to the ground patterns. Please refer to specifications for standard land dimensions.

The recommended land pattern and dimensions is as Murata's standard. The characteristics of products may vary depending on the pattern drawing method, grounding method, land dimensions and the PCB material and thickness. Therefore, be sure to verify the characteristics in the actual set. When using non-standard lands, contact Murata beforehand.

2. Soldering Conditions:

Carefully perform preheating so that the temperature difference (ΔT) between the solder and products surface should be in the following range. When products are immersed in solvent after mounting, pay special attention to maintain the temperature difference within 100°C. Soldering must be carried out by the above mentioned conditions to prevent products from damage. If other soldering conditions exist, please contact Murata before use.

| Soldering method | Temperature |
|-----------------------|-----------------------------------|
| Soldering iron method | $\Delta T \leq 130^\circ\text{C}$ |
| Reflow method | |

● Soldering iron method conditions are indicated below.

| Item | Kind of iron | |
|-------------------------|--------------------------|--------------------------|
| | Nichrome heater | Ceramics heater |
| Soldering iron wattage | $\leq 30\text{W}$ | $\leq 18\text{W}$ |
| Temperature of iron-tip | $\leq 280^\circ\text{C}$ | $\leq 250^\circ\text{C}$ |

■ Notice (Handling)

- Be careful in handling or transporting products because excessive stress or mechanical shock may break products due to the nature of ceramics structure.
- Handle with care. If products are cracked or have damaged terminals, their characteristics may change.
Do not touch products with bare hands. Poor solderability may result.

- Diameter of iron-tip : f3.0 mm max.

- Do not allow the iron-tip to directly touch the ceramic element.

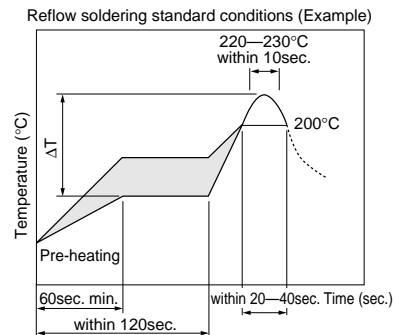

Use rosin type flux or weakly active flux with a chlorine content of 0.2 wt % or less.

Use eutectic crystal solder.

Amount of Solder Paste:

- Ensure that solder is applied smoothly to a minimum height of 0.2 to 0.5 mm at the end surface of the external electrodes. If too much or little solder is applied, there is high possibility that the mechanical strength will be insufficient, creating the variation of characteristics.

3. Notice for Chip Placement

When the products are placed on the PCB, they may be stressed and broken by uneven forces from a wornout chucking locator claw or suction device. To prevent damage to products, be sure to follow the maintenance specifications for the chip placer. Be aware that mechanical chucking may damage products when positioning them on the PCB.

Notice

■ Notice (Other)

1. Cleaning Conditions:

The total cleaning time of soaking, ultrasonic and steam methods should be within 5 minutes.

Consult with Murata concerning the cleaning solvent. In order to totally abolish ODC (Freon, Trichloroethane), Murata has carried out testing on non-cleaning and water-cleaning solvents (water-soluble flux, water-soluble cream solder, water-based cleaning solvent). Therefore, be sure to contact Murata beforehand for details when applying any of the above mentioned cleaning fluids.

The ultrasonic cleaning conditions are indicated below :

| | |
|-------------|---------------------|
| Power | 20 W per liter max. |
| Frequency | 50 - 60 kHz |
| Temperature | 40 deg.C max. |

If the ultrasonic output power is too high, the PCB may resonate and products mounted on the PCB may be damaged. The ultrasonic cleaning conditions may change depending on the size of the vessel and the size of the PCB. Contact Murata regarding conditions other than those stated above.

Be sure to completely dry products immediately after cleaning.

2. Operational Environment Conditions:

Products are designed to work for electronic products under normal environmental conditions (ambient temperature, humidity and pressure). However, if products are used under the following circumstances, it may damage products and leakage of electricity and abnormal temperature may occur.

- In an atmosphere containing corrosive gas (Cl₂, NH₃, SO_x, NO_x etc.)
- In an atmosphere containing combustible and volatile gases
- Dusty conditions
- Direct sunlight
- Wet conditions
- High humidity locations
- Freezing conditions

If products could be used under the preceding conditions, consult with Murata before actual use. Be sure to completely dry products immediately after cleaning.

● Part Numbering

Chip Multilayer Delay Lines

(Part Number)

| | | | | | | | |
|----|---|----|------|---|---|---|------|
| LD | H | 65 | 100P | A | A | A | -400 |
| ① | ② | ③ | ④ | ⑤ | ⑥ | ⑦ | ⑧ |

① Product ID

| Product ID | |
|------------|-------------------------|
| LD | Chip Multilayer Devices |

② Function

| Code | Function |
|----------|-------------|
| H | Delay Lines |

③ Dimension (L×W)

| Code | Dimension (L×W) | EIA |
|-----------|-----------------|------|
| 21 | 2.00×1.25mm | 0805 |
| 31 | 3.20×1.60mm | 1206 |
| 32 | 3.20×2.50mm | 1210 |
| 43 | 4.50×3.20mm | - |
| 54 | 5.00×4.00mm | - |
| 65 | 6.30×5.00mm | - |
| A2 | 10.0×6.3mm | - |

④ Delay Time

Three figures and a capital letter express the nominal value. If the unit is "nano-second", a decimal point is expressed by the capital letter "N". If the unit is "pico-second", the letter "P".

⑤ Delay Time Tolerance

| Code | Delay Time Tolerance |
|----------|----------------------|
| A | ±0.05ns |
| B | ±0.1ns |
| C | ±0.2ns |
| K | ±10% |
| L | ±15% |

⑥ Individual Specification Code (1)

| Code | Individual Specification Code (1) |
|----------|-----------------------------------|
| A | Standard |

⑦ Design

| Code | Design |
|----------|---|
| A | A letter expresses identification of design type for each function. |

⑧ Individual Specification Code (2)

A hyphen (-), figures or letters express the specifications of other characteristics.

⚠Note:

1. Export Control

〈For customers outside Japan〉

No muRata products should be used or sold, through any channels, for use in the design, development, production, utilization, maintenance or operation of, or otherwise contribution to (1) any weapons (Weapons of Mass Destruction (nuclear, chemical or biological weapons or missiles) or conventional weapons) or (2) goods or systems specially designed or intended for military end-use or utilization by military end-users.

〈For customers in Japan〉

For products which are controlled items subject to the "Foreign Exchange and Foreign Trade Law" of Japan, the export license specified by the law is required for export.

2. Please contact our sales representatives or product engineers before using the products in this catalog for the applications listed below, which require especially high reliability for the prevention of defects which might directly damage a third party's life, body or property, or when one of our products is intended for use in applications other than those specified in this catalog.

- | | |
|-----------------------------|--|
| ① Aircraft equipment | ② Aerospace equipment |
| ③ Undersea equipment | ④ Power plant equipment |
| ⑤ Medical equipment | ⑥ Transportation equipment (vehicles, trains, ships, etc.) |
| ⑦ Traffic signal equipment | ⑧ Disaster prevention / crime prevention equipment |
| ⑨ Data-processing equipment | ⑩ Application of similar complexity and/or reliability requirements to the applications listed above |

3. Product specifications in this catalog are as of September 2002. They are subject to change or our products in it may be discontinued without advance notice. Please check with our sales representatives or product engineers before ordering. If there are any questions, please contact our sales representatives or product engineers.

4. Please read rating and ⚠CAUTION (for storage, operating, rating, soldering, mounting and handling) in this catalog to prevent smoking and/or burning, etc.

5. This catalog has only typical specifications because there is no space for detailed specifications. Therefore, please approve our product specifications or transact the approval sheet for product specifications before ordering.

6. Please note that unless otherwise specified, we shall assume no responsibility whatsoever for any conflict or dispute that may occur in connection with the effect of our and/or a third party's intellectual property rights and other related rights in consideration of your use of our products and/or information described or contained in our catalogs. In this connection, no representation shall be made to the effect that any third parties are authorized to use the rights mentioned above under licenses without our consent.

7. No ozone depleting substances (ODS) under the Montreal Protocol are used in our manufacturing process.



Murata Manufacturing Co., Ltd.

<http://www.murata.com/>

Head Office
1-10-1, Higashi Kotari, Nagaokakyo-shi, Kyoto 617-8555, Japan
Phone: 81-75-951-9111

International Division
3-29-12, Shibuya, Shibuya-ku, Tokyo 150-0002, Japan
Phone: 81-3-5469-6123 Fax: 81-3-5469-6155 E-mail: intl@murata.co.jp