

Weld-Spatter Resistant DC 2-Wire Cylindrical Sensors

- Rugged fluoroplastic coated brass barrel withstands high tightening torque
- Fluoroplastic resin face prevents weld slag build up on sensor
- Stability and operation indicators standard
- Prewired and pigtail connector models



Ordering Information

■ PREWIRED MODELS

Sensing head		Sensing distance	Output configuration	Part number
M12	Shielded 	3 mm (0.12 in)	NO	E2EQ-X3D1
M18		7 mm (0.28 in)		E2EQ-X7D1
M30		10 mm (0.39 in)		E2EQ-X10D1

■ PIGTAIL CONNECTOR SENSORS

Sensing head		Sensing distance	Output configuration	Part number
M12	Shielded 	3 mm (0.12 in)	NO	E2EQ-X3D1-M1GJ
M18		7 mm (0.28 in)		E2EQ-X7D1-M1GJ
M30		10 mm (0.39 in)		E2EQ-X10D1-M1GJ

■ CONNECTOR CORDSETS

			Part number	
Connector type	Cable size	Length	Straight connector	Right angle connector
3-wire DC	22 AWG	2 m (6.5 ft)	Y96E-435D2	Y96E-43RD2
Micro change®		5 m (16.4 ft)	Y96E-435D5	Y96E-43RD5
		10 m (32.8 ft)	Y96E-435D10	Y96E-43RD10

Specifications

■ RATINGS/CHARACTERISTICS

Part number		E2EQ-X3D1 E2EQ-X3D1-M1GJ	E2EQ-X7D1 E2EQ-X7D1-M1GJ	E2EQ-X10D1 E2EQ-X10D1-M1GJ
Sensor type		Inductive		
Body	Size	M12	M18	M30
	Type	Shielded		
Supply voltage (operating voltage range)		12 to 24 VDC (10 to 30 VDC)		
Leakage current		0.8 mA max.		
Detectable object type		Magnetic metals (refer to <i>Engineering Data</i> for non-magnetic metals)		
Sensing distance		3 mm ±10% (0.12 in)	7 mm ±10% (0.28 in)	10 mm ±10% (0.39 in)
Sensing distance (standard object)		0 to 2.4 mm (0.09 in) (Iron, 12 x 12 x 1 mm)	0 to 5.6 mm (0.22 in) (Iron, 18 x 18 x 1 mm)	0 to 8.0 mm (0.31 in) (Iron, 30 x 30 x 1 mm)
Differential travel		10% max. of sensing distance		
Control output (switching capacity)		3 to 100 mA		
Operation (with sensing object approaching)		Load ON		
Residual voltage		3.0 V max. under load current of 100 mA with cable length of 2 m		
Temperature influence		±10% max. of sensing distance at 23°C in the temperature range of -25°C and 70°C		
Voltage influence		±2.5% max. of sensing distance within a range of ±15% of the rated voltage		
Response frequency (See Note.)		1.0 kHz	0.5 kHz	0.4 kHz
Circuit protection		Reverse connection protection, surge absorber, short-circuit protection		
Indicators		Operation indicator (red LED), operation set indicator (green LED)		
Material	Housing	Fluoroplastic coated brass		
	Sensing face	Fluoroplastic resin		
Weight (pre-wired models)		Approx. 120 g (4.23 oz)	Approx. 160 g (5.64 oz)	Approx. 220 g (7.76 oz)
Enclosure rating		IEC IP67		
Ambient temperature	Operating	-25°C to 70°C (-13°F to 158°F) with no icing		
Ambient humidity	Operating	35% to 95%		
Vibration resistance		10 to 55 Hz, 1.5-mm double amplitude for 2 hrs each in X, Y, and Z directions		
Shock resistance		1,000 m/s ² (3,280.8 ft/sec ²) approx. 100G for 10 times each in X, Y, and Z directions		
Insulation resistance		50 MΩ min. at 500 VDC between current carry parts and case		
Dielectric strength		1,000 VAC for 1 min between current carry parts and case		

Note: The response frequencies for DC switching are average values measured on condition that the distance between each sensing object is twice as large as the size of the standard object and the sensing distance set is half of the maximum sensing distance.

Operation

OUTPUT CIRCUIT DIAGRAM

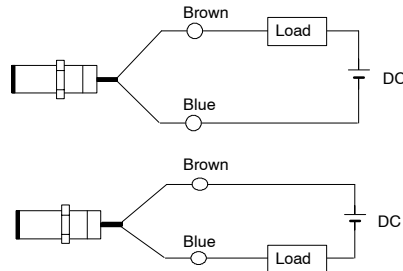
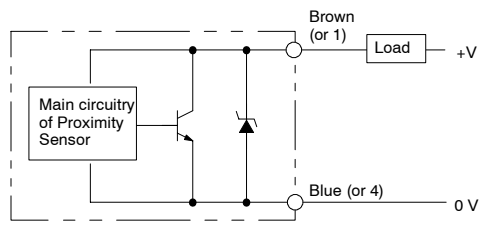

Note: It is possible to connect the load in two ways as shown in the above diagrams.

WIRING

E2EQ-X□D1-M1GJ

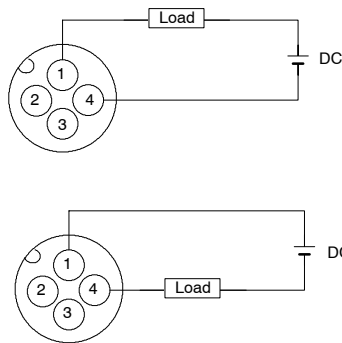

Note: Terminals 2 and 3 are not used.

TIMING CHART

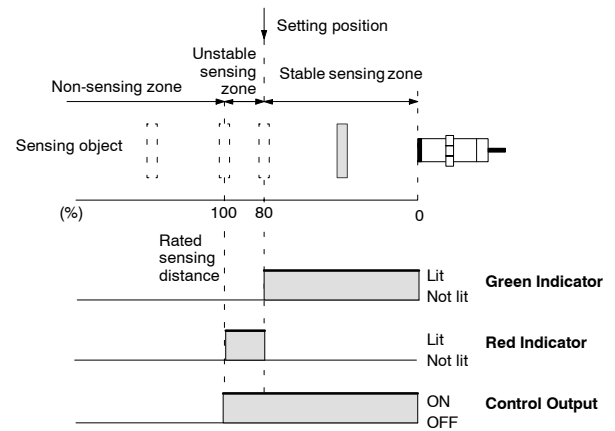

Engineering Data

OPERATING RANGE (TYPICAL)

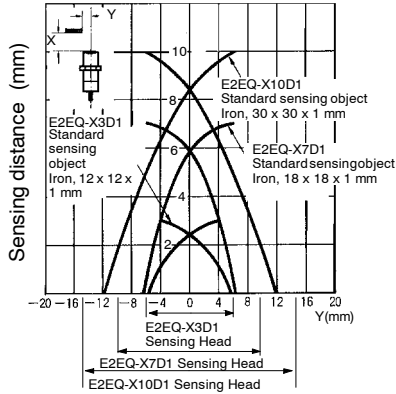

RESIDUAL OUTPUT VOLTAGE CHARACTERISTICS (TYPICAL)

E2EQ-X□D1

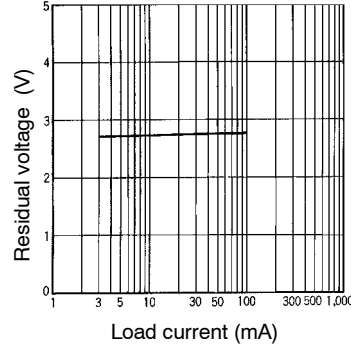

LEAKAGE CURRENT CHARACTERISTICS (TYPICAL)

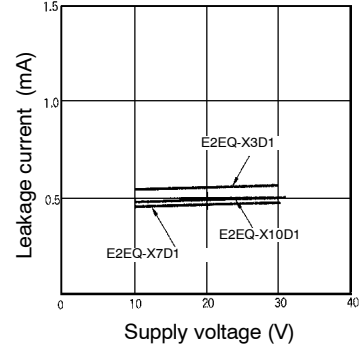

SENSING DISTANCE VS. SENSING OBJECT (TYPICAL)

E2EQ-X3D1

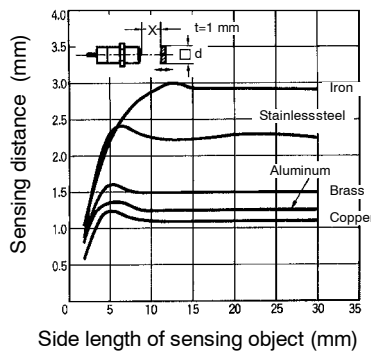

E2EQ-X7D1

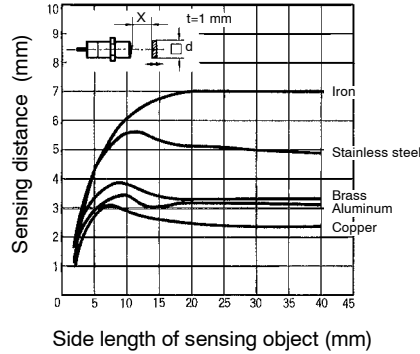

E2EQ-X10D1

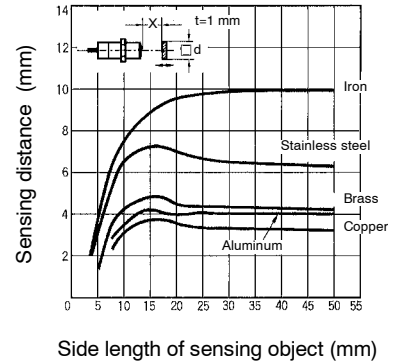

Dimensions

Unit: mm (inch)

■ SENSOR

E2EQ-X3D1

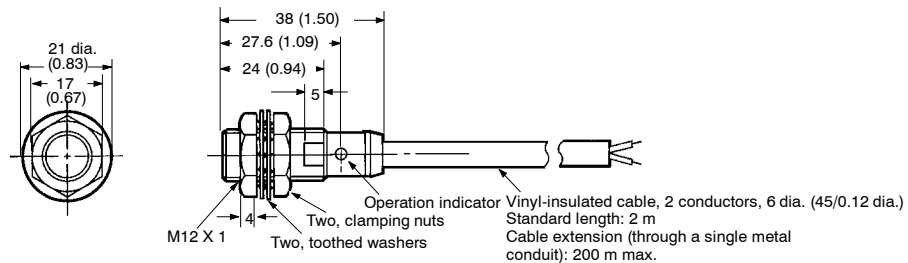

E2EQ-X7D1

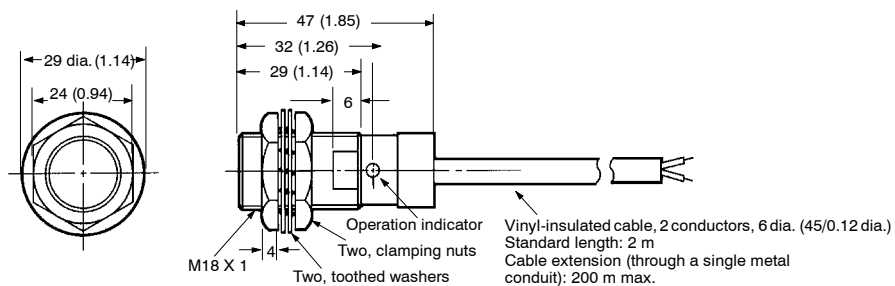

E2EQ-X10D1

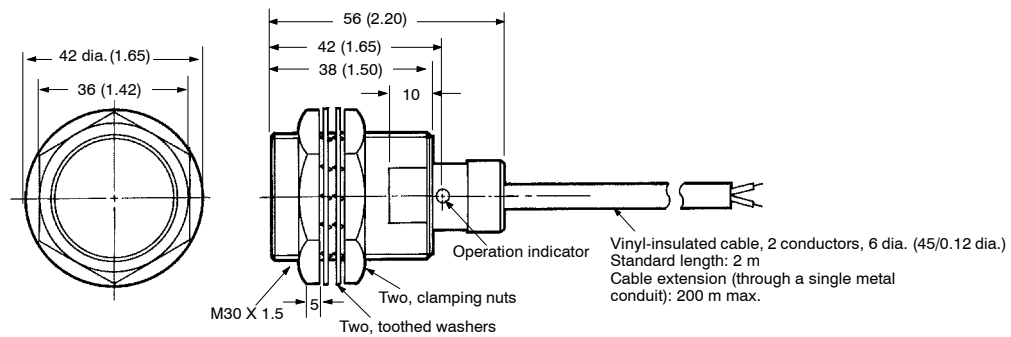

E2EQ-X3D1-M1GJ

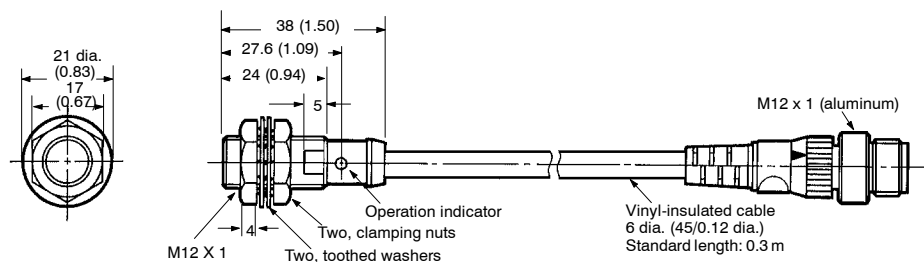

E2EQ-X7D1-M1GJ

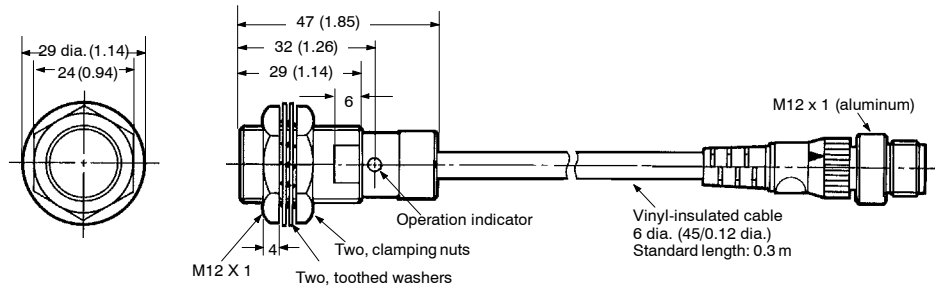

E2EQ-X10D1-M1GJ

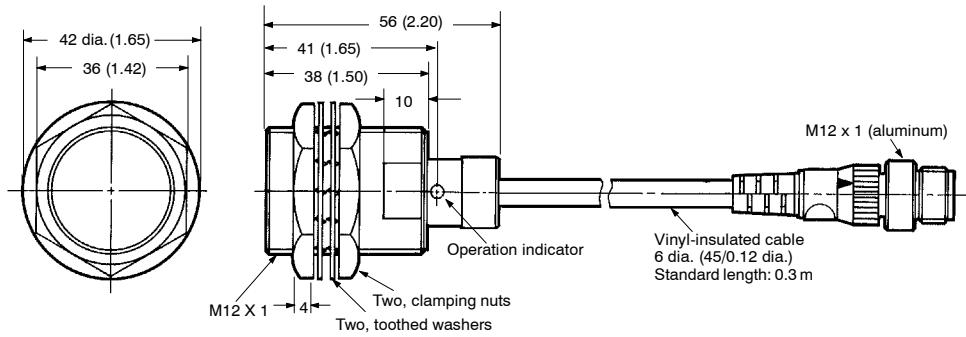

■ MOUNTING HOLE DIMENSIONS

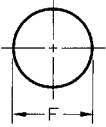

Models	F (mm)
E2EQ-X3	12.5 ^{+0.5} ₀ dia.
E2EQ-X7	18.5 ^{+0.5} ₀ dia.
E2EQ-X10	30.5 ^{+0.5} ₀ dia.

Precautions

■ INSTALLATION AND SURROUNDINGS

Do not tighten the nut with excessive force. A washer must be used with the nut.

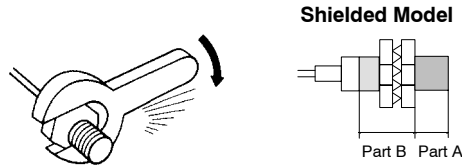

Note: The table below shows the tightening torques for part A and part B nuts. In the above example, the nut is on the sensor head side (part B) and hence the tightening torque for part B applies. If this nut is in part A, the tightening torque for part A applies instead.

Model	Part A		Part B
	Length	Torque	Torque
E2EQ-X3D1-□	24 mm	150 kgf • cm (11.1 ft • lbf) (15 N • m)	---
E2EQ-X7D1-□	29 mm		
E2EQ-X10D1-□	26 mm	400 kgf • cm (39 N • m) (28.7 ft • lbf)	800 kgf • cm (78 N • m)

■ EFFECTS OF SURROUNDING METAL

When mounting the E2EQ within a metal panel, ensure that the clearances given in the following table are maintained. Failure to maintain these distances may cause deterioration in the performance of the Sensor.

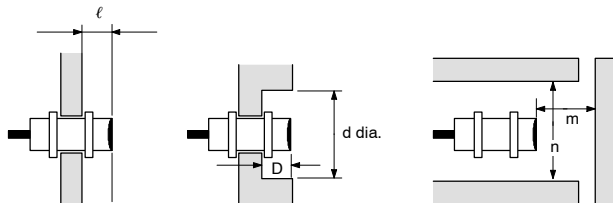

Model	E2EQ-X3D1-□	E2EQ-X7D1-□	E2EQ-X10D1-□
l	0 mm	0 mm	0 mm
d	12 mm (0.47 in)	18 mm (0.71 in)	30 mm (1.18 in)
D	0 mm	0 mm	0 mm
m	8 mm (0.31 in)	20 mm (0.79 in)	40 mm (1.57 in)
n	18 mm (0.71 in)	27 mm (1.06 in)	45 mm (1.77 in)

■ MUTUAL INTERFERENCE

When installing two or more E2EQ face-to-face or side-by-side, ensure that the minimum distances given in the following table are maintained.

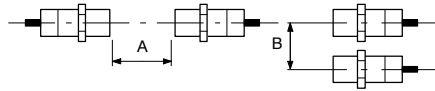

Model	A	B
E2EQ-X3D1-□	30 mm (1.18 in)	20 mm (0.79 in)
E2EQ-X7D1-□	50 mm (1.97 in)	35 mm (1.38 in)
E2EQ-X10D1-□	100 mm (3.93 in)	70 mm (2.76 in)

■ SENSING OBJECT

Sensing Object Material

The sensing distance is reduced for non-magnetic metals. The sensing distance for non-magnetic metal foils less than 0.01 mm thick is the same as that for magnetic metals. However, if the foil becomes so thin (e.g., from vaporization) that it loses its conductivity, then it will become undetectable.

Metal Plating

The sensing distance will change if the sensing object is plated. The following table shows the sensing distance of a plated object as a percentage of the sensing distance of an un-plated object.

Plating thickness	Iron	Brass
No plating	100%	100%
Zn 5 to 15 μ m	90% to 120%	95% to 105%
Cd 5 to 15 μ m	100% to 110%	95% to 105%
Ag 5 to 15 μ m	60% to 90%	85% to 100%
Cu 10 to 20 μ m	70% to 95%	95% to 105%
Cu 5 to 15 μ m	---	95% to 105%
Cu (5 to 10 μ m) + Ni (10 to 20 μ m)	75% to 95%	---
Cu (5 to 10 μ m) + Ni (10 μ m) + Cr (0.3 μ m)	75% to 95%	---

■ TURNING ON THE POWER

The proximity Sensor will begin sensing no later than 100 ms after the power is turned on. If the load and the Proximity Sensor operate on different power supplies, the Proximity Sensor must always be turned on first.

■ LEAKAGE CURRENT EFFECTS

Even when the Proximity Sensor is OFF, a small current will flow in the circuit (see *Leakage Current Characteristics*). If input to C-MOS or transistor, or other circuit element is unchanged due to leakage current, poor operation and inconsistency may result. In this case make sure that the bleeder resistance (R_2) is sufficient to dampen the leakage current.

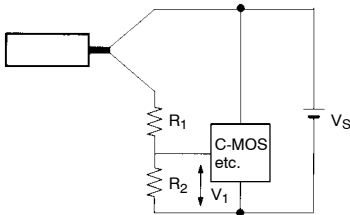

V_1 : operating voltage of the CMOS or other element (V_m, V_n)

i : load current ($i = 3$ to 100 mA)

R_2 : such that $i = 3$ to 100 mA when Proximity Sensor is ON

$$R1 = \frac{V_s - V_1 - V_2^*}{i} = \frac{V_s - V_2^*}{i} - R_2$$

* V_2 : Residual voltage

$$\frac{V_n}{i} < R_2 < \frac{V_n - V_2^*}{0.8 \text{ mA}}$$

**0.8 mA: Leakage current

■ PARALLEL CONNECTION (OR CIRCUIT)

When constructing OR circuits by connecting 2 or more Proximity Sensors in parallel, the leakage current through the load will be 0.8 mA times n , where n is the number of Proximity Sensors connected in parallel.

■ DIRECT CONNECTION TO A POWER SUPPLY

Never connect the Proximity Sensor directly to a power supply without a load in the circuit.

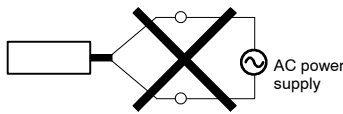
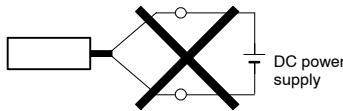

■ LOADS

When using relay or PC loads, remember that the residual voltage of the Proximity Sensor is 3 V (A 12-VDC relay cannot be switched)

■ SERIES CONNECTION (AND CIRCUIT)

When constructing AND circuits by connecting 2 or more Proximity Sensors in series, the voltage over the load V_L will be lower than power supply voltage V_S times n , where n is the number of Proximity Sensors connected in series.

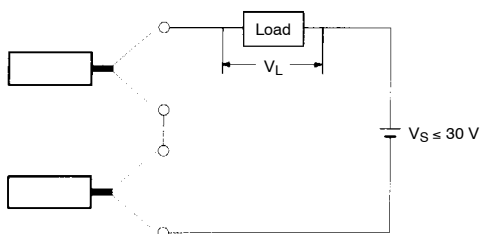

$$V_L = V_S - V_2 \times n$$

V_S : supply voltage
 n : number of Proximity Sensor
 V_2 : residual voltage

NOTE: DIMENSIONS SHOWN ARE IN MILLIMETERS. To convert millimeters to inches divide by 25.4.

OMRON[®]
OMRON ELECTRONICS LLC
One East Commerce Drive
Schaumburg, IL 60173
1-800-55-OMRON

OMRON ON-LINE
Global - <http://www.omron.com>
USA - <http://www.omron.com/oei>
Canada - <http://www.omron.com/oci>

OMRON CANADA, INC.
885 Milner Avenue
Scarborough, Ontario M1B 5V8
416-286-6465