

Flat-pack, Slim, DIN-rail Mount Pressure Sensor

- Withstands a pressure of 490 kPa (71 psi)
- Easy pressure setting with a two-turn pressure adjuster
- Linear analog output
- E8CC has digital display



Ordering Information

■ SENSOR

Digital display	Pressure range		ON/OFF output	Linear output	Part number
No	Positive pressure	0 to 98 kPa (0 to 14.2 psi)	NPN open collector	1 to 5 V	E8CB-01C
	Negative pressure	0 to -101 kPa (0 to -14.6 psi)			E8CB-CN0C2B
Yes	Positive pressure	0 to 98 kPa (0 to 14.2 psi)			E8CC-A01C
	Negative pressure	0 to -101 kPa (0 to -14.6 psi)			E8CC-AN0C
	Positive pressure	0 to 980 kPa (0 to 142.1 psi)			E8CC-B10C

Specifications

■ RATINGS/CHARACTERISTICS

Item/Model	E8CB-01C	E8CB-CN0C2B (See Note 2.)	E8CC-A01C	E8CC-AN0C (See Note 2.)	E8CC-B10C	
Supply voltage	12 to 24 VDC $\pm 10\%$ with a ripple (p-p) of 5% max.					
Current consumption	20 mA max.		30 mA max.			
Pressure type	Gauge pressure					
Permissible pressure range (See Note 2.)	Display value	0 to 1 kgf/cm ²	0 to -76 cmHg	0 to 98 kPa	0 to -101 kPa	0 to 980 kPa
	Reference value	0 to 98 kPa (0 to 14.2 psi)	0 to -101 kPa (0 to -14.6 psi)	--- (0 to 14.2 psi)	--- (0 to -14.6 psi)	--- (0 to 142.1 psi)
Pressure setting range (See Note 2.)	Display value	0 to 1 kgf/cm ²	0 to -76 cmHg	0 to 98 kPa	0 to -101 kPa	0 to 980 kPa
	Reference value	0 to 98 kPa (0 to 14.2 psi)	0 to -101 kPa (0 to -14.6 psi)	---	---	---
Pressure indication unit	---			kPa		
Withstand pressure	490 kPa (71 psi)		490 kPa (71 psi)		1.5 MPa (217.5 psi)	
Applicable material	Noncorrosive and nonflammable gases					
Repeat accuracy (ON/OFF output)	$\pm 1\%$ FS max.					
Accuracy (linear output)	$\pm 3\%$ FS max.					
Differential travel (ON/OFF output)	2% FS max.					
Linearity (linear output)	$\pm 1\%$ FS max.					
Response time	5 ms max.					
Linear output	1 to 5 V with an output impedance of 20 Ω and a permissible resistive load of 10 k Ω min.					
ON/OFF output	NPN open collector					
	Load current	80 mA max.				
	Output applied voltage	30 VDC max.				
	Residual voltage	1 V max. (with a load current of 80 mA) and 0.4 V max. (with a load current of 20 mA)				
Circuit protection	Reversed power supply connection and load short-circuiting					
Display (See Note 1.)	Red LED ON with output transistor turned ON		2 ¹ / ₂ -digit display Red LED ON with output transistor turned ON			
Display accuracy	---		$\pm 3\%$ FS ± 1 digit max. within a temperature range from 0°C to 50°C (32°F to 122°F)			
			$\pm 4\%$ FS ± 1 digit max. within a temperature range from 50°C to 55°C (122°F to 131°F)			
			$\pm 5\%$ FS ± 1 digit max. within a temperature range from 0°C to -10°C (32°F to 14°F)			

Item/Model	E8CB-01C	E8CB-CN0C2B (See Note 2.)	E8CC-A01C	E8CC-AN0C (See Note 2.)	E8CC-B10C
Ambient temperature	Operating: -10°C to 55°C (14°F to 131°F) with no icing Storage: -25°C to 70°C (-13°F to 158°F) with no icing				
Ambient humidity	Operating/Storage: 35% to 95% (with no icing)				
Temperature influence	±0.12% FS/°C between 0°C and 50°C (32°F to 122°F) and ±0.2% FS/°C max. between -10°C and 0°C or 50°C and 55°C (122°F to 131°F)				
Voltage influence	±1.5% FS max.				
Insulation resistance	50 MΩ min. (at 500 VDC) between current carrying parts and case				
Dielectric strength	1,000 VAC for 1 min				
Vibration resistance	10 to 500 Hz, 1.5-mm double amplitude or 100 m/s ² (328 ft/s ²) for 2 hours each in X, Y, and Z directions				
Shock resistance	1,000 m/s ² (3280 ft/s ²) 3 times each in X, Y, and Z directions				
Degree of protection (See Note 3.)	IEC60529 IP50				
Pressure port	Aluminum				
Connection method	Prewired (standard cable length: 2 m)				
Weight	Approx. 70 g (2.47 oz)		Approx. 80 g (2.82 oz)		
Pressure port	NPT 1/8 and M5 female screws				

Note: 1. The 2¹/₂-digit display refers to a display in which the third digit displays only 0 or 1.

3rd digit 2nd digit 1st digit

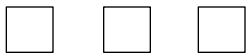

0 or 1 0 to 9 0 to 9

- These models are negative-pressure models.
- E8CB and E8CC are not oil resistant or water resistant.

Engineering Data

■ TEMPERATURE VS LINEAR OUTPUT FLUCTUATION (TYPICAL)

E8CB-01C

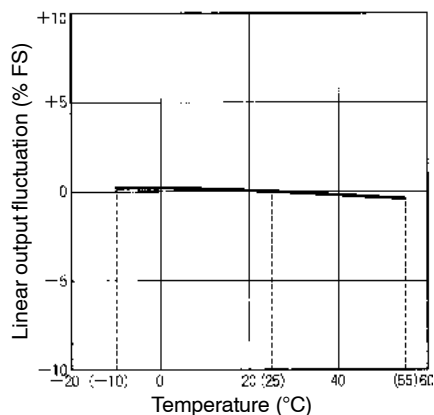

■ PRESSURE VS LINEAR OUTPUT VOLTAGE (TYPICAL)

E8CB-01C

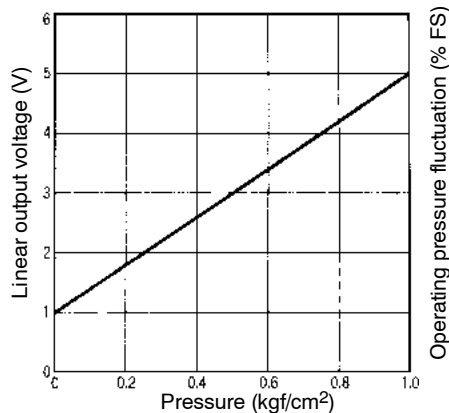

■ TEMPERATURE VS OPERATING PRESSURE (TYPICAL)

E8CB-01C

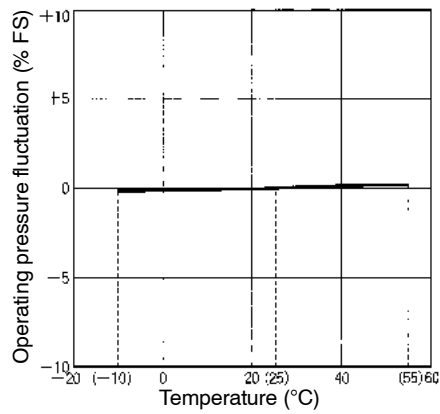

■ LINEARITY (TYPICAL)

E8CB-01C

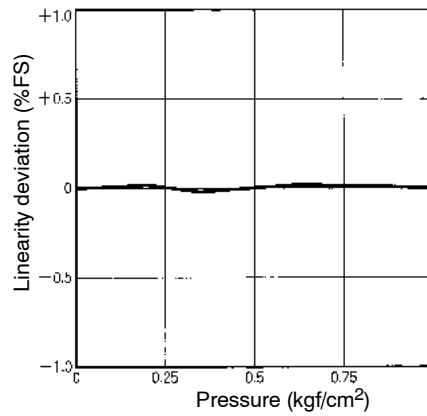

■ VOLTAGE VS. OPERATING PRESSURE FLUCTUATION (TYPICAL)

E8CB-01C

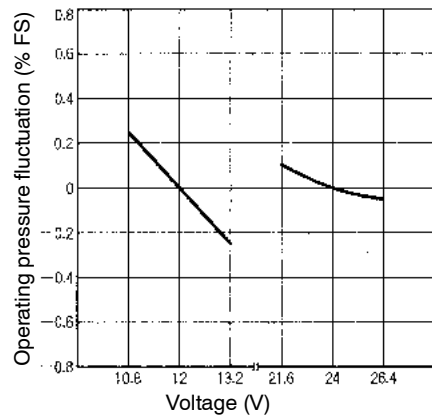

■ VOLTAGE VS. LINEAR OUTPUT FLUCTUATION (TYPICAL)

E8CB-01C

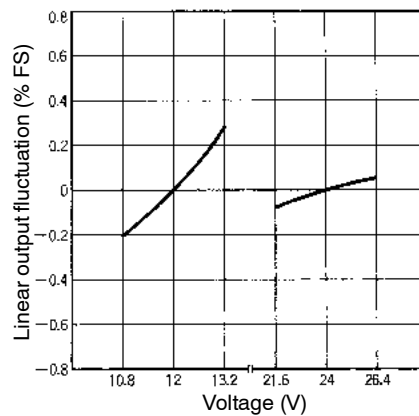

■ TEMPERATURE VS. LINEAR OUTPUT FLUCTUATION (TYPICAL)

E8CC-A01C

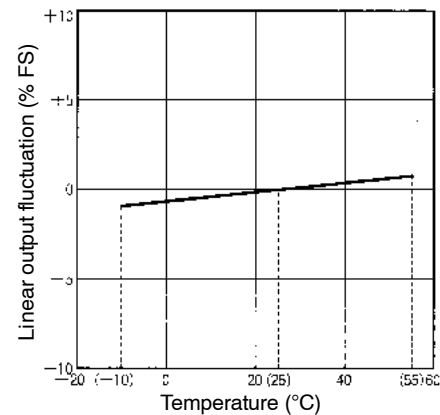

■ PRESSURE VS. LINEAR OUTPUT VOLTAGE (TYPICAL)

E8CC-A01C

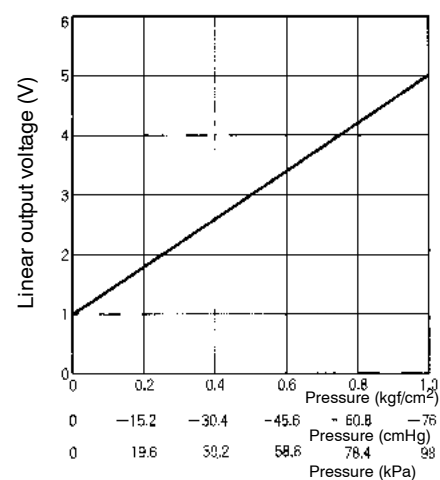

TEMPERATURE VS. OPERATING PRESSURE (TYPICAL)

E8CC-A01C

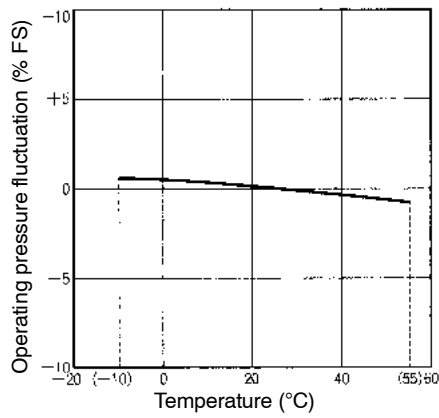

LINEARITY (TYPICAL)

E8CC-A01C

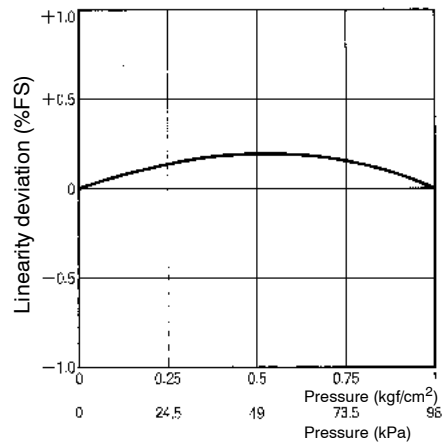

VOLTAGE VS. OPERATING PRESSURE FLUCTUATION (TYPICAL)

E8CC-AN0C

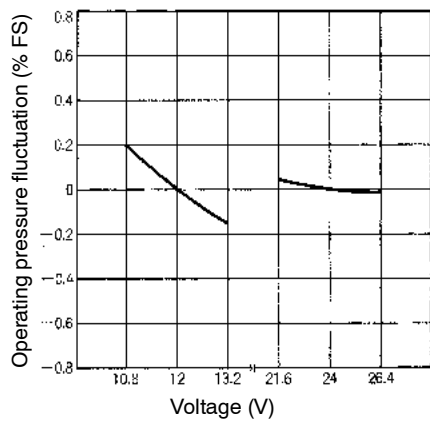

VOLTAGE VS. LINEAR OUTPUT FLUCTUATION (TYPICAL)

E8CC-AN0C

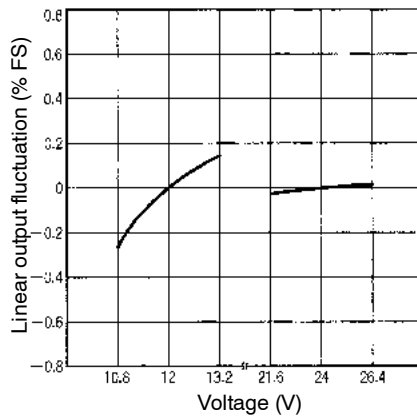

Operation

■ E8CB/E8CC PRESSURE SENSOR

Output configuration	Model	Timing Charts	Output Circuits
NPN output	E8CB-01C, E8CC-A01C, E8CC-B10C	<p>Pressure (kgf/cm²)</p> <p>Setting</p> <p>Output</p> <p>Indicator</p>	<p>Operation indicator</p> <p>Main circuit</p> <p>Brown</p> <p>White (ON/OFF)</p> <p>Black (linear output)</p> <p>Blue</p> <p>+V</p> <p>0V</p> <p>Load</p> <p>Load</p>
	E8CB-CN0C2B, E8CC-AN0C	<p>Pressure (cmHg)</p> <p>Setting</p> <p>Output</p> <p>Indicator</p>	

■ CORRECT USE

Adjustment (E8CC)

1. Set the mode selector to SET.

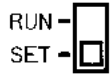

2. Turn the pressure adjuster to the desired pressure.

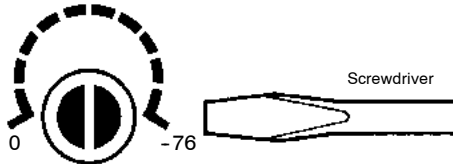

3. Set the mode selector to RUN.



The E8CC has normal output in the SET mode. Changing the pressure setting is possible in RUN mode by turning the pressure adjuster. Do not turn the pressure adjuster after it has been set to the desired pressure.

Indication

Display	Mode	Operating status	Description	Permissible range		
				Positive pressure		Negative pressure
				E8CC-A01C	E8CC-B10C	E8CC-AN0C
30 (for 30 kPa)	RUN	Normal	Displays pressure within the permissible range.	0 to 98 kPa (0 to 14.2 psi)	0 to 980 kPa (0 to 142.1 psi)	0 to -101 kPa (0 to -14.6 psi)
	SET	Normal	Displays the ON-point pressure within the permissible range			
--	RUN	Abnormal pressure imposition	Positive Pressure: Indicates that the imposed pressure is lower than the permissible range. Negative Pressure: Indicates that the imposed pressure is higher than the permissible range. The E8CC is in normal output operation in both cases.			
	SET	Abnormal pressure setting	Positive Pressure: Indicates that ON-point pressure value is lower than the permissible range. Negative Pressure: Indicates that ON-point pressure is higher than the permissible range. The E8CC is in normal output operation in both cases.			
FF	RUN	Abnormal pressure imposition	Indicates that the imposed pressure is higher than the permissible range.			---
	SET	Abnormal pressure setting	Positive Pressure: Indicates that ON-point pressure value is higher than the permissible range. Negative Pressure: Indicates that ON-point pressure is lower than the permissible range. The E8CC is in normal output operation in both cases.			0 to -101 kPa (0 to -14.6 psi)
LE	RUN	Load overcurrent	Indicates that the output transistor has excessive load current. The result is that the output of the E8CC is turned OFF. This display flashes until the condition returns to normal. Check the output wiring if this display flashes.			
	SET					
SH	RUN	Element destruction	Indicates that the Pressure Sensor element is damaged due to the imposition of excessive pressure or for other reasons, in which case the output of the E8CC turns OFF. If this display appears, the E8CC can no longer be used.			
	SET					

Dimensions

Unit: mm (inch)

■ E8CB

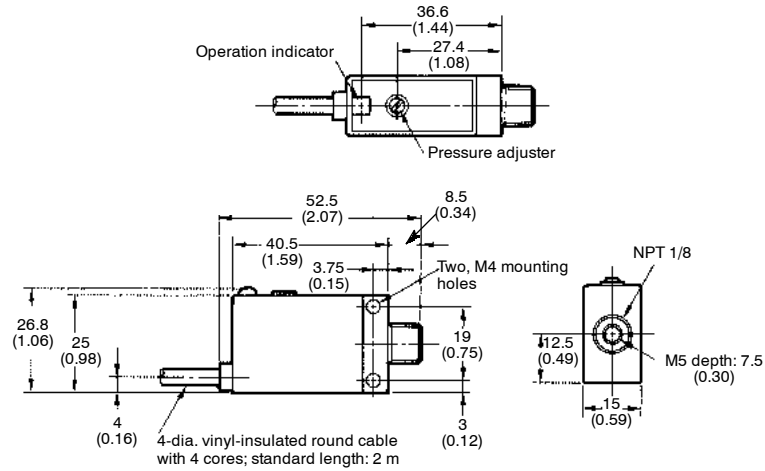
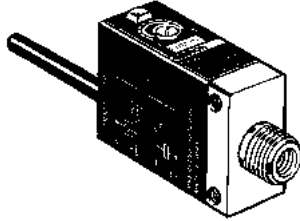

■ E8CC

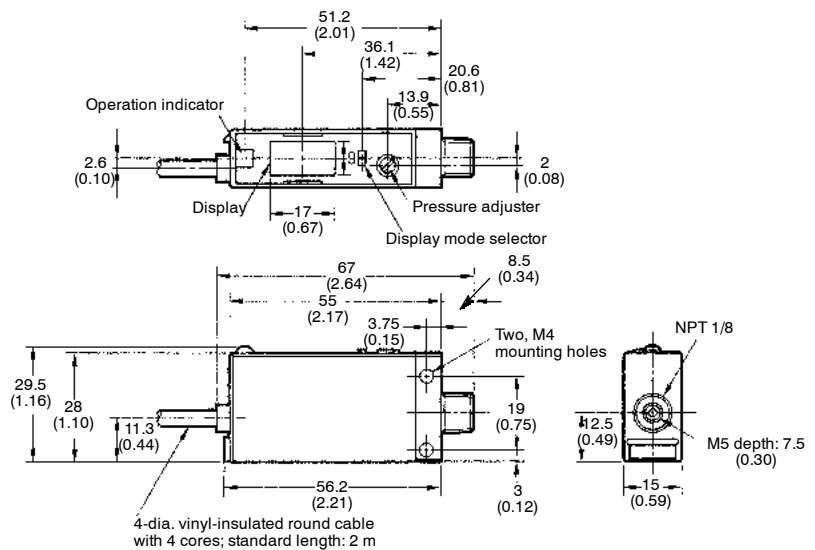
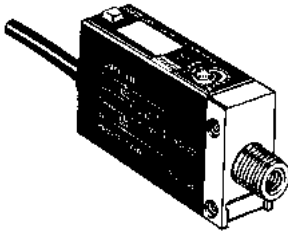

■ MOUNTED TO A DIN-RAIL MOUNTING BRACKET

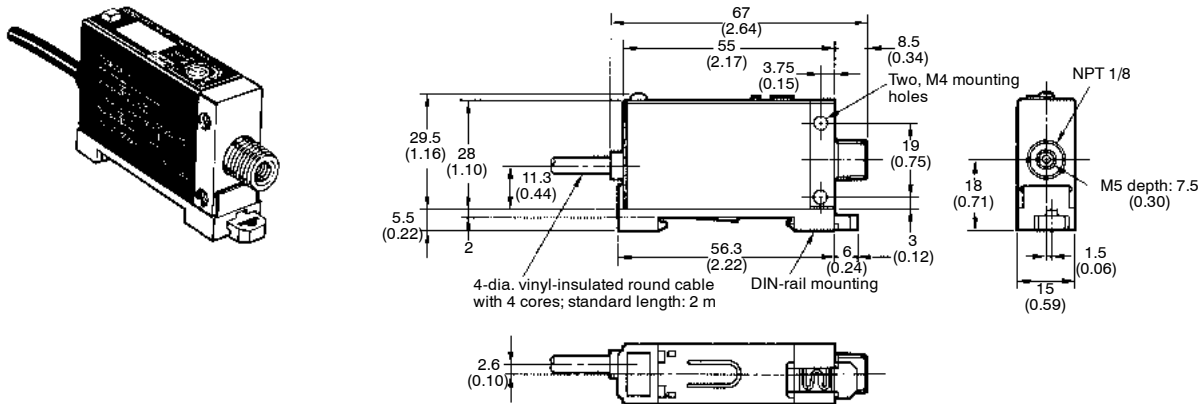

Precautions

■ MOUNTING

Diaphragm

If the diaphragm is damaged, the Pressure Sensor will not operate correctly. Do not insert a screwdriver or steel wire into the pressure port.

The pressure port has an NPT 1/8 taper screw and M5 female screw. Apply sealing tape around the female taper screw so that no pressure leakage will occur.

Make sure that the tightening torque of the M5 female screw is 3.9 N · m (2.87 ft · lbs) or less.

If the Pressure Sensor is directly connected to a conduit, be sure to apply a wrench to the pressure port, not to the plastic case.

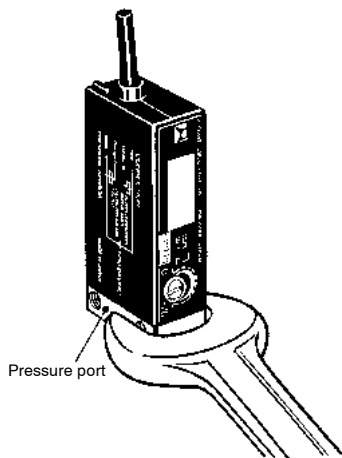

■ DIN-RAIL MOUNTING BRACKET (E8CC)

Mounting

- Fit the front part onto the bracket.
- Press the rear part onto the bracket.

Removing

- Apply a flat-blade screwdriver to the rear hook. Then the Pressure Sensor can be removed easily.

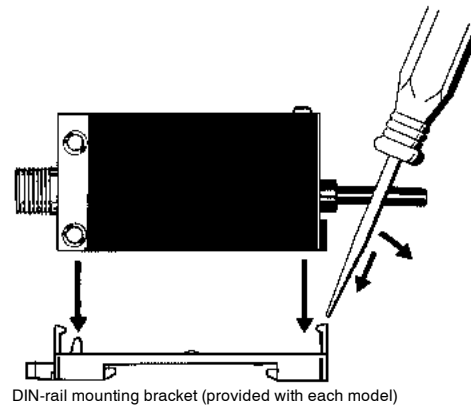

■ WIRING

If no linear output is used, cut off the black lead wire and apply insulation tape to the lead wire so that it will not come in contact with any other terminal.

NOTE: DIMENSIONS SHOWN ARE IN MILLIMETERS. To convert millimeters to inches divide by 25.4.

OMRON[®]
OMRON ELECTRONICS LLC
One East Commerce Drive
Schaumburg, IL 60173
1-800-55-OMRON

OMRON ON-LINE
Global - <http://www.omron.com>
USA - <http://www.omron.com/oei>
Canada - <http://www.omron.com/oci>

OMRON CANADA, INC.
885 Milner Avenue
Scarborough, Ontario M1B 5V8
416-286-6465