

FEATURES

- **HIGH ISOLATION VOLTAGE**
BV: 5 k Vr.m.s. MIN
- **AC INPUT RESPONSE**
- **HIGH SPEED SWITCHING**
 $t_r, t_f = 100 \mu\text{s}$ TYP
- **ULTRA HIGH CURRENT TRANSFER RATIO**
CTR: 2000% TYP

DESCRIPTION

PS2607, PS2607L, PS2608, and PS2608L are optically coupled isolators containing a GaAs light emitting diode and an NPN silicon Darlington-connected phototransistor. PS2607, PS2608 are in a plastic DIP (Dual In-Line Package). PS2607L, PS2608L are lead bending type (Gull-wing) for surface mount. PS2607 and PS2607L have a base pin and PS2608 and PS2608L have no base pin.

APPLICATIONS

Interface circuit for various instrumentations, and control equipment.

- **AC LINE/DIGITAL LOGIC**
- **DIGITAL LOGIC/DIGITAL LOGIC**
- **TWISTED PAIR LINE RECEIVER**
- **TELEPHONE/TELEGRAPH LINE RECEIVER**
- **HIGH FREQUENCY POWER SUPPLY FEEDBACK CONTROL**

ELECTRICAL CHARACTERISTICS (T_A = 25°C)

| PART NUMBER | | | PS2607, PS2607L, PS2608, PS2608L | | | |
|----------------|---|---|----------------------------------|-----|------|-----|
| | SYMBOLS | PARAMETERS | UNITS | MIN | TYP | MAX |
| Diode | V _F | Forward Voltage, I _F = ±10 mA | V | | 1.1 | 1.4 |
| | C | Junction Capacitance, V = 0, f = 1.0 MHz | pF | | 60 | |
| Transistor | I _{CEO} | Collector to Emitter Dark Current, V _{CE} = 40 V, I _F = 0 | nA | | | 400 |
| | BV _{CEO} | Collector to Emitter Breakdown Voltage, I _C = 1 mA, I _B = 0 | V | 40 | | |
| | BV _{ECO} | Emitter to Collector Breakdown Voltage, I _E = 100 μA, I _B = 0 | V | 6 | | |
| Coupled | CTR | Current Transfer Ratio, I _F = ±1 mA, V _{CE} = 2 V | % | 200 | 2000 | |
| | CTR1/CTR2 | CTR (Ratio) ¹ , I _F = ±1 mA, V _{CE} = 2 V | | 0.3 | 1.0 | 3.0 |
| | V _{CE(sat)} | Collector Saturation Voltage, I _F = ±1 mA, I _C = 2 mA | V | | | 1.0 |
| | R1-2 | Isolation Resistance, V _{in-out} = 1.0 k V | Ω | 10 | | |
| | C1-2 | Isolation Capacitance, V = 0, f = 1.0 MHz | pF | | 0.6 | |
| | t _r | Rise Time ² , V _{CC} = 10 V, I _C = 10 mA | μs | | 100 | |
| t _f | Fall Time ² , V _{CC} = 10 V, I _C = 10 mA | μs | | 100 | | |

1. $CTR_1 = \frac{I_{C1}}{I_{F1}}$ $CTR_2 = \frac{I_{C2}}{I_{F2}}$

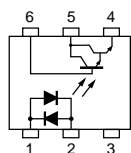
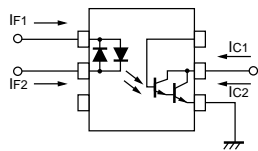

PS2607

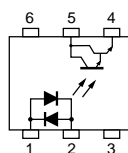

PS2608

2. Test Circuit for Switching Time

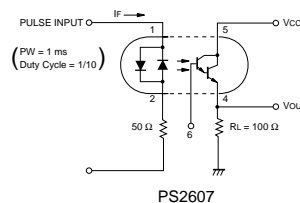

PS2607

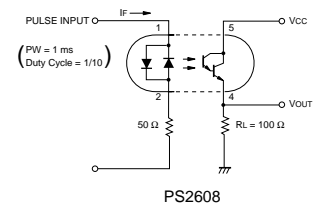

PS2608

PS2607, PS2608, PS2607L, PS2608L

ABSOLUTE MAXIMUM RATINGS¹ (T_A = 25°C)

| SYMBOLS | PARAMETERS | UNITS | RATINGS |
|-----------------------|--|---------------------|-------------|
| Diode | | | |
| I _F | Forward Current (DC) | mA | 80 |
| P _D | Power Dissipation | mW | 150 |
| I _F (Peak) | Peak Forward Current PW = 100 μs, Duty Cycle 1% | A | 1 |
| Transistor | | | |
| V _{CEO} | Collector to Emitter Voltage | V | 40 |
| V _{ECO} | Emitter to Collector Voltage | V | 6 |
| I _C | Collector Current | mA | 200 |
| P _C | Power Dissipation | mW | 200 |
| Coupled | | | |
| BV | Isolation Voltage ² | V _{r.m.s.} | 5000 |
| T _{STG} | Storage Temperature | °C | -55 to +150 |
| T _{OP} | Operating Temperature | °C | -55 to +100 |

Notes:

1. Operation in excess of any one of these parameters may result in permanent damage.
2. AC voltage for 1 minute at T_A = 25 °C, RH = 60 % between input (Pins No. 1, 2, 3 Common) and output (Pins No. 4, 5, 6 Common).

OUTLINE DIMENSIONS (Units in mm)

PS2607, PS2608

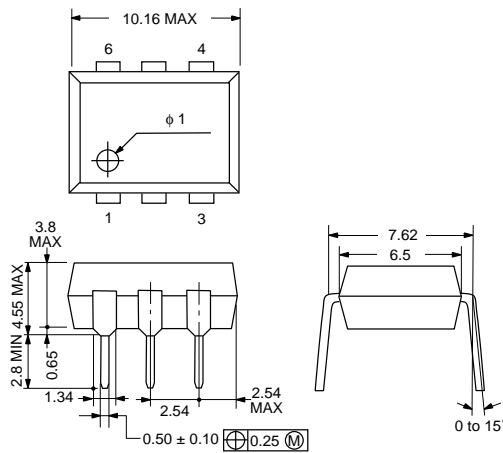

PS2607L, PS2608L

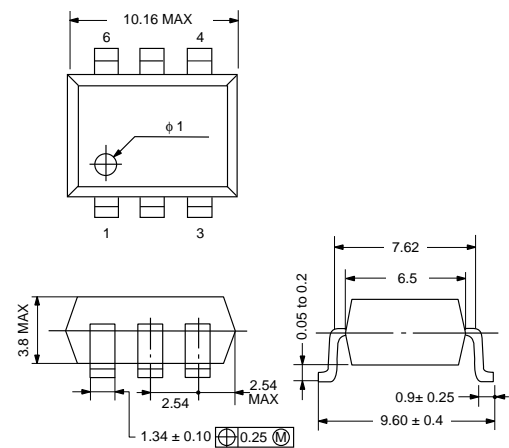

PIN CONNECTIONS (Top View)

PS2607, PS2607L

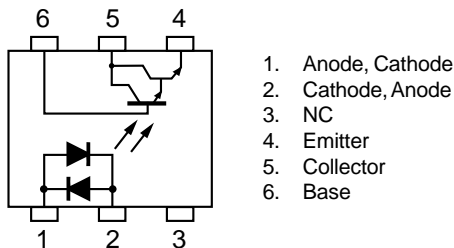

PS2608, PS2608L

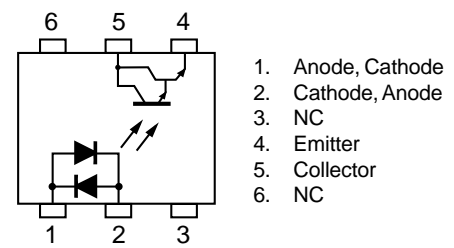

TYPICAL PERFORMANCE CURVES ($T_A = 25\text{ }^\circ\text{C}$)

DIODE POWER DISSIPATION vs. AMBIENT TEMPERATURE

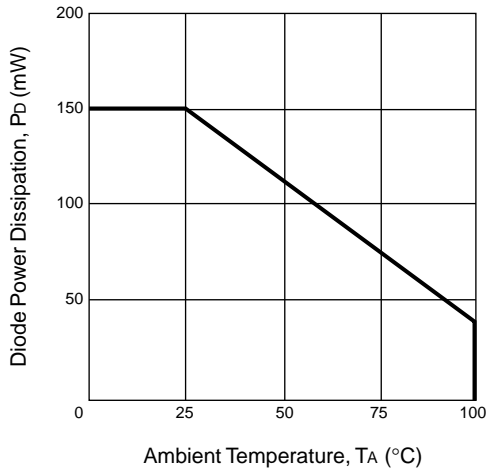

TRANSISTOR POWER DISSIPATION vs. AMBIENT TEMPERATURE

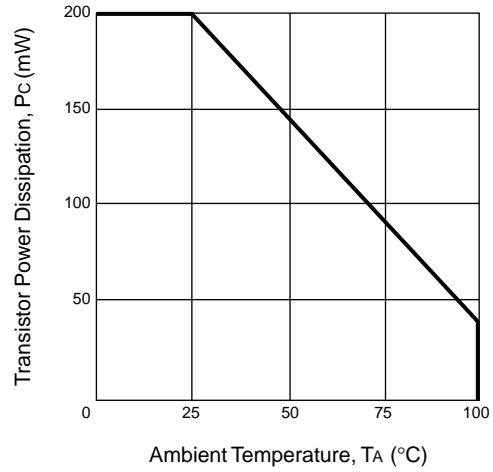

FORWARD CURRENT vs. FORWARD VOLTAGE

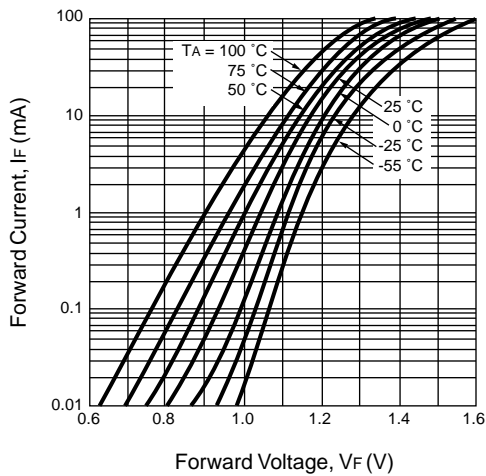

FORWARD CURRENT vs. FORWARD VOLTAGE

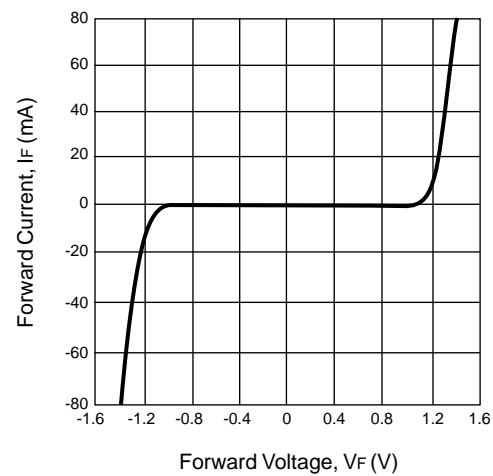

COLLECTOR TO EMITTER DARK CURRENT vs. AMBIENT TEMPERATURE

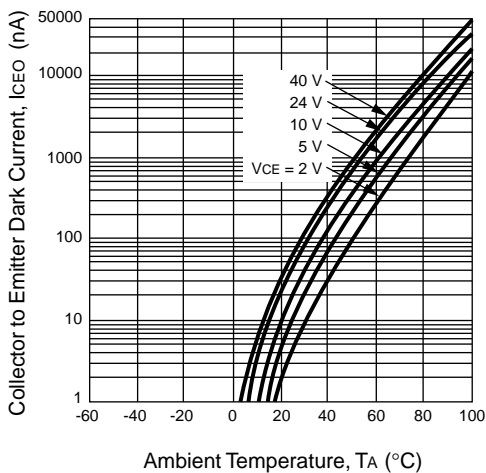

COLLECTOR CURRENT vs. COLLECTOR SATURATION VOLTAGE

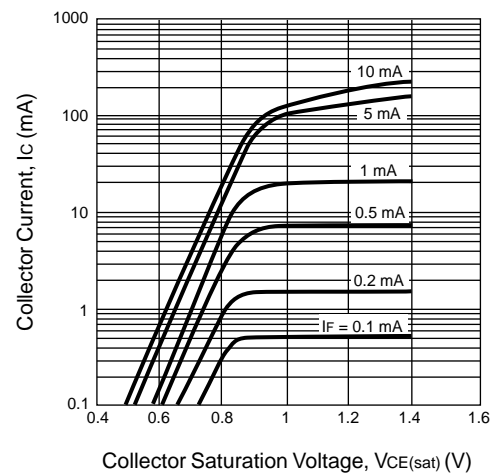

TYPICAL PERFORMANCE CURVES (TA = 25 °C)

