

## HDSP-56xC Series

13 mm Slim Font

Seven Segment Displays



## Data Sheet

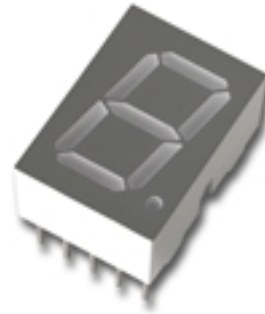

### Description

The Slim Font Seven Segment Displays incorporates a new slim font character design. This slim font features narrow width, specially mitered segments to give fuller appearance to the illuminated character. Faces of these displays are painted a neutral gray for enhanced on/off contrast.

All devices are available in either common anode or common cathode configuration with right hand decimal point.

### Features

- **As AlInGaP red color**
- **Gray Face Paint**  
Gray package gives optimum contrast
- **Design flexibility**  
Common anode or common cathode
- **Excellent appearance**
- **Slim font design**
- **Mitered corners, evenly illuminated segments**

### Devices

| <b>As AlInGaP Red</b> | <b>Description</b> |
|-----------------------|--------------------|
| HDSP-561C             | Common Anode       |
| HDSP-563C             | Common Cathode     |

## Part Numbering System

5082 -X X X X-X X X X X

HDSP-X X X X-X X X X X

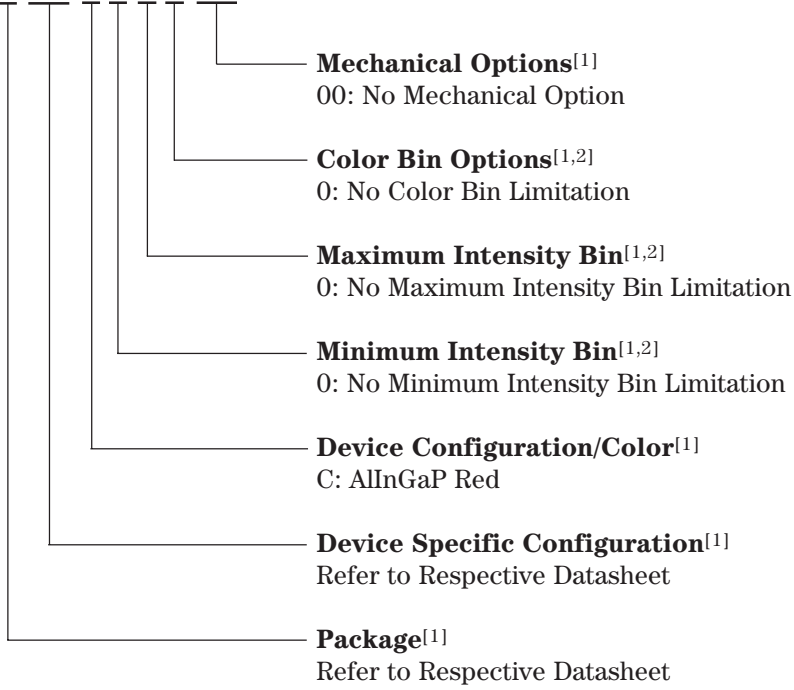

### Notes:

1. For codes not listed in the figure above, please refer to the respective datasheet or contact your nearest Avago representative for details.
2. Bin options refer to shippable bins for a part number. Color and Intensity Bins are typically restricted to 1 bin per tube (exceptions may apply). Please refer to respective datasheet for specific bin limit information.

# Package Dimensions and Internal Circuit

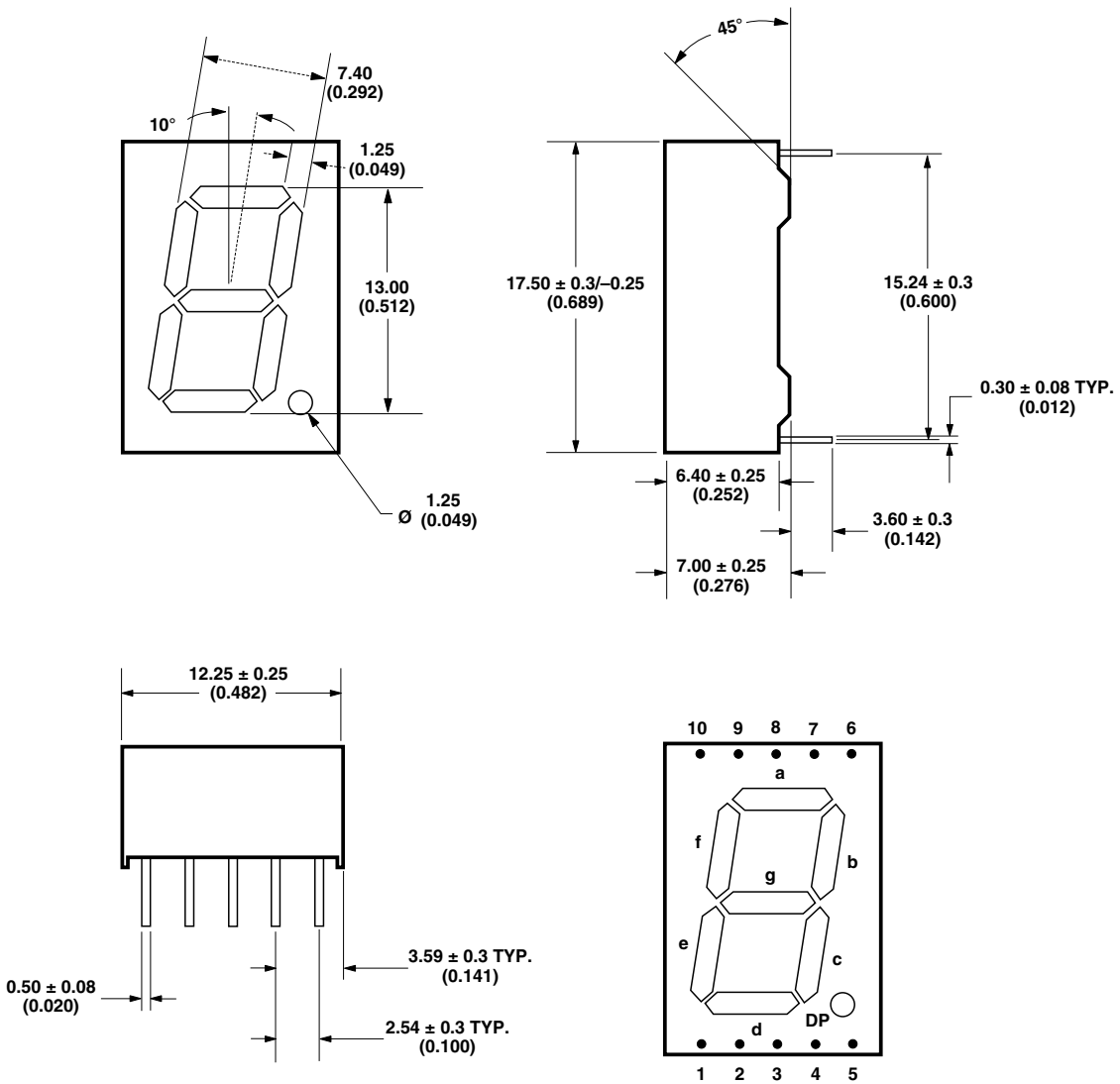

NOTES:  
 1. ALL DIMENSIONS ARE IN MILLIMETERS (INCHES).  
 2. UNLESS OTHERWISE STATED, TOLERANCES ARE  $\pm 0.25$  MM.

| Pin | Function   |
|-----|------------|
| 1   | E          |
| 2   | D          |
| 3   | Common A/C |
| 4   | C          |
| 5   | DP         |
| 6   | B          |
| 7   | A          |
| 8   | Common A/C |
| 9   | F          |
| 10  | G          |

## Absolute Maximum Ratings at $T_A = 25^\circ\text{C}$

| Description  | Symbol      | HDSP-561C/563C | Units            |
|--|-------------|----------------|------------------|
| DC Forward Current per Segment or DP <sup>[1,2,3]</sup>        | $I_F$       | 50             | mA               |
| Peak Forward Current per Segment or DP <sup>[2,3]</sup>        | $I_{PEAK}$  | 100            | mA               |
| Average Forward Current <sup>[3]</sup>                         | $I_{AVE}$   | 30             | mA               |
| Reverse Voltage per Segment or DP ( $I_R = 100\ \mu\text{A}$ ) | $V_R$       | 5              | V                |
| Operating Temperature  | $T_O$       | -40 to +105    | $^\circ\text{C}$ |
| Storage Temperature  | $T_S$       | -40 to +120    | $^\circ\text{C}$ |
| Wave Soldering Conditions                                      | Temperature | 250            | $^\circ\text{C}$ |
|  | Time        | 3              | s                |

### Notes:

- Derate linearly as shown in Figure 1.
- For long term performance with minimal light output degradation, drive currents between 10 mA and 30 mA are recommended. For more information on recommended drive conditions, please refer to Application Brief I-024 (5966-3087E).
- Operating at currents below 1 mA is not recommended. Please contact your local representative for further information.

## Optical/Electrical Characteristics at $T_A = 25^\circ\text{C}$

| Device Series | Parameter                          | Symbol                | Min.  | Typ. | Max. | Units | Test Conditions  |
|---------------|------------------------------------|-----------------------|-------|------|------|-------|--|
| 561C          | Forward Voltage                    | $I_V$                 |       | 1.90 | 2.40 | V     | $I_F = 20\ \text{mA}$  |
| 563C          | Reverse Voltage                    | $V_R$                 | 5     |      |      | V     | $I_F = 100\ \mu\text{A}$   |
|               | Peak Wavelength                    | $\lambda_{PEAK}$      |       | 635  |      | nm    | Peak Wavelength of Spectral Distribution at $I_F = 20\ \text{mA}$                  |
|               | Dominant Wavelength <sup>[3]</sup> | $\lambda_d$           | 622.5 | 626  | 630  | nm    |  |
|               | Spectral Halfwidth                 | $\Delta\lambda_{1/2}$ |       | 40   |      | nm    | Wavelength Width at Spectral Distribution 1/2 Power Point at $I_F = 20\ \text{mA}$ |
|               | Speed of Response                  | $\tau_S$              |       | 20   |      | ns    | Exponential Time Constant, $e^{-\tau_S}$   |
|               | Capacitance                        | C                     |       | 40   |      | pF    | $V_F = 0, f = 1\ \text{MHz}$   |

## Intensity Bin Limits<sup>[1]</sup>

(mcd at 10 mA)

| Bin Name | Min. <sup>[2]</sup> | Max. <sup>[2]</sup> |
|----------|---------------------|---------------------|
| T        | 18.000              | 25.000              |
| U        | 25.001              | 36.000              |

### Notes:

- Bin categories are established for classification of products. Products may not be available in all bin categories.
- Tolerance for each bin limit is  $\pm 10\%$ .

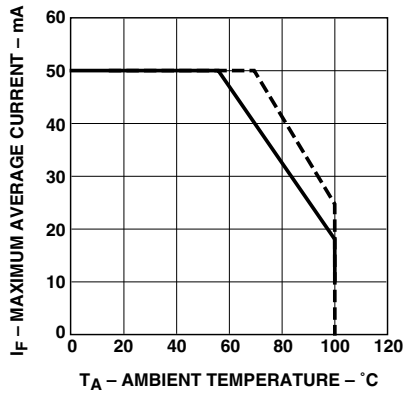

Figure 1. Maximum forward current vs. ambient temperature. Derating based on  $T_{JMAX} = 130^{\circ}C$ .

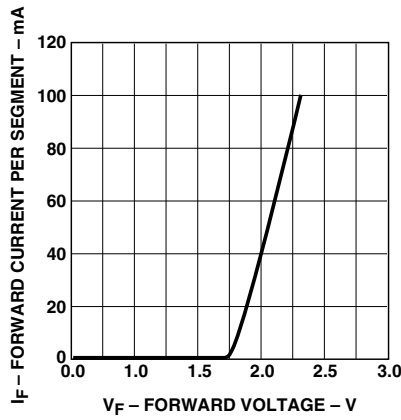

Figure 2. Forward current vs. forward voltage.

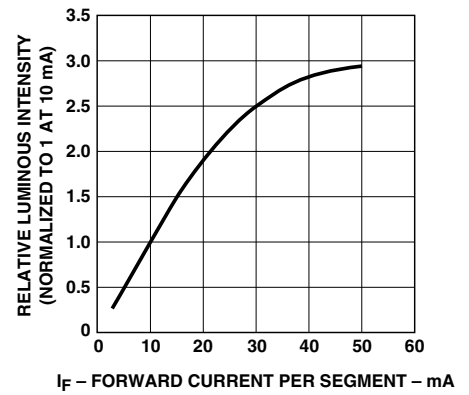

Figure 3. Relative luminous intensity vs. DC forward current.

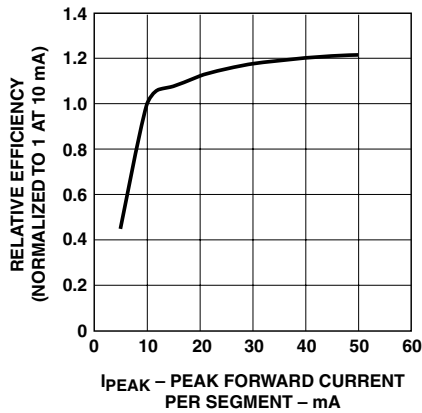

Figure 4. Relative efficiency (luminous intensity per unit current) vs. peak current.

### Contrast Enhancement

For information on contrast enhancement, please see Application Note 1015.

### Soldering/Cleaning

Cleaning agents from ketone family (acetone, methyl ethyl ketone, etc.) and from the chlorinated hydrocarbon family (methylene chloride, trichloroethylene, carbon tetrachloride, etc.) are not recommended for cleaning LED parts. All of these various solvents attack or dissolve the encapsulating epoxies used to form the package of plastic LED parts.

For information on soldering LEDs, please refer to Application Note 1027.

For product information and a complete list of distributors, please go to our website: [www.avagotech.com](http://www.avagotech.com)

Avago, Avago Technologies, and the A logo are trademarks of Avago Technologies Limited in the United States and other countries.  
Data subject to change. Copyright © 2006 Avago Technologies Limited. All rights reserved.  
5988-4823EN May 31, 2006

