



iChip™ CO2064SEC Secure Ethernet Controller

General Description

iChip™ CO2064SEC is the most full-featured, lowest-cost Secure Ethernet Controller chip on the market today. CO2064SEC acts as a co-processor to offload security and IP connectivity tasks from any host processor. The Secure Ethernet Controller is ideal for enabling devices to achieve secure, high-speed throughput and access to IP networks via 10/100BaseT LAN. Typically, only one man-month is needed for hardware engineering and adding IP connectivity commands to the application.

The CO2064SEC firmware comes in two distinct flavors:

- Flavor **A** offers 10 active TCP/UDP sockets and two listening sockets; sending plain-text e-mails; sending and retrieving data from an FTP server; serial-to-IP bridging in SerialNET™ mode, and an HTTP client.
- Flavor **B** offers one secure SSL3/TLS1 socket plus 9 non-secure sockets and a Network Time Client.

Flavors can be quickly interchanged at will simply by sending an appropriate AT+i™ command for uploading a different flavor.

Security features include a random number generator, SHA-1/256 secure hash accelerator, AES-128/192/256 encryption accelerator, 3DES, and SSL3/TLS1.

The CO2064SEC uses an open software architecture that allows users to select and program the firmware flavor that provides the Internet protocols and other features required for their application.

CO2064SEC loads its firmware and Internet configuration parameters either from an external SPI flash memory or accepts it from the host via one of the supported interfaces.

The chip includes a 32-bit ARM7TDMI RISC processor and 256KB of SRAM.

The CO2064SEC peripheral set includes a USB V2.0 full-speed host and device port; 10/100BaseT Ethernet via RMII; one USART; two SPI, and two-wire interfaces.

CO2064SEC has an internal 1.2V LDO power supply; comes in a 64-pin LQFP RoHS-compliant package, and operates in the industrial temperature range.

Key Features

- Complete Internet Protocol stack
- 3DES, SHA-1/256, AES-128/192/256, and SSL3/TLS1 encryption suites
- UDP acceleration in hardware
- Numerous communication interfaces
- Serial-to-IP bridging in SerialNET mode

Internet Protocols

- IP, UDP, TCP, PING, DNS, NTP, SSL3/TLS1, SMTP, FTP and HTTP clients
- LAN protocols: ARP, ICMP, DHCP

Application Program Interface

Connect One's AT+i protocol eliminates the need for Internet programming and minimizes changes to the host application. AT+i commands are used to configure parameters and execute Internet- or Ethernet-based connectivity tasks such as manipulating sockets, sending e-mail, or managing an FTP session without any prior knowledge in connectivity or security programming.

Hardware Description

- Package: 64-pin LQFP, RoHS-compliant
- Dimensions: 10x10x1.4mm, 0.5mm pitch
- Core CPU: 32-bit RISC ARM7TDMI, 0.13 micron, low-leakage
- I/O Operating Range: 3.3V+/-10%
- Core Operating Range: 1.2V+/-10%
- Operating Frequency: Up to 48MHz
- Operating Humidity: 90% max. (non-condensing)
- Operating Temperature Range: -40° to 85°C (-40° to 185°F)
- Power Consumption with external VDD Core @ 1.2V: 200mW (typical)
- Interfaces: USART, two-wire, two SPIs, USB V2.0 host and device

Block Diagram

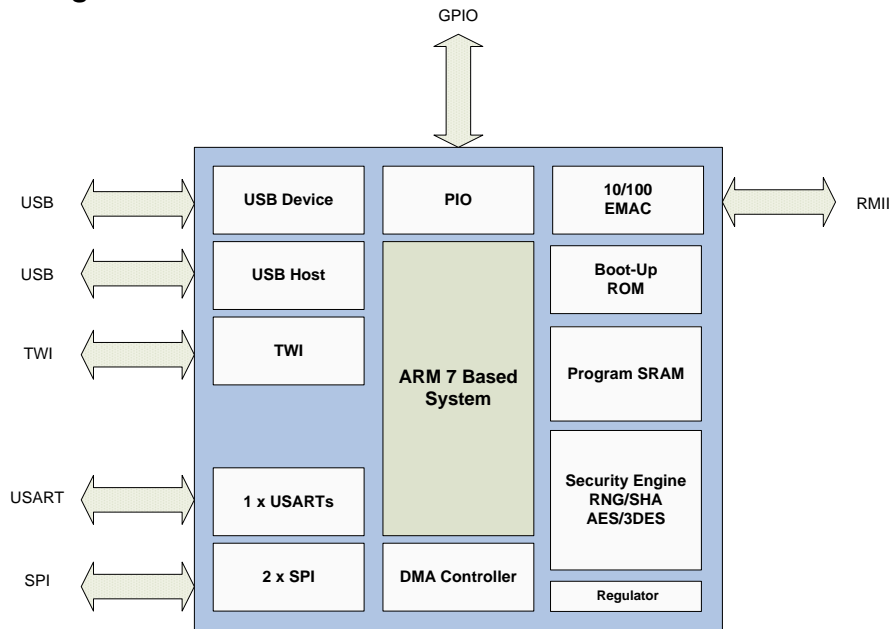

Mechanical Views

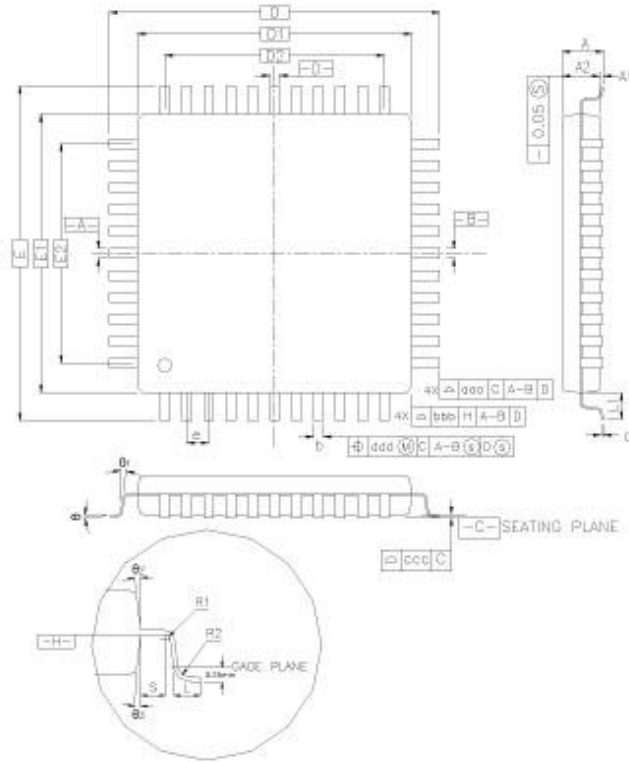

CONTROL DIMENSIONS ARE IN MILLIMETERS.

SYMBOL	MILLIMETER			INCH		
	MIN.	NOM.	MAX.	MIN.	NOM.	MAX.
A	—	—	1.60	—	—	0.063
A1	0.05	—	0.15	0.002	—	0.006
A2	1.35	1.40	1.45	0.053	0.055	0.057
D	12.00 BSC.	—	—	0.472 BSC.	—	—
D1	10.00 BSC.	—	—	0.393 BSC.	—	—
E	12.00 BSC.	—	—	0.472 BSC.	—	—
E1	10.00 BSC.	—	—	0.393 BSC.	—	—
R2	0.08	—	0.20	0.003	—	0.008
R1	0.08	—	—	0.003	—	—
θ	0°	3.5°	7°	0°	3.6°	7°
θ1	0°	—	—	0°	—	—
θ2	11°	12°	13°	11°	12°	13°
θ3	11°	12°	13°	11°	12°	13°
c	0.09	—	0.20	0.004	—	0.008
L	0.45	0.60	0.75	0.018	0.024	0.030
L1	1.00 REF.	—	—	0.039 REF.	—	—
S	0.20	—	—	0.008	—	—
b	0.17	0.20	0.27	0.007	0.008	0.011
e	0.50 BSC.	—	—	0.020 BSC.	—	—
D1	7.50	—	—	0.295	—	—
E1	7.50	—	—	0.295	—	—
TOLERANCES OF FORM AND POSITION						
aaa	0.20	—	—	0.008	—	—
bbb	0.20	—	—	0.008	—	—
ccc	0.08	—	—	0.003	—	—
ddd	0.08	—	—	0.003	—	—

Pin-Out

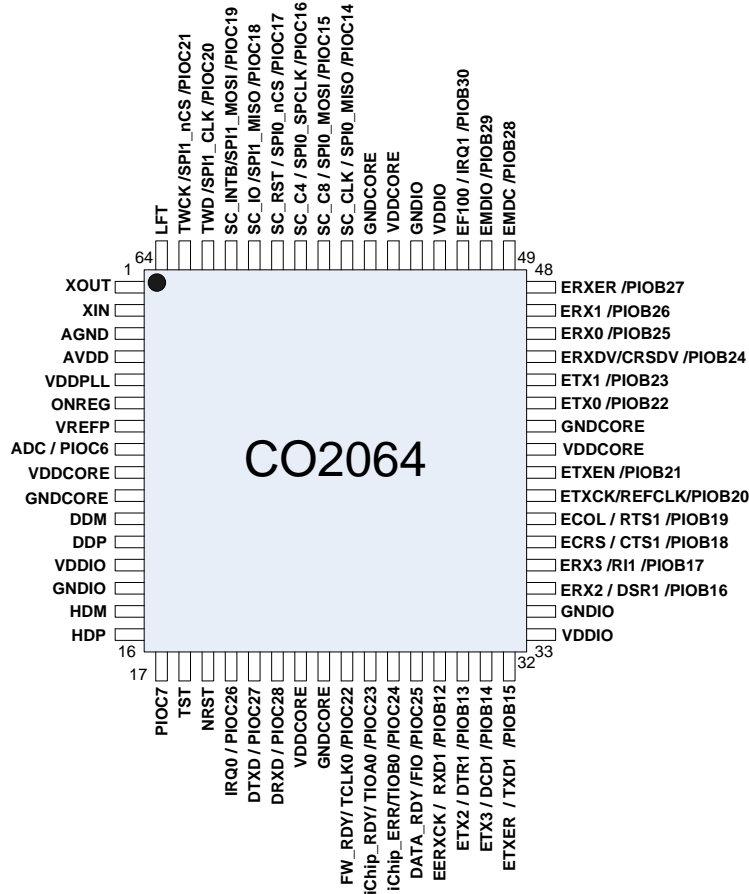

Ordering Information:

CO2064-48LI-3	iChip CO2064SEC
CO2064-48LI-3(SP)	iChip CO2064SEC Sample Package (2 chips)
II-EVB-600-3-110	Evaluation board for the iChip CO2064SEC, 110V
II-EVB-600-3-220	Evaluation board for the iChip CO2064SEC, 220V

iChip, AT+i, SerialNET, and Connect One are trademarks of Connect One Ltd.
Specifications are subject to change without notice.