

LOW SKEW, 1-TO-4 LVCMOS/LVTTL FANOUT BUFFER

ICS8304

GENERAL DESCRIPTION

The ICS8304 is a low skew, 1-to-4 Fanout Buffer. The ICS8304 is characterized at full 3.3V for input (V_{DD}), and mixed 3.3V and 2.5V for output operating supply modes (V_{DDO}). Guaranteed output and part-to-part skew characteristics make the ICS8304 ideal for those clock distribution applications demanding well defined performance and repeatability.

FEATURES

- Four LVCMOS / LVTTTL outputs
- LVCMOS / LVTTTL clock input
- CLK can accept the following input levels: LVCMOS, LVTTTL
- Maximum output frequency: 200MHz
- Additive phase jitter, RMS: 0.173ps (typical) @ 3.3V
- Output skew: 45ps (maximum) @ 3.3V
- Part-to-part skew: 500ps (maximum)
- Small 8 lead SOIC package saves board space
- 3.3V input, outputs may be either 3.3V or 2.5V supply modes
- 0°C to 70°C ambient operating temperature
- Available in both standard (RoHS 5) and lead-free (RoHS 6) compliant packages

BLOCK DIAGRAM

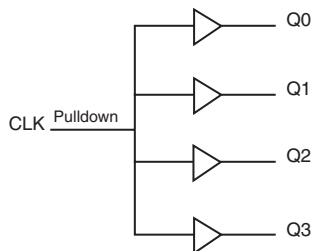

PIN ASSIGNMENT

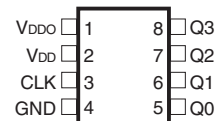

ICS8304
8-Lead SOIC

3.9mm x 4.9mm, x 1.375mm package body

M Package
Top View

TABLE 1. PIN DESCRIPTIONS

Number	Name	Type		Description
1	V _{DDO}	Power		Output supply pin.
2	V _{DD}	Power		Positive supply pin.
3	CLK	Input	Pulldown	LVCMOS / LVTTL clock input.
4	GND	Power		Power supply ground.
5	Q0	Output		Single clock output. LVCMOS / LVTTL interface levels.
6	Q1	Output		Single clock output. LVCMOS / LVTTL interface levels.
7	Q2	Output		Single clock output. LVCMOS / LVTTL interface levels.
8	Q3	Output		Single clock output. LVCMOS / LVTTL interface levels.

NOTE: *Pulldown* refers to internal input resistors. See Table 2, Pin Characteristics, for typical values.

TABLE 2. PIN CHARACTERISTICS

Symbol	Parameter	Test Conditions	Minimum	Typical	Maximum	Units
C _{IN}	Input Capacitance			4		pF
C _{PD}	Power Dissipation Capacitance (per output)	V _{DD} , V _{DDO} = 3.465V			15	pF
R _{PULLDOWN}	Input Pulldown Resistor			51		kΩ
R _{OUT}	Output Impedance		5	7	12	Ω

ABSOLUTE MAXIMUM RATINGS

Supply Voltage, V_{DD}	4.6V
Inputs, V_I	-0.5V to $V_{DD} + 0.5V$
Outputs, V_O	-0.5V to $V_{DDO} + 0.5V$
Package Thermal Impedance, θ_{JA}	112.7°C/W (0 lfpm)
Storage Temperature, T_{STG}	-65°C to 150°C

NOTE: Stresses beyond those listed under Absolute Maximum Ratings may cause permanent damage to the device. These ratings are stress specifications only. Functional operation of product at these conditions or any conditions beyond those listed in the *DC Characteristics* or *AC Characteristics* is not implied. Exposure to absolute maximum rating conditions for extended periods may affect product reliability.

TABLE 3A. POWER SUPPLY DC CHARACTERISTICS, $V_{DD} = V_{DDO} = 3.3V \pm 5\%$, $T_A = 0^\circ\text{C}$ TO 70°C

Symbol	Parameter	Test Conditions	Minimum	Typical	Maximum	Units
V_{DD}	Power Supply Voltage		3.135	3.3	3.465	V
V_{DDO}	Output Power Supply Voltage		3.135	3.3	3.465	V
I_{DD}	Power Supply Current				15	mA
I_{DDO}	Output Supply Current				8	mA

TABLE 3B. POWER SUPPLY DC CHARACTERISTICS, $V_{DD} = 3.3V \pm 5\%$, $V_{DDO} = 2.5V \pm 5\%$, $T_A = 0^\circ\text{C}$ TO 70°C

Symbol	Parameter	Test Conditions	Minimum	Typical	Maximum	Units
V_{DD}	Positive Supply Voltage		3.135	3.3	3.465	V
V_{DDO}	Output Supply Voltage		2.375	2.5	2.625	V
I_{DD}	Power Supply Current				15	mA
I_{DDO}	Output Supply Current				8	mA

TABLE 3C. LVCMOS / LVTTL DC CHARACTERISTICS, $V_{DD} = V_{DDO} = 3.3V \pm 5\%$, $T_A = 0^\circ\text{C}$ TO 70°C

Symbol	Parameter	Test Conditions	Minimum	Typical	Maximum	Units
V_{IH}	Input High Voltage		2		$V_{DD} + 0.3$	V
V_{IL}	Input Low Voltage		-0.3		1.3	V
I_{IH}	Input High Current	$V_{DD} = V_{IN} = 3.465V$			150	μA
I_{IL}	Input Low Current	$V_{DD} = 3.465V, V_{IN} = 0V$	-5			μA
V_{OH}	Output High Voltage	Refer to NOTE 1	2.6			V
		$I_{OH} = -16\text{mA}$	2.9			V
		$I_{OH} = -100\mu\text{A}$	3			V
V_{OL}	Output Low Voltage	Refer to NOTE 1			0.5	V
		$I_{OL} = 16\text{mA}$			0.25	V
		$I_{OL} = 100\mu\text{A}$			0.15	V

NOTE 1: Outputs terminated with 50Ω to $V_{DDO}/2$. See Parameter Measurement Section, "3.3V Output Load Test Circuit".

TABLE 3D. LVCMOS / LVTTL DC CHARACTERISTICS, $V_{DD} = 3.3V \pm 5\%$, $V_{DDO} = 2.5V \pm 5\%$, $T_A = 0^\circ C$ TO $70^\circ C$

Symbol	Parameter	Test Conditions	Minimum	Typical	Maximum	Units
V_{IH}	Input High Voltage		2		$V_{DD} + 0.3$	V
V_{IL}	Input Low Voltage		-0.3		1.3	V
I_{IH}	Input High Current	$V_{DD} = V_{IN} = 3.465V$			150	μA
I_{IL}	Input Low Current	$V_{DD} = 3.465V, V_{IN} = 0V$	-5			μA
V_{OH}	Output High Voltage; NOTE 1		2.1			V
V_{OL}	Output Low Voltage; NOTE 1				0.5	V

NOTE 1: Outputs terminated with 50Ω to $V_{DDO}/2$. See Parameter Measurement Section, "3.3V/2.5V Output Load Test Circuit".

TABLE 4A. AC CHARACTERISTICS, $V_{DD} = V_{DDO} = 3.3V \pm 5\%$, $T_A = 0^\circ C$ TO $70^\circ C$

Symbol	Parameter	Test Conditions	Minimum	Typical	Maximum	Units
f_{MAX}	Maximum Output Frequency				200	MHz
t_{pLH}	Propagation Delay, Low-to-High; NOTE 1	$f \leq 166MHz$	2.0		3.3	ns
		$166MHz < f \leq 189.5MHz$	2.0		3.4	ns
t_{jit}	Buffer Additive Phase Jitter, RMS; refer to Additive Phase Jitter Section	125MHz, Integration Range: 12kHz – 20MHz		0.173		ps
$t_{sk(o)}$	Output Skew; NOTE 2, 4	$f = 133MHz$			45	ps
$t_{sk(pp)}$	Part-to-Part Skew; NOTE 3, 4				500	ps
t_R	Output Rise Time	30% to 70%	250		500	ps
t_F	Output Fall Time	30% to 70%	250		500	ps
odc	Output Duty Cycle	$f \leq 189.5MHz$	40		60	%

All parameters measured at f_{MAX} unless noted otherwise.

NOTE 1: Measured from $V_{DD}/2$ of the input to $V_{DDO}/2$ of the output.

NOTE 2: Defined as skew between outputs at the same supply voltage and with equal load conditions. Measured at $V_{DDO}/2$.

NOTE 3: Defined as skew between outputs on different devices operating at the same supply voltages and with equal load conditions. Using the same type of inputs on each device, the outputs are measured at $V_{DDO}/2$.

NOTE 4: This parameter is defined in accordance with JEDEC Standard 65.

TABLE 4B. AC CHARACTERISTICS, $V_{DD} = 3.3V \pm 5\%$, $V_{DDO} = 2.5V \pm 5\%$, $T_A = 0^\circ C$ TO $70^\circ C$

Symbol	Parameter	Test Conditions	Minimum	Typical	Maximum	Units
f_{MAX}	Maximum Output Frequency				189.5	MHz
t_{pLH}	Propagation Delay, Low-to-High; NOTE 1	$f \leq 166MHz$	2.3		3.7	ns
		$166MHz < f \leq 189.5MHz$	2.15		3.55	ns
$t_{sk(o)}$	Output Skew; NOTE 2, 4	$f = 133MHz$			60	ps
$t_{sk(pp)}$	Part-to-Part Skew; NOTE 3, 4				500	ps
t_R	Output Rise Time	30% to 70%	250		500	ps
t_F	Output Fall Time	30% to 70%	250		500	ps
odc	Output Duty Cycle	$f \leq 189.5MHz$	40		60	%

For NOTES, please see above Table 4A.

ADDITIVE PHASE JITTER

The spectral purity in a band at a specific offset from the fundamental compared to the power of the fundamental is called the ***dBc Phase Noise***. This value is normally expressed using a Phase noise plot and is most often the specified plot in many applications. Phase noise is defined as the ratio of the noise power present in a 1Hz band at a specified offset from the fundamental frequency to the power value of the fundamental. This ratio is expressed in decibels (dBm) or a ratio of the power in the 1Hz

band to the power in the fundamental. When the required offset is specified, the phase noise is called a ***dBc*** value, which simply means dBm at a specified offset from the fundamental. By investigating jitter in the frequency domain, we get a better understanding of its effects on the desired application over the entire time record of the signal. It is mathematically possible to calculate an expected bit error rate given a phase noise plot.

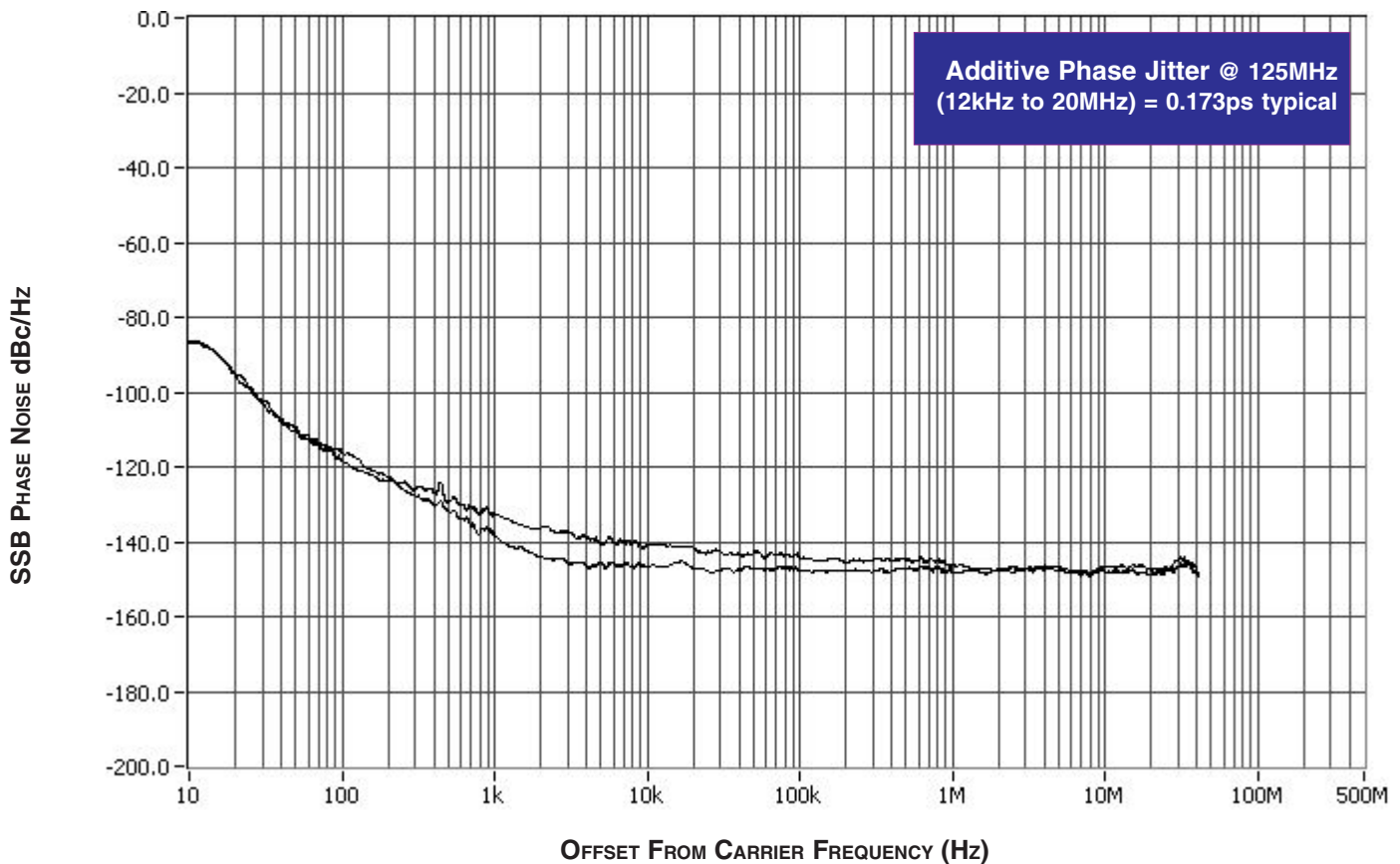

As with most timing specifications, phase noise measurements has issues. The primary issue relates to the limitations of the equipment. Often the noise floor of the equipment is higher than the noise floor of the device. This is illustrated above. The device

meets the noise floor of what is shown, but can actually be lower. The phase noise is dependant on the input source and measurement equipment.

PARAMETER MEASUREMENT INFORMATION

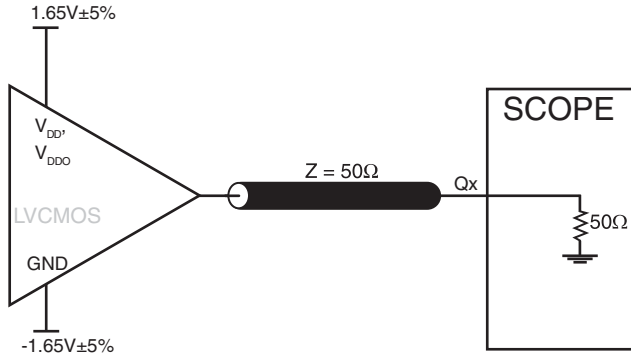

3.3V OUTPUT LOAD AC TEST CIRCUIT

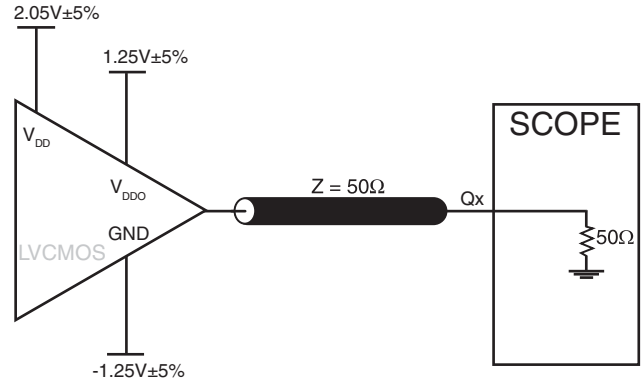

2.5V OUTPUT LOAD AC TEST CIRCUIT

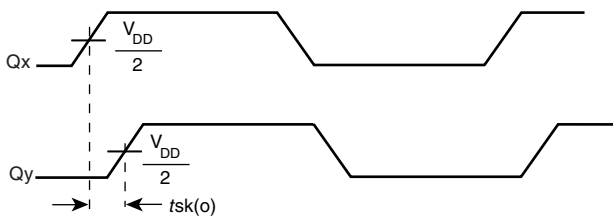

OUTPUT SKEW

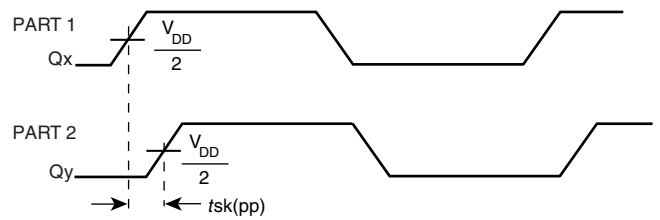

PART-TO-PART SKEW

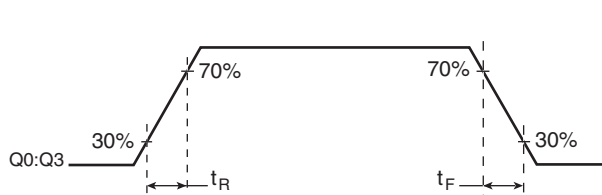

OUTPUT RISE/FALL TIME

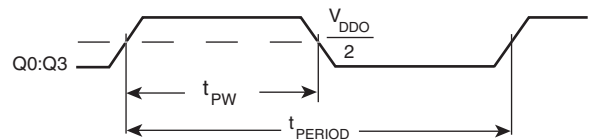

$$odc = \frac{t_{PW}}{t_{PERIOD}} \times 100\%$$

OUTPUT DUTY CYCLE/PULSE WIDTH/PERIOD

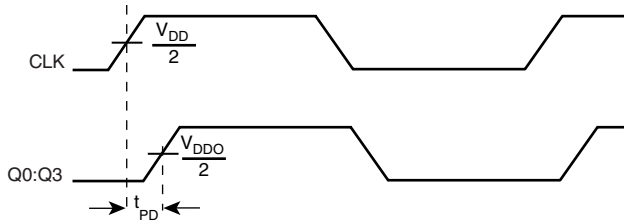

PROPAGATION DELAY

APPLICATION INFORMATION

RECOMMENDATIONS FOR UNUSED OUTPUT PINS

OUTPUTS:

LVCMOS OUTPUT:

All unused LVCMOS output can be left floating. There should be no trace attached.

RELIABILITY INFORMATION

TABLE 5. θ_{JA} vs. AIR FLOW TABLE

	θ_{JA} by Velocity (Linear Feet per Minute)		
	0	200	500
Single-Layer PCB, JEDEC Standard Test Boards	153.3°C/W	128.5°C/W	115.5°C/W
Multi-Layer PCB, JEDEC Standard Test Boards	112.7°C/W	103.3°C/W	97.1°C/W

NOTE: Most modern PCB designs use multi-layered boards. The data in the second row pertains to most designs.

TRANSISTOR COUNT

The transistor count for ICS8304 is: 416

PACKAGE OUTLINE - SUFFIX M FOR 8 LEAD SOIC

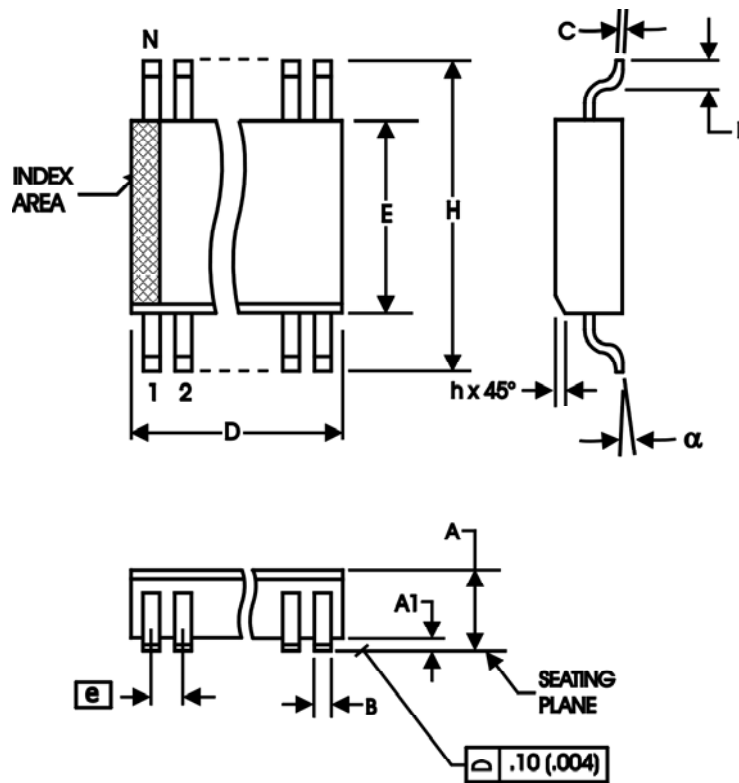

TABLE 6. PACKAGE DIMENSIONS - SUFFIX M

SYMBOL	Millimeters	
	MINIMUM	MAXIMUM
N	8	
A	1.35	1.75
A1	0.10	0.25
B	0.33	0.51
C	0.19	0.25
D	4.80	5.00
E	3.80	4.00
e	1.27 BASIC	
H	5.80	6.20
h	0.25	0.50
L	0.40	1.27
α	0°	8°

Reference Document: JEDEC Publication 95, MS-012

TABLE 7. ORDERING INFORMATION

Part/Order Number	Marking	Package	Shipping Packaging	Temperature
8304AM	8304AM	8 lead SOIC	Tube	0°C to 70°C
8304AMT	8304AM	8 lead SOIC	2500 Tape and Reel	0°C to 70°C
8304AMLN	8304AMLN	8 lead SOIC, Lead Free/Annealed	Tube	0°C to 70°C
8304AMLNT	8304AMLN	8 lead SOIC, Lead Free/Annealed	2500 Tape and Reel	0°C to 70°C
8304AMLF	8304AMLF	8 lead SOIC, Lead Free	Tube	0°C to 70°C
8304AMLFT	8304AMLF	8 lead SOIC, Lead Free	2500 Tape and Reel	0°C to 70°C

NOTE: Parts that are ordered with an "LF" suffix to the part number are the Pb-Free configuration and are RoHS compliant.

While the information presented herein has been checked for both accuracy and reliability, Integrated Device Technology, Incorporated (IDT) assumes no responsibility for either its use or for infringement of any patents or other rights of third parties, which would result from its use. No other circuits, patents, or licenses are implied. This product is intended for use in normal commercial applications. Any other applications such as those requiring extended temperature ranges, high reliability or other extraordinary environmental requirements are not recommended without additional processing by IDT. IDT reserves the right to change any circuitry or specifications without notice. IDT does not authorize or warrant any IDT product for use in life support devices or critical medical instruments.

REVISION HISTORY SHEET

Rev	Table	Page	Description of Change	Date
B	T4A	3	<ul style="list-style-type: none"> Revised tp_{LH} (Propagation Delay) row from 2.3 Min. to 2 Min. Deleted tp_{HL} row. Revised $tsk(o)$ (Output Skew) row from 35 Max. to 80 Max. Revised $tsk(pp)$ (Part-to-Part Skew) row from 200 Max. to 500 Max. General note changed from "...measured at 166MHz..." to "...measured at 150MHz..." 	12/4/01
	T4B	4	<ul style="list-style-type: none"> Revised tp_{LH} (Propagation Delay) row from 2.6 Min. to 2.3 Min. Deleted tp_{HL} row. Revised $tsk(o)$ (Output Skew) row from 35 Max. to 85 Max. Revised $tsk(pp)$ (Part-to-Part Skew) row from 200 Max. to 500 Max. General note changed from "...measured at 166MHz..." to "...measured at 150MHz..." 	
C	T4A	3	<ul style="list-style-type: none"> In AC table, revised $tsk(o)$ row from 80ps Max. to 45ps Max. Added $f = 133\text{MHz}$ in Test Conditions column. In odc row, deleted test conditions. In notes, changed 150MHz to f_{MAX}. 	12/11/01
	T4B	4	<ul style="list-style-type: none"> In AC table, revised $tsk(o)$ row from 80ps Max. to 60ps Max. Added $f = 133\text{MHz}$ in Test Conditions column. In odc row, deleted test conditions In notes, changed 150MHz to f_{MAX}. 	
C	T7	10	In the Ordering Information table, Marking column, revised marking to read 8304AM from ICS8304AM.	3/11/02
D	T3B	3	LVCMOS/LVTTL DC Characteristics Table, added I_{OH} and I_{OL} Test Conditions to V_{OH} and V_{OL} rows.	4/4/02
E	T1	1	Pin Assignment - adjusted dimensions.	4/13/04
	T2	2	Pin Descriptions - changed V_{DD} description to Core supply pin.	
	T3A & T3C	2	Pin Characteristics - changed C_{IN} max 4pF to typical 4pF.	
E	T7	3 & 4	Deleted R_{PULLUP} row. Added 5 Ω min. and 12 Ω max. to R_{OUT} .	8
	T7	8	<ul style="list-style-type: none"> Power Supply tables - changed V_{DD} parameter from Power to Core. Ordering Information table - added "Lead Free/Annealed" marking. Updated format throughout the data sheet.	
F	T4A	1	Features section, changed Maximum output frequency bullet from 166MHz to 200MHz.	6/1/04
	T4A	4	3.3V AC Table - changed 166MHz max. to 200MHz max. Added another line for Propagation Delay. Changed test conditions in Output Duty Cycle from 166MHz to 189.5MHz.	
	T4B	4	3.3V AC Table - changed 166MHz max. to 189.5MHz max. Added another line for Propagation Delay. Changed test conditions in Output Duty Cycle from 166MHz to 189.5MH	
F	T7	8	Ordering Information table - added "Lead Free" marking.	9/13/04
G	T4A	1	Features Section - added <i>Additive Phase Jitter</i> bullet.	6/11/07
		4	3.3V AC Characteristics Table - added <i>Additive Phase Jitter</i> row.	
		5	Added <i>Additive Phase Jitter</i> plot.	
		7	Added <i>Recommendations for Unused Output Pins</i> .	
H		1	Pin Assignment - corrected "pullup" label to "pulldown" label.	10/29/10

Innovate with IDT and accelerate your future networks. Contact:

www.IDT.com

For Sales

800-345-7015
408-284-8200
Fax: 408-284-2775

For Tech Support

netcom@idt.com
480-763-2056

Corporate Headquarters

Integrated Device Technology, Inc.
6024 Silver Creek Valley Road
San Jose, CA 95138
United States
800 345 7015
+408 284 8200 (outside U.S.)

Asia Pacific and Japan

Integrated Device Technology
Singapore (1997) Pte. Ltd.
Reg. No. 199707558G
435 Orchard Road
#20-03 Wisma Atria
Singapore 238877
+65 6 887 5505

Europe

IDT Europe, Limited
321 Kingston Road
Leatherhead, Surrey
KT22 7TU
England
+44 (0) 1372 363 339
Fax: +44 (0) 1372 378851



www.IDT.com