

## N-Channel JFETs

<b>J108</b>	<b>SST108</b>
<b>J109</b>	<b>SST109</b>
<b>J110</b>	<b>SST110</b>

PRODUCT SUMMARY				
Part Number	V <sub>GS(off)</sub> (V)	r <sub>DS(on)</sub> Max (Ω)	I <sub>D(off)</sub> Typ (pA)	t <sub>ON</sub> Typ (ns)
J/SST108	-3 to -10	8	20	4
J/SST109	-2 to -6	12	20	4
J/SST110	-0.5 to -4	18	20	4

### FEATURES

- Low On-Resistance: J108 <8 Ω
- Fast Switching—t<sub>ON</sub>: 4 ns
- Low Leakage: 20 pA
- Low Capacitance: 11 pF
- Low Insertion Loss

### BENEFITS

- Low Error Voltage
- High-Speed Analog Circuit Performance
- Negligible “Off-Error” Excellent Accuracy
- Good Frequency Response
- Eliminates Additional Buffering

### APPLICATIONS

- Analog Switches
- Choppers
- Sample-and-Hold
- Normally “On” Switches
- Current Limiters

### DESCRIPTION

The J/SST108 series is designed with high-performance analog switching applications in mind. It features low on-resistance, good off-isolation, and fast switching.

The SST108 series is comprised of surface-mount devices featuring the lowest r<sub>DS(on)</sub> of any TO-236 (SOT-23) JFET device.

The TO-226AA (TO-92) plastic package provides a low-cost option. Both the J and SST series are available in tape-and-reel for automated assembly (see Packaging Information). For similar products packaged in TO-206AC (TO-52), see the 2N5432/5433/5434 data sheet.

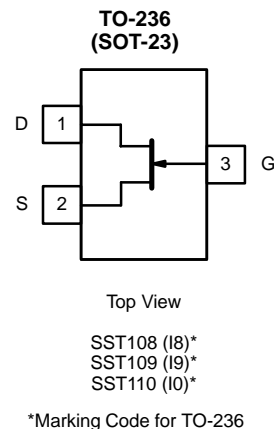
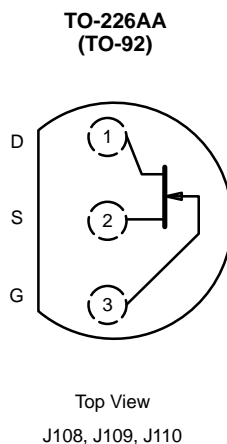



### ABSOLUTE MAXIMUM RATINGS

Gate-Drain, Gate-Source Voltage ..... -25 V  
 Gate Current ..... 50 mA  
 Lead Temperature ( $1/16''$  from case for 10 sec.) ..... 300°C  
 Storage Temperature ..... -55 to 150°C

Operating Junction Temperature ..... -55 to 150°C  
 Power Dissipation<sup>a</sup> ..... 350 mW

#### Notes

a. Derate 2.8 mW/°C above 25°C

SPECIFICATIONS ( $T_A = 25^\circ\text{C}$ UNLESS OTHERWISE NOTED)										
Parameter	Symbol	Test Conditions	Typ <sup>a</sup>	Limits						Unit
				J/SST108		J/SST109		J/SST110		
				Min	Max	Min	Max	Min	Max	
<b>Static</b>										
Gate-Source Breakdown Voltage	$V_{(BR)GSS}$	$I_G = -1 \mu\text{A}, V_{DS} = 0 \text{V}$	-32	-25		-25		-25		V
Gate-Source Cutoff Voltage	$V_{GS(off)}$	$V_{DS} = 5 \text{V}, I_D = 1 \mu\text{A}$		-3	-10	-2	-6	-0.5	-4	
Saturation Drain Current <sup>b</sup>	$I_{DSS}$	$V_{DS} = 15 \text{V}, V_{GS} = 0 \text{V}$		80		40		10		mA
Gate Reverse Current	$I_{GSS}$	$V_{GS} = -15 \text{V}, V_{DS} = 0 \text{V}$	-0.01		-3		-3		-3	nA
Gate Operating Current	$I_G$	$V_{DG} = 10 \text{V}, I_D = 10 \text{mA}$	-0.01							
Drain Cutoff Current	$I_{D(off)}$	$V_{DS} = 5 \text{V}, V_{GS} = -10 \text{V}$	0.02		3		3		3	
Drain-Source On-Resistance	$r_{DS(on)}$	$V_{GS} = 0 \text{V}, V_{DS} \leq 0.1 \text{V}$			8		12		18	$\Omega$
Gate-Source Forward Voltage	$V_{GS(F)}$	$I_G = 1 \text{mA}, V_{DS} = 0 \text{V}$	0.7							V
<b>Dynamic</b>										
Common-Source Forward Transconductance	$g_{fs}$	$V_{DS} = 5 \text{V}, I_D = 10 \text{mA}, f = 1 \text{kHz}$	17							mS
Common-Source Output Conductance	$g_{os}$		0.6							
Drain-Source On-Resistance	$r_{ds(on)}$	$V_{GS} = 0 \text{V}, I_D = 0 \text{mA}, f = 1 \text{kHz}$			8		12		18	$\Omega$
Common-Source Input Capacitance	$C_{iss}$	$V_{DS} = 0 \text{V}$ $V_{GS} = 0 \text{V}$ $f = 1 \text{MHz}$	SST	60						pF
			J Series	60		85		85		
Common-Source Reverse Transfer Capacitance	$C_{rss}$	$V_{DS} = 0 \text{V}$ $V_{GS} = -10 \text{V}$ $f = 1 \text{MHz}$	SST	11						
			J Series	11		15		15		
Equivalent Input Noise Voltage	$\bar{e}_n$	$V_{DG} = 5 \text{V}, I_D = 10 \text{mA}$ $f = 1 \text{kHz}$	3.5							nV/ $\sqrt{\text{Hz}}$
<b>Switching</b>										
Turn-On Time	$t_{d(on)}$	$V_{DD} = 1.5 \text{V}, V_{GS(H)} = 0 \text{V}$ See Switching Diagram	3							ns
	$t_r$		1							
Turn-Off Time	$t_{d(off)}$		4							
	$t_f$		18							

#### Notes

- a. Typical values are for DESIGN AID ONLY, not guaranteed nor subject to production testing.  
 b. Pulse test:  $PW \leq 300 \mu\text{s}$  duty cycle  $\leq 3\%$ .

NIP



**TYPICAL CHARACTERISTICS (T<sub>A</sub> = 25°C UNLESS OTHERWISE NOTED)**

**On-Resistance and Drain Current vs. Gate-Source Cutoff Voltage**

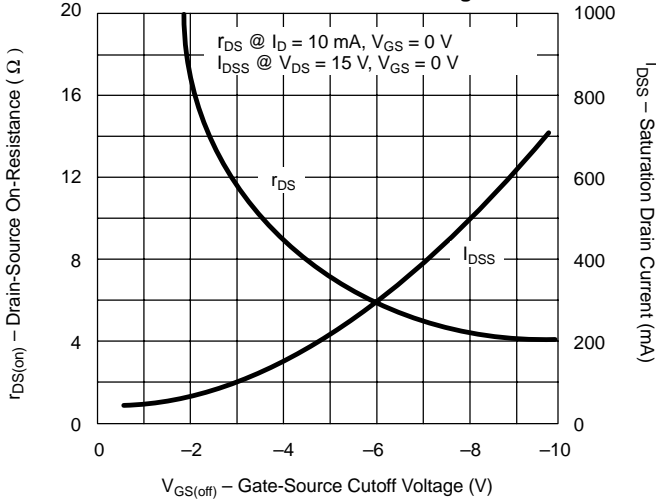

**On-Resistance vs. Drain Current**

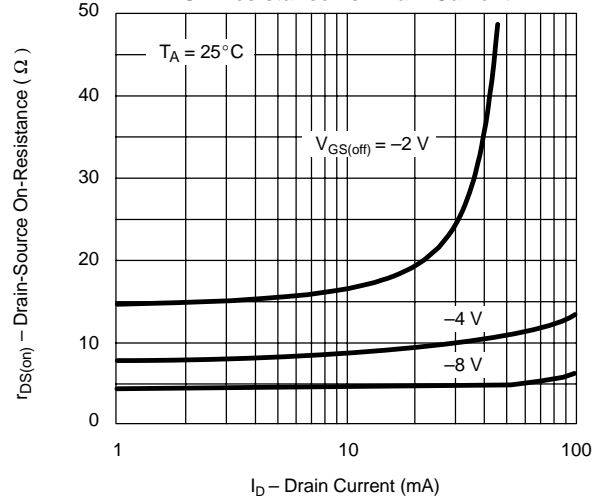

**On-Resistance vs. Temperature**

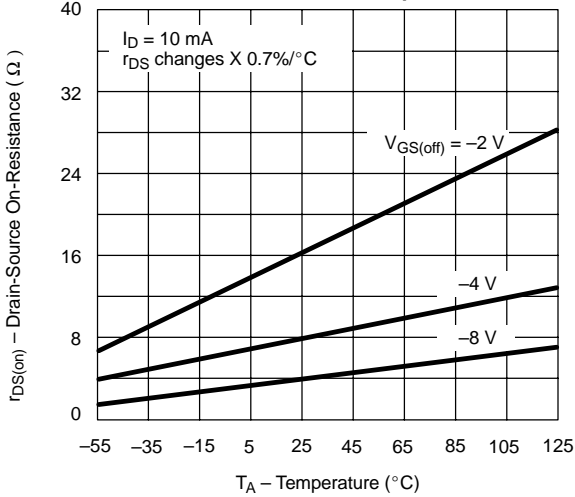

**Output Characteristics**

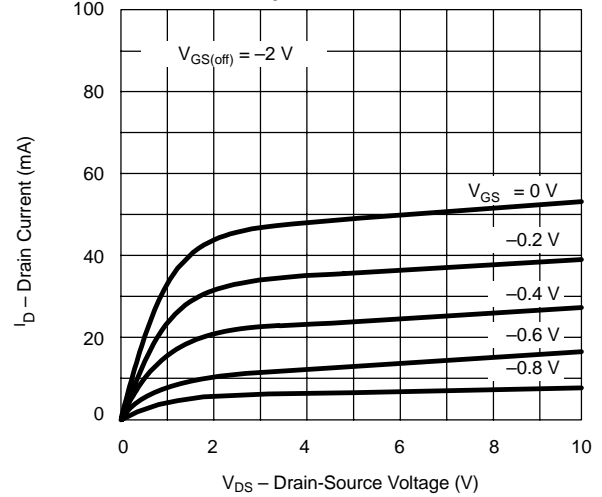

**Turn-On Switching**

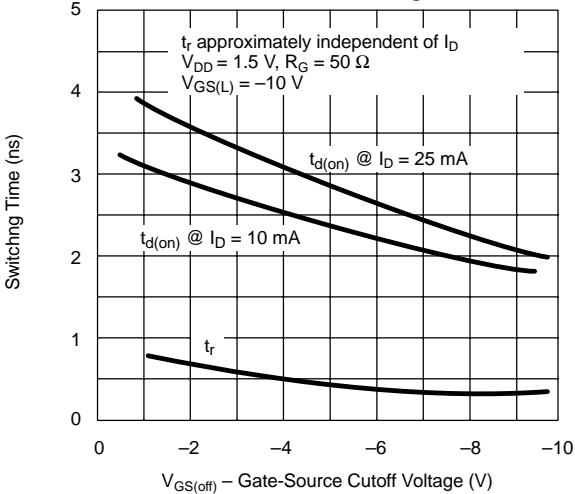

**Turn-Off Switching**

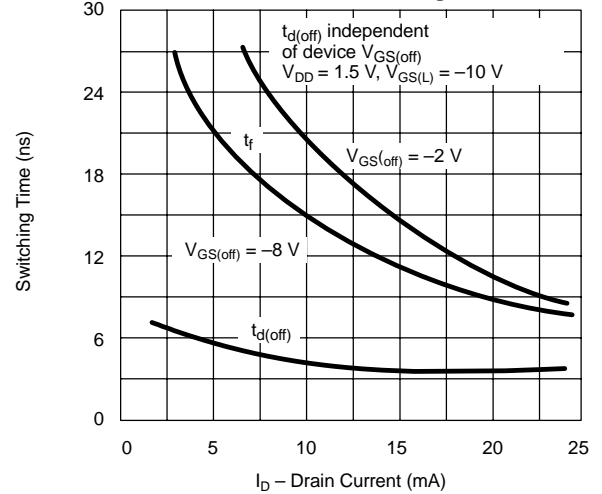

### TYPICAL CHARACTERISTICS ( $T_A = 25^\circ\text{C}$ UNLESS OTHERWISE NOTED)

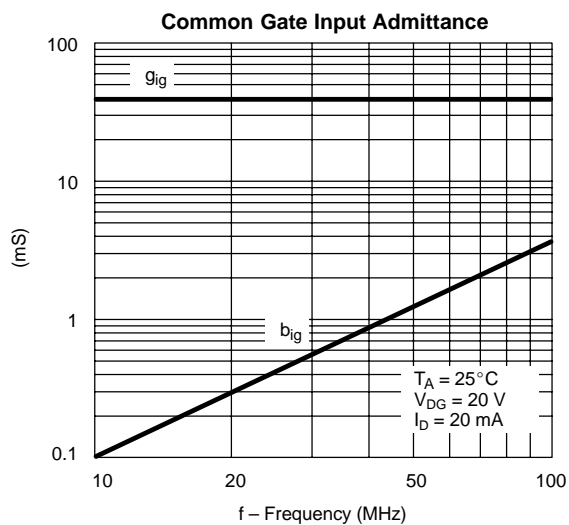
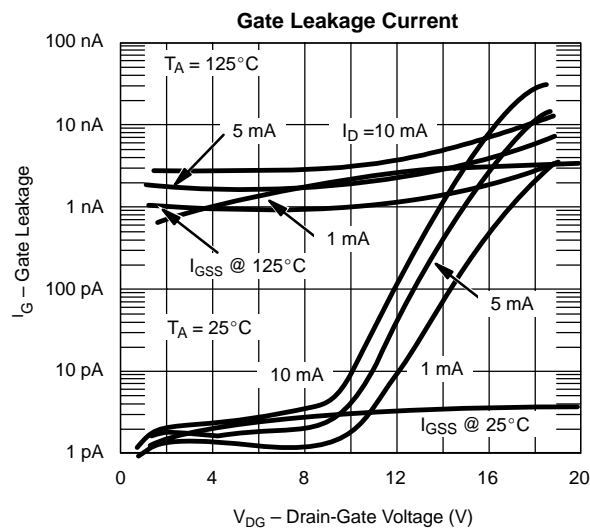
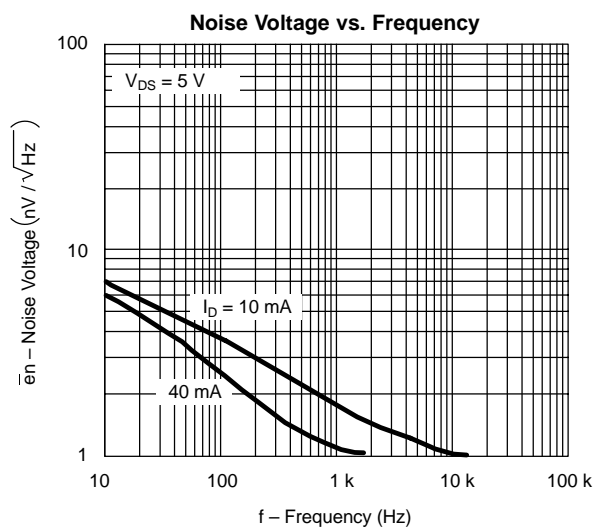
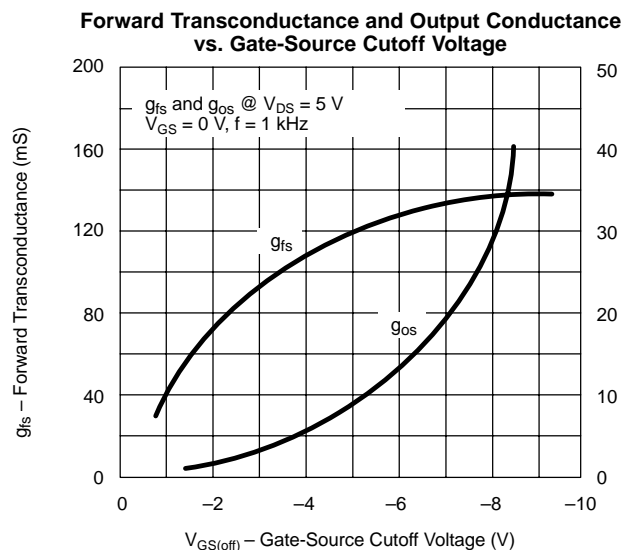
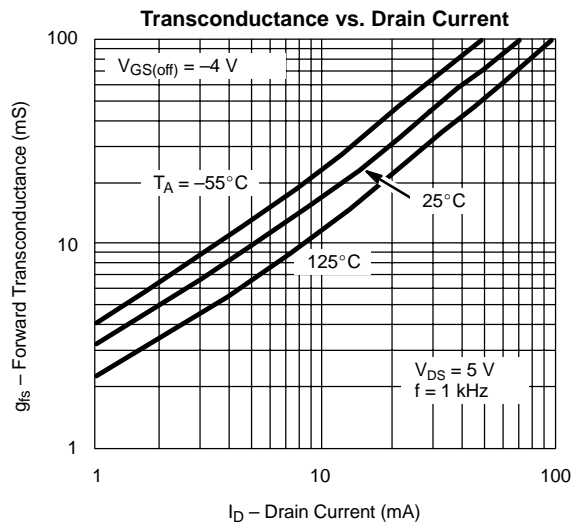
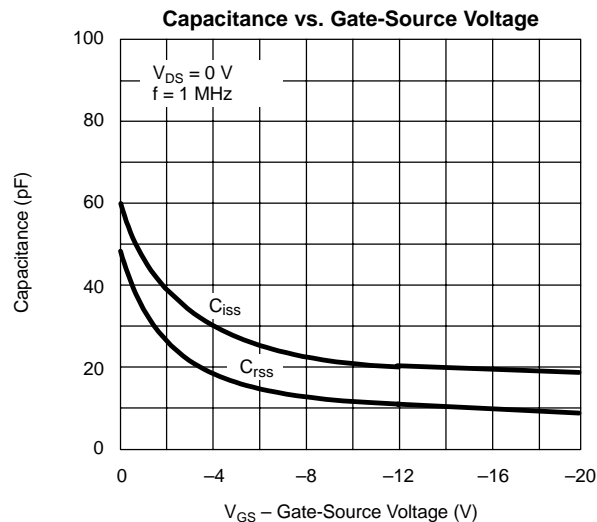

**TYPICAL CHARACTERISTICS (T<sub>A</sub> = 25°C UNLESS OTHERWISE NOTED)**

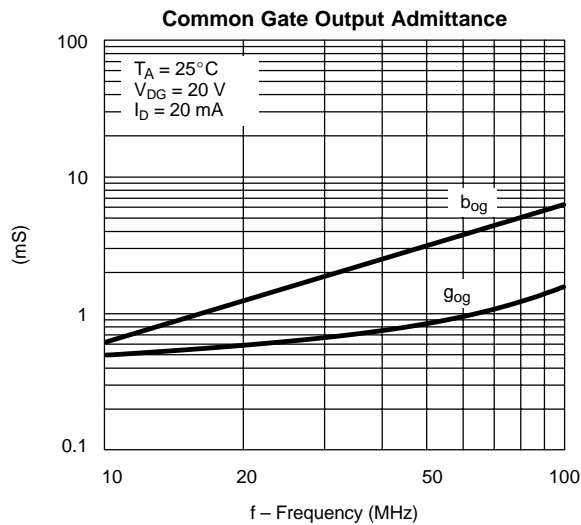
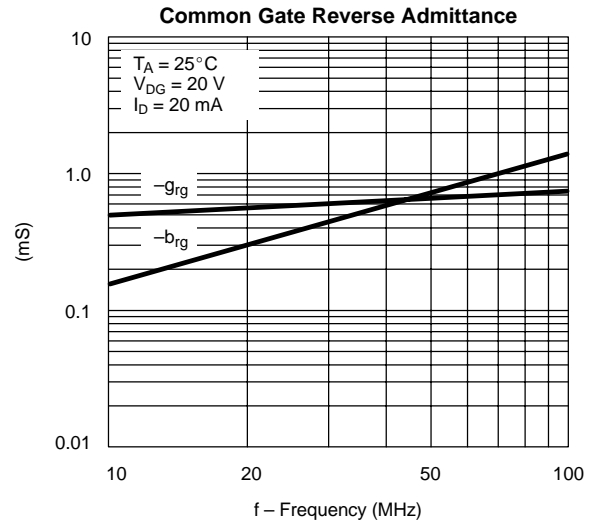
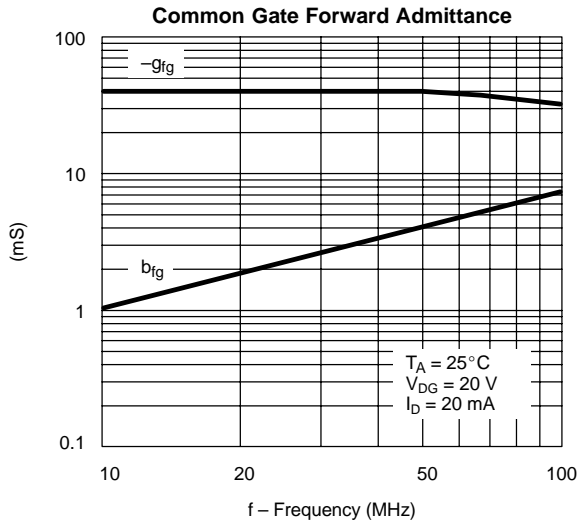

SWITCHING TIME TEST CIRCUIT			
	J/SST108	J/SST109	J/SST110
V <sub>GS(L)</sub>	-12 V	-7 V	-5 V
R <sub>L</sub> *	150 Ω	150 Ω	150 Ω
I <sub>D(on)</sub>	10 mA	10 mA	10 mA

\*Non-inductive

**INPUT PULSE**

Rise Time < 1 ns  
 Fall Time < 1 ns  
 Pulse Width 100 ns  
 PRF 1 MHz

**SAMPLING SCOPE**

Rise Time 0.4 ns  
 Input Resistance 10 MΩ  
 Input Capacitance 1.5 pF

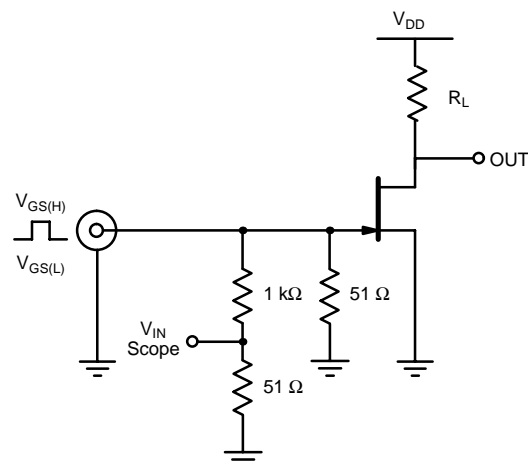



## Disclaimer

All product specifications and data are subject to change without notice.

Vishay Intertechnology, Inc., its affiliates, agents, and employees, and all persons acting on its or their behalf (collectively, "Vishay"), disclaim any and all liability for any errors, inaccuracies or incompleteness contained herein or in any other disclosure relating to any product.

Vishay disclaims any and all liability arising out of the use or application of any product described herein or of any information provided herein to the maximum extent permitted by law. The product specifications do not expand or otherwise modify Vishay's terms and conditions of purchase, including but not limited to the warranty expressed therein, which apply to these products.

No license, express or implied, by estoppel or otherwise, to any intellectual property rights is granted by this document or by any conduct of Vishay.

The products shown herein are not designed for use in medical, life-saving, or life-sustaining applications unless otherwise expressly indicated. Customers using or selling Vishay products not expressly indicated for use in such applications do so entirely at their own risk and agree to fully indemnify Vishay for any damages arising or resulting from such use or sale. Please contact authorized Vishay personnel to obtain written terms and conditions regarding products designed for such applications.

Product names and markings noted herein may be trademarks of their respective owners.