

Monolithic N-Channel JFET Duals

PRODUCT SUMMARY					
Part Number	$V_{GS(off)}$ (V)	$V_{(BR)GSS}$ Min (V)	g_{fs} Min (mS)	I_G Max (pA)	$ V_{GS1} - V_{GS2} $ Max (mV)
U421	-0.4 to -2	-40	0.3	-0.25	10
U423	-0.4 to -2	-40	0.3	-0.25	25

FEATURES

- Monolithic Design
- High Slew Rate
- Low Offset/Drift Voltage
- Low Gate Leakage: 0.2 pA
- Low Noise
- High CMRR: 102 dB

BENEFITS

- Tight Differential Match vs. Current
- Improved Op Amp Speed, Settling Time Accuracy
- Minimum Input Error/Trimming Requirement
- Insignificant Signal Loss/Error Voltage
- High System Sensitivity
- Minimum Error with Large Input Signals

APPLICATIONS

- Ultralow Input Current Differential Amps
- High-Speed Comparators
- Impedance Converters

DESCRIPTION

The U421/423 are monolithic dual n-channel JFETs designed to provide very high input impedance for differential amplification and impedance matching. Among its many unique features, this series offers operating gate current specified at -250 fA.

The hermetic TO-78 package is available with full military processing (see Military Information).

For similar products see the low-noise U/SST401 series and high-gain 2N5911/5912 data sheets.

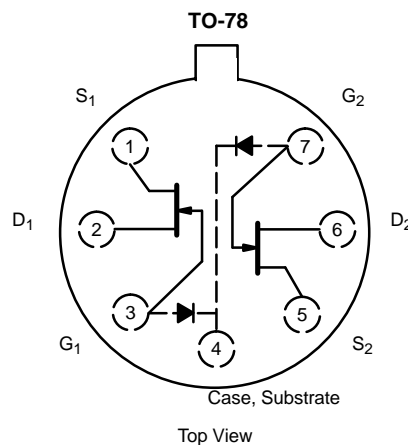

ABSOLUTE MAXIMUM RATINGS

Gate-Drain, Gate-Source Voltage -40 V
 Gate-Gate Voltage ± 40 V
 Gate Current 10 mA
 Lead Temperature ($1/16$ " from case for 10 sec.) 300 °C
 Storage Temperature -65 to 200 °C
 Operating Junction Temperature -55 to 150 °C

Power Dissipation : Per Side^a 300 mW
 Total^b 500 mW

- Notes
- a. Derate 2.4 mW/°C above 25 °C
 - b. Derate 4 mW/°C above 25 °C

SPECIFICATIONS (T _A = 25 °C UNLESS OTHERWISE NOTED)								
Parameter	Symbol	Specific Test Conditions	Typ ^a	Limits				Unit
				U421		U423		
				Min	Max	Min	Max	
Static								
Gate-Source Breakdown Voltage	V _{(BR)GSS}	I _G = -1 μA, V _{DS} = 0 V	-60	-40		-40		V
Gate-Gate Breakdown Voltage	V _{(BR)G1 - G2}	I _G = ±1 μA, I _D = 0, I _S = 0	±55	±40		±40		
Gate-Source Cutoff Voltage	V _{GS(off)}	V _{DS} = 10 V, I _D = 1 nA	-1.2	-0.4	-2	-0.4	-2	
Saturation Drain Current	I _{DSS}	V _{DS} = 10 V, V _{GS} = 0 V	400	60	1000	60	1000	μA
Gate Reverse Current	I _{GSS}	V _{GS} = -20 V, V _{DS} = 0 V	-0.6		-1		-1	pA
Gate Operating Current	I _G	V _{DG} = 10 V, I _D = 30 μA	-0.2		-0.25		-0.25	pA
Drain-Source On-Resistance	r _{DS(on)}	V _{GS} = 0 V, I _D = 10 μA	2000					Ω
Gate-Source Voltage	V _{GS}	V _{DG} = 10 V, I _D = 30 μA	-0.8		-1.8		-1.8	V
Gate-Source Forward Voltage	V _{GS(F)}	I _G = 1 mA, V _{DS} = 0 V	0.7					
Dynamic								
Common-Source Forward Transconductance	g _{fs}	V _{DS} = 10 V, V _{GS} = 0 V, f = 1 kHz	0.6	0.3	1.5	0.3	1.5	mS
Common-Source Output Conductance	g _{os}		4		10		10	μS
Common-Source Forward Transconductance	g _{fs}	V _{DS} = 10 V, I _D = 30 μA, f = 1 kHz	0.2	0.12	0.35	0.12	0.35	mS
Common-Source Output Conductance	g _{os}		0.4		3		3	μS
Common-Source Input Capacitance	C _{iss}	V _{DS} = 10 V, V _{GS} = 0 V, f = 1 MHz	1.4		3		3	pF
Common-Source Reverse Transfer Capacitance	C _{rss}		0.7		1.5		1.5	
Equivalent Input Noise Voltage	e _n	V _{DS} = 10 V, I _D = 30 μA, f = 10 Hz	30		70		70	nV/ √Hz
Noise Figure	NF	R _G = 10 MΩ			1		1	dB
Matching								
Differential Gate-Source Voltage	V _{GS1} - V _{GS2}	V _{DG} = 10 V, I _D = 30 μA			10		25	mV
Gate-Source Voltage Differential Change with Temperature	$\frac{\Delta V_{GS1} - V_{GS2} }{\Delta T}$	V _{DG} = 10 V, I _D = 30 μA T _A = -55 to 125 °C			10		40	μV/°C
Common Mode Rejection Ratio	CMRR	V _{DG} = 10 to 20 V, I _D = 30 μA	102	90		80		dB

Notes

a. Typical values are for DESIGN AID ONLY, not guaranteed or subject to production testing.

NNT

TYPICAL CHARACTERISTICS ($T_A = 25^\circ\text{C}$ UNLESS OTHERWISE NOTED)

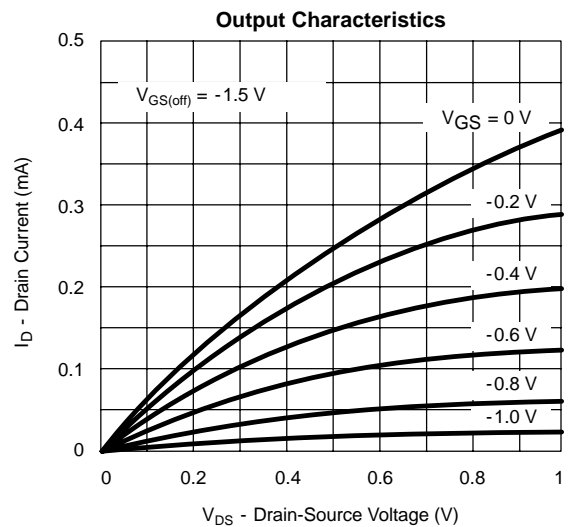
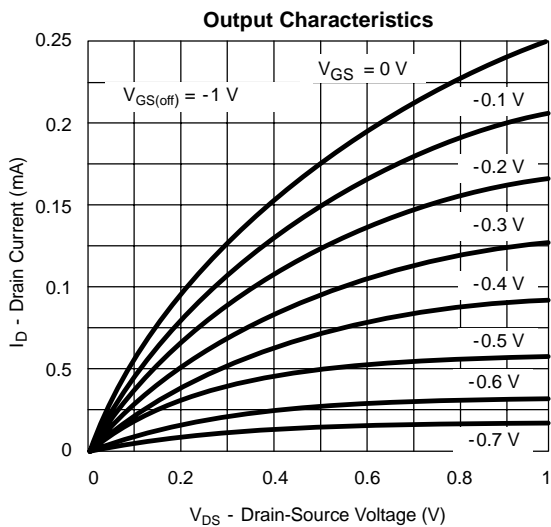
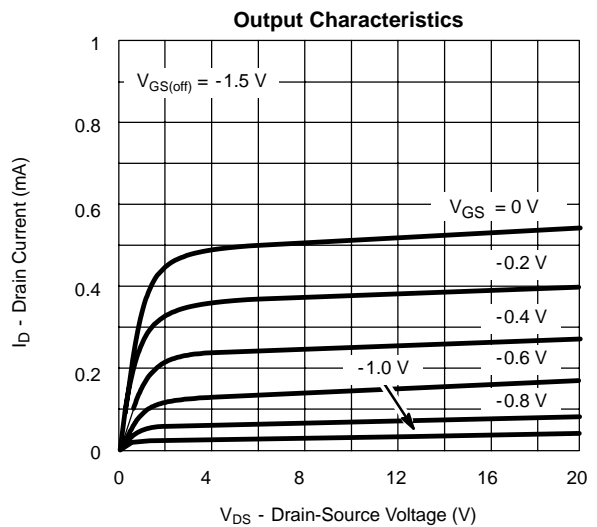
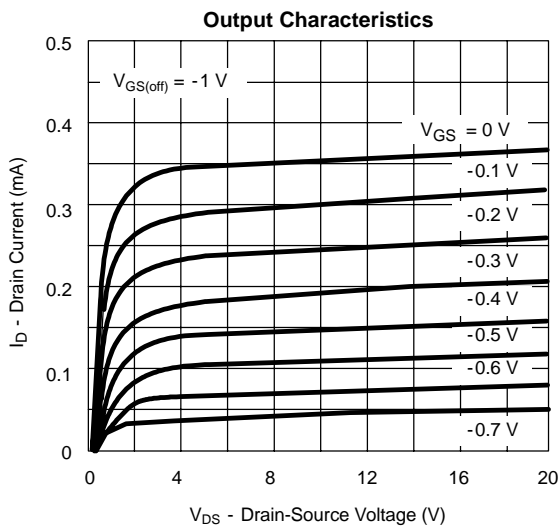
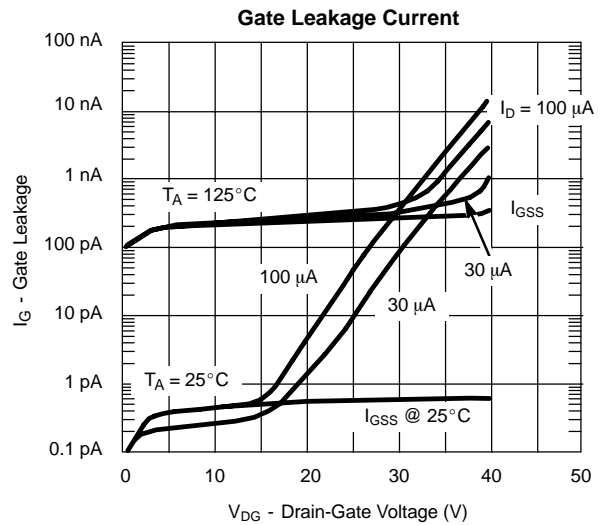
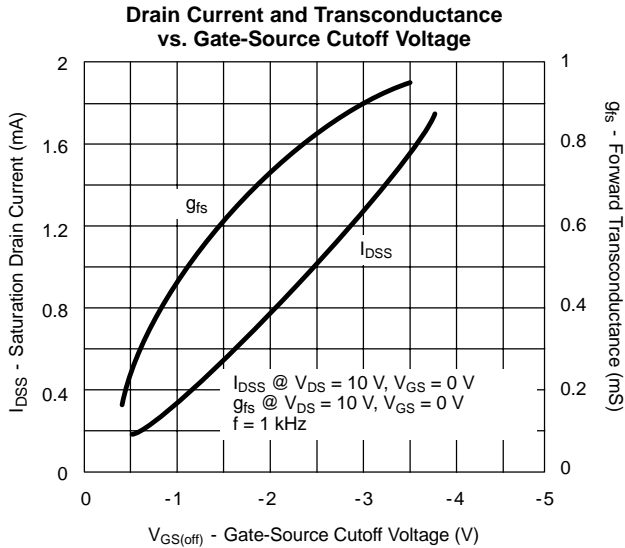



TYPICAL CHARACTERISTICS (T_A = 25°C UNLESS OTHERWISE NOTED)

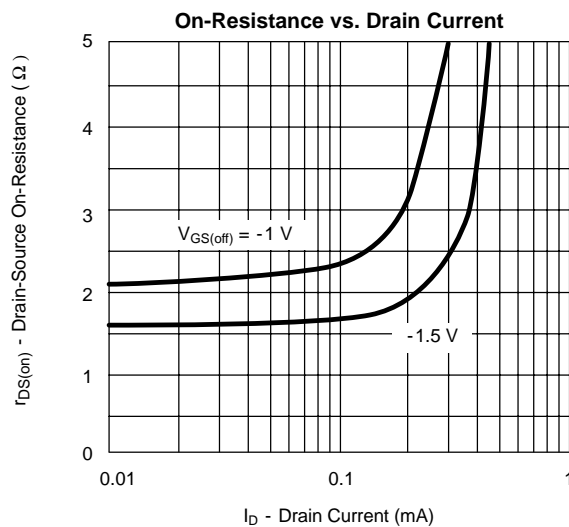
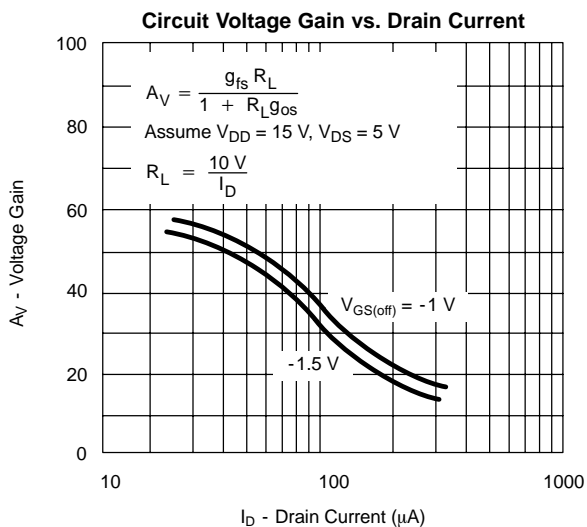
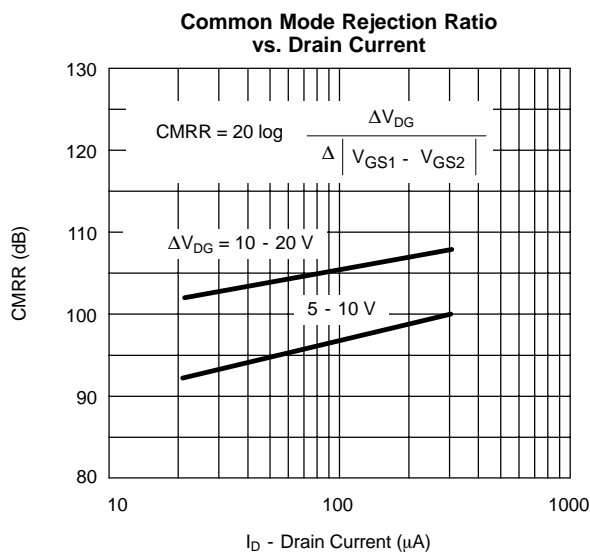
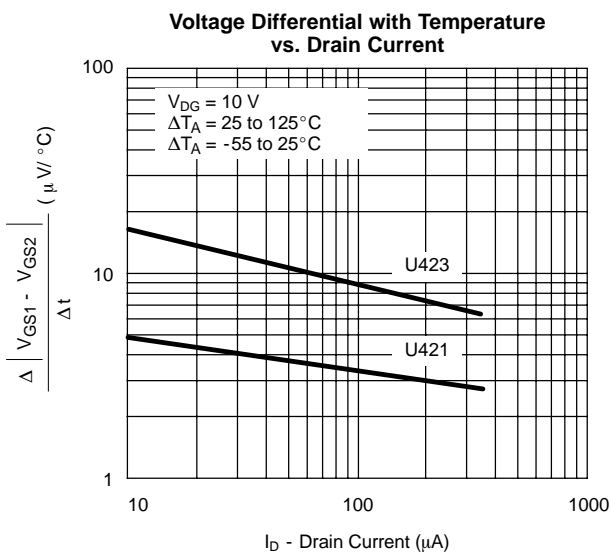
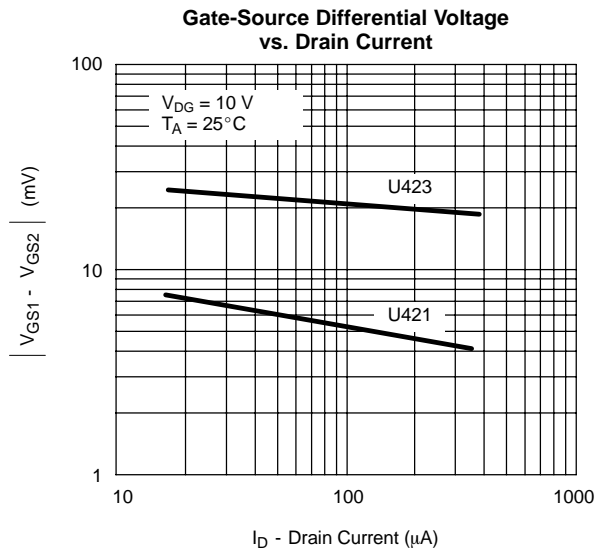
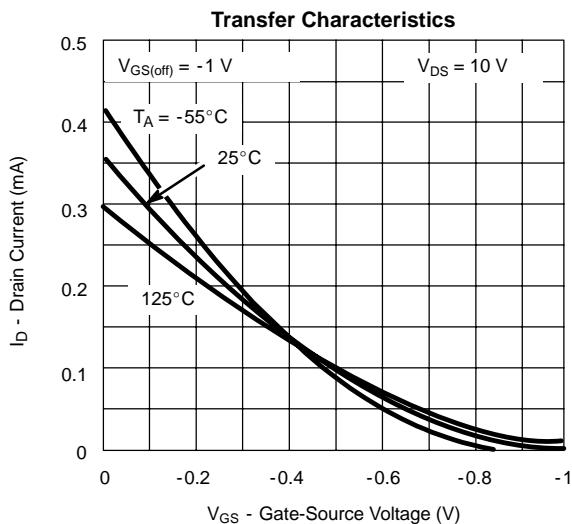

TYPICAL CHARACTERISTICS ($T_A = 25^\circ\text{C}$ UNLESS OTHERWISE NOTED)

Common-Source Input Capacitance vs. Gate-Source Voltage

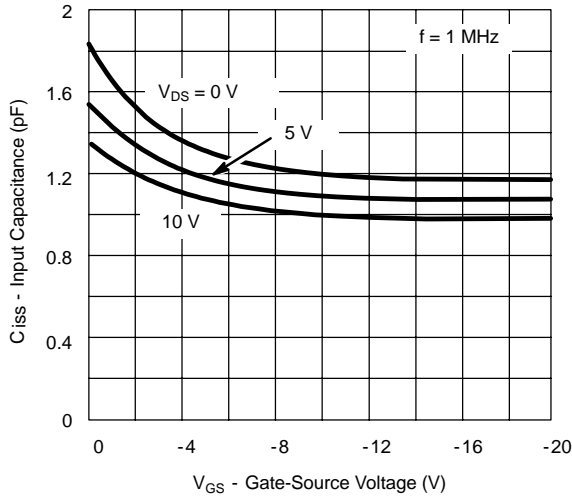

Common-Source Reverse Feedback Capacitance vs. Gate-Source Voltage

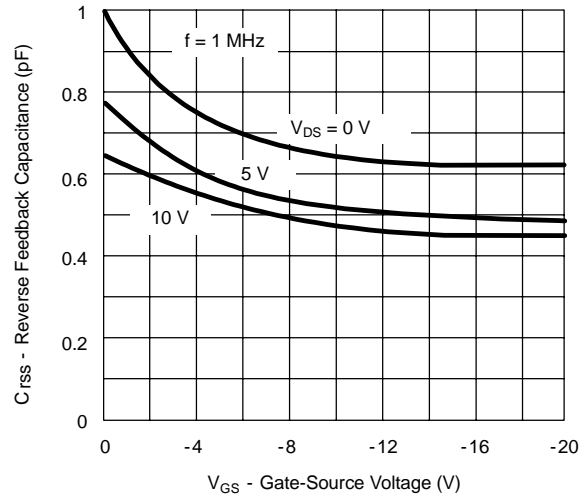

Output Conductance vs. Drain Current

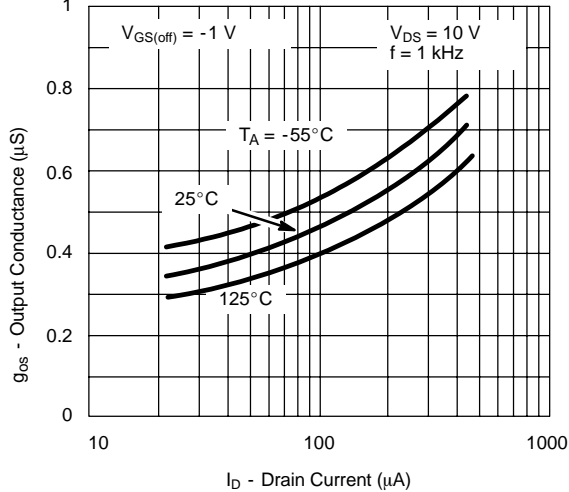

Equivalent Input Noise Voltage vs. Frequency

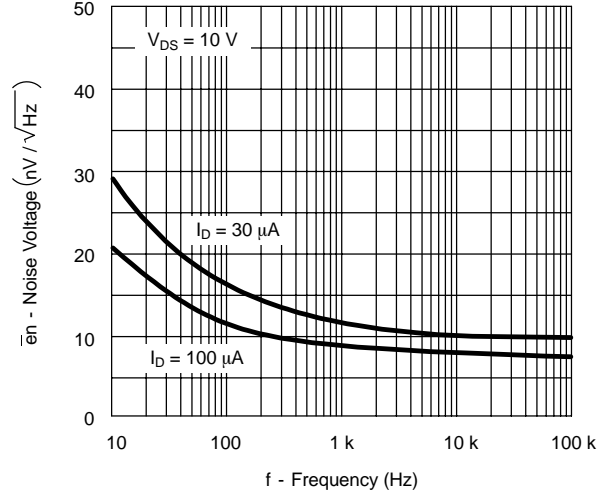

Common-Source Forward Transconductance vs. Drain Current

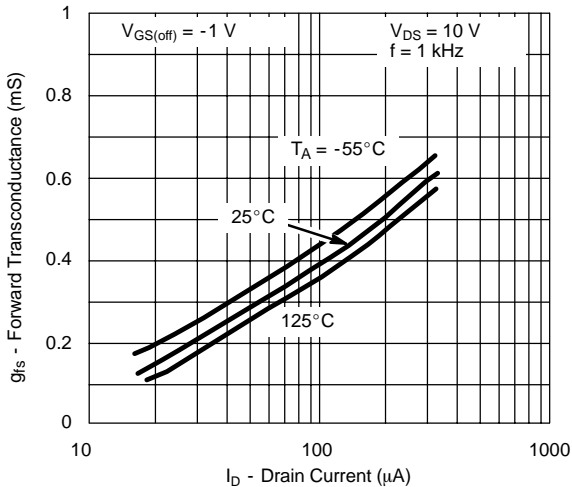

On-Resistance and Output Conductance vs. Gate-Source Cutoff Voltage

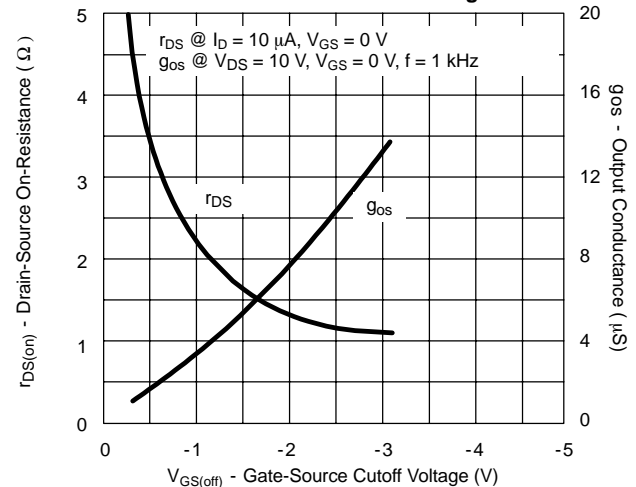



Disclaimer

All product specifications and data are subject to change without notice.

Vishay Intertechnology, Inc., its affiliates, agents, and employees, and all persons acting on its or their behalf (collectively, "Vishay"), disclaim any and all liability for any errors, inaccuracies or incompleteness contained herein or in any other disclosure relating to any product.

Vishay disclaims any and all liability arising out of the use or application of any product described herein or of any information provided herein to the maximum extent permitted by law. The product specifications do not expand or otherwise modify Vishay's terms and conditions of purchase, including but not limited to the warranty expressed therein, which apply to these products.

No license, express or implied, by estoppel or otherwise, to any intellectual property rights is granted by this document or by any conduct of Vishay.

The products shown herein are not designed for use in medical, life-saving, or life-sustaining applications unless otherwise expressly indicated. Customers using or selling Vishay products not expressly indicated for use in such applications do so entirely at their own risk and agree to fully indemnify Vishay for any damages arising or resulting from such use or sale. Please contact authorized Vishay personnel to obtain written terms and conditions regarding products designed for such applications.

Product names and markings noted herein may be trademarks of their respective owners.