



Monolithic N-Channel JFET Duals

PRODUCT SUMMARY					
Part Number	V _{GS(off)} (V)	V _{(BR)GSS} Min (V)	g _{fs} Min (mS)	I _G Max (pA)	V _{GS1} - V _{GS2} Max (mV)
U5545NL	-0.5 to -4.5	-50	1.5	-50	5
SST/U5546NL	-0.5 to -4.5	-50	1.5	-50	10
SST/U5547NL	-0.5 to -4.5	-50	1.5	-50	15

FEATURES

- Anti Latchup Capability
- Monolithic Design
- High Slew Rate
- Low Offset/Drift Voltage
- Low Gate Leakage: 3 pA
- Low Noise
- High CMRR: 100 dB

BENEFITS

- External Substrate Bias—Avoids Latchup
- Tight Differential Match vs. Current
- Improved Op Amp Speed, Settling Time Accuracy
- Minimum Input Error/Trimming Requirement
- Insignificant Signal Loss/Error Voltage
- High System Sensitivity
- Minimum Error with Large Input Signal

APPLICATIONS

- Wideband Differential Amps
- High-Speed, Temp-Compensated, Single-Ended Input Amps
- High-Speed Comparators
- Impedance Converters

DESCRIPTION

The SST/U5545NL Series are monolithic dual n-channel JFETs designed to provide high input impedance (I_G < 50 pA) for general purpose differential amplifiers. The U5545NL features minimum system error and calibration (5-mV offset maximum).

The SST5546NL/47NL in the SO-8 package provide ease of manufacturing. The symmetrical pinout prevents improper orientation. These part number are available with tape-and-reel options for compatibility with automatic assembly methods.

Pins 4 and 8 on the SST series and pin 4 on the U series part numbers enable the substrate to be connected to a positive, external bias (V_{DD}) to avoid latchup.

The hermetically sealed TO-78 package is available with full military processing.

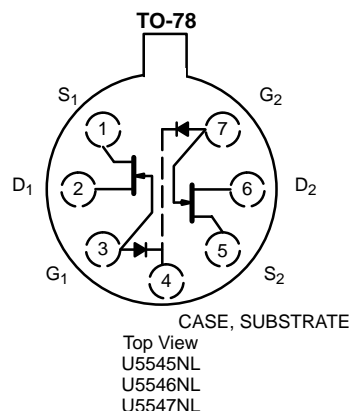
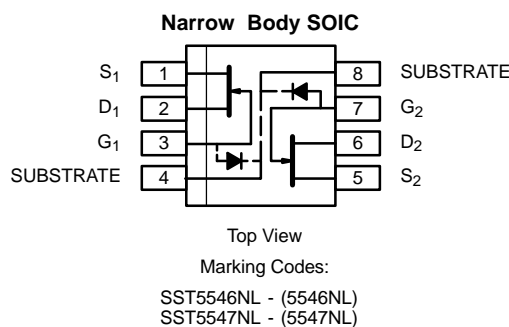

ABSOLUTE MAXIMUM RATINGS

Gate-Drain, Gate-Source Voltage -50 V
 Gate Current 30 mA
 Lead Temperature (1/16" from case for 10 sec.) 300°C
 Storage Temperature -65 to 200°C
 Operating Junction Temperature -55 to 150°C

Power Dissipation : Per Side^a 250 mW
 Total^b 500 mW

Notes
 a. Derate 2 mW/°C above 25°C
 b. Derate 4 mW/°C above 25°C

SPECIFICATIONS (T _A = 25 °C UNLESS OTHERWISE NOTED)										
Parameter	Symbol	Test Conditions	Typ ^a	Limits						Unit
				U5545NL		SST/U5546NL		SST/U5547NL		
				Min	Max	Min	Max	Min	Max	
Static										
Gate-Source Breakdown Voltage	V _{(BR)GSS}	I _G = -1 μA, V _{DS} = 0 V	-57	-50		-50		-50		V
Gate-Source Cutoff Voltage	V _{GS(off)}	V _{DS} = 15 V, I _D = 0.5 nA	-2	-0.5	-4.5	-0.5	-4.5	-0.5	-4.5	V
Saturation Drain Current ^b	I _{DSS}	V _{DS} = 15 V, V _{GS} = 0 V	3	0.5	8	0.5	8	0.5	8	mA
Gate Reverse Current	I _{GSS}	V _{GS} = -30 V, V _{DS} = 0 V	-10		-100		-100		-100	pA
		T _A = 150 °C	-20		-150		-150		-150	nA
Gate Operating Current	I _G	V _{DG} = 15 V, I _D = 200 μA	-3		-50		-50		-50	pA
Gate-Source Forward Voltage	V _{GS(F)}	I _G = 1 mA, V _{DS} = 0 V	0.7							V
Dynamic										
Common-Source Forward Transconductance ^b	g _{fs}	V _{DS} = 15 V, V _{GS} = 0 V f = 1 kHz	2.5	1.5	6.0	1.5	6.0	1.5	6.0	mS
Common-Source Output Conductance ^b	g _{os}		2		25		25		25	μS
Common-Source Input Capacitance	C _{iss}	V _{DS} = 15 V, V _{GS} = 0 V f = 1 MHz	3.5		6		6		6	pF
Common-Source Reverse Transfer Capacitance	C _{rss}		1.3		2		2		2	
Equivalent Input Noise Voltage	e _n	V _{DS} = 15 V, I _D = 200 μA f = 10 Hz	20		180					nV/ √Hz
Noise Figure	NF	R _G = 1 MΩ	0.1		3.5					dB
Matching										
Differential Gate-Source Voltage	V _{GS1} - V _{GS2}	V _{DG} = 15 V, I _D = 50 μA			5		10		15	mV
		V _{DG} = 15 V, I _D = 200 μA			5		10		15	
Gate-Source Voltage Differential Change with Temperature	$\frac{\Delta V_{GS1} - V_{GS2} }{\Delta T}$	V _{DG} = 15 V, I _D = 200 μA T _A = -55 to 125 °C			10		20		40	μV/ °C
Saturation Drain Current Ratio ^c	$\frac{I_{DSS1}}{I_{DSS2}}$	V _{DS} = 15 V, V _{GS} = 0 V	0.98 ^c	0.95	1	0.9	1	0.9	1	
Transconductance Ratio ^c	$\frac{g_{fs1}}{g_{fs2}}$	V _{DS} = 15 V, I _D = 200 μA f = 1 kHz	0.99 ^c	0.97	1	0.95	1	0.9	1	

Notes

- Typical values are for DESIGN AID ONLY, not guaranteed nor subject to production testing.
- Pulse test: PW ≤ 300 μs duty cycle ≤ 3%.
- Assumes smaller value in the numerator.

NQP



TYPICAL CHARACTERISTICS ($T_A = 25^\circ\text{C}$ UNLESS OTHERWISE NOTED)

Drain Current and Transconductance vs. Gate-Source Cutoff Voltage

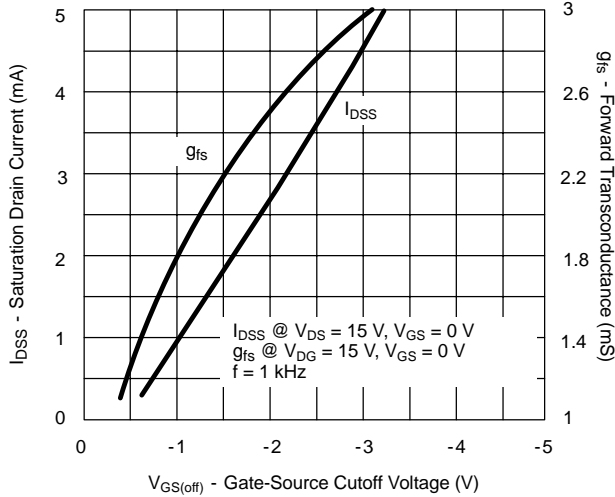

Gate Leakage Current

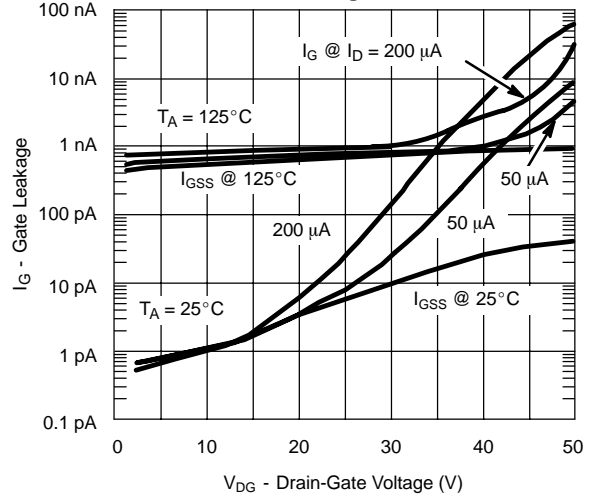

Output Characteristics

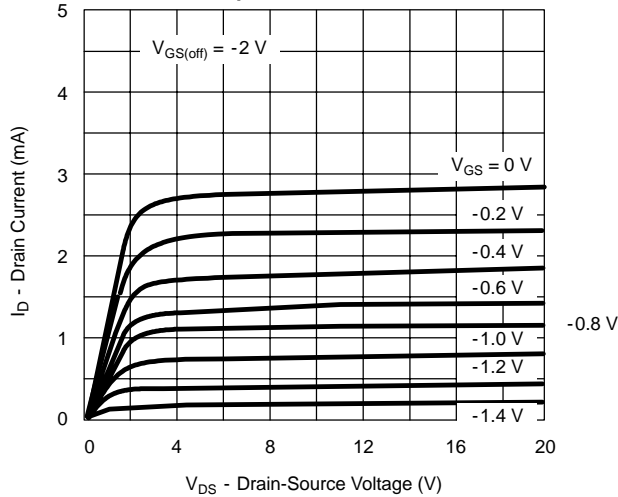

Output Characteristics

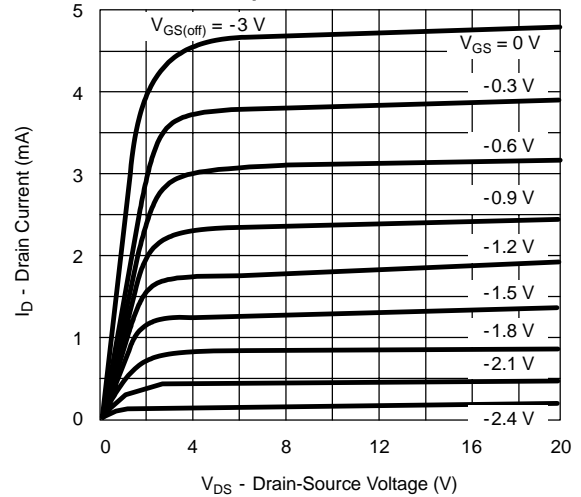

Output Characteristics

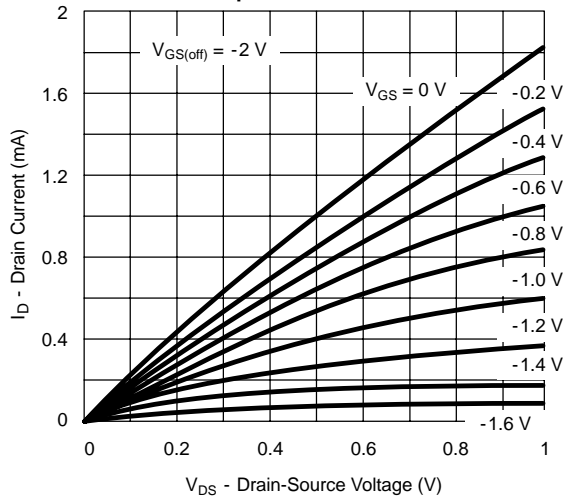

Output Characteristics

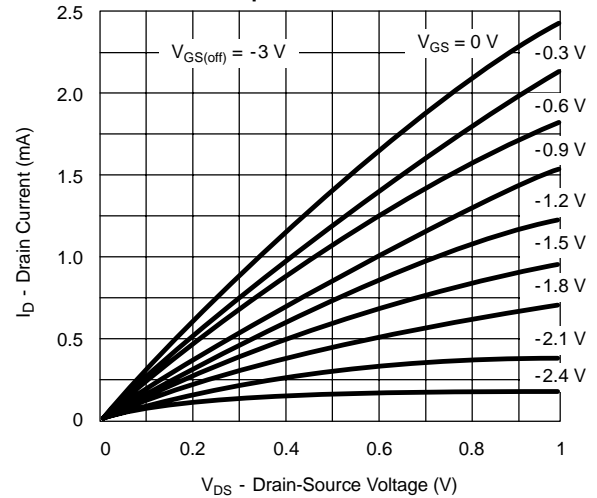

TYPICAL CHARACTERISTICS ($T_A = 25^\circ\text{C}$ UNLESS OTHERWISE NOTED)

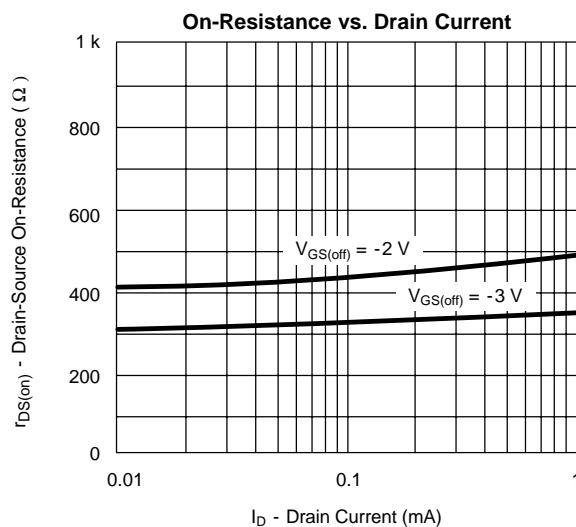
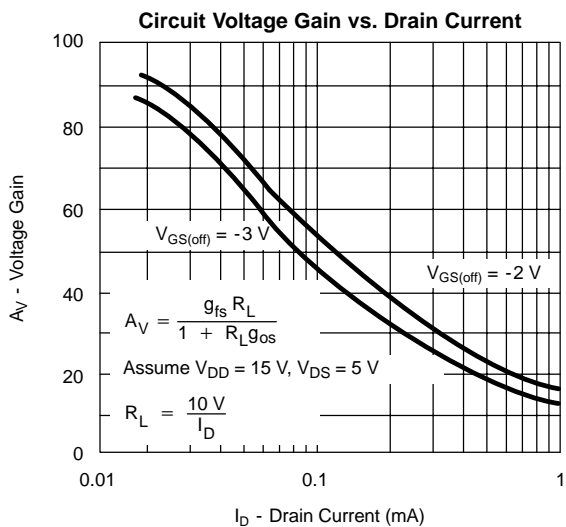
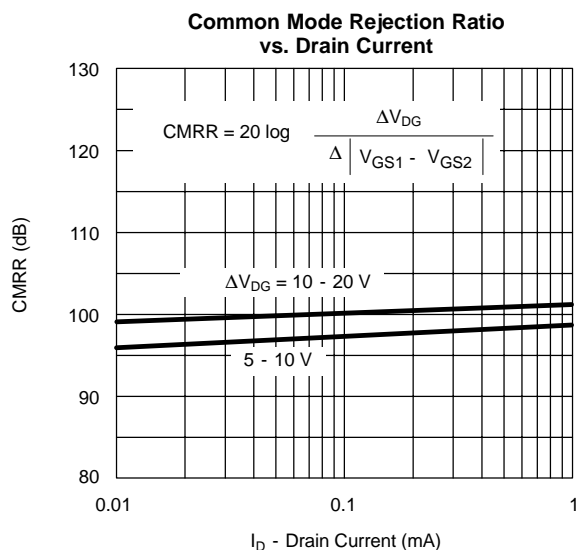
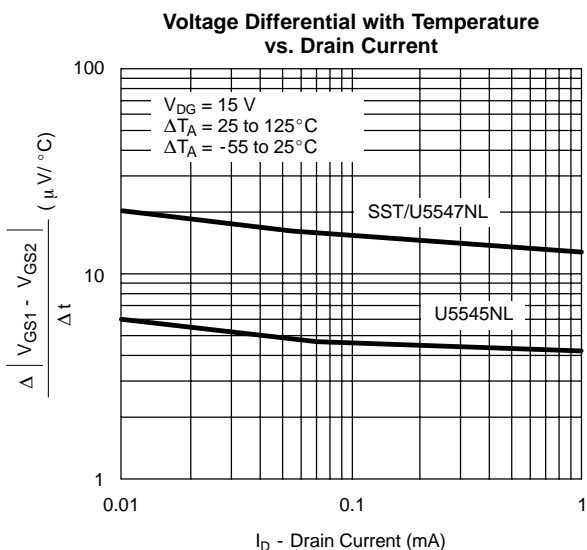
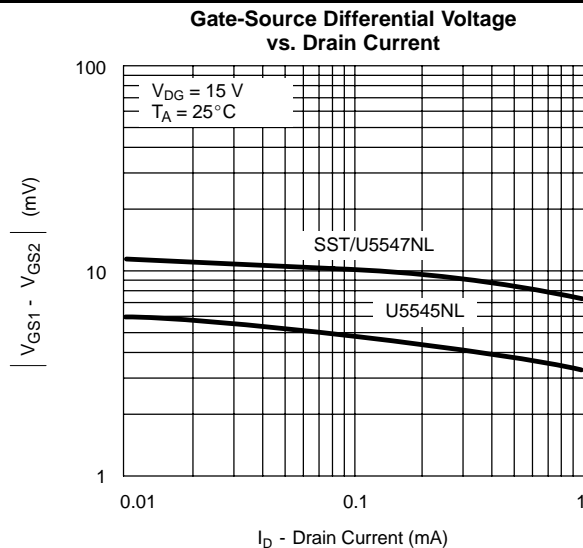
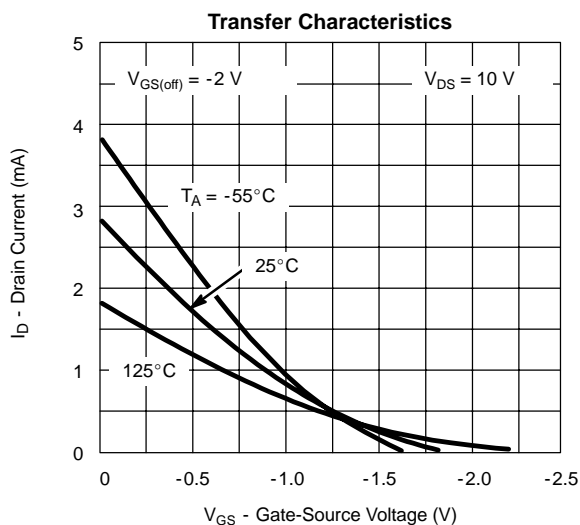

TYPICAL CHARACTERISTICS ($T_A = 25^\circ\text{C}$ UNLESS OTHERWISE NOTED)

Common-Source Input Capacitance vs. Gate-Source Voltage

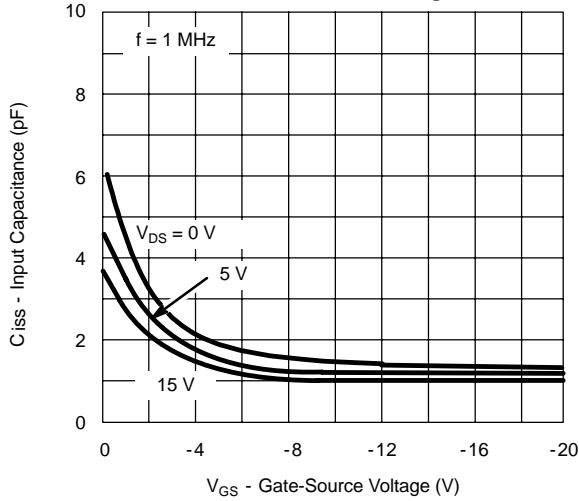

Common-Source Reverse Feedback Capacitance vs. Gate-Source Voltage

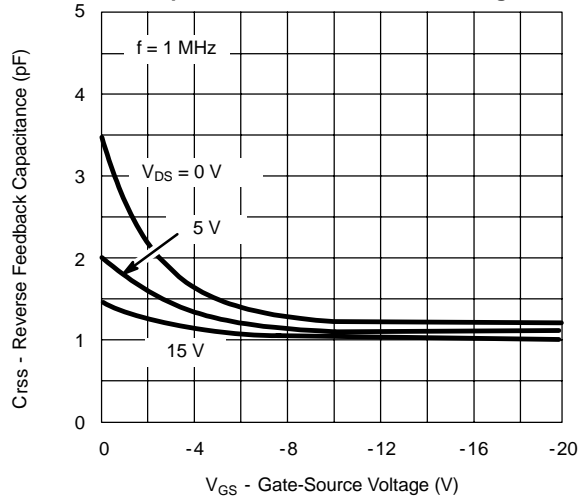

Equivalent Input Noise Voltage vs. Frequency

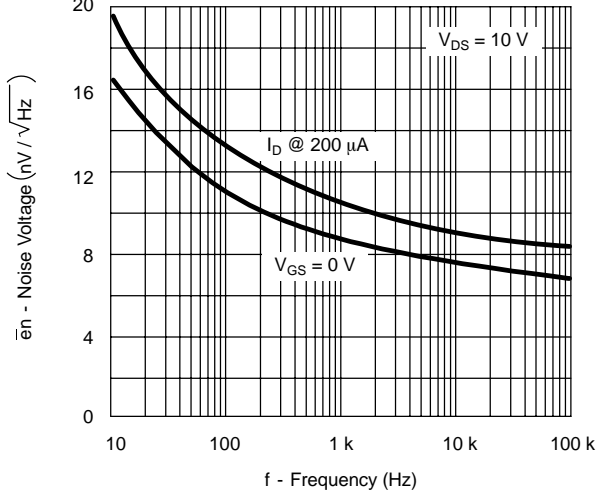

Output Conductance vs. Drain Current

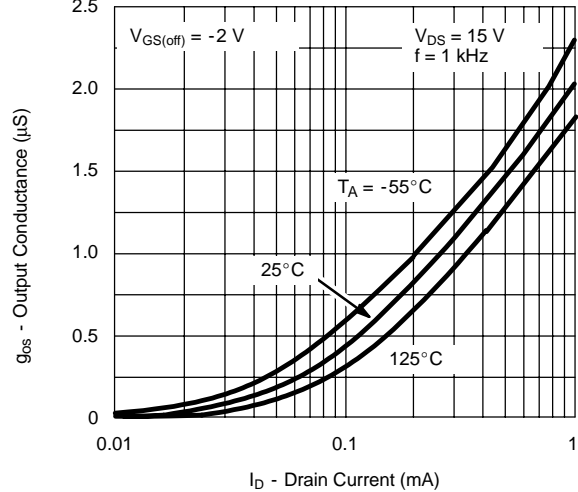

Common-Source Forward Transconductance vs. Drain Current

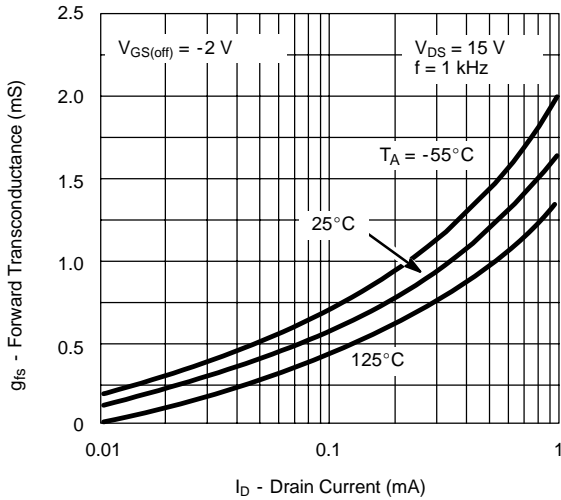

On-Resistance and Output Conductance vs. Gate-Source Cutoff Voltage

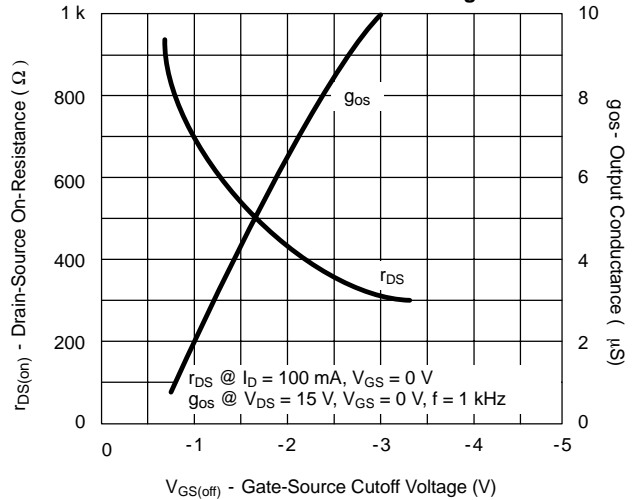



Disclaimer

All product specifications and data are subject to change without notice.

Vishay Intertechnology, Inc., its affiliates, agents, and employees, and all persons acting on its or their behalf (collectively, "Vishay"), disclaim any and all liability for any errors, inaccuracies or incompleteness contained herein or in any other disclosure relating to any product.

Vishay disclaims any and all liability arising out of the use or application of any product described herein or of any information provided herein to the maximum extent permitted by law. The product specifications do not expand or otherwise modify Vishay's terms and conditions of purchase, including but not limited to the warranty expressed therein, which apply to these products.

No license, express or implied, by estoppel or otherwise, to any intellectual property rights is granted by this document or by any conduct of Vishay.

The products shown herein are not designed for use in medical, life-saving, or life-sustaining applications unless otherwise expressly indicated. Customers using or selling Vishay products not expressly indicated for use in such applications do so entirely at their own risk and agree to fully indemnify Vishay for any damages arising or resulting from such use or sale. Please contact authorized Vishay personnel to obtain written terms and conditions regarding products designed for such applications.

Product names and markings noted herein may be trademarks of their respective owners.