

FEATURES

- **LOW COST PLASTIC SURFACE MOUNT PACKAGE**
Available on Tape and Reel
- **USABLE TO 3.7 GHz:**
Fixed Wireless Access, ISM, WLL, MMDS, IMT-2000, PCS
- **HIGH OUTPUT POWER:**
35 dBm TYP with 5.0 V Vdc
32.5 dBm TYP with 3.5 V Vdc
- **HIGH LINEAR GAIN:**
10 dB TYP at 1.9 GHz
- **LOW THERMAL RESISTANCE:**
5°C/W

DESCRIPTION

NEC's NE6510179A is a GaAs HJ-FET designed for medium power mobile communications, Fixed Wireless Access, ISM, WLL, PCS, IMT-2000, and MMDS transmitter and subscriber applications. It is capable of delivering 1.8 watts of output power(C/W) at 3.5 V and 3 Watts of ouptut power (CW) at 5 V with high linear gain, high efficiency, and excellent linearity. Reliability and performance uniformity are assured by NEC's stringent quality and control procedures.

OUTLINE DIMENSIONS (Units in mm)

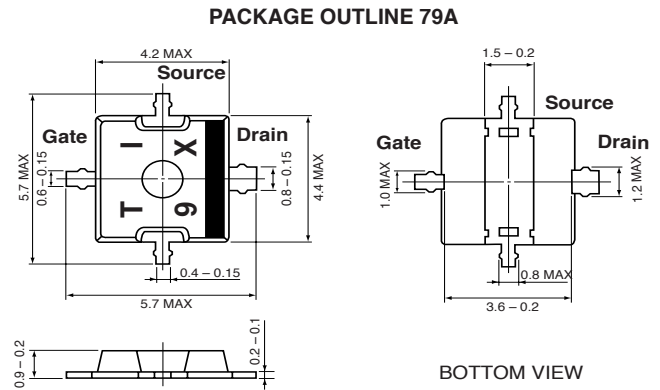

Note: Unless otherwise specified, tolerance is ± 0.2 mm

ELECTRICAL CHARACTERISTICS (T_c = 25°C)

PART NUMBER				NE6510179A			TEST CONDITIONS
PACKAGE OUTLINE				79A			
SYMBOLS	CHARACTERISTICS	UNITS	MIN	TYP	MAX		
Functional Characteristics	P _{OUT}	Output Power	dBm	31.5	32.5		f = 1900 MHz, V _{DS} = 3.5 V, Pin = +25 dBm, R _g = 100 Ω, I _{DSQ} = 200 mA (RF OFF) ²
	GL	Linear Gain ¹	dB		10.0		
	η _{ADD}	Power Added Efficiency	%	50	58		
	I _D	Drain Current	A		0.72		
Electrical DC Characteristics	I _{DSS}	Saturated Drain Current	A		2.4		V _{DS} = 2.5 V; V _{GS} = 0 V
	V _P	Pinch-Off Voltage	V	-2.0		-0.4	V _{DS} = 2.5 V; I _D = 14 mA
	R _{TH}	Thermal Resistance	°C/W		5	8	Channel to Case
	BV _{GD}	Gate to Drain Breakdown Voltage	V	12			I _{GD} = 14 mA

Notes:

1. Pin = 0 dBm
2. DC performance is tested 100% . Several samples per wafer are tested for RF performance. Wafer rejection criteria for standard devices is 1 reject for several samples.

TYPICAL RF PERFORMANCE FOR REFERENCE (NOT SPECIFIED) (T_C = 25°C)

SYMBOLS	CHARACTERISTICS	UNITS	MIN	TYP	MAX	TEST CONDITIONS
P _{OUT}	Output Power	dBm		35.0		f = 1900 MHz, V _{DS} = 5.0 V, Pin = +25 dBm, R _g = 100 Ω I _{DSQ} = 200 mA (RF OFF)
G _L	Linear Gain ¹	dB		10.0		
η _{ADD}	Power Added Efficiency	%		56		
I _D	Drain Current	A		1.2		
P _{OUT}	Output Power	dBm		31.5		f = 900 MHz, V _{DS} = 3.5 V, Pin = +20 dBm, R _g = 100 Ω I _{DSQ} = 200 mA (RF OFF)
G _L	Linear Gain ¹	dB		15.0		
η _{ADD}	Power Added Efficiency	%		70		
I _D	Drain Current	A		0.53		

Notes:

- Pin = 0 dBm

ABSOLUTE MAXIMUM RATINGS¹ (T_C = 25 °C)

SYMBOLS	PARAMETERS	UNITS	RATINGS
V _{DS}	Drain to Source Voltage	V	8
V _{GS}	Gate to Source Voltage	V	-4
I _{DS}	Drain Current	A	2.8
I _{GS}	Gate Current (I _{GF} , I _{GR})	mA	±25
P _T	Total Power Dissipation ²	W	15
T _{CH}	Channel Temperature	°C	150
T _{STG}	Storage Temperature	°C	-65 to +150

Note:

- Operation in excess of any one of these parameters may result in permanent damage.

RECOMMENDED OPERATING LIMITS

SYMBOLS	PARAMETERS	UNITS	TYP	MAX
V _{DS}	Drain to Source Voltage	V	3.5	6.0
T _{CH}	Channel Temperature	°C		+125
G _{COMP}	Gain Compression ¹	dB		3.0

Note:

- Recommended maximum gain compression is 3.0 dB at V_{DS} > 4.2 V.

ORDERING INFORMATION

PART NUMBER	QTY
NE6510179A-T1-A	1 K/Reel
NE6510179A-A	Bulk, 100 piece min.

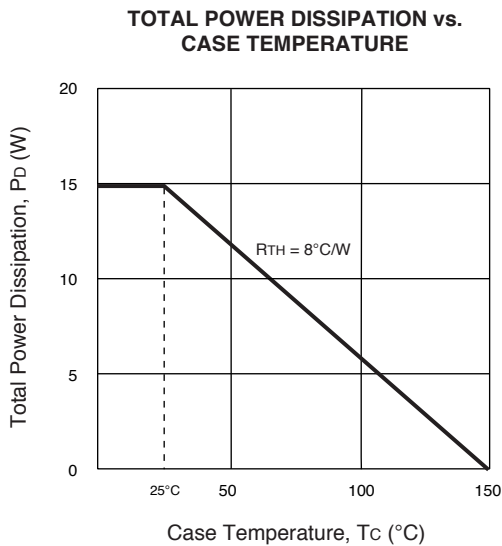

TYPICAL PERFORMANCE CURVES ($T_A = 25^\circ\text{C}$)

DRAIN CURRENT vs. DRAIN VOLTAGE

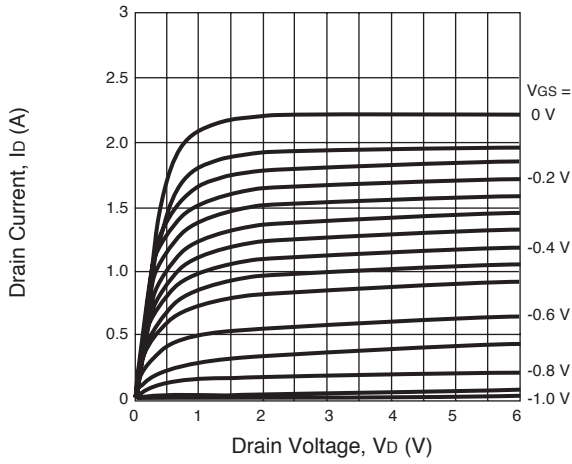

TRANSCONDUCTANCE AND DRAIN CURRENT vs. GATE VOLTAGE

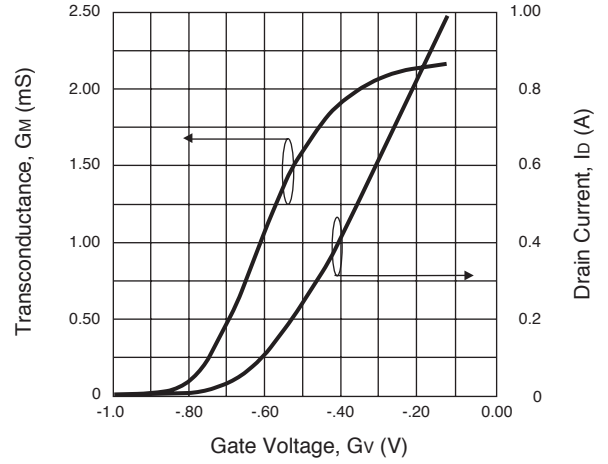

ARRHENIUS PLOTS vs. JUNCTION TEMPERATURE

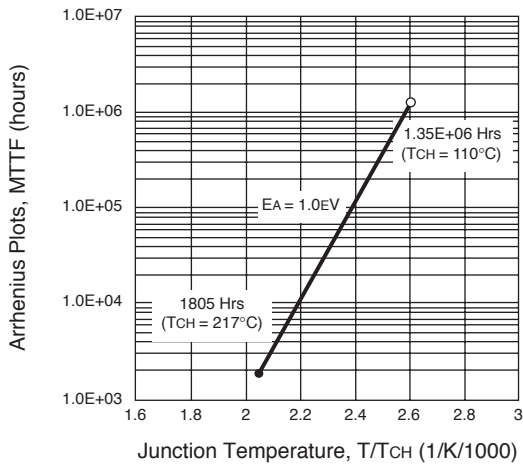

MAXIMUM AVAILABLE GAIN vs. FREQUENCY

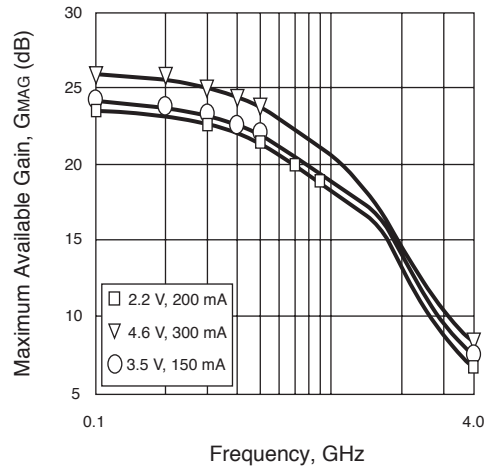

TYPICAL SCATTERING PARAMETERS (T_A = 25°C)

Note: This file and many other s-parameter files can be downloaded from www.cel.com

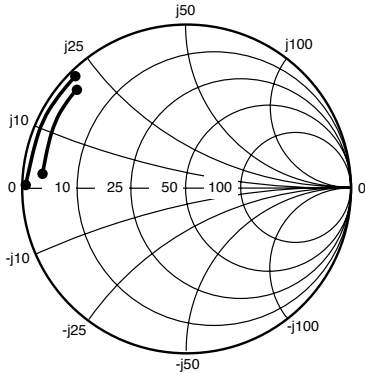

Coordinates in Ohms
Frequency in GHz
V_D = 3.5 V, I_D = 150 mA

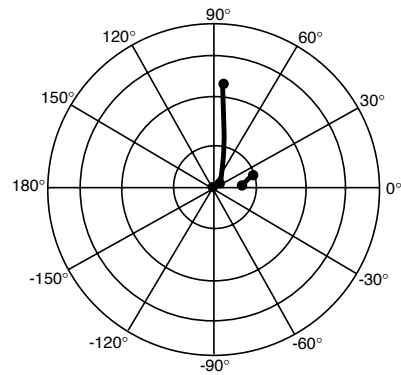

NE6510179A

V_D = 3.5 V, I_D = 150 mA

FREQUENCY	S ₁₁		S ₂₁		S ₁₂		S ₂₂		K	MAG ¹
	GHz	MAG	ANG	MAG	ANG	MAG	ANG	MAG		
0.50	0.956	179.67	2.813	82.32	0.018	5.20	0.842	176.48	0.29	21.87
0.60	0.955	177.71	2.343	79.83	0.018	5.02	0.842	175.21	0.34	21.09
0.70	0.956	175.93	2.016	77.44	0.018	5.41	0.843	173.93	0.40	20.38
0.80	0.955	174.33	1.765	75.21	0.018	5.58	0.843	172.76	0.46	19.81
0.90	0.955	172.86	1.573	73.00	0.019	5.93	0.842	171.63	0.51	19.24
1.00	0.955	171.45	1.418	70.78	0.019	6.32	0.842	170.47	0.57	18.79
1.10	0.955	170.09	1.289	68.54	0.019	6.08	0.841	169.22	0.62	18.33
1.20	0.954	168.81	1.187	66.57	0.019	6.55	0.843	168.26	0.67	17.95
1.30	0.954	167.51	1.097	64.47	0.019	6.48	0.842	167.19	0.72	17.59
1.40	0.953	166.27	1.021	62.40	0.019	6.73	0.842	166.12	0.78	17.26
1.50	0.953	165.06	0.955	60.35	0.019	6.94	0.843	165.06	0.82	16.92
1.60	0.953	163.84	0.898	58.36	0.019	6.98	0.843	164.05	0.88	16.65
1.70	0.953	162.63	0.847	56.38	0.020	7.33	0.843	163.06	0.92	16.36
1.80	0.952	161.41	0.802	54.34	0.020	7.16	0.842	161.99	0.98	16.12
1.90	0.951	160.23	0.761	52.35	0.020	7.48	0.844	160.95	1.05	14.59
2.00	0.951	159.05	0.726	50.45	0.020	8.27	0.844	159.99	1.10	13.76
2.10	0.952	157.87	0.693	48.50	0.020	8.79	0.845	159.02	1.13	13.19
2.20	0.951	156.61	0.662	46.53	0.020	8.70	0.844	158.03	1.20	12.48
2.30	0.951	155.50	0.635	44.55	0.020	8.69	0.845	157.05	1.23	12.10
2.40	0.950	154.36	0.611	42.67	0.020	8.71	0.846	156.09	1.27	11.66
2.50	0.950	153.22	0.587	40.91	0.020	8.92	0.847	155.25	1.31	11.27
2.60	0.950	152.11	0.565	39.04	0.020	8.87	0.847	154.33	1.37	10.81
2.70	0.950	150.95	0.545	37.19	0.020	9.41	0.848	153.36	1.41	10.49
2.80	0.950	149.81	0.528	35.36	0.021	9.87	0.850	152.46	1.44	10.17
2.90	0.949	148.69	0.510	33.69	0.020	10.32	0.852	151.70	1.50	9.81
3.00	0.949	147.51	0.494	31.91	0.021	10.98	0.852	150.82	1.52	9.50
3.10	0.949	146.33	0.478	30.21	0.021	11.59	0.854	149.99	1.59	9.17
3.20	0.949	145.20	0.465	28.41	0.021	12.25	0.855	149.11	1.58	8.94
3.30	0.950	144.05	0.452	26.80	0.021	13.46	0.857	148.32	1.61	8.71
3.40	0.949	142.93	0.439	25.05	0.022	13.17	0.858	147.55	1.62	8.41
3.50	0.949	141.85	0.427	23.40	0.022	13.36	0.860	146.79	1.64	8.21
3.60	0.949	140.70	0.416	21.75	0.022	13.56	0.862	146.14	1.64	8.00
3.70	0.949	139.60	0.405	20.23	0.023	13.89	0.864	145.53	1.64	7.85
3.80	0.949	138.47	0.394	18.70	0.023	13.96	0.865	145.01	1.65	7.64
3.90	0.951	137.45	0.384	17.31	0.023	14.08	0.869	144.58	1.59	7.67
4.00	0.950	136.38	0.374	15.99	0.023	14.68	0.875	144.34	1.59	7.50

Note:

1. Gain Calculation:

$$MAG = \frac{|S_{21}|}{|S_{12}|} (K \pm \sqrt{K^2 - 1})$$

When $K \leq 1$, MAG is undefined and MSG values are used. $MSG = \frac{|S_{21}|}{|S_{12}|}$, $K = \frac{1 + |\Delta|^2 - |S_{11}|^2 - |S_{22}|^2}{2 |S_{12} S_{21}|}$, $\Delta = S_{11} S_{22} - S_{21} S_{12}$

MAG = Maximum Available Gain

MSG = Maximum Stable Gain

NE6510179A

TYPICAL SCATTERING PARAMETERS (T_A = 25°C)

Note: This file and many other s-parameter files can be downloaded from www.cel.com

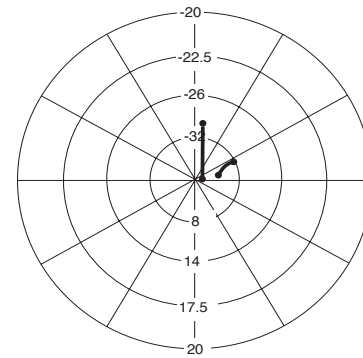
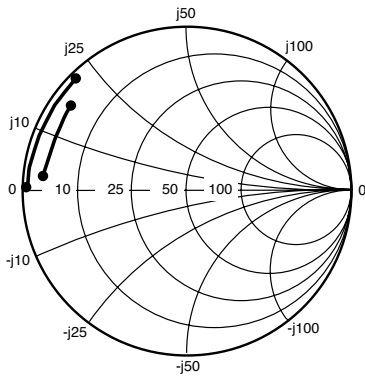

Coordinates in Ohms
Frequency in GHz
V_D = 5.0 V, I_D = 300 mA

NE6510179A

V_D = 5.0 V, I_D = 300 mA

FREQUENCY GHz	S ₁₁		S ₂₁		S ₁₂		S ₂₂		K	MAG ¹ (dB)
	MAG	ANG	MAG	ANG	MAG	ANG	MAG	ANG		
0.50	0.964	179.30	3.090	82.99	0.013	11.07	0.863	175.80	0.38	23.76
0.60	0.963	177.40	2.574	80.69	0.013	12.04	0.862	174.60	0.45	22.97
0.70	0.964	175.60	2.215	78.48	0.013	13.41	0.863	173.30	0.52	22.31
0.80	0.963	174.00	1.940	76.44	0.013	14.52	0.863	172.10	0.59	21.74
0.90	0.963	172.60	1.730	74.41	0.014	15.48	0.862	171.00	0.63	20.92
1.00	0.962	171.20	1.559	72.36	0.014	16.81	0.862	169.90	0.71	20.47
1.10	0.962	169.80	1.418	70.30	0.014	17.13	0.861	164.30	0.77	20.06
1.20	0.962	168.50	1.306	68.47	0.014	18.35	0.862	167.60	0.83	19.70
1.30	0.962	167.20	1.207	66.55	0.015	18.76	0.861	166.50	0.85	19.06
1.40	0.961	166.00	1.124	64.61	0.015	19.61	0.861	165.40	0.92	18.75
1.50	0.961	164.80	1.053	62.72	0.015	20.22	0.861	164.30	0.97	18.46
1.60	0.960	163.60	0.990	60.89	0.015	20.71	0.862	163.30	1.03	17.10
1.70	0.960	162.40	0.934	59.08	0.016	21.61	0.861	162.30	1.05	16.30
1.80	0.960	161.10	0.885	57.16	0.016	21.54	0.860	161.20	1.10	15.55
1.90	0.959	159.90	0.841	55.31	0.016	22.43	0.861	160.10	1.16	14.76
2.00	0.959	158.80	0.803	53.56	0.016	23.77	0.861	159.10	1.22	14.17
2.10	0.959	157.60	0.766	51.76	0.017	24.20	0.861	158.20	1.22	13.71
2.20	0.958	156.30	0.733	49.92	0.017	24.45	0.859	157.20	1.29	13.09
2.30	0.958	155.20	0.704	48.04	0.017	24.16	0.860	156.10	1.32	12.76
2.40	0.957	154.00	0.677	46.31	0.018	24.58	0.862	155.10	1.33	12.33
2.50	0.957	152.90	0.652	44.72	0.018	24.86	0.863	154.30	1.36	11.99
2.60	0.957	151.80	0.627	42.98	0.018	24.96	0.861	153.40	1.42	11.58
2.70	0.957	150.60	0.606	41.20	0.018	25.58	0.862	152.40	1.46	11.27
2.80	0.957	149.50	0.587	39.47	0.019	25.67	0.864	151.40	1.43	11.01
2.90	0.956	148.30	0.568	37.95	0.019	26.27	0.865	150.70	1.49	10.63
3.00	0.956	147.20	0.550	36.32	0.019	27.34	0.865	149.80	1.54	10.30
3.10	0.956	146.00	0.534	34.72	0.020	28.08	0.868	149.00	1.52	10.01
3.20	0.956	144.80	0.519	32.99	0.020	28.08	0.868	148.00	1.54	9.81
3.30	0.957	143.70	0.505	31.47	0.021	29.01	0.869	147.20	1.51	9.61
3.40	0.955	142.50	0.491	29.85	0.021	28.15	0.869	146.50	1.57	9.24
3.50	0.955	141.50	0.478	28.29	0.022	28.47	0.870	145.70	1.55	8.99
3.60	0.955	140.30	0.467	26.73	0.022	28.09	0.873	145.00	1.55	8.89
3.70	0.955	139.20	0.455	25.35	0.023	28.10	0.873	144.40	1.54	8.64
3.80	0.956	138.00	0.443	23.91	0.023	27.80	0.874	143.90	1.54	8.53
3.90	0.957	137.00	0.431	22.54	0.024	27.69	0.877	143.50	1.48	8.44
4.00	0.956	135.90	0.421	21.29	0.024	27.86	0.883	143.20	1.49	8.32

Note:

1. Gain Calculation:

$$MAG = \frac{|S_{21}|}{|S_{12}|} \left(K \pm \sqrt{K^2 - 1} \right). \text{ When } K \leq 1, \text{ MAG is undefined and MSG values are used. } MSG = \frac{|S_{21}|}{|S_{12}|}, K = \frac{1 + |\Delta|^2 - |S_{11}|^2 - |S_{22}|^2}{2 |S_{12} S_{21}|}, \Delta = S_{11} S_{22} - S_{21} S_{12}$$

MAG = Maximum Available Gain

MSG = Maximum Stable Gain

APPLICATION CIRCUIT (1.93-1.99 GHz)

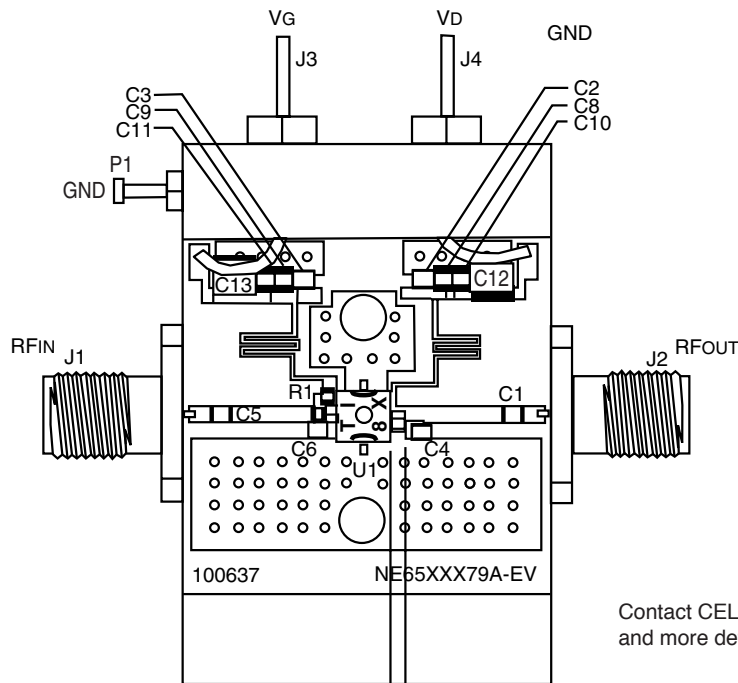

Contact CEL Engineering for artwork and more detailed information.

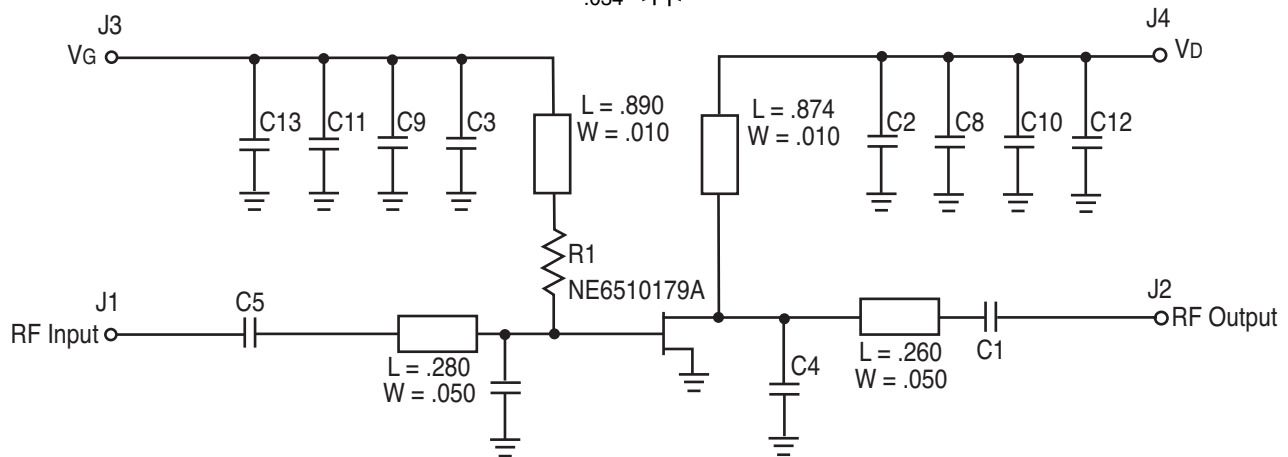

1	TF-100637		TEST CIRCUIT BLK	17
4			2-56 X 3/16 PHILLIPS PAN HEAD	16
2	MA101J	C2, C3	CASE 1 100 pF CAP MURATA	15
1	MCR03J200	R1	0603 20 OHM RESISTOR ROHM	14
1	100A6RBCP150X	C14 NOT USED	CASE A 6.8 pF CAP ATC	13
1	100A4R3CP150X	C4	CASE A 4.3 pF CAP ATC	12
2	100A240CP150X	C5, C1	CASE A 24 pF CAP ATC	11
1	100A4R7CP150X	C6	CASE A 4.7 pF CAP ATC	10
1	100A1RBCP150X	C7 NOT USED	CASE A 1.8 pF CAP ATC	9
2	TAJB475K010R	C12, C13	CASE B 4.7 μF CAP AVX	8
2	GRM40X7R104K025BL	C10, C11	0805 .1 μF CAP MURATA	7
2	GRM40C0G102J050BD	C8, C9	0805 1000 pF CAP MURATA	6
1	NE6510179A	U1	IC NEC	5
1	703401	P1	GROUND LUG CONCORD	4
1	1250-003	J3, J4	FEEDTHRU MURATA	3
2	2052-5636-02	J1, J2	FLANGE MOUNT JACK RECEPTACLE	2

TYPICAL APPLICATION CIRCUIT PERFORMANCE at $V_{DS} = 3\text{ V}$ and $V_{DS} = 5\text{ V}$

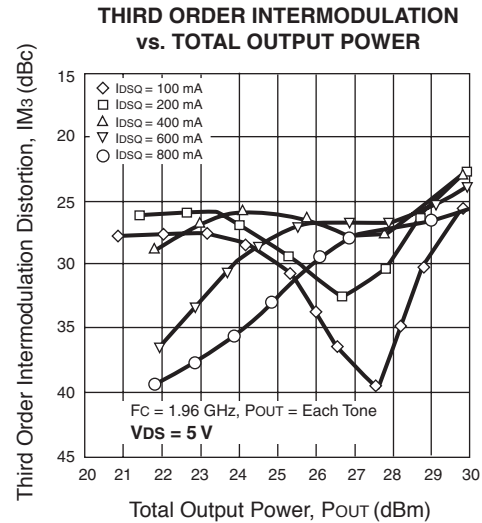
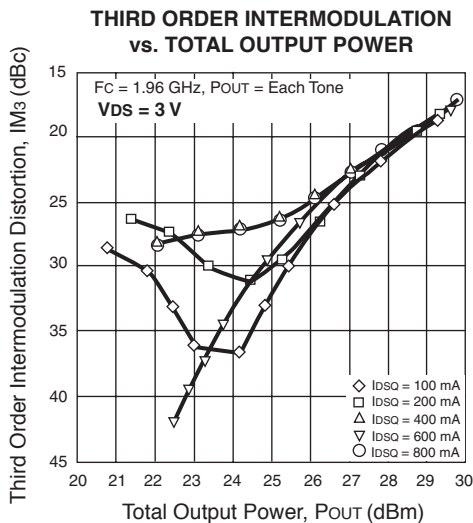
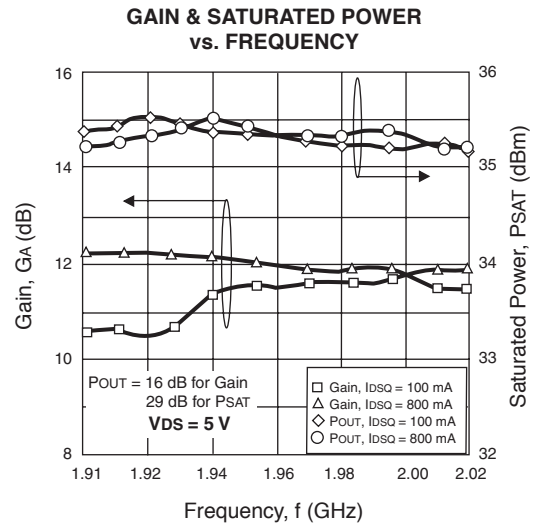
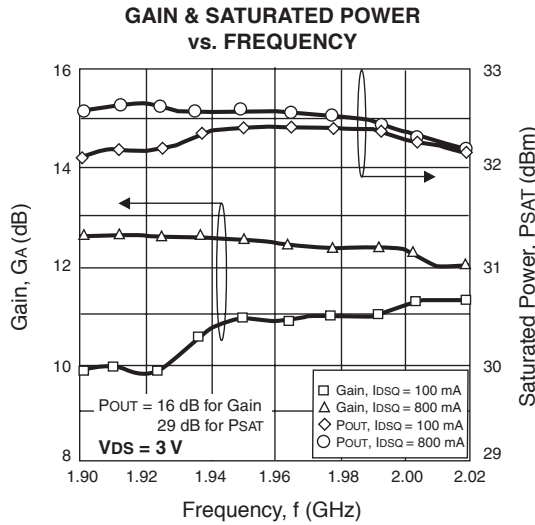
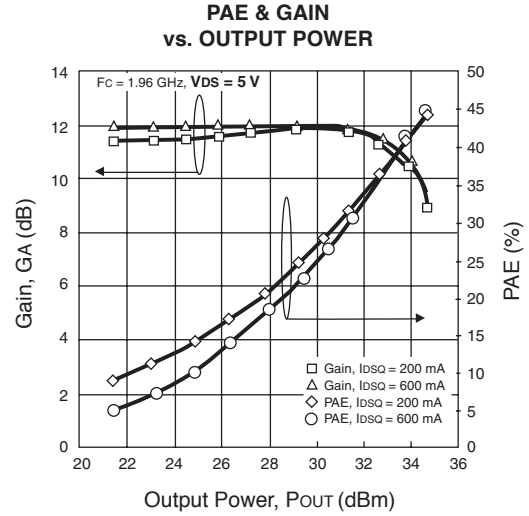
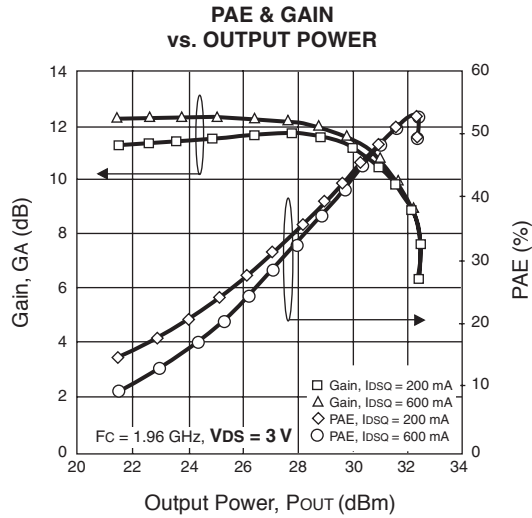

TYPICAL APPLICATION CIRCUIT PERFORMANCE at $V_{DS} = 3\text{ V}$ and $V_{DS} = 5\text{ V}$

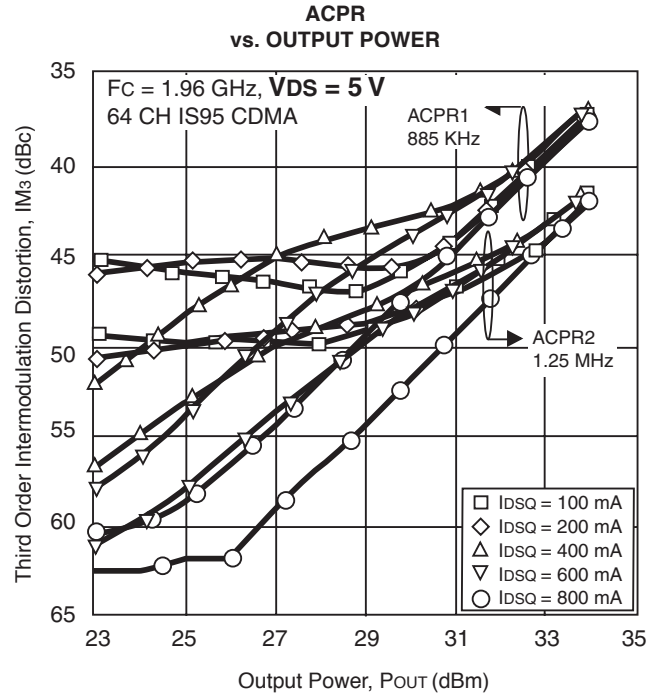
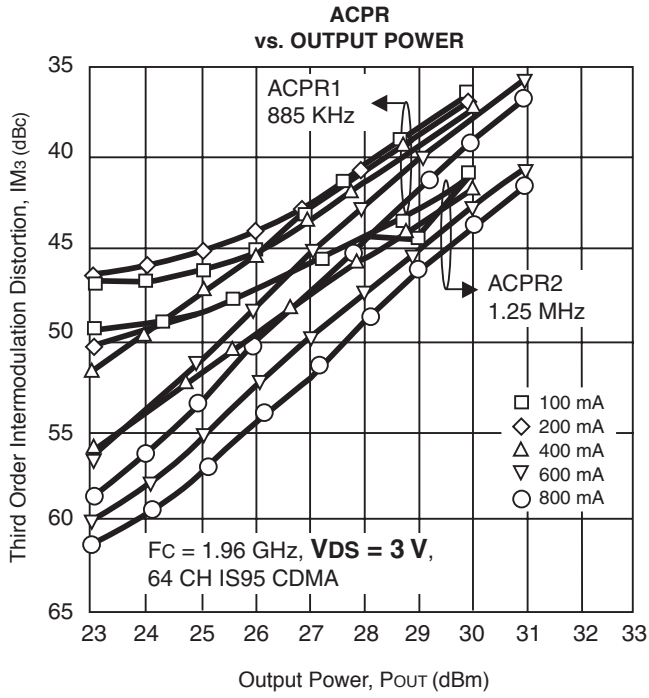

Subject: Compliance with EU Directives

CEL certifies, to its knowledge, that semiconductor and laser products detailed below are compliant with the requirements of European Union (EU) Directive 2002/95/EC Restriction on Use of Hazardous Substances in electrical and electronic equipment (RoHS) and the requirements of EU Directive 2003/11/EC Restriction on Penta and Octa BDE.

CEL Pb-free products have the same base part number with a suffix added. The suffix –A indicates that the device is Pb-free. The –AZ suffix is used to designate devices containing Pb which are exempted from the requirement of RoHS directive (*). In all cases the devices have Pb-free terminals. All devices with these suffixes meet the requirements of the RoHS directive.

This status is based on CEL’s understanding of the EU Directives and knowledge of the materials that go into its products as of the date of disclosure of this information.

Restricted Substance per RoHS	Concentration Limit per RoHS (values are not yet fixed)	Concentration contained in CEL devices	
		-A	-AZ
Lead (Pb)	< 1000 PPM	Not Detected	(*)
Mercury	< 1000 PPM	Not Detected	
Cadmium	< 100 PPM	Not Detected	
Hexavalent Chromium	< 1000 PPM	Not Detected	
PBB	< 1000 PPM	Not Detected	
PBDE	< 1000 PPM	Not Detected	

If you should have any additional questions regarding our devices and compliance to environmental standards, please do not hesitate to contact your local representative.

Important Information and Disclaimer: Information provided by CEL on its website or in other communications concerning the substance content of its products represents knowledge and belief as of the date that it is provided. CEL bases its knowledge and belief on information provided by third parties and makes no representation or warranty as to the accuracy of such information. Efforts are underway to better integrate information from third parties. CEL has taken and continues to take reasonable steps to provide representative and accurate information but may not have conducted destructive testing or chemical analysis on incoming materials and chemicals. CEL and CEL suppliers consider certain information to be proprietary, and thus CAS numbers and other limited information may not be available for release.

In no event shall CEL’s liability arising out of such information exceed the total purchase price of the CEL part(s) at issue sold by CEL to customer on an annual basis.

See CEL Terms and Conditions for additional clarification of warranties and liability.