

MC100LVELT22

3.3V Dual LVTTTL/LVCMOS to Differential LVPECL Translator

Description

The MC100LVELT22 is a dual LVTTTL/LVCMOS to differential LVPECL translator. Because LVPECL (Low Voltage Positive ECL) levels are used, only +3.3 V and ground are required. The small outline 8-lead package and the low skew, dual gate design of the LVELT22 makes it ideal for applications which require the translation of a clock and a data signal.

Features

- 350 ps Typical Propagation Delay
- <100 ps Output-to-Output Skew
- Flow Through Pinouts
- The 100 Series Contains Temperature Compensation
- LVPECL Operating Range: $V_{CC} = 3.0\text{ V to }3.8\text{ V}$ with $GND = 0\text{ V}$
- When Unused TTL Input is left Open, Q Output will Default High
- Pb-Free Packages are Available



ON Semiconductor®

<http://onsemi.com>

MARKING DIAGRAMS*

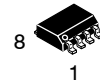

SOIC-8
D SUFFIX
CASE 751

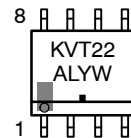

TSSOP-8
DT SUFFIX
CASE 948R

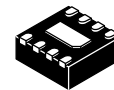
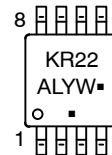

DFN8
MN SUFFIX
CASE 506AA



A = Assembly Location
L = Wafer Lot
Y = Year
W = Work Week
M̄ = Date Code
▪ = Pb-Free Package

(Note: Microdot may be in either location)
*For additional marking information, refer to Application Note AND8002/D.

ORDERING INFORMATION

See detailed ordering and shipping information in the package dimensions section on page 4 of this data sheet.

MC100LVELT22

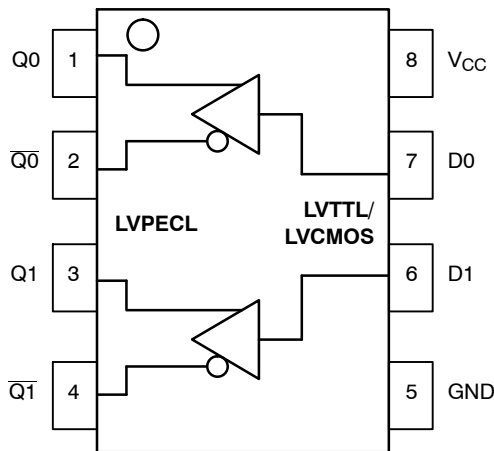

Table 1. PIN DESCRIPTION

PIN	FUNCTION
Qn, \overline{Qn}	LVPECL Differential Outputs
D0, D1	LVTTTL/LVCMOS Inputs
V _{CC}	Positive Supply
GND	Ground
EP	(DFN8 only) Thermal exposed pad must be connected to a sufficient thermal conduit. Electrically connect to the most negative supply (GND) or leave unconnected, floating open.

Figure 1. 8-Lead Pinout (Top View) and Logic Diagram

EP

Table 2. ATTRIBUTES

Characteristics	Value
Internal Input Pulldown Resistor	N/A
Internal Input Pullup Resistor	N/A
ESD Protection	Human Body Model Machine Model
	> 4 kV > 200 V
Moisture Sensitivity, Indefinite Time Out of Drypack (Note 1)	Level 1
Flammability Rating	Oxygen Index: 28 to 34
	UL 94 V-0 @ 0.125 in
Transistor Count	164
Meets or exceeds JEDEC Spec EIA/JESD78 IC Latchup Test	

1. For additional information, see Application Note AND8003/D.

Table 3. MAXIMUM RATINGS

Symbol	Parameter	Condition 1	Condition 2	Rating	Unit
V _{CC}	Positive Power Supply	GND = 0 V		7	V
V _I	Input Voltage	GND = 0 V	V _I ≤ V _{CC}	7	V
I _{out}	Output Current	Continuous		50	mA
		Surge		100	mA
T _A	Operating Temperature Range			-40 to +85	°C
T _{stg}	Storage Temperature Range			-65 to +150	°C
θ _{JA}	Thermal Resistance (Junction-to-Ambient)	0 lfpm 500 lfpm	SO-8 SO-8	190 130	°C/W °C/W
θ _{JC}	Thermal Resistance (Junction-to-Case)	std bd	SO-8	41 to 44 ± 5%	°C/W
θ _{JA}	Thermal Resistance (Junction-to-Ambient)	0 lfpm 500 lfpm	TSSOP-8 TSSOP-8	185 140	°C/W °C/W
θ _{JC}	Thermal Resistance (Junction-to-Case)	std bd	TSSOP-8	41 to 44 ± 5%	°C/W
θ _{JA}	Thermal Resistance (Junction-to-Ambient)	0 lfpm 500 lfpm	DFN8 DFN8	129 84	°C/W °C/W
T _{sol}	Wave Solder	Pb Pb-Free	<2 to 3 sec @ 248°C <2 to 3 sec @ 260°C	265 265	°C
θ _{JC}	Thermal Resistance (Junction-to-Case)	(Note 2)	DFN8	35 to 40	°C/W

Stresses exceeding Maximum Ratings may damage the device. Maximum Ratings are stress ratings only. Functional operation above the Recommended Operating Conditions is not implied. Extended exposure to stresses above the Recommended Operating Conditions may affect device reliability.

2. JEDEC standard multilayer board – 2S2P (2 signal, 2 power)

MC100LVELT22

Table 4. LVPECL DC CHARACTERISTICS $V_{CC} = 3.3\text{ V}$; $GND = 0.0\text{ V}$ (Note 3)

Symbol	Characteristic	-40°C			25°C			85°C			Unit
		Min	Typ	Max	Min	Typ	Max	Min	Typ	Max	
I_{CC}	Power Supply Current			28			28			29	mA
V_{OH}	Output HIGH Voltage (Note 4)	2275		2420	2275		2420	2275		2420	mV
V_{OL}	Output LOW Voltage (Note 4)	1490		1680	1490		1680	1490		1680	mV

NOTE: Device will meet the specifications after thermal equilibrium has been established when mounted in a test socket or printed circuit board with maintained transverse airflow greater than 500 lfpm. Electrical parameters are guaranteed only over the declared operating temperature range. Functional operation of the device exceeding these conditions is not implied. Device specification limit values are applied individually under normal operating conditions and not valid simultaneously.

- Output parameters vary 1:1 with V_{CC} . V_{CC} can vary $\pm 0.15\text{ V}$.
- Outputs are terminated through a 50 ohm resistor to $V_{CC}-2$ volts.

Table 5. LVTTTL/LVCMOS INPUT DC CHARACTERISTICS $V_{CC} = 3.3\text{ V}$; $T_A = -40^\circ\text{C}$ to 85°C (Note 5)

Symbol	Characteristic	Min	Typ	Max	Unit	Condition
I_{IH}	Input HIGH Current			20	μA	$V_{IN} = 2.7\text{ V}$
I_{IHH}	Input HIGH Current			100	μA	$V_{IN} = V_{CC}$
I_{IL}	Input LOW Current			-0.2	mA	$V_{IN} = 0.5\text{ V}$
V_{IK}				-1.2	V	$I_{IN} = -18\text{ mA}$
V_{IH}	Input HIGH Voltage	2.0			V	
V_{IL}	Input LOW Voltage			0.8	V	

NOTE: Device will meet the specifications after thermal equilibrium has been established when mounted in a test socket or printed circuit board with maintained transverse airflow greater than 500 lfpm. Electrical parameters are guaranteed only over the declared operating temperature range. Functional operation of the device exceeding these conditions is not implied. Device specification limit values are applied individually under normal operating conditions and not valid simultaneously.

- V_{CC} can vary $\pm 0.15\text{ V}$.

Table 6. AC CHARACTERISTICS $V_{CC} = 3.3\text{ V}$; $GND = 0.0\text{ V}$ (Note 6)

Symbol	Characteristic	-40°C			25°C			85°C			Unit
		Min	Typ	Max	Min	Typ	Max	Min	Typ	Max	
f_{max}	Maximum Toggle Frequency					350					MHz
t_{PLH}	Propagation Delay (Note 7)	200	350	600	200	350	600	200	350	600	ps
t_{skew}	Skew Output-to-Output Part-to-Part		30	100 400		30	100 400		30	100 400	ps
t_{JITTER}	Random Clock Jitter (RMS)					1.6					ps
t_r/t_f	Output Rise/Fall Time (20-80%)	200		550	200		500	200		500	ps

NOTE: Device will meet the specifications after thermal equilibrium has been established when mounted in a test socket or printed circuit board with maintained transverse airflow greater than 500 lfpm. Electrical parameters are guaranteed only over the declared operating temperature range. Functional operation of the device exceeding these conditions is not implied. Device specification limit values are applied individually under normal operating conditions and not valid simultaneously.

- V_{CC} can vary $\pm 0.15\text{ V}$.
- Specifications for standard TTL input signal.

MC100LVELT22

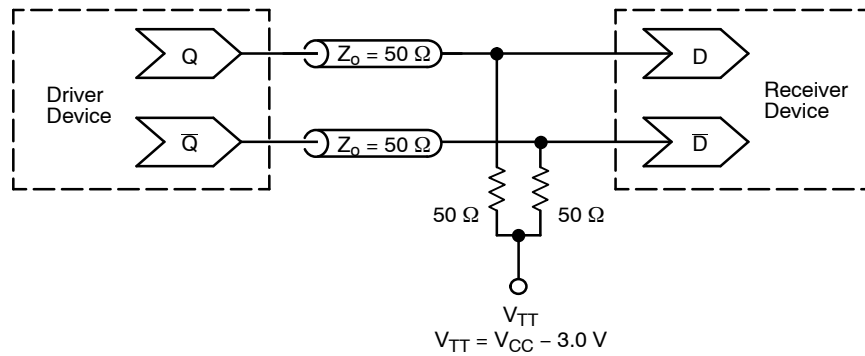

Figure 1. Typical Termination for Output Driver and Device Evaluation
(See Application Note AND8020/D – Termination of ECL Logic Devices.)

ORDERING INFORMATION

Device	Package	Shipping [†]
MC100LVELT22D	SOIC-8	98 Units / Rail
MC100LVELT22DG	SOIC-8 (Pb-Free)	98 Units / Rail
MC100LVELT22DR2	SOIC-8	2500 / Tape & Reel
MC100LVELT22DR2G	SOIC-8 (Pb-Free)	2500 / Tape & Reel
MC100LVELT22DT	TSSOP-8	100 Units / Rail
MC100LVELT22DTG	TSSOP-8 (Pb-Free)	100 Units / Rail
MC100LVELT22DTR2	TSSOP-8	2500 / Tape & Reel
MC100LVELT22DTR2G	TSSOP-8 (Pb-Free)	2500 / Tape & Reel
MC100LVELT22MNR4	DFN8	1000 / Tape & Reel
MC100LVELT22MNRG	DFN8 (Pb-Free)	1000 / Tape & Reel

[†]For information on tape and reel specifications, including part orientation and tape sizes, please refer to our Tape and Reel Packaging Specifications Brochure, BRD8011/D.

Resource Reference of Application Notes

- AN1405/D** – ECL Clock Distribution Techniques
- AN1406/D** – Designing with PECL (ECL at +5.0 V)
- AN1503/D** – ECLinPS™ I/O SPICE Modeling Kit
- AN1504/D** – Metastability and the ECLinPS Family
- AN1568/D** – Interfacing Between LVDS and ECL
- AN1672/D** – The ECL Translator Guide
- AND8001/D** – Odd Number Counters Design
- AND8002/D** – Marking and Date Codes
- AND8020/D** – Termination of ECL Logic Devices
- AND8066/D** – Interfacing with ECLinPS
- AND8090/D** – AC Characteristics of ECL Devices

MC100LVELT2

PACKAGE DIMENSIONS

SOIC-8 NB
CASE 751-07
ISSUE AH

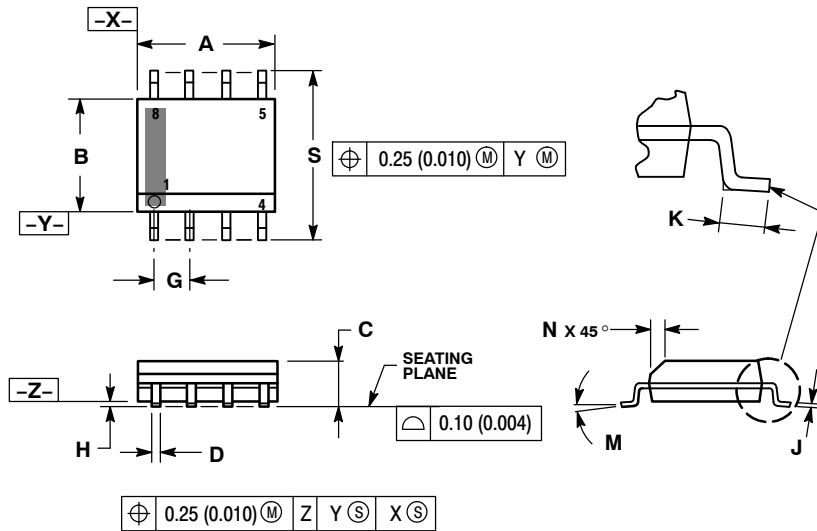

NOTES:

1. DIMENSIONING AND TOLERANCING PER ANSI Y14.5M, 1982.
2. CONTROLLING DIMENSION: MILLIMETER.
3. DIMENSION A AND B DO NOT INCLUDE MOLD PROTRUSION.
4. MAXIMUM MOLD PROTRUSION 0.15 (0.006) PER SIDE.
5. DIMENSION D DOES NOT INCLUDE DAMBAR PROTRUSION. ALLOWABLE DAMBAR PROTRUSION SHALL BE 0.127 (0.005) TOTAL IN EXCESS OF THE D DIMENSION AT MAXIMUM MATERIAL CONDITION.
6. 751-01 THRU 751-06 ARE OBSOLETE. NEW STANDARD IS 751-07.

DIM	MILLIMETERS		INCHES	
	MIN	MAX	MIN	MAX
A	4.80	5.00	0.189	0.197
B	3.80	4.00	0.150	0.157
C	1.35	1.75	0.053	0.069
D	0.33	0.51	0.013	0.020
G	1.27 BSC		0.050 BSC	
H	0.10	0.25	0.004	0.010
J	0.19	0.25	0.007	0.010
K	0.40	1.27	0.016	0.050
M	0°	8°	0°	8°
N	0.25	0.50	0.010	0.020
S	5.80	6.20	0.228	0.244

SOLDERING FOOTPRINT*

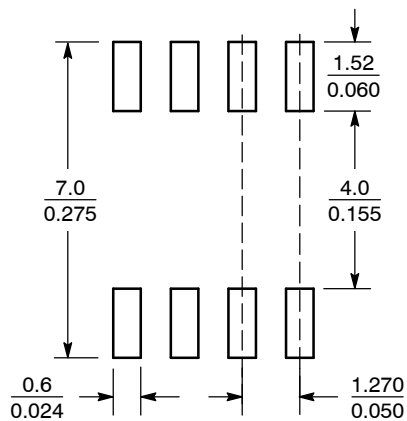

SCALE 6:1 $\left(\frac{\text{mm}}{\text{inches}}\right)$

*For additional information on our Pb-Free strategy and soldering details, please download the ON Semiconductor Soldering and Mounting Techniques Reference Manual, SOLDERRM/D.

MC100LVELT2

PACKAGE DIMENSIONS

TSSOP-8
DT SUFFIX
PLASTIC TSSOP PACKAGE
CASE 948R-02
ISSUE A

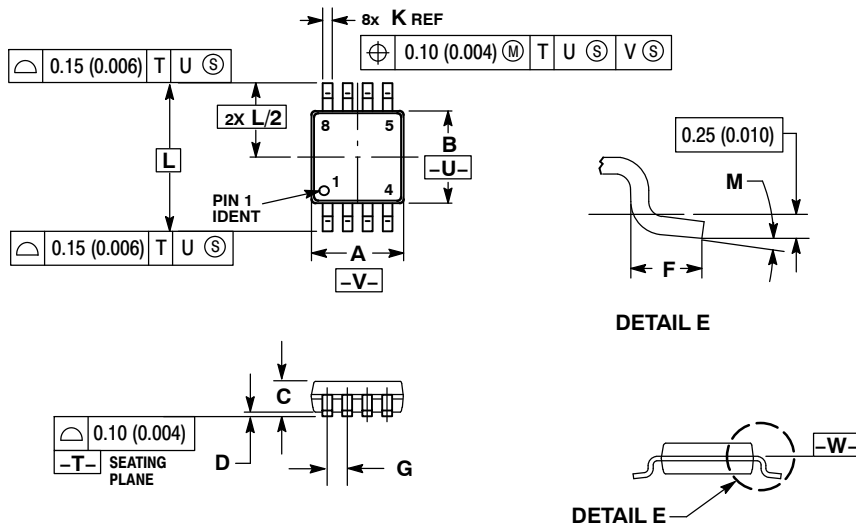

NOTES:

1. DIMENSIONING AND TOLERANCING PER ANSI Y14.5M, 1982.
2. CONTROLLING DIMENSION: MILLIMETER.
3. DIMENSION A DOES NOT INCLUDE MOLD FLASH. PROTRUSIONS OR GATE BURRS. MOLD FLASH OR GATE BURRS SHALL NOT EXCEED 0.15 (0.006) PER SIDE.
4. DIMENSION B DOES NOT INCLUDE INTERLEAD FLASH OR PROTRUSION. INTERLEAD FLASH OR PROTRUSION SHALL NOT EXCEED 0.25 (0.010) PER SIDE.
5. TERMINAL NUMBERS ARE SHOWN FOR REFERENCE ONLY.
6. DIMENSION A AND B ARE TO BE DETERMINED AT DATUM PLANE -W-.

DIM	MILLIMETERS		INCHES	
	MIN	MAX	MIN	MAX
A	2.90	3.10	0.114	0.122
B	2.90	3.10	0.114	0.122
C	0.80	1.10	0.031	0.043
D	0.05	0.15	0.002	0.006
F	0.40	0.70	0.016	0.028
G	0.65 BSC		0.026 BSC	
K	0.25	0.40	0.010	0.016
L	4.90 BSC		0.193 BSC	
M	0°	6°	0°	6°

MC100LVELT22

PACKAGE DIMENSIONS

DFN8
CASE 506AA-01
ISSUE D

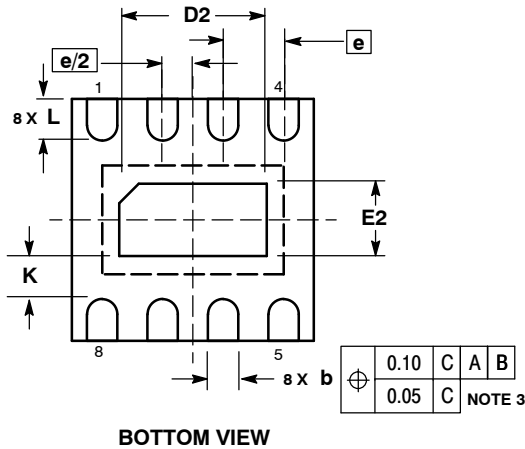
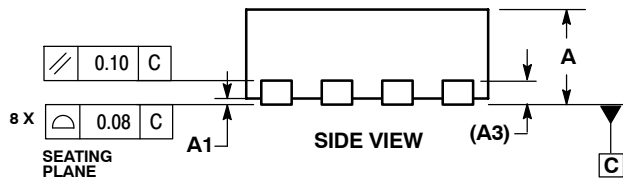
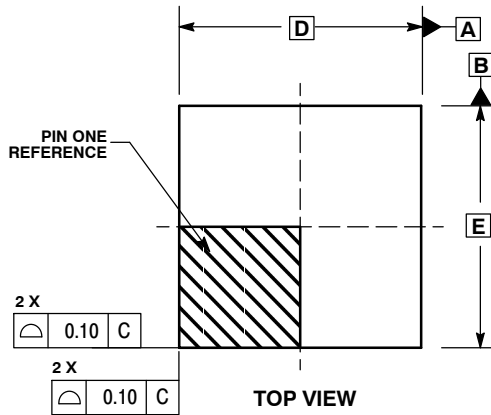

NOTES:

1. DIMENSIONING AND TOLERANCING PER ASME Y14.5M, 1994 .
2. CONTROLLING DIMENSION: MILLIMETERS.
3. DIMENSION b APPLIES TO PLATED TERMINAL AND IS MEASURED BETWEEN 0.25 AND 0.30 MM FROM TERMINAL
4. COPLANARITY APPLIES TO THE EXPOSED PAD AS WELL AS THE TERMINALS.

DIM	MILLIMETERS	
	MIN	MAX
A	0.80	1.00
A1	0.00	0.05
A3	0.20 REF	
b	0.20	0.30
D	2.00 BSC	
D2	1.10	1.30
E	2.00 BSC	
E2	0.70	0.90
e	0.50 BSC	
K	0.20	---
L	0.25	0.35

ECLinPS is a trademark of Semiconductor Components INdustries, LLC (SCILLC).

ON Semiconductor and  are registered trademarks of Semiconductor Components Industries, LLC (SCILLC). SCILLC reserves the right to make changes without further notice to any products herein. SCILLC makes no warranty, representation or guarantee regarding the suitability of its products for any particular purpose, nor does SCILLC assume any liability arising out of the application or use of any product or circuit, and specifically disclaims any and all liability, including without limitation special, consequential or incidental damages. "Typical" parameters which may be provided in SCILLC data sheets and/or specifications can and do vary in different applications and actual performance may vary over time. All operating parameters, including "Typicals" must be validated for each customer application by customer's technical experts. SCILLC does not convey any license under its patent rights nor the rights of others. SCILLC products are not designed, intended, or authorized for use as components in systems intended for surgical implant into the body, or other applications intended to support or sustain life, or for any other application in which the failure of the SCILLC product could create a situation where personal injury or death may occur. Should Buyer purchase or use SCILLC products for any such unintended or unauthorized application, Buyer shall indemnify and hold SCILLC and its officers, employees, subsidiaries, affiliates, and distributors harmless against all claims, costs, damages, and expenses, and reasonable attorney fees arising out of, directly or indirectly, any claim of personal injury or death associated with such unintended or unauthorized use, even if such claim alleges that SCILLC was negligent regarding the design or manufacture of the part. SCILLC is an Equal Opportunity/Affirmative Action Employer. This literature is subject to all applicable copyright laws and is not for resale in any manner.

PUBLICATION ORDERING INFORMATION

LITERATURE FULFILLMENT:
Literature Distribution Center for ON Semiconductor
P.O. Box 5163, Denver, Colorado 80217 USA
Phone: 303-675-2175 or 800-344-3860 Toll Free USA/Canada
Fax: 303-675-2176 or 800-344-3867 Toll Free USA/Canada
Email: orderlit@onsemi.com

N. American Technical Support: 800-282-9855 Toll Free
USA/Canada
Europe, Middle East and Africa Technical Support:
Phone: 421 33 790 2910
Japan Customer Focus Center
Phone: 81-3-5773-3850

ON Semiconductor Website: www.onsemi.com
Order Literature: <http://www.onsemi.com/orderlit>

For additional information, please contact your local Sales Representative

MC100LVELT22/D