

Silicon PIN Diode

- High voltage current controlled RF resistor for RF attenuator and switches
- Frequency range above 1 MHz up to 6 GHz
- Very low capacitance at zero volt reverse bias at frequencies above 1 GHz (typ. 0.17 pF)
- Low forward resistance (typ. 2.1 Ω @ 10 mA)
- Very low signal distortion
- Pb-free (RoHS compliant) package ¹⁾
- Qualified according AEC Q101

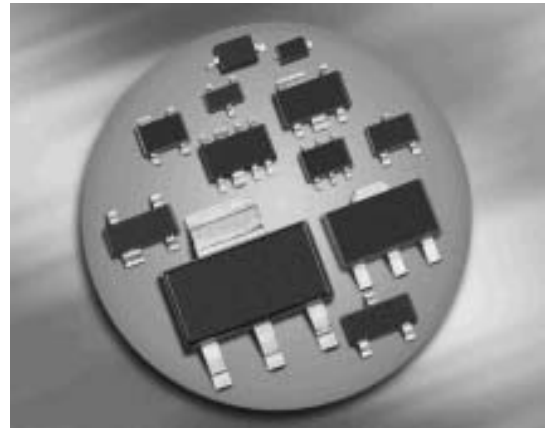

BAR64-02LRH
BAR64-02V
BAR64-03W

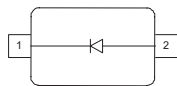

BAR64-04
BAR64-04W

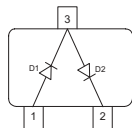

BAR64-05
BAR64-05W

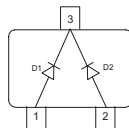

BAR64-06
BAR64-06W

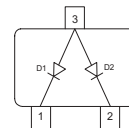

BAR64-07

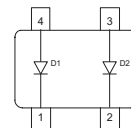

Type	Package	Configuration	L_S (nH)	Marking
BAR64-02LRH	TSLP-2-7	single, leadless	0.4	O
BAR64-02V	SC79	single	0.6	O
BAR64-03W	SOD323	single	1.8	2 blue
BAR64-04	SOT23	series	1.8	PPs
BAR64-04W	SOT323	series	1.4	PPs
BAR64-05	SOT23	common cathode	1.8	PRs
BAR64-05W	SOT323	common cathode	1.4	PRs
BAR64-06	SOT23	common anode	1.8	PSs
BAR64-06W	SOT323	common anode	1.4	PSs
BAR64-07	SOT143	parallel pair	2	PTs

¹Pb-containing package may be available upon special request

Maximum Ratings at $T_A = 25^\circ\text{C}$, unless otherwise specified

Parameter	Symbol	Value	Unit
Diode reverse voltage	V_R	150	V
Forward current	I_F	100	mA
Total power dissipation BAR64-02LRH, $T_S \leq 135^\circ\text{C}$ BAR64-02V, $T_S \leq 125^\circ\text{C}$ BAR64-03W, BAR64-07, $T_S \leq 25^\circ\text{C}$ BAR64-04, -05, -06, $T_S \leq 65^\circ\text{C}$ BAR64-04W, -05W, -06W, $T_S \leq 115^\circ\text{C}$	P_{tot}	250 250 250 250 250	mW
Junction temperature	T_j	150	°C
Operating temperature range	T_{op}	-55 ... 125	
Storage temperature	T_{stg}	-55 ... 150	

Thermal Resistance

Parameter	Symbol	Value	Unit
Junction - soldering point ¹⁾ BAR64-02LRH BAR64-02V, -04W, -05W, -06W BAR64-03W BAR64-04, -05, -06 BAR64-07	R_{thJS}	≤ 60 ≤ 140 ≤ 370 ≤ 340 ≤ 290	

Electrical Characteristics at $T_A = 25^\circ\text{C}$, unless otherwise specified

Parameter	Symbol	Values			Unit
		min.	typ.	max.	
Breakdown voltage $I_{(\text{BR})} = 5 \mu\text{A}$	$V_{(\text{BR})}$	150	-	-	V
Forward voltage $I_F = 50 \text{ mA}$	V_F	-	-	1.1	

¹For calculation of R_{thJA} please refer to Application Note Thermal Resistance

Electrical Characteristics at $T_A = 25^\circ\text{C}$, unless otherwise specified

Parameter	Symbol	Values			Unit
		min.	typ.	max.	
AC Characteristics					
Diode capacitance $V_R = 20\text{ V}$, $f = 1\text{ MHz}$ $V_R = 0\text{ V}$, $f = 100\text{ MHz}$ $V_R = 0\text{ V}$, $f = 1\dots 1.8\text{ GHz}$, BAR64-02LRH $V_R = 0\text{ V}$, $f = 1\dots 1.8\text{ GHz}$, all other	C_T	-	0.23	0.35	pF
Reverse parallel resistance $V_R = 0\text{ V}$, $f = 100\text{ MHz}$ $V_R = 0\text{ V}$, $f = 1\text{ GHz}$ $V_R = 0\text{ V}$, $f = 1.8\text{ GHz}$	R_P	-	10	-	k Ω
Forward resistance $I_F = 1\text{ mA}$, $f = 100\text{ MHz}$ $I_F = 10\text{ mA}$, $f = 100\text{ MHz}$ $I_F = 100\text{ mA}$, $f = 100\text{ MHz}$	r_f	-	12.5	20	Ω
Charge carrier life time $I_F = 10\text{ mA}$, $I_R = 6\text{ mA}$, measured at $I_R = 3\text{ mA}$, $R_L = 100\ \Omega$	τ_{rr}	-	1550	-	ns
I-region width	W_I	-	50	-	μm
Insertion loss ¹⁾ $I_F = 3\text{ mA}$, $f = 1.8\text{ GHz}$ $I_F = 5\text{ mA}$, $f = 1.8\text{ GHz}$ $I_F = 10\text{ mA}$, $f = 1.8\text{ GHz}$	I_L	-	0.32	-	dB
Isolation ¹⁾ $V_R = 0\text{ V}$, $f = 0.9\text{ GHz}$ $V_R = 0\text{ V}$, $f = 1.8\text{ GHz}$ $V_R = 0\text{ V}$, $f = 2.45\text{ GHz}$ $V_R = 0\text{ V}$, $f = 5.6\text{ GHz}$	I_{SO}	-	22	-	

¹BAR64-02LRH in series configuration, $Z = 50\ \Omega$

Diode capacitance $C_T = f(V_R)$

$f =$ Parameter

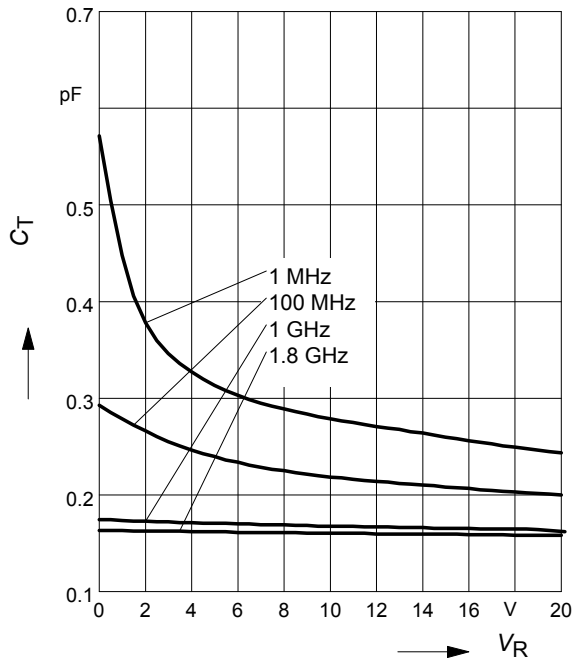

Reverse parallel resistance $R_p = f(V_R)$

$f =$ Parameter

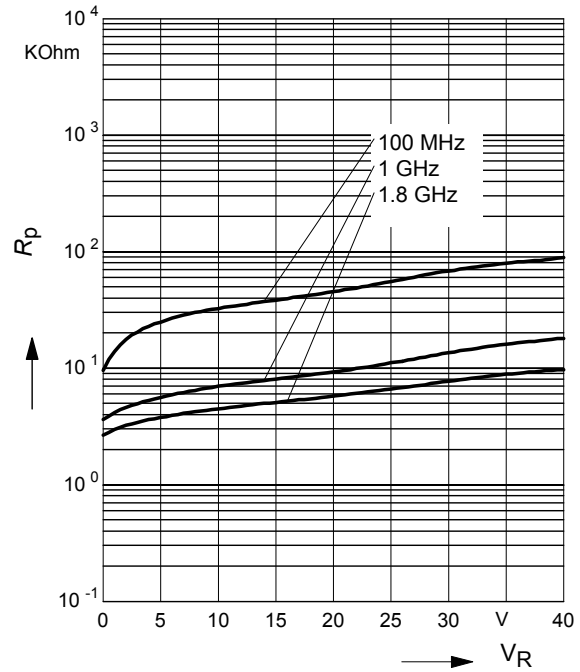

Forward resistance $r_f = f(I_F)$

$f = 100\text{MHz}$

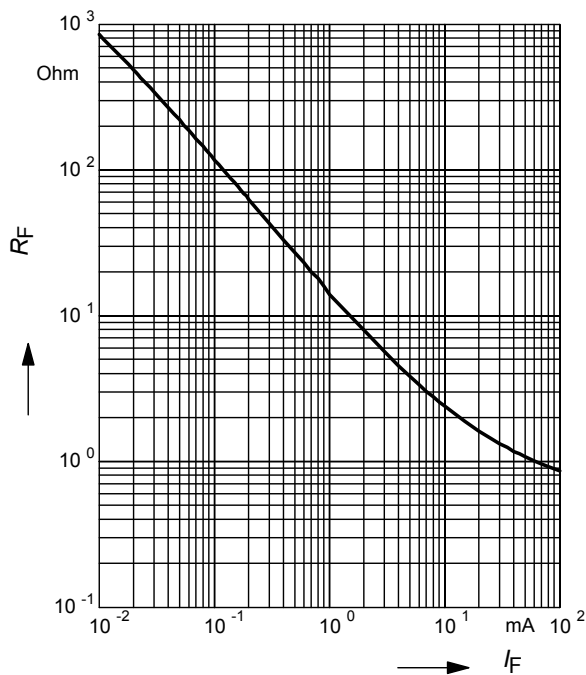

Forward current $I_F = f(V_F)$

$T_A =$ Parameter

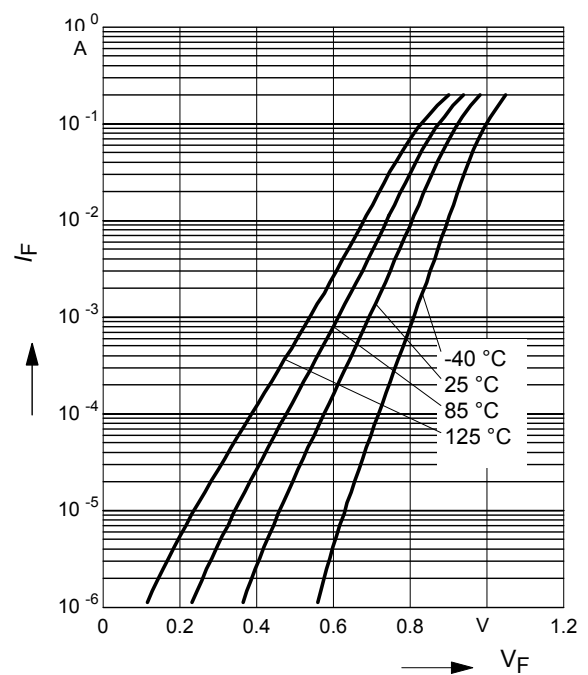

Intermodulation intercept point

$IP_3 = f(I_F)$; $f =$ Parameter

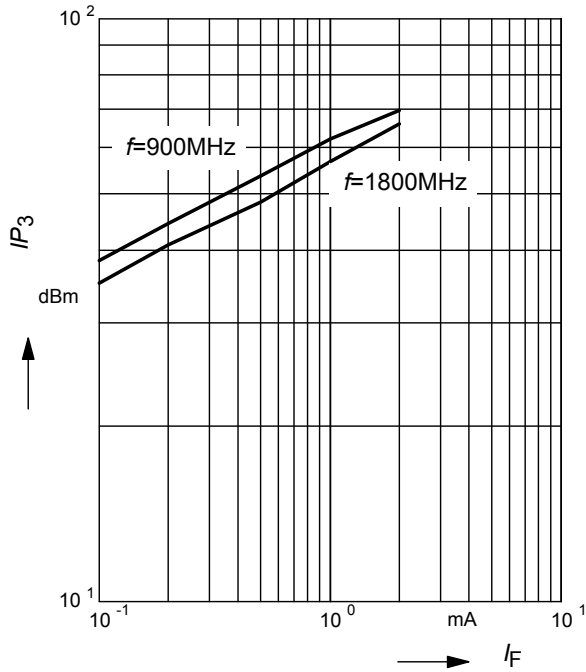

Forward current $I_F = f(T_S)$

BAR64-02LRH

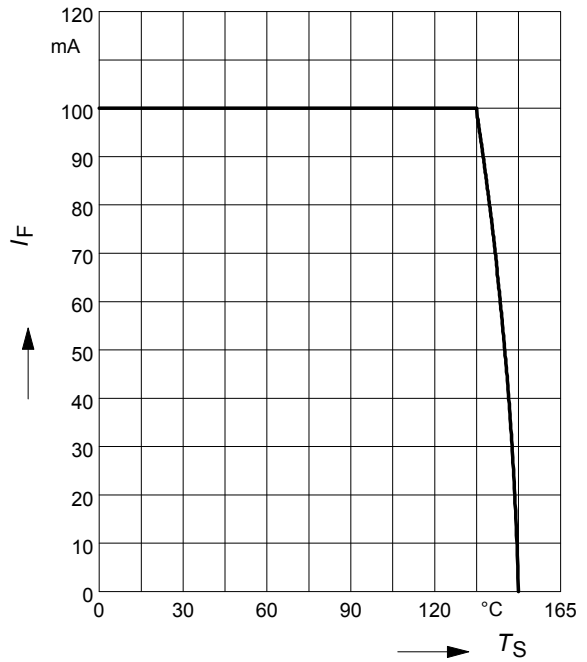

Forward current $I_F = f(T_S)$

BAR64-02V

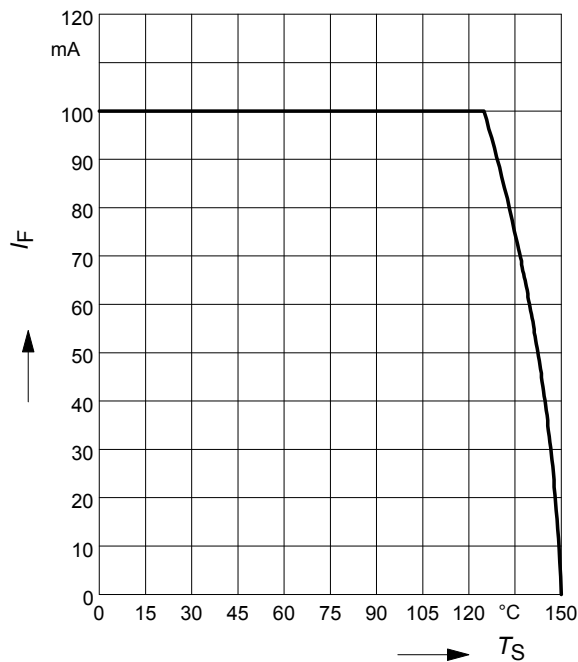

Forward current $I_F = f(T_S)$

BAR64-04, BAR64-05, BAR64-06

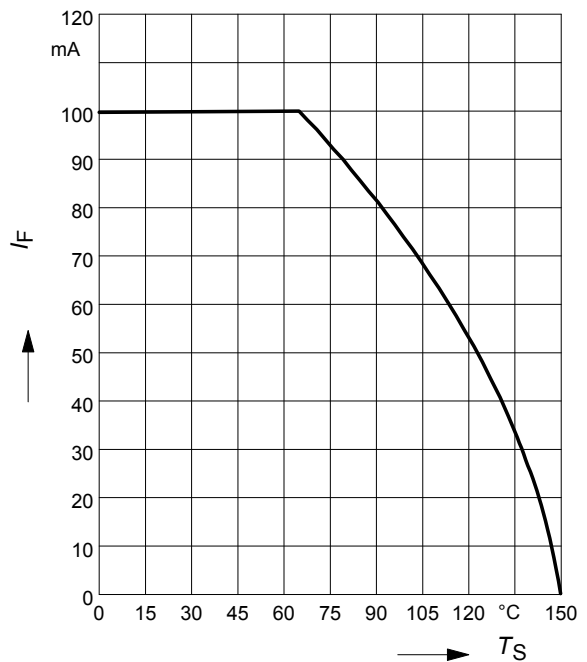

Forward current $I_F = f(T_S)$

BAR64-04W, BAR64-05W, BAR64-06W

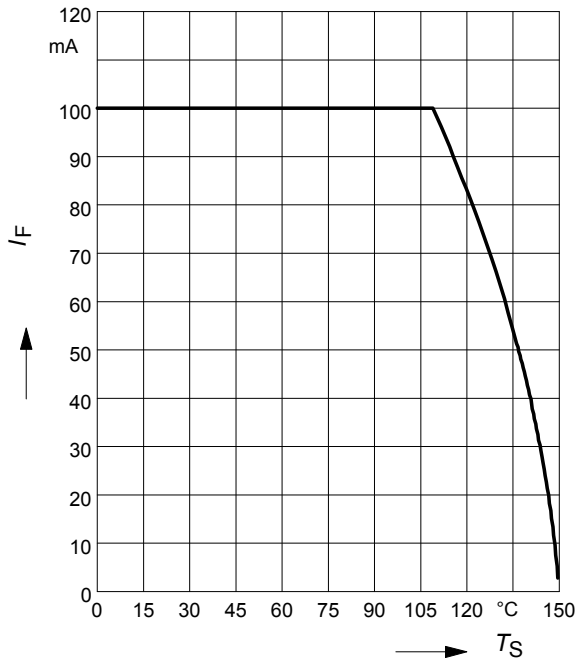

Permissible Puls Load $R_{thJS} = f(t_p)$

BAR64-02LRH

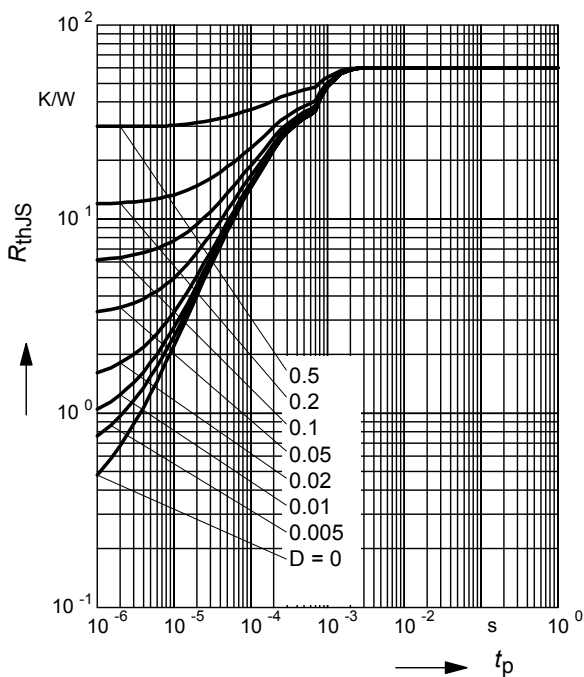

Permissible Pulse Load

$I_{Fmax} / I_{FDC} = f(t_p)$

BAR64-02LRH

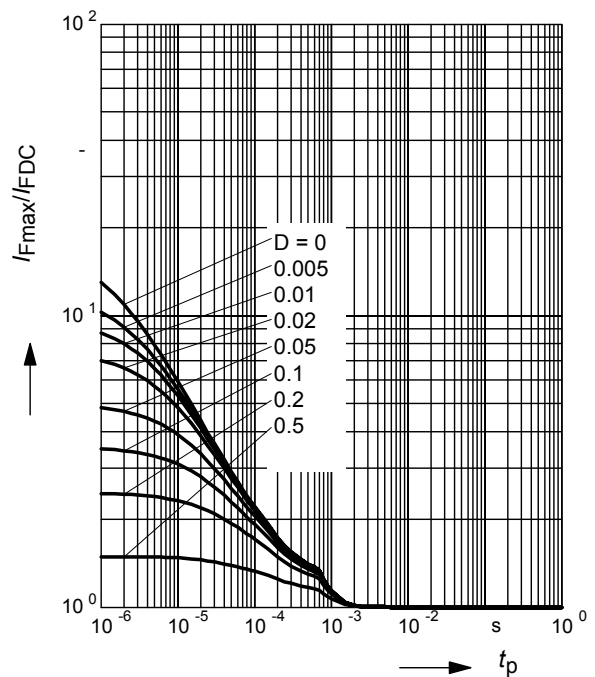

Permissible Puls Load $R_{thJS} = f(t_p)$

BAR64-02V

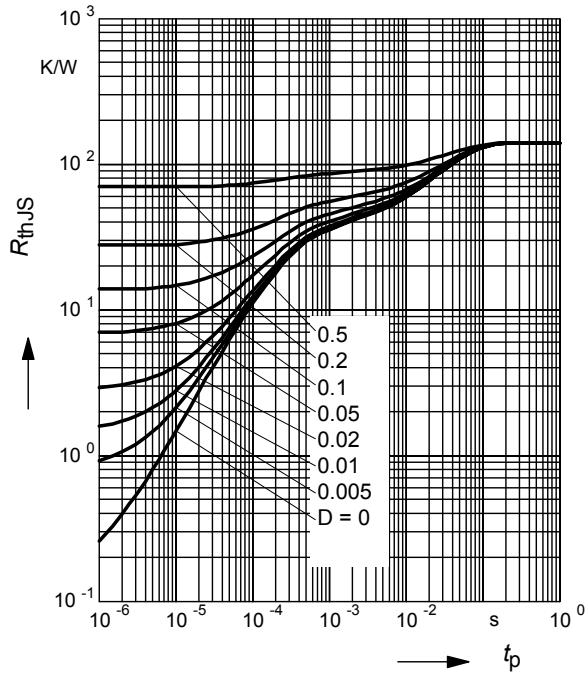

Permissible Pulse Load

$I_{Fmax} / I_{FDC} = f(t_p)$

BAR64-02V

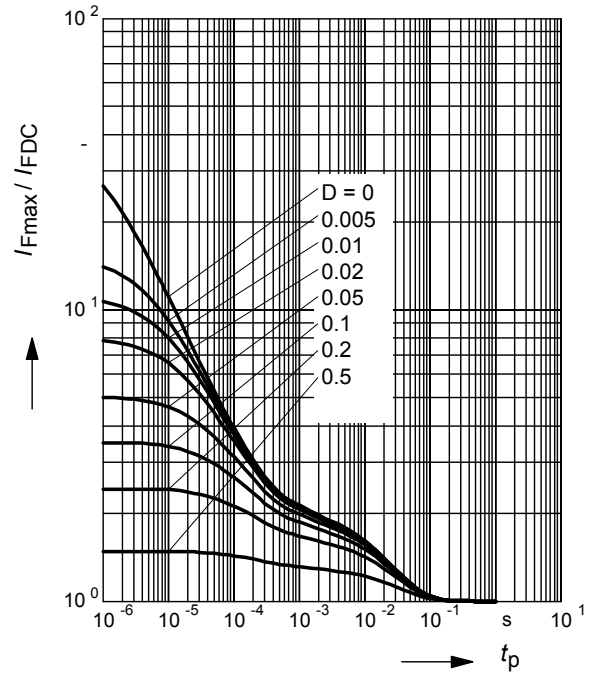

Permissible Puls Load $R_{thJS} = f(t_p)$

BAR64-04, BAR64-05, BAR64-06

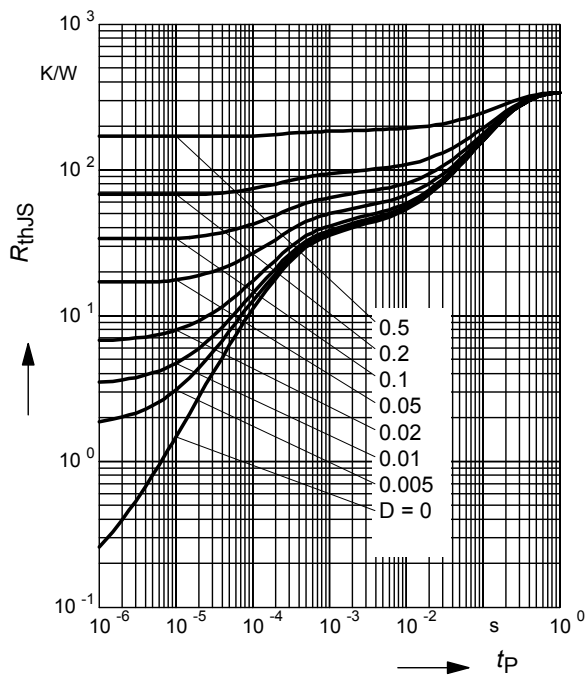

Permissible Pulse Load

$I_{Fmax} / I_{FDC} = f(t_p)$

BAR64-04, BAR64-05, BAR64-06

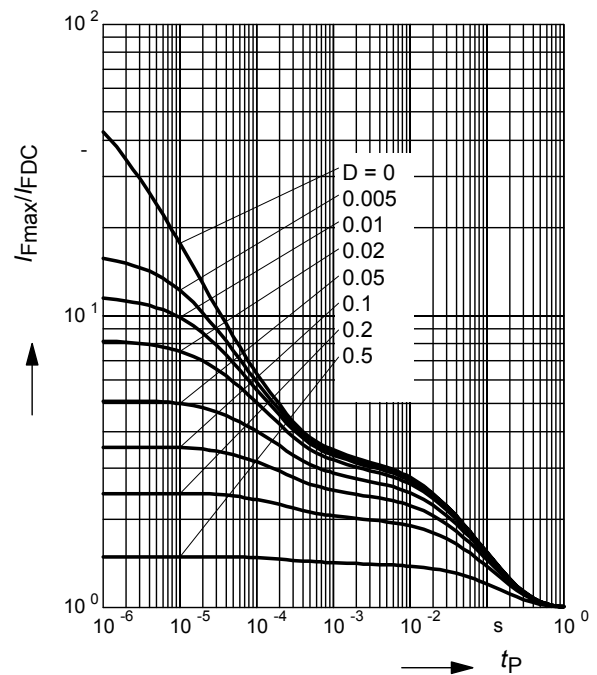

Permissible Puls Load $R_{thJS} = f(t_p)$
 BAR64-04W, BAR64-05W, BAR64-06W

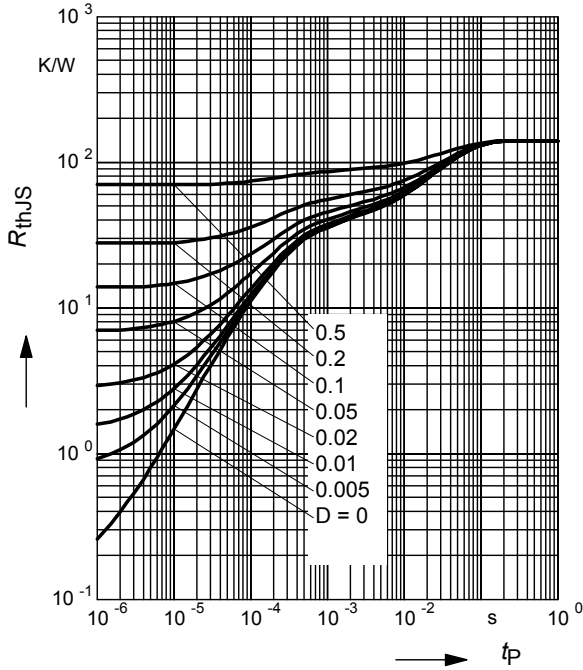

Permissible Pulse Load $I_{Fmax}/I_{FDC} = f(t_p)$
 BAR64-04W, BAR64-05W, BAR64-06W

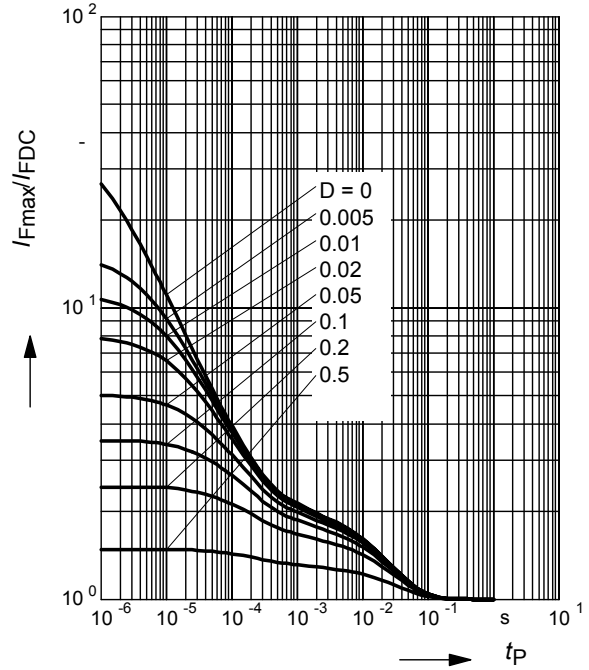

Insertion loss $I_L = -|S_{21}|^2 = f(f)$
 I_F = Parameter
 BAR64-02LRH in series configuration, $Z = 50\Omega$

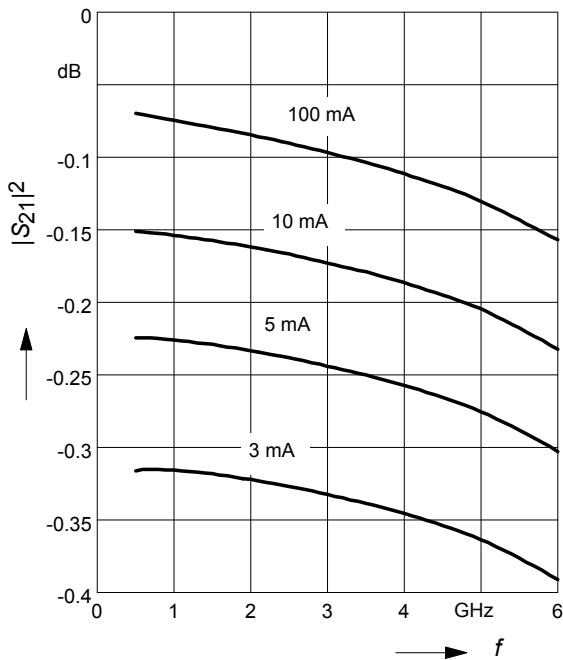

Isolation $I_{SO} = -|S_{21}|^2 = f(f)$
 V_R = Parameter
 BAR64-02LRH in series configuration, $Z = 50\Omega$

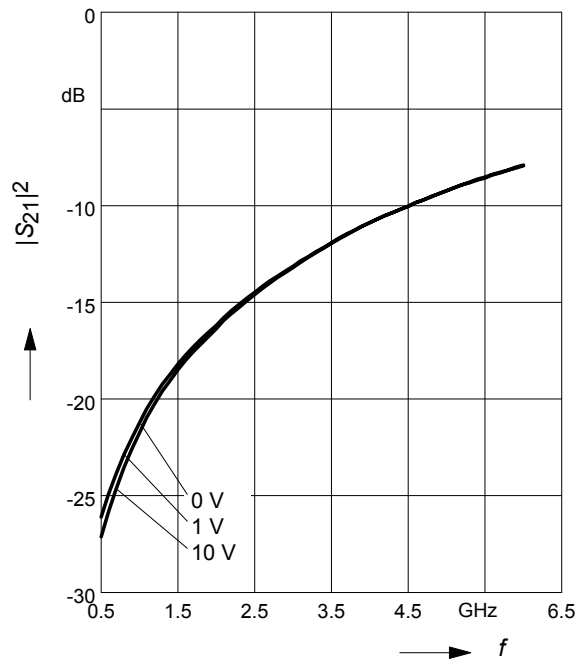

Package Outline

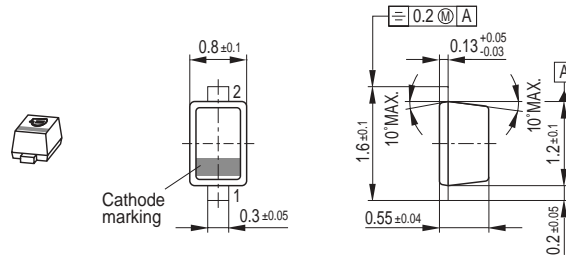

Foot Print



Marking Layout (Example)

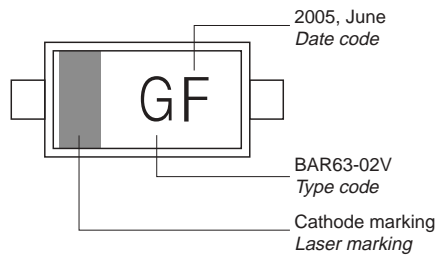

Standard Packing

Reel \varnothing 180 mm = 3.000 Pieces/Reel
 Reel \varnothing 180 mm = 8.000 Pieces/Reel (2 mm Pitch)
 Reel \varnothing 330 mm = 10.000 Pieces/Reel

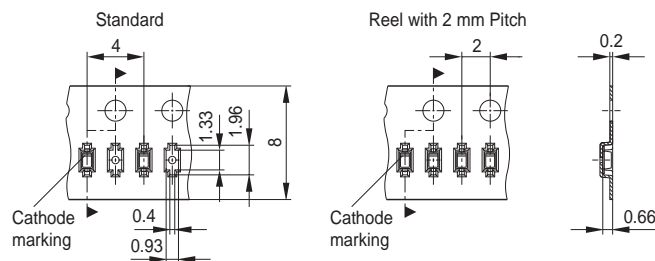

Date Code marking for discrete packages with one digit (SCD80, SC79, SC75¹⁾) CES-Code

Month	2003	2004	2005	2006	2007	2008	2009	2010	2011	2012	2013	2014
01	a	p	A	P	a	p	A	P	a	p	A	P
02	b	q	B	Q	b	q	B	Q	b	q	B	Q
03	c	r	C	R	c	r	C	R	c	r	C	R
04	d	s	D	S	d	s	D	S	d	s	D	S
05	e	t	E	T	e	t	E	T	e	t	E	T
06	f	u	F	U	f	u	F	U	f	u	F	U
07	g	v	G	V	g	v	G	V	g	v	G	V
08	h	x	H	X	h	x	H	X	h	x	H	X
09	j	y	J	Y	j	y	J	Y	j	y	J	Y
10	k	z	K	Z	k	z	K	Z	k	z	K	Z
11	l	2	L	4	l	2	L	4	l	2	L	4
12	n	3	N	5	n	3	N	5	n	3	N	5

1) New Marking Layout for SC75, implemented at October 2005.

Package Outline

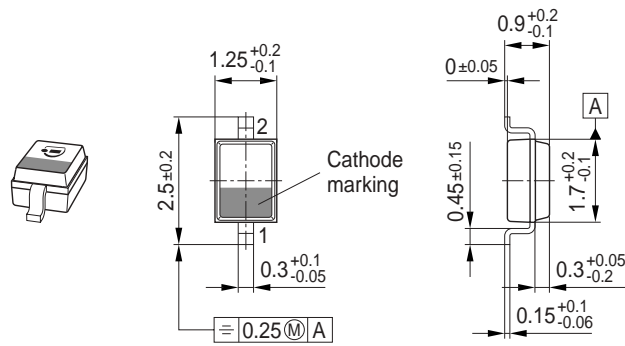

Foot Print

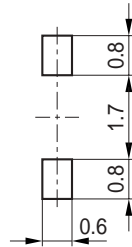

Marking Layout (Example)

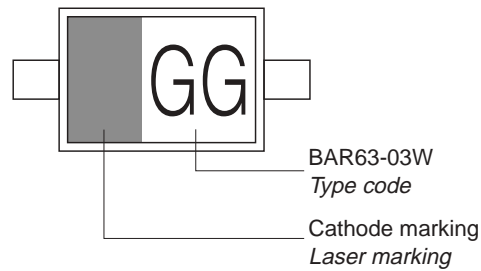

Standard Packing

Reel \varnothing 180 mm = 3.000 Pieces/Reel
 Reel \varnothing 330 mm = 10.000 Pieces/Reel

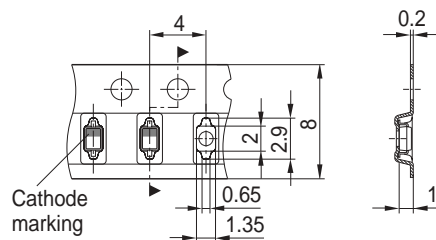

Package Outline

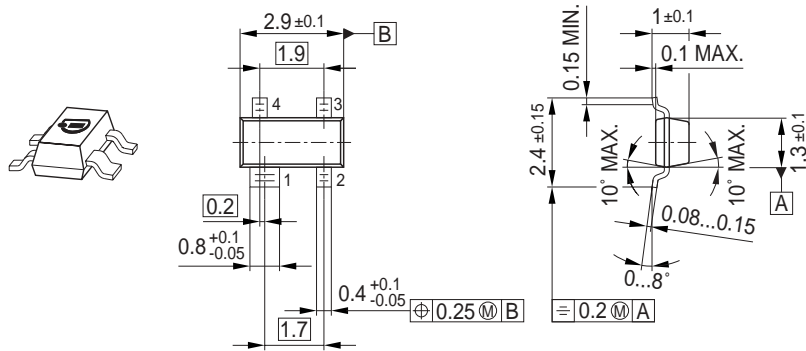

Foot Print

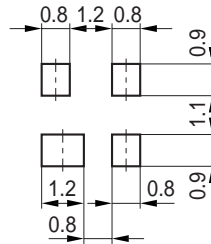

Marking Layout (Example)

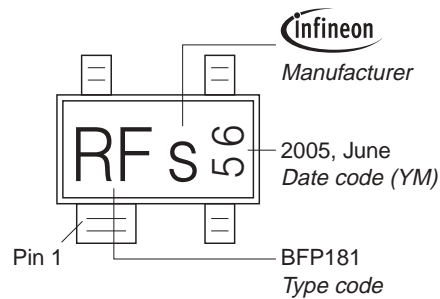

Standard Packing

Reel $\varnothing 180$ mm = 3.000 Pieces/Reel
 Reel $\varnothing 330$ mm = 10.000 Pieces/Reel

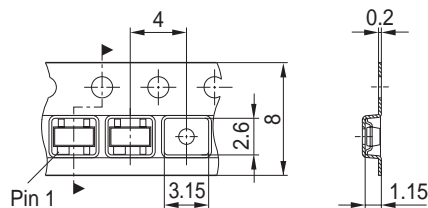

Package Outline

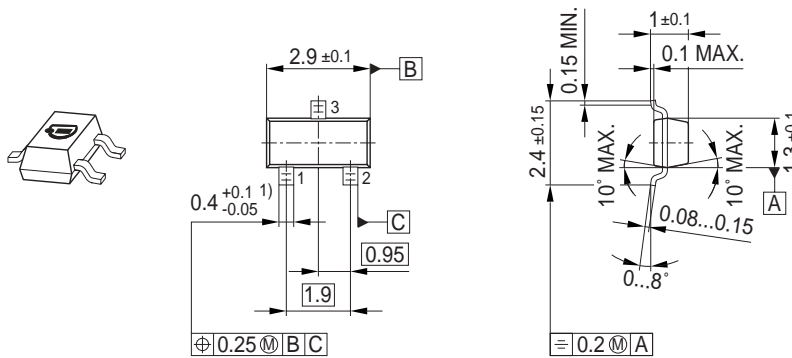

1) Lead width can be 0.6 max. in dambar area

Foot Print

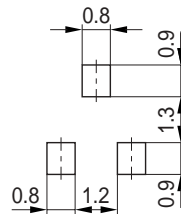

Marking Layout (Example)

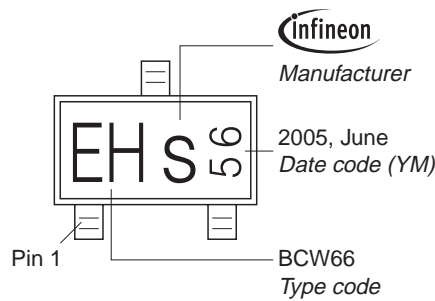

Standard Packing

Reel ø180 mm = 3.000 Pieces/Reel
 Reel ø330 mm = 10.000 Pieces/Reel

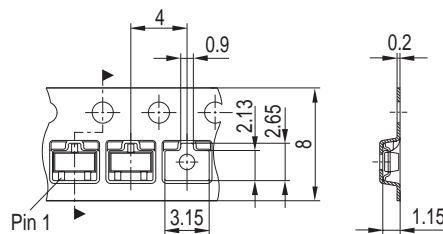

Package Outline

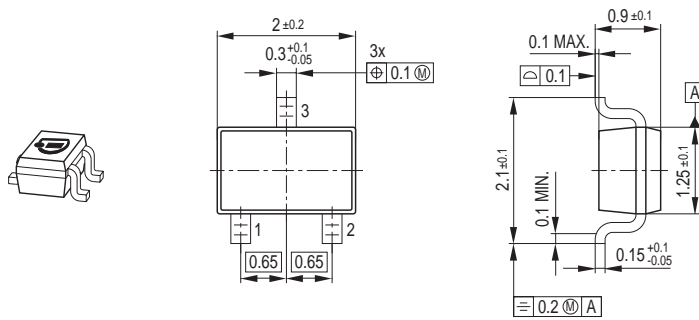

Foot Print

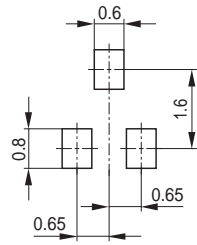

Marking Layout (Example)

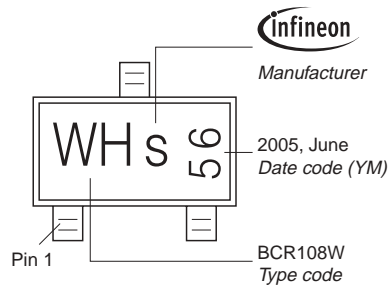

Standard Packing

Reel \varnothing 180 mm = 3.000 Pieces/Reel
 Reel \varnothing 330 mm = 10.000 Pieces/Reel

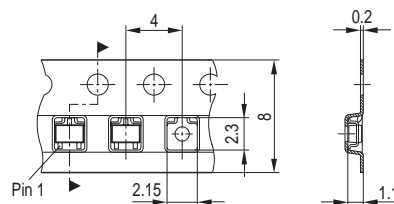

Package Outline

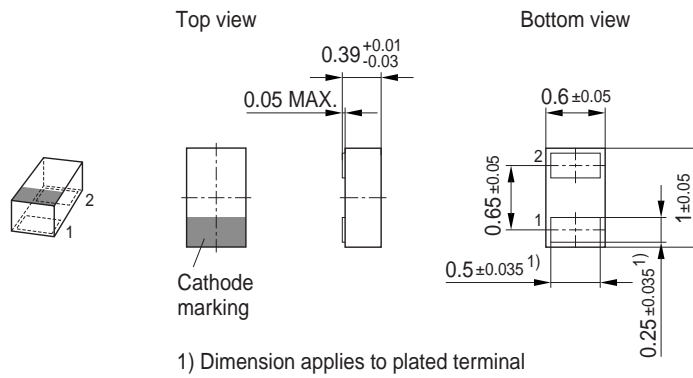

Foot Print

For board assembly information please refer to Infineon website "Packages"

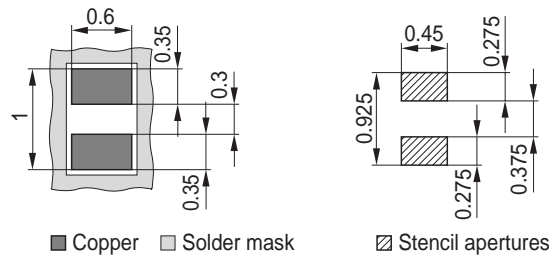

Marking Layout (Example)

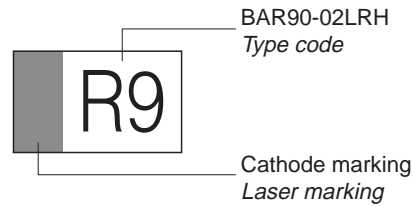

Standard Packing

Reel ø180 mm = 15.000 Pieces/Reel
Reel ø330 mm = 50.000 Pieces/Reel (optional)

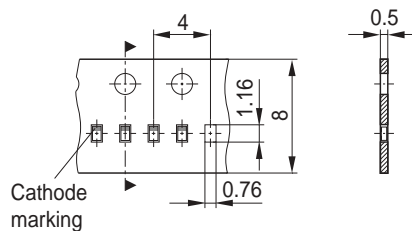

Edition 2006-02-01
Published by
Infineon Technologies AG
81726 München, Germany
© Infineon Technologies AG 2007.
All Rights Reserved.

Attention please!

The information given in this dokument shall in no event be regarded as a guarantee of conditions or characteristics ("Beschaffenhheitsgarantie"). With respect to any examples or hints given herein, any typical values stated herein and/or any information regarding the application of the device, Infineon Technologies hereby disclaims any and all warranties and liabilities of any kind, including without limitation warranties of non-infringement of intellectual property rights of any third party.

Information

For further information on technology, delivery terms and conditions and prices please contact your nearest Infineon Technologies Office (www.infineon.com).

Warnings

Due to technical requirements components may contain dangerous substances. For information on the types in question please contact your nearest Infineon Technologies Office.

Infineon Technologies Components may only be used in life-support devices or systems with the express written approval of Infineon Technologies, if a failure of such components can reasonably be expected to cause the failure of that life-support device or system, or to affect the safety or effectiveness of that device or system.

Life support devices or systems are intended to be implanted in the human body, or to support and/or maintain and sustain and/or protect human life. If they fail, it is reasonable to assume that the health of the user or other persons may be endangered.