

# Slotted Optical Switch

OPB355, OPB360, OPB370, OPB380, OPB390

OPB859, OPB860, OPB870, OPB880, OPB890

## Series



### Features:

- 0.125" (3.175 mm) slot width
- Choice of aperture (0.050" or 0.010" width)
- Choice of opaque or IR transmissive shell material
- Choice of mounting configurations
- Choice of lead spacing or wires

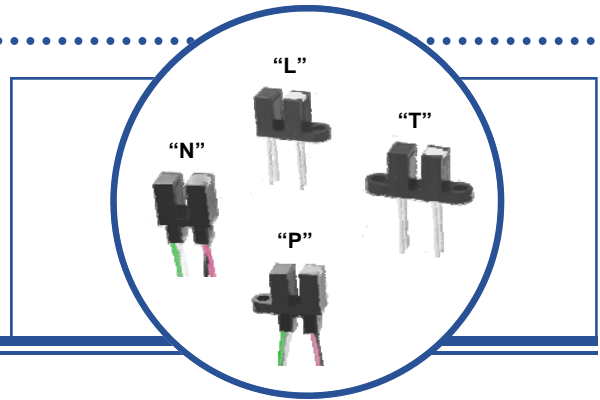

### Description:

Each device in this series provides the flexibility of a custom device from a standard product line. Building from a standard housing with a 0.125" (3.18 mm) wide slot, a user can choose aperture width, opaque or IR transmissive housing shell material, PCBoard lead spacing or wires and mounting tab configuration.

Housings are made from an opaque grade of injection-molded plastic to minimize sensitivity to both visible and near-infrared light. Discrete shells exposed on the parallel faces inside each device's throat are made from either IR transmissive plastic (for applications where dust protection is needed) or from opaque plastic with aperture openings (for applications that require maximum protection against ambient light).

Phototransistor sensor devices include the **OPB859, OPB360, OPB370, OPB380, OPB390, OPB860** and **OPB870**, while the **OPB355** provides a photodiode sensor. The photodiode sensor has a lower and more linear output-versus-light input than the phototransistor models.

The **OPB355, OPB360, OPB370, OPB859, OPB860** and **OPB870** are designed for direct connection to through hole PCBoards. The **OPB380, OPB390, OPB880** and **OPB890** have 26 AWG, UL approved wires connected directly to the device for remote sensing applications.

Custom electrical, wire and cabling and connectors are available. Contact your local representative or OPTEK for more information.

### Applications:

- Non-contact object sensing
- Assembly line automation
- Machine automation
- Equipment safety
- Machine safety

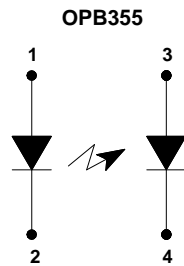

OPB360, OPB370, OPB380, OPB390  
OPB859  
OPB860, OPB870, OPB880, OPB890

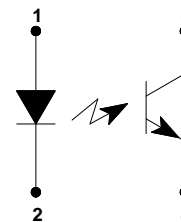

Wire Colors	
Color #	Description
1	Red
2	Black
3	White
4	Green



RoHS

**CONTAINS POLYSULFONE**  
To avoid stress cracking, we suggest using ND Industries' **Vibra-Tite** for thread-locking. **Vibra-Tite** evaporates fast without causing structural failure in OPTEK's molded plastics.  
**Applies to: OPB360, OPB370, OPB380, OPB390 and OPB860, OPB870, OPB880, OPB890.**

OPTEK reserves the right to make changes at any time in order to improve design and to supply the best product possible.

**Slotted Optical Switch**  
**OPB355, OPB360, OPB370, OPB380, OPB390**  
**OPB859, OPB860, OPB870, OPB880, OPB890**  
**Series**



**Part Number Guide — OPB355**

OPB 3 X X X

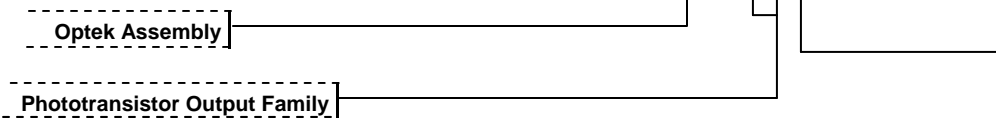

**Mounting Configurations:**  
**N** — No mounting tabs  
**L** — Emitter side mounting tab only  
**P** — Sensor side mounting tab only  
**T** — Two mounting tabs

**Part Number Guide — OPB360 / OPB370**

OPB 3 X X X X X

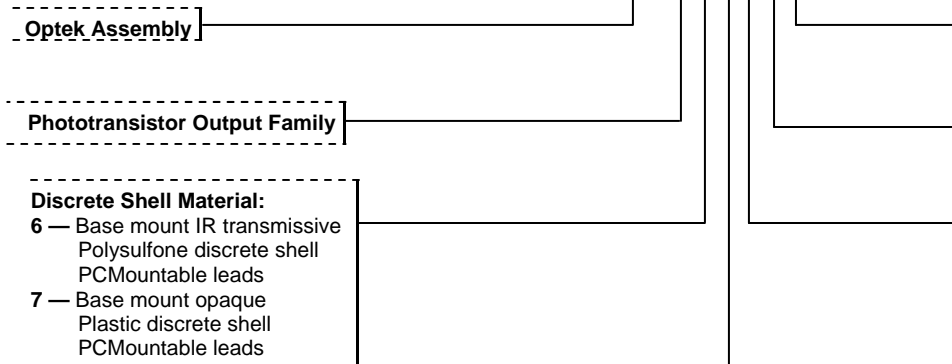

**Sensor Aperture:**  
**1** — 0.010" (0.254 mm)  
**5** — 0.050" (1.270 mm)

**Emitter Sensor:**  
**1** — 0.010" (0.254 mm)  
**5** — 0.050" (1.270 mm)

**Mounting Configurations:**  
**L** — Emitter side mounting tab only  
**N** — No mounting tabs  
**P** — Sensor side mounting tab only  
**T** — Two mounting tabs

**Lead Spacer Designator:**  
**0** = 0.320" (8.12 mm) lead space  
**5** = 0.220" (5.59 mm) lead space

**Part Number Guide — OPB380 / OPB390**

OPB 3 X 0 X X X Z

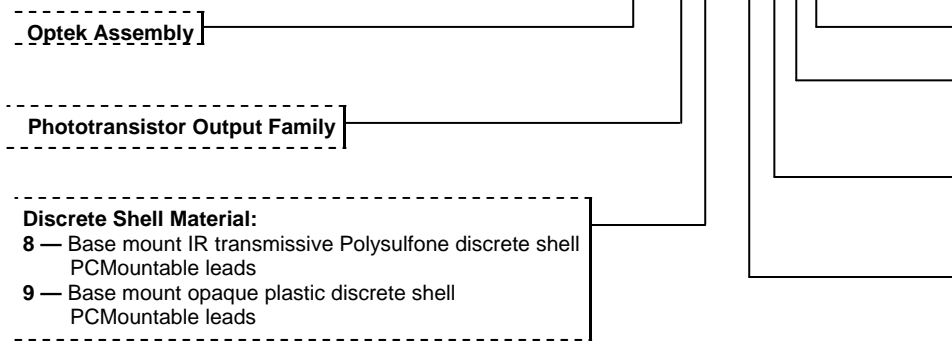

**RoHS Compliant**

**Sensor Aperture:**  
**1** — 0.010" (0.254 mm)  
**5** — 0.050" (1.270 mm)

**Emitter Aperture:**  
**1** — 0.010" (0.254 mm)  
**5** — 0.050" (1.270 mm)

**Mounting Configurations:**  
**L** — Emitter side mounting tab only  
**N** — No mounting tabs  
**P** — Sensor side mounting tab only  
**T** — Two mounting tabs

OPTEK reserves the right to make changes at any time in order to improve design and to supply the best product possible.

# Slotted Optical Switch

OPB355, OPB360, OPB370, OPB380, OPB390  
 OPB859, OPB860, OPB870, OPB880, OPB890  
 Series



## Part Number Guide — OPB859

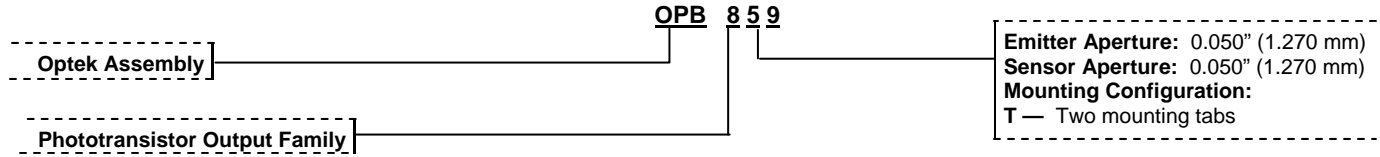

## Part Number Guide — OPB860 / OPB870

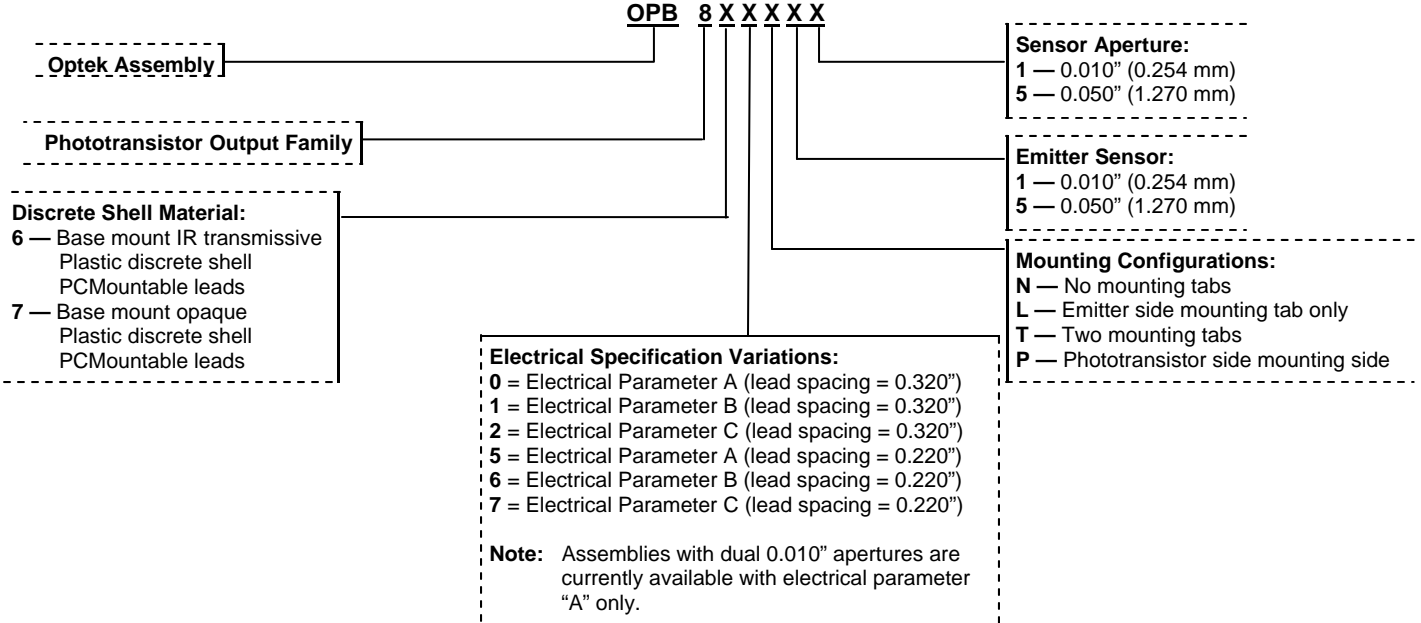

## Part Number Guide — OPB880 / OPB890

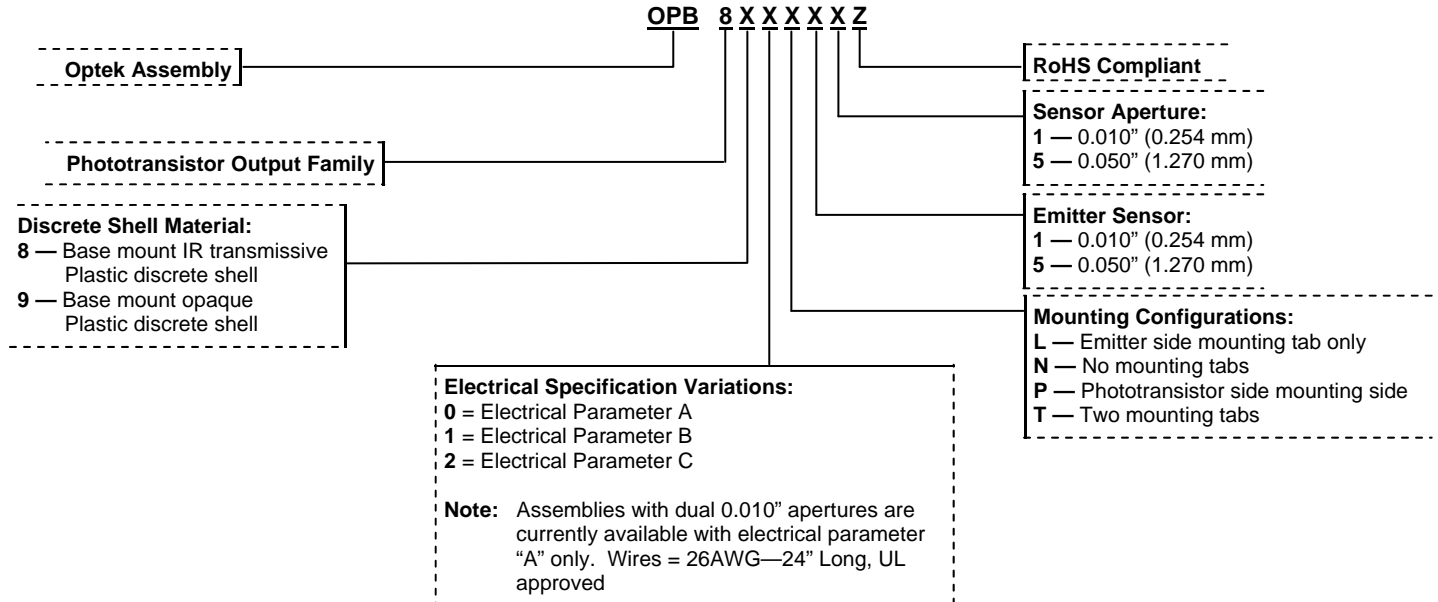

OPTEK reserves the right to make changes at any time in order to improve design and to supply the best product possible.

# Slotted Optical Switch

OPB355, OPB360, OPB370, OPB380, OPB390  
 OPB859, OPB860, OPB870, OPB880, OPB890  
 Series



## OPB355, OPB360, OPB370, OPB860, OPB870



## OPB380, OPB390

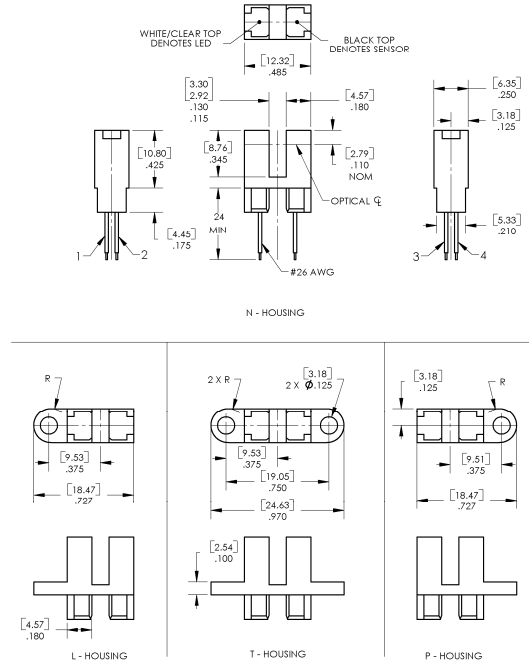

## OPB859



## OPB880, OPB890

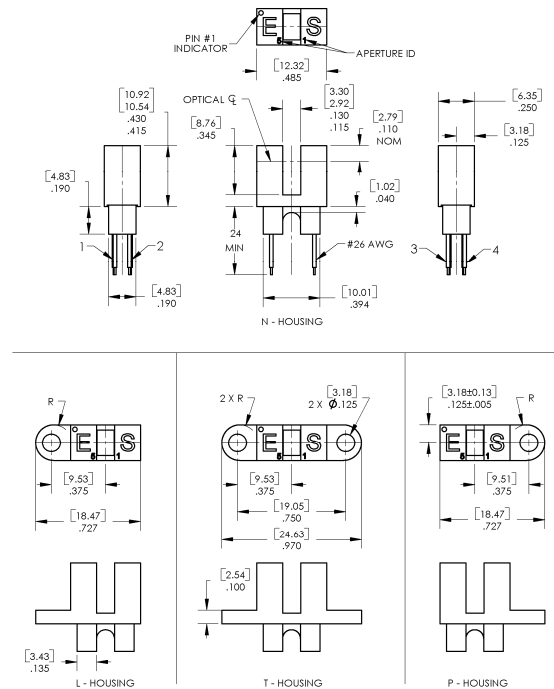

Pin #	Emitter	Pin #	Transistor/Diode
1	Anode	3	Collector / Anode
2	Cathode	4	Emitter / Cathode

DIMENSIONS ARE IN: [ MILLIMETERS ]  
 INCHES

OPTEK reserves the right to make changes at any time in order to improve design and to supply the best product possible.

**Slotted Optical Switch**  
**OPB355, OPB360, OPB370, OPB380, OPB390**  
**OPB859, OPB860, OPB870, OPB880, OPB890**  
**Series**



**Absolute Maximum Ratings** ( $T_A=25^{\circ}\text{C}$  unless otherwise noted)

Storage Temperature <sup>(1) (2)</sup> OPB355, OPB360, OPB370, OPB859, OPB860, OPB870 Series OPB380, OPB390, OPB880, OPB890 Series	-40° C to +100° C -40° C to +85° C
Operating Temperature <sup>(1) (2)</sup>	-40° C to +85° C
Lead Soldering Temperature <sup>(7)</sup>	260° C

**Input LED**

Forward DC Current OPB355, OPB360, OPB370, OPB380, OPB390, OPB859, OPB860, OPB870, OPB880, OPB890	50 mA
Peak Forward Current (1 $\mu\text{s}$ pulse width, 300 pps)	1 A
Reverse DC Voltage	2 V
Power Dissipation <sup>(2)</sup>	75 mW

**Output Phototransistor/Diode**

Cathode-Anode Reverse Voltage -OPB355	60 V
Collector-Emitter Voltage OPB360, OPB370, OPB380, OPB390, OPB859, OPB860, OPB870, OPB880, OPB890 Series	30 V
Emitter-Collector Voltage	5 V
Collector DC Current	30 mA
Power Dissipation <sup>(1)</sup>	100 mW

Notes:

- (1) For wire series (OPB380, OPB390, OPB880 and OPB890), maximum storage and operating temperature is limited by the temperature rating of the lead wires.
- (2) Derate linearly 1.67 mW/° C above 25° C.
- (3) For OPB355, OPB360 and OPB370, polarity is denoted by color of housing top: LED (clear); sensor (black).
- (4) Cleaning agents methanol and isopropanol are recommended. Spray or wipe; do not submerge.
- (5) OPB380 and OPB390 wire terminations have 24" of 7-strand 26 AWG UL approved insulated wire on each terminal. These devices incorporate a wire strain relief at the housing surface. The insulation colors and functions are: IRED anode (red); IRED cathode (black); phototransistor collector (white); phototransistor emitter (green).
- (6) RMA flux is recommended. Duration can be extended to 10 seconds maximum when flow soldering.
- (7) All parameters were tested using pulse technique.

OPTEK reserves the right to make changes at any time in order to improve design and to supply the best product possible.

**Slotted Optical Switch**  
**OPB355, OPB360, OPB370, OPB380, OPB390**  
**OPB859, OPB860, OPB870, OPB880, OPB890**  
**Series**



**Electrical Characteristics** ( $T_A = 25^\circ\text{C}$  unless otherwise noted)

SYMBOL	PARAMETER	MIN	TYP	MAX	UNITS	TEST CONDITIONS
--------	-----------	-----	-----	-----	-------	-----------------

**Input Transistor/Diode** (See OP240 for additional information—for reference only)

$V_F$	Forward Voltage	-	1.3	1.8	V	$I_F = 20\text{ mA}$
$I_R$	Reverse Current	-	-	100	$\mu\text{A}$	$V_R = 2\text{ V}$

**Output Diode — OPB355** (See OPB950 for additional information — for reference only)

$V_{BR}$	Reverse Diode Breakdown Voltage	60	-	-	V	$I_R = 100\ \mu\text{A}$ , $I_F = 0$ , $E_E = 0$
$V_{FD}$	Forward Voltage Photodiode	-	-	1.2	V	$I_F = 1\text{ mA}$ , $I_F = 0$ , $E_E = 0$
ID	Reverse Dark Current	-	-	60	nA	$V_R = 30\text{ V}$ , $E_E = 0$ , $I_F = 0$

**Output Transistor** (See OP550 for additional information—for reference only)

$V_{(BR)CEO}$	Collector-Emitter Breakdown Voltage	30	-	-	V	$I_C = 1\text{ mA}$
$V_{(BR)ECO}$	Emitter-Collector Breakdown Voltage	5	-	-	V	$I_E = 100\ \mu\text{A}$
$I_{CEO}$	Collector-Emitter Dark Current	-	-	100	nA	$V_{CE} = 10\text{ V}$ , $I_F = 0$ , $E_E = 0$

**Coupled**

$I_L$	On-State Collector Current OPB355 (L, N, P, T)	10	-	200	$\mu\text{A}$	$V_R = 5\text{ V}$ , $I_F = 40\text{ mA}$
$V_{CE(SAT)}$	Collector-Emitter Saturation Voltage OPB859 OPB860/870/865/875 (Para. A) OPB861/871/866/876 (Para. B) OPB862/872/867/877 (Para. C) OPB880/890/ (Para. A) OPB881/891 (Para. B) OPB882/892 (Para. C)	- - - - - - -	- - - - - - -	0.4 0.4 0.4 0.6 0.4 0.4 0.6	V	$I_C = 125\ \mu\text{A}$ , $I_F = 20\text{ mA}$ $I_C = 400\ \mu\text{A}$ , $I_F = 20\text{ mA}$ $I_C = 800\ \mu\text{A}$ , $I_F = 20\text{ mA}$ $I_C = 1800\ \mu\text{A}$ , $I_F = 20\text{ mA}$ $I_C = 400\ \mu\text{A}$ , $I_F = 20\text{ mA}$ $I_C = 800\ \mu\text{A}$ , $I_F = 10\text{ mA}$ $I_C = 1800\ \mu\text{A}$ , $I_F = 20\text{ mA}$
$I_{C(ON)}$	On-State Collector Current OPB36X, OPB37X (T, N, L, P 11) OPB36X, OPB37X (T, N, L, P 51) OPB36X, OPB37X (T, N, L, P 55) OPB38X, OPB39X (T, N, L, P 11) OPB38X, OPB39X (T, N, L, P 51) OPB38X, OPB39X (T, N, L, P 55) OPB859 OPB860/870/865/875 (Para. A) OPB861/871/866/876 (Para. B) OPB862/872/867/877 (Para. C) OPB880/890/ (Para. A) OPB881/891 (Para. B) OPB882/892 (Para. C)	1.0 2.5 3.5 1.0 2.5 3.5	- - - - - -	5 10 14 5 10 14	mA	$V_{CE} = 0.4\text{ V}$ , $I_F = 20\text{ mA}$
		250	-	-	$\mu\text{A}$	$V_{CE} = 10\text{ V}$ , $I_F = 20\text{ mA}$
		0.5 1.0 1.8 0.5 1.0 1.8	- - - - - -	- - - - - -	mA	$V_{CE} = 10\text{ V}$ , $I_F = 20\text{ mA}$ $V_{CE} = 5\text{ V}$ , $I_F = 10\text{ mA}$ $V_{CE} = 0.6\text{ V}$ , $I_F = 20\text{ mA}$ $V_{CE} = 10\text{ V}$ , $I_F = 20\text{ mA}$ $V_{CE} = 5\text{ V}$ , $I_F = 10\text{ mA}$ $V_{CE} = 0.6\text{ V}$ , $I_F = 20\text{ mA}$

OPTEK reserves the right to make changes at any time in order to improve design and to supply the best product possible.

**Slotted Optical Switch**  
**OPB355, OPB360, OPB370, OPB380, OPB390**  
**OPB859, OPB860, OPB870, OPB880, OPB890**  
**Series**

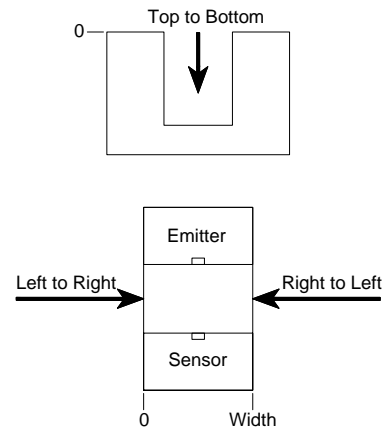
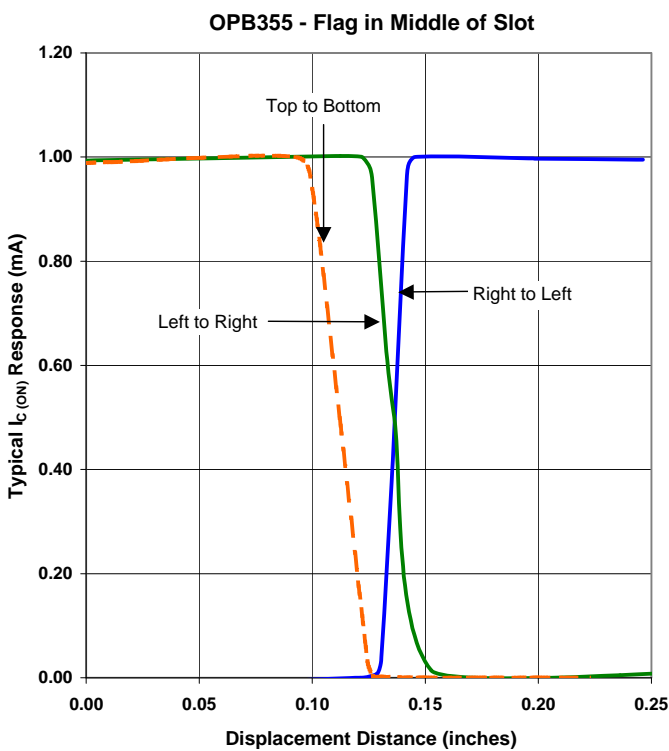
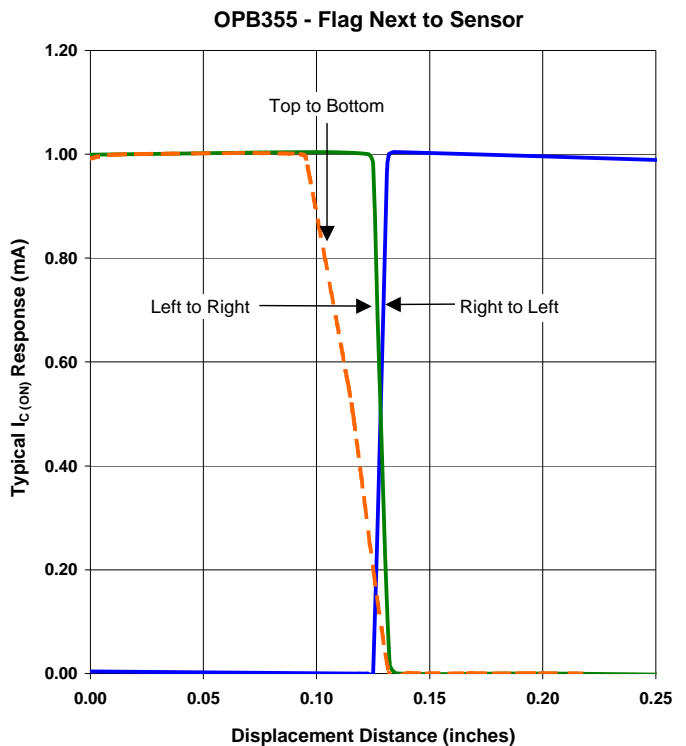
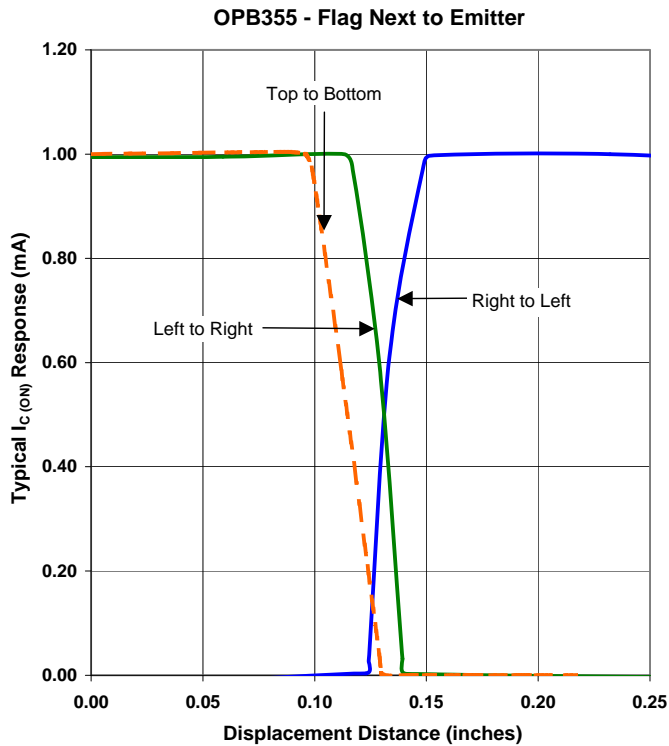

OPTEK reserves the right to make changes at any time in order to improve design and to supply the best product possible.

**Slotted Optical Switch**  
**OPB355, OPB360, OPB370, OPB380, OPB390**  
**OPB859, OPB860, OPB870, OPB880, OPB890**  
**Series**



Aperture Configuration 11 - Flag Next to Emitter

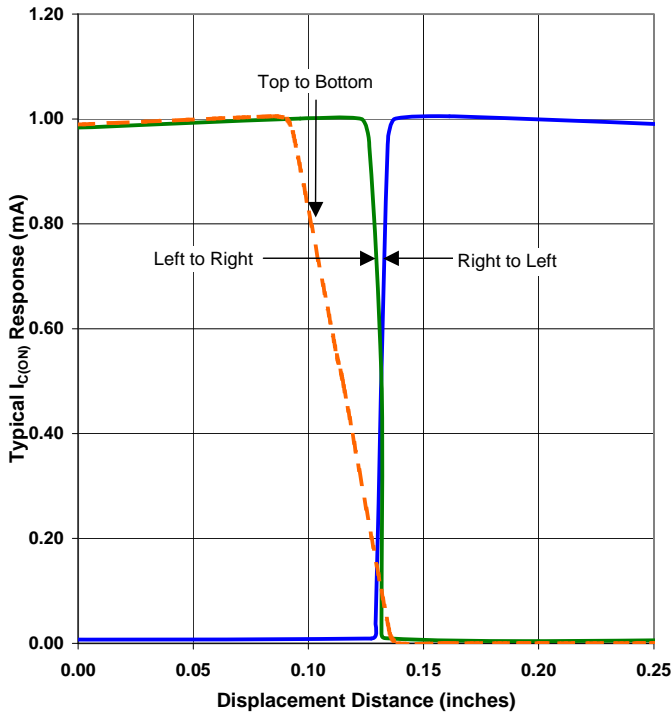

Aperture Configuration 11 - Flag Next to Sensor

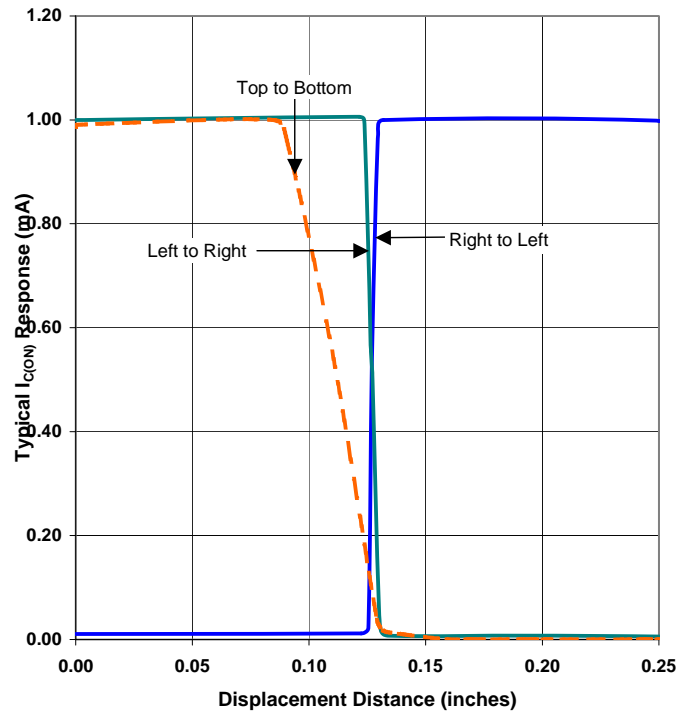

Aperture Configuration 11 - Flag in Middle of Slot

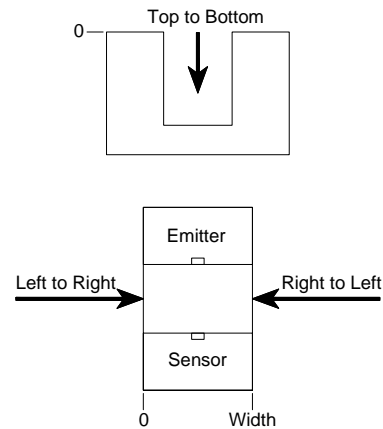
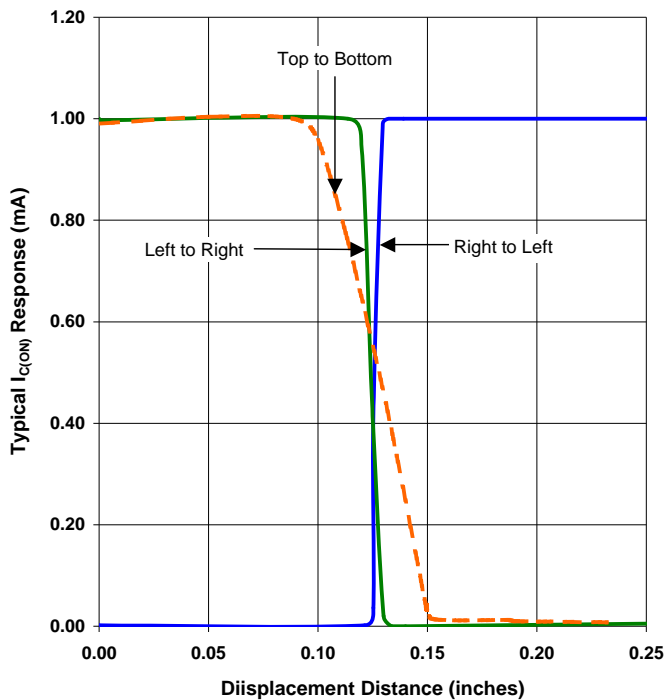

OPTEK reserves the right to make changes at any time in order to improve design and to supply the best product possible.



# Slotted Optical Switch

OPB355, OPB360, OPB370, OPB380, OPB390  
 OPB859, OPB860, OPB870, OPB880, OPB890  
 Series



Aperture Configuration 51 - Flag Next to Emitter

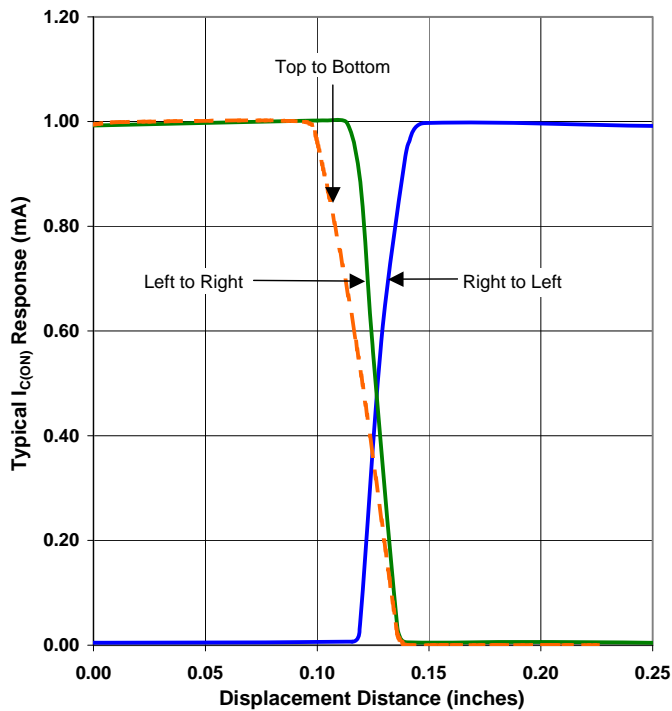

Aperture Configuration 51 - Flag Next to Sensor

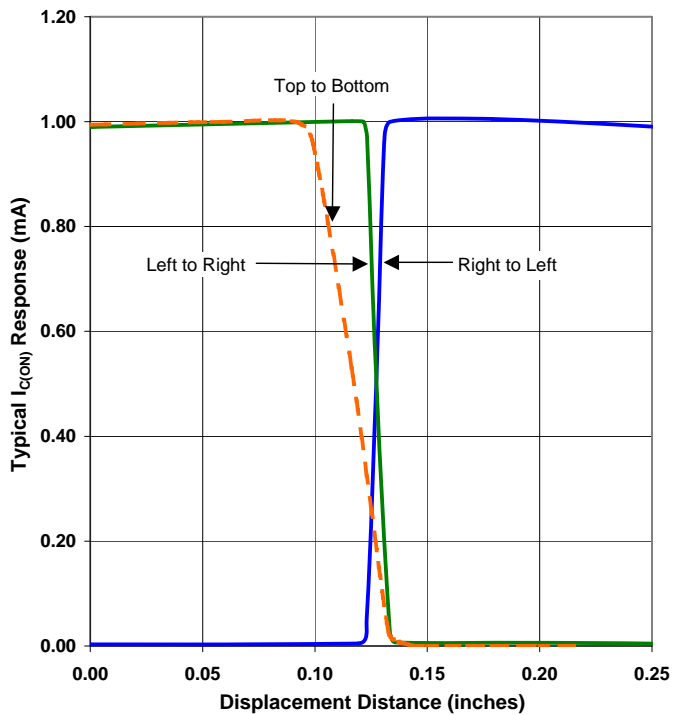

Aperture Configuration 51 - Flag in Middle of Slot

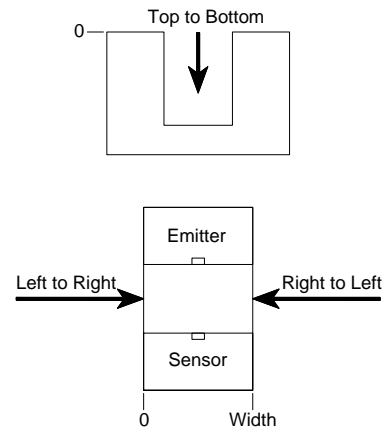
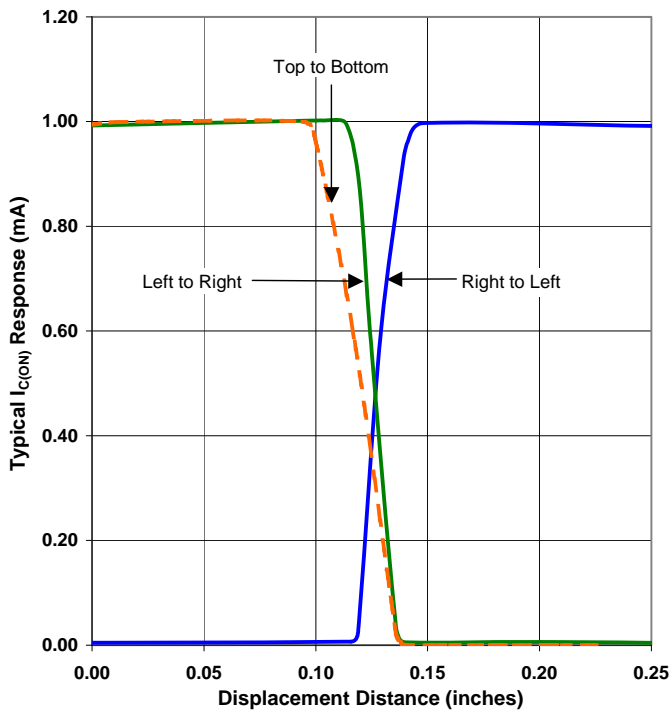

OPTEK reserves the right to make changes at any time in order to improve design and to supply the best product possible.

# Slotted Optical Switch

OPB355, OPB360, OPB370, OPB380, OPB390  
 OPB859, OPB860, OPB870, OPB880, OPB890  
 Series



Aperture Configuration 55 - Flag Next to Emitter

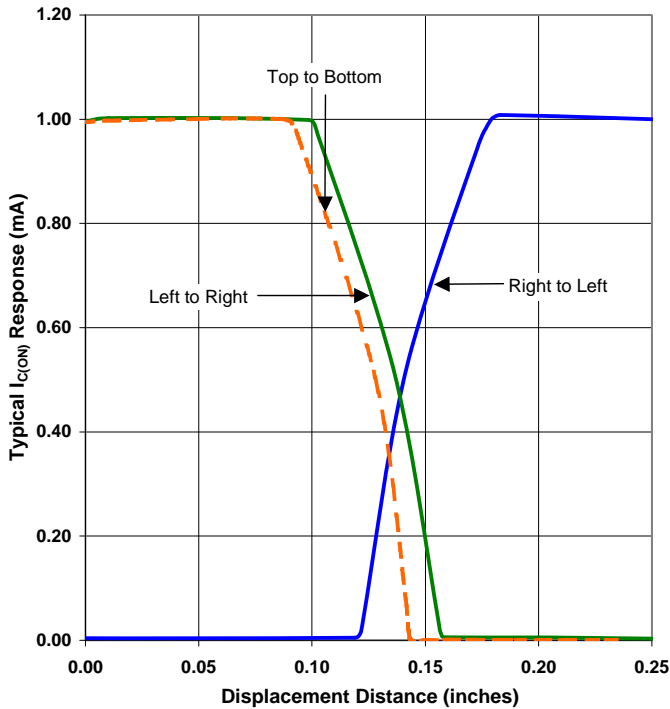

Aperture Configuration 55 - Flag Next to Sensor

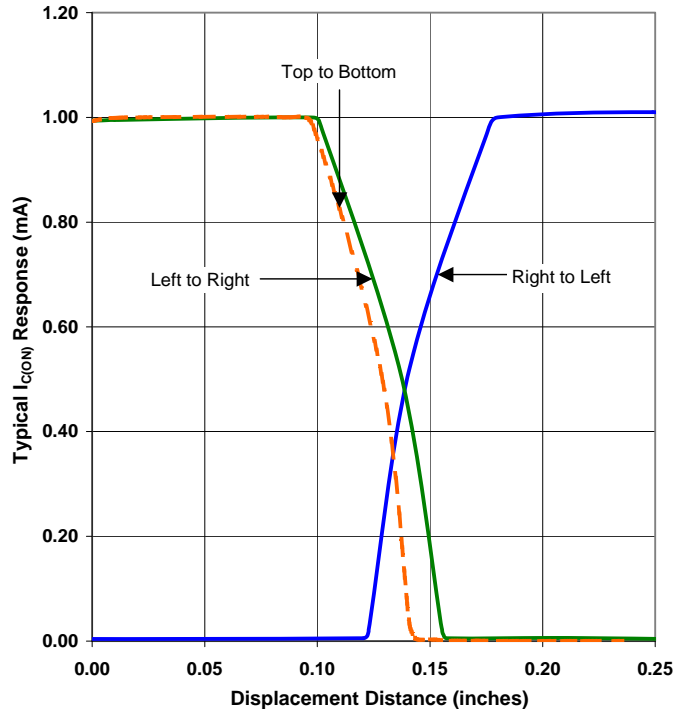

Aperture Configuration 55 - Flag in Middle of Slot

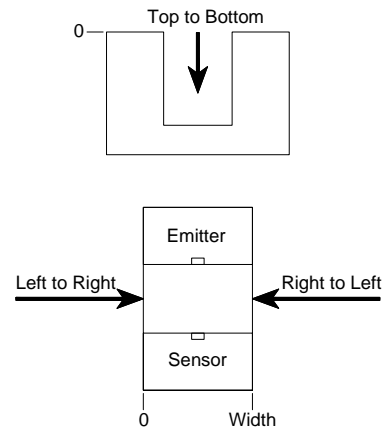
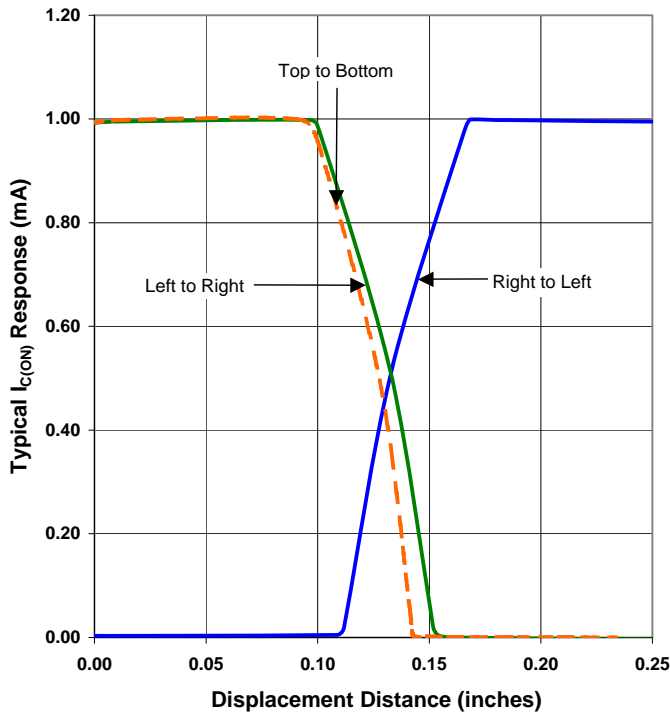

OPTEK reserves the right to make changes at any time in order to improve design and to supply the best product possible.