

**YELLOW MAN5350/5360
GREEN MAN5450/5460**

**RED MAN5750/5760
HER MAN5950/5960**

PACKAGE DIMENSIONS

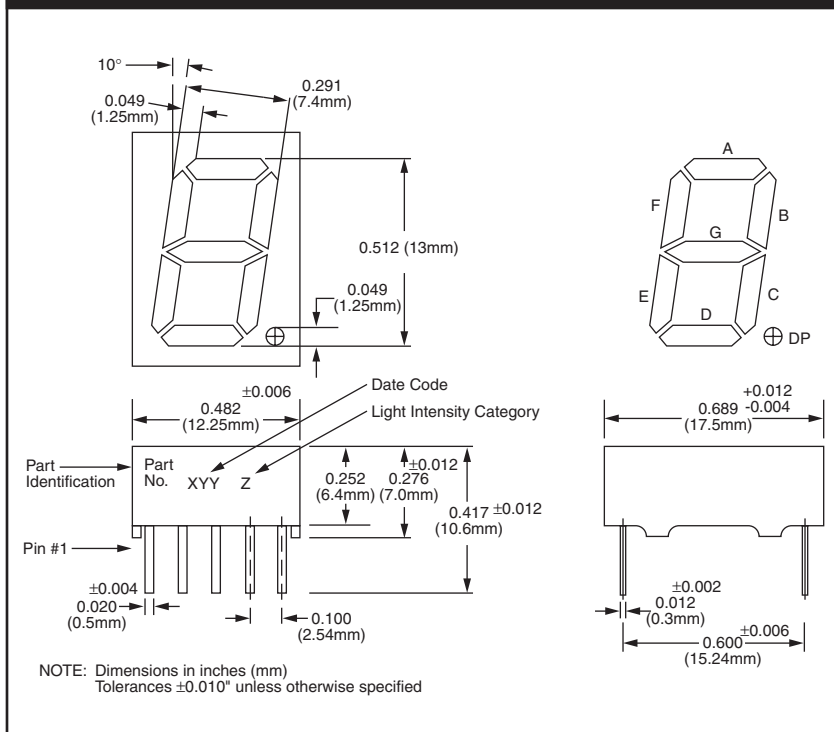

DESCRIPTION

This display series is a family of large digits 0.510 inches in height. All models have right hand decimal points and are available in common anode or common cathode configurations. All units are constructed with untinted segments on grey face to enhance ON/OFF contrast. Standard units are available in red, orange-red, green and yellow.

FEATURES

- Large, easy to read, digits
- Common anode or common cathode models
- Fast switching — excellent for multiplexing
- Low power consumption
- Bold solid segments that are highly legible
- Solid state reliability — long operation life
- Rugged plastic construction
- Directly compatible with integrated circuits
- High brightness with high contrast
- Categorized for Luminous Intensity (See Note 5)
- Wide angle viewing...150°
- Low forward voltage
- Untinted segments on grey face

APPLICATIONS

For industrial and consumer applications such as:

- Digital readout displays
- Instrument panels
- Point of sale equipment
- Digital clocks
- TV and radios

MODEL NUMBERS			
Part Number	Color	Description	Pin Out Specification (See Page 5)
MAN5350	Yellow	Common Anode	A
MAN5360	Yellow	Common Cathode	B
MAN5450	Green	Common Anode	A
MAN5460	Green	Common Cathode	B
MAN5750	Red	Common Anode	A
MAN5760	Red	Common Cathode	B
MAN5950	HER	Common Anode	A
MAN5960	HER	Common Cathode	B

**YELLOW MAN5350/5360
GREEN MAN5450/5460**

**RED MAN5750/5760
HER MAN5950/5960**

ELECTRO-OPTICAL CHARACTERISTICS ($T_A = 25^\circ\text{C}$ Unless Otherwise Specified)

Parameter	Min.	Typ.	Max.	Units	Test Condition
Yellow MAN5350/MAN5360					
Luminous Intensity, digit average (See Note 1)	820	1200 480		μcd μcd	$I_F = 10\text{ mA}$ $I_F = 5\text{ mA}$
Peak emission wavelength		585		nm	$I_F = 10\text{ mA}$
Dominant wavelength	582		593	nm	$I_F = 10\text{ mA}$
Spectral line half width		40		nm	
Forward voltage		2.4	3.0	V	$I_F = 20\text{ mA}$
Dynamic resistance		26			$I_F = 20\text{ mA}$
Capacitance		35		pF	$V_R = 0, f = 1\text{ MHz}$
Reverse current			10	μA	$V_R = 6.0\text{ V}$
Green MAN5450/MAN5460					
Luminous Intensity, digit average (See Note 1)	820	3000 1000		μcd μcd	$I_F = 10\text{ mA}$ $I_F = 5\text{ mA}$
Peak emission wavelength		562		nm	$I_F = 10\text{ mA}$
Dominant wavelength	564		574	nm	$I_F = 10\text{ mA}$
Spectral line half width		30		nm	
Forward voltage		2.4	3.0	V	$I_F = 20\text{ mA}$
Dynamic resistance		12			$I_F = 20\text{ mA}$
Capacitance		40		pF	$V_R = 0, f = 1\text{ MHz}$
Reverse current			10	μA	$V_R = 6.0\text{ V}$

YELLOW MAN5350/5360
GREEN MAN5450/5460

RED MAN5750/5760
HER MAN5950/5960

ELECTRO-OPTICAL CHARACTERISTICS ($T_A = 25^\circ\text{C}$ Unless Otherwise Specified)

Parameter	Min.	Typ.	Max.	Units	Test Condition
Red MAN5750/MAN5760					
Luminous Intensity, digit average (See Note 1)	280	500 250		μcd μcd	$I_F = 10\text{ mA}$ $I_F = 5\text{ mA}$
Peak emission wavelength		655		nm	$I_F = 10\text{ mA}$
Dominant wavelength		645		nm	$I_F = 10\text{ mA}$
Spectral line half width		20		nm	
Forward voltage		1.6	2.0	V	$I_F = 20\text{ mA}$
Dynamic resistance		2			$I_F = 20\text{ mA}$
Capacitance		35		pF	$V_R = 0, f = 1\text{ MHz}$
Reverse current			10	μA	$V_R = 6.0\text{ V}$
HER MAN5950/MAN5960					
Luminous Intensity, digit average (See Note 1)	820	2500 700		μcd μcd	$I_F = 10\text{ mA}$ $I_F = 5\text{ mA}$
Peak emission wavelength		635		nm	$I_F = 10\text{ mA}$
Dominant wavelength	615		630	nm	$I_F = 10\text{ mA}$
Spectral line half width		40		nm	
Forward voltage		2.0	3.0	V	$I_F = 20\text{ mA}$
Dynamic resistance		26			$I_F = 20\text{ mA}$
Capacitance		35		pF	$V_R = 0, f = 1\text{ MHz}$
Reverse current			10	μA	$V_R = 6.0\text{ V}$

**YELLOW MAN5350/5360
GREEN MAN5450/5460**

**RED MAN5750/5760
HER MAN5950/5960**

ABSOLUTE MAXIMUM RATINGS				
Rating	MAN5350 MAN5360	MAN5450 MAN5460	MAN5750 MAN5760	MAN5950 MAN5960
Power dissipation at 25°C ambient	600 mW	570 mW	480 mW	600 mW
Derate linearly from 50°C	-10.3 mW/°C	-12 mW/°C	-6.9 mW/°C	-8.6 mW/°C
Storage and operating temperature	-40°C to +85°C	-40°C to +85°C	-40°C to +85°C	-40°C to +85°C
Continuous forward current				
Total	200 mA	240 mA	240 mA	240 mA
Per segment	25 mA	30 mA	30 mA	30 mA
Decimal point	25 mA	30 mA	30 mA	30 mA
Reverse voltage				
Per segment	6.0 V	6.0 V	6.0 V	6.0 V
Decimal point	6.0 V	6.0 V	6.0 V	6.0 V
Soldering time at 260°C (See Notes 3 and 4)	5 sec.	5 sec.	5 sec.	5 sec.

Notes:

1. The digit average Luminous Intensity is obtained by summing the Luminous Intensity of each segment and dividing by the total number of segments. Intensity will not vary more than $\pm 33.3\%$ between all segments within a digit.
2. The relative Luminous Intensity in this curve is normalized to the brightness at 25°C to indicate the relative efficiency over the operating temperature range.
3. Leads of the device immersed to 1/16 inch from the body. Maximum device surface temperature is 140°C.
4. For flux removal, Freon TF, Freon TE, Isoproponal or water may be used to up their boiling points.
5. All displays are categorized for Luminous Intensity. The intensity category is marked on each part as a suffix letter to the part number.

RECOMMENDED OPTICAL FILTERS			
For optimum ON and OFF contrast, one of the following filters or equivalents should be used over the display:			
Device Type	Filter	Device Type	Filter
MAN5350 MAN5360	Panelgraphic Yellow 25 or Amber 23 Homalite 100-1720 or 100-1726 Panelgraphic Grey 10 Homalite 100-1266 Grey	MAN5450 MAN5460	Panelgraphic Green 48 Homalite 100-1440 Green Panelgraphic Grey 10 Homalite 100-1266 Grey
MAN5750 MAN5760	Panelgraphic Red 60 Homalite 100-1605	MAN5950 MAN5960	Panelgraphic Scarlet 65 Homalite 100-1670

YELLOW MAN5350/5360
GREEN MAN5450/5460

RED MAN5750/5760
HER MAN5950/5960

ELECTRICAL CONNECTIONS

Pin No.	A MAN5X50	B MAN5X60
1	Cathode E	Anode E
2	Cathode D	Anode D
3	Com. Anode	Com. Cathode
4	Cathode C	Anode C
5	Cathode D.P.	Anode D.P.
6	Cathode B	Anode B
7	Cathode A	Anode A
8	Com. Anode	Com. Cathode
9	Cathode F	Anode F
10	Cathode G	Anode G

INTERNAL CONNECTIONS

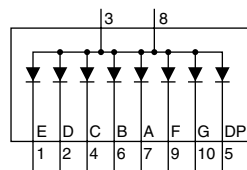

MAN5X50

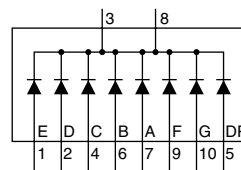

MAN5X60

**YELLOW MAN5350/5360
GREEN MAN5450/5460**

**RED MAN5750/5760
HER MAN5950/5960**

TYPICAL CHARACTERISTIC CURVES — MAN5350/MAN5360

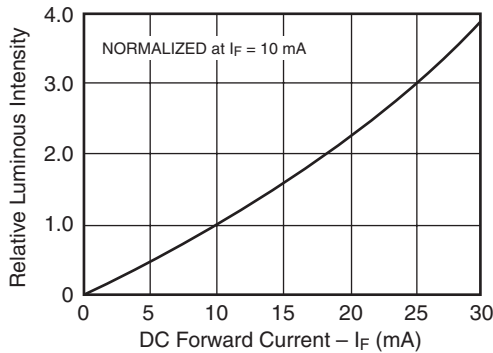

Fig. 1A. Relative Luminous Intensity vs. DC Forward Current

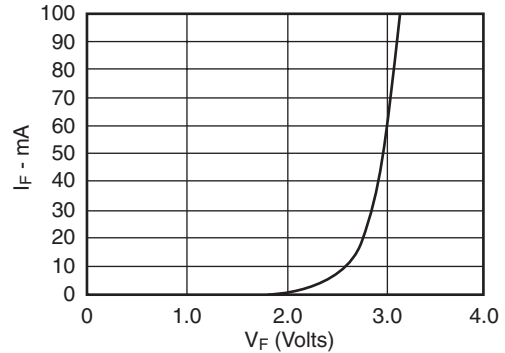

Fig. 1B. Forward Current vs. Forward Voltage

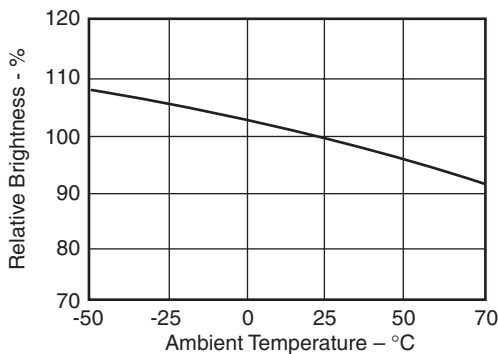

Fig. 1C. Relative Luminous Intensity vs. Temperature (See Note 2)

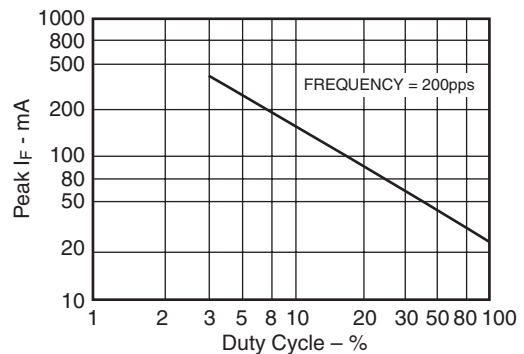

Fig. 1D. Max Peak Current vs. Duty Cycle

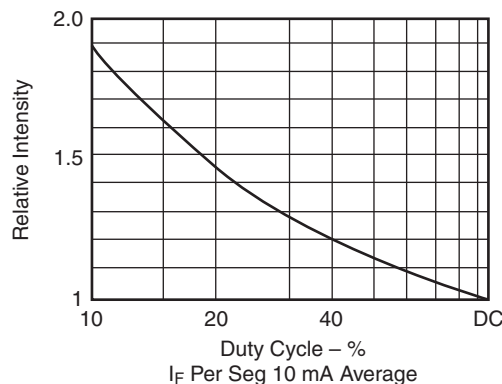

Fig. 1E. Relative Luminous Intensity vs. Duty Cycle

**YELLOW MAN5350/5360
GREEN MAN5450/5460**

**RED MAN5750/5760
HER MAN5950/5960**

TYPICAL CHARACTERISTIC CURVES — MAN5450/MAN5460

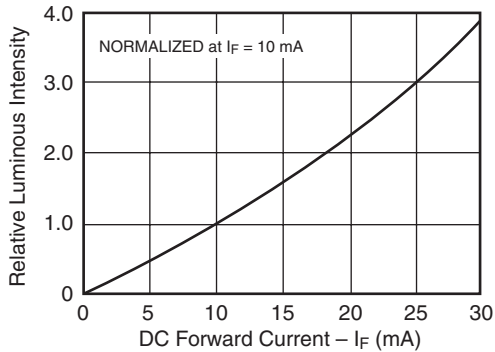

Fig. 2A. Relative Luminous Intensity vs. DC Forward Current

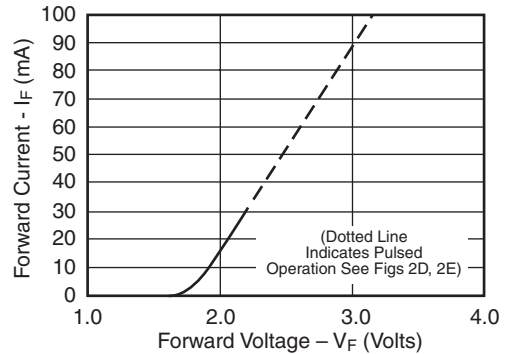

Fig. 2B. Forward Current vs. Forward Voltage

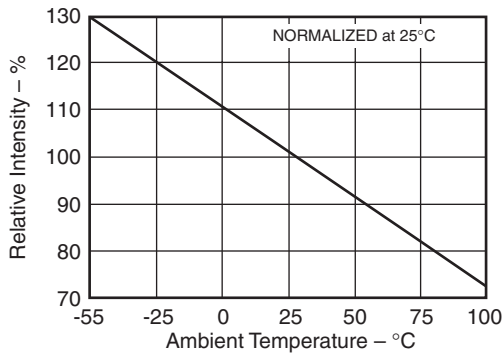

Fig. 2C. Relative Luminous Intensity vs. Temperature (See Note 2)

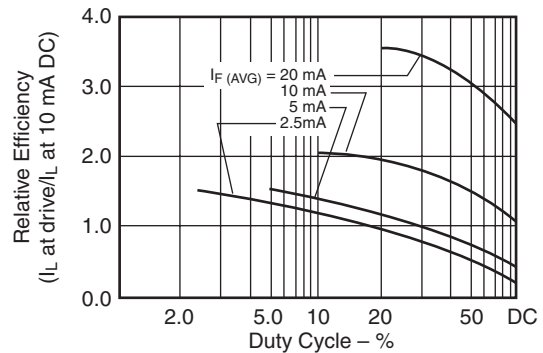

Fig. 2D. Relative Efficiency vs. Duty Cycle

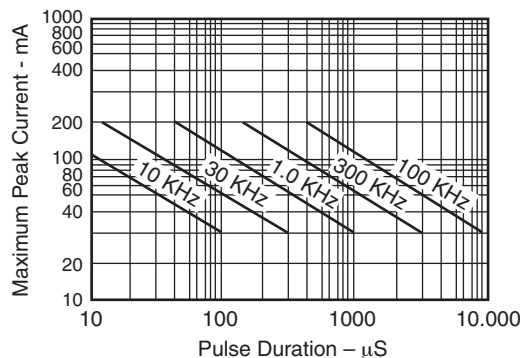

Fig. 2E. Maximum Peak Current vs. Pulse Duration

YELLOW MAN5350/5360
GREEN MAN5450/5460

RED MAN5750/5760
HER MAN5950/5960

TYPICAL CHARACTERISTIC CURVES — MAN5750/MAN5760

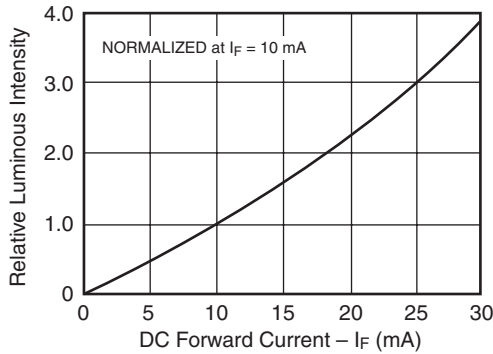

Fig. 3A. Relative Luminous Intensity vs. DC Forward Current

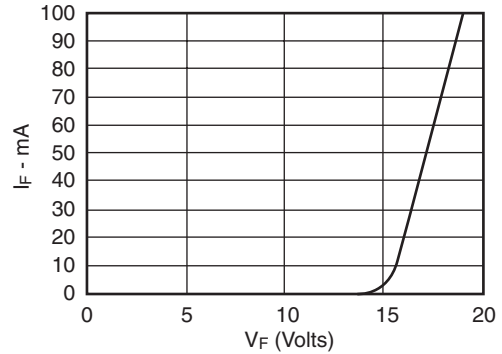

Fig. 3B. Forward Current vs. Forward Voltage

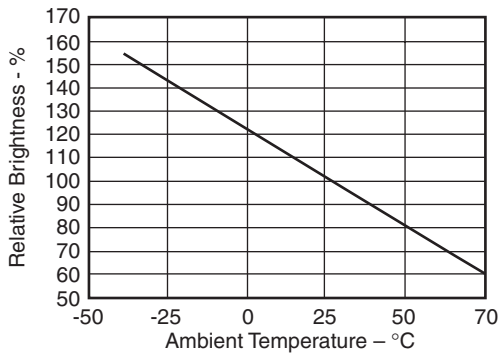

Fig. 3C. Relative Luminous Intensity vs. Temperature
(See Note 2)

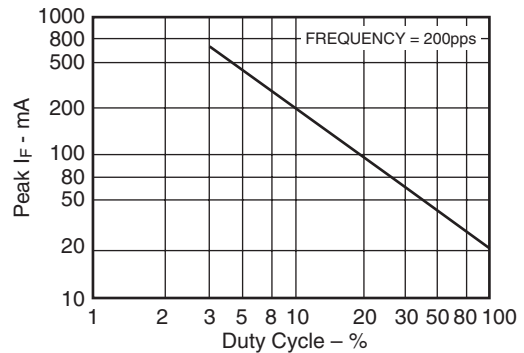

Fig. 3D. Max Peak Current vs. Duty Cycle

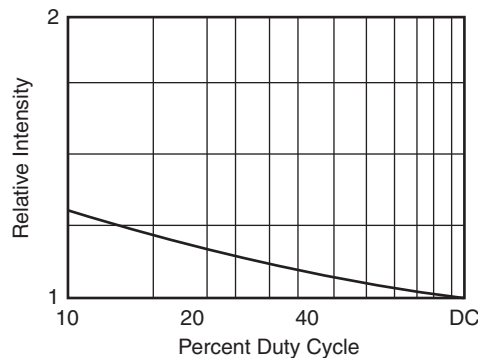

Fig. 3E. Relative Luminous Intensity vs. Duty Cycle

YELLOW MAN5350/5360
GREEN MAN5450/5460

RED MAN5750/5760
HER MAN5950/5960

TYPICAL CHARACTERISTIC CURVES — MAN5950/MAN5960

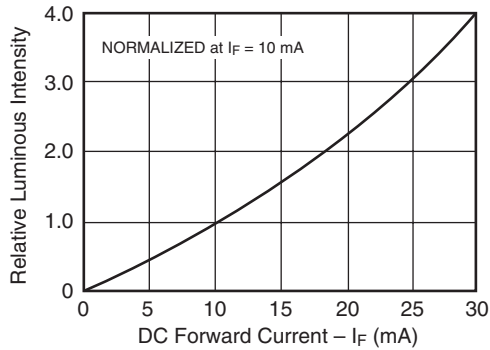

Fig. 4A. Relative Luminous Intensity vs. Forward Current

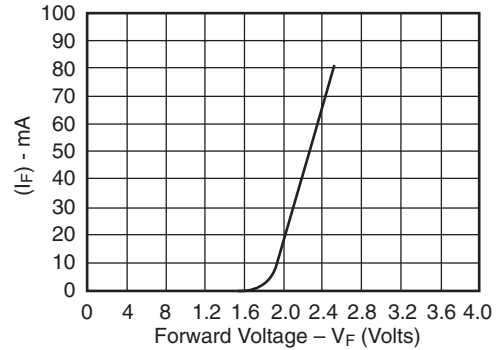

Fig. 4B. Forward Current vs. Forward Voltage

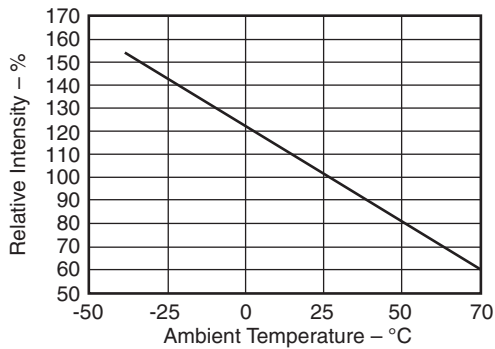

Fig. 3C. Relative Luminous Intensity vs. Temperature
(See Note 2)

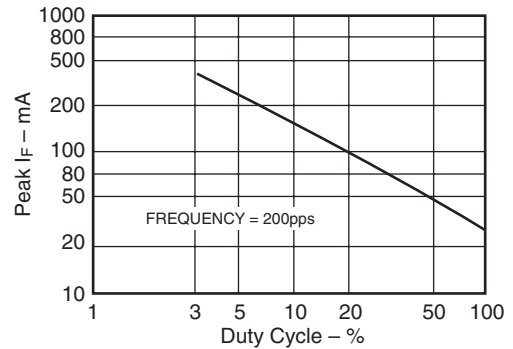

Fig. 4D. Maximum Peak Current vs. Duty Cycle

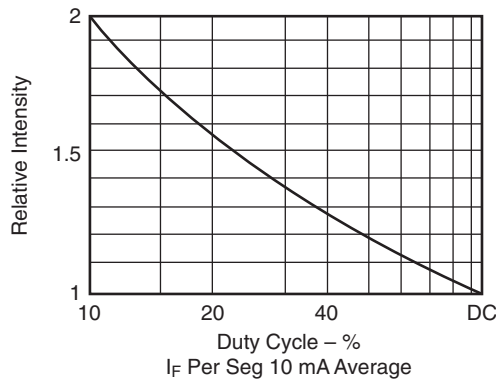

Fig. 4E. Relative Luminous Intensity vs. Duty Cycle

YELLOW MAN5350/5360
GREEN MAN5450/5460

RED MAN5750/5760
HER MAN5950/5960

DISCLAIMER

FAIRCHILD SEMICONDUCTOR RESERVES THE RIGHT TO MAKE CHANGES WITHOUT FURTHER NOTICE TO ANY PRODUCTS HEREIN TO IMPROVE RELIABILITY, FUNCTION OR DESIGN. FAIRCHILD DOES NOT ASSUME ANY LIABILITY ARISING OUT OF THE APPLICATION OR USE OF ANY PRODUCT OR CIRCUIT DESCRIBED HEREIN; NEITHER DOES IT CONVEY ANY LICENSE UNDER ITS PATENT RIGHTS, NOR THE RIGHTS OF OTHERS.

LIFE SUPPORT POLICY

FAIRCHILD'S PRODUCTS ARE NOT AUTHORIZED FOR USE AS CRITICAL COMPONENTS IN LIFE SUPPORT DEVICES OR SYSTEMS WITHOUT THE EXPRESS WRITTEN APPROVAL OF THE PRESIDENT OF FAIRCHILD SEMICONDUCTOR CORPORATION. As used herein:

1. Life support devices or systems are devices or systems which, (a) are intended for surgical implant into the body, or (b) support or sustain life, and (c) whose failure to perform when properly used in accordance with instructions for use provided in the labeling, can be reasonably expected to result in a significant injury of the user.
2. A critical component in any component of a life support device or system whose failure to perform can be reasonably expected to cause the failure of the life support device or system, or to affect its safety or effectiveness.