

DS90LV017A

LVDS Single High Speed Differential Driver

General Description

The DS90LV017A is a single LVDS driver device optimized for high data rate and low power applications. The DS90LV017A is a current mode driver allowing power dissipation to remain low even at high frequency. In addition, the short circuit fault current is also minimized. The device is designed to support data rates in excess of 600Mbps (300MHz) utilizing Low Voltage Differential Signaling (LVDS) technology.

The device is in a 8-lead small outline package. The DS90LV017A has a flow-through design for easy PCB layout. The differential driver outputs provides low EMI with its typical low output swing of 355 mV. The DS90LV017A can be paired with its companion single line receiver, the DS90LV018A, or with any of National's LVDS receivers, to provide a high-speed point-to-point LVDS interface.

Features

- >600 Mbps (300 MHz) switching rates
- 0.3 ns typical differential skew
- 0.7 ns maximum differential skew
- 1.5 ns maximum propagation delay
- 3.3V power supply design
- ±355 mV differential signaling
- Low power dissipation (23 mW @ 3.3V static)
- Flow-through design simplifies PCB layout
- Interoperable with existing 5V LVDS devices
- Power Off Protection (outputs in high impedance)
- Conforms to TIA/EIA-644 Standard
- 8-Lead SOIC package saves space
- Industrial temperature operating range (-40°C to +85°C)

Connection Diagram

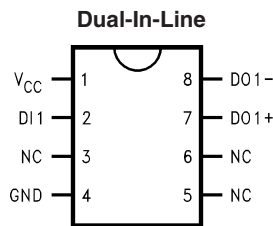

10010101

Order Number DS90LV017ATM
See NS Package Number M08A

Functional Diagram

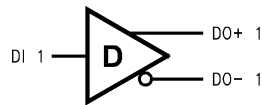

10010102

TRI-STATE® is a registered trademark of National Semiconductor Corporation.

Absolute Maximum Ratings (Note 1)

If Military/Aerospace specified devices are required, please contact the National Semiconductor Sales Office/Distributors for availability and specifications.

Supply Voltage (V_{CC})	-0.3V to +4V
Input Voltage (DI)	-0.3V to +3.6V
Output Voltage (DO \pm)	-0.3V to +3.9V
Maximum Package Power Dissipation @ +25°C	
M Package	1190 mW
Derate M Package	9.5 mW/°C above +25°C
Storage Temperature Range	-65°C to +150°C
Lead Temperature Range Soldering (4 sec.)	+260°C

ESD Ratings

(HBM 1.5 k Ω , 100 pF)	≥ 8 kV
(EIAJ 0 Ω , 200 pF)	≥ 1000 V
(CDM)	≥ 1000 V
(IEC direct 330 Ω , 150 pF)	≥ 4 kV

Recommended Operating Conditions

	Min	Typ	Max	Units
Supply Voltage (V_{CC})	3.0	3.3	3.6	V
Temperature (T_A)	-40	25	+85	°C

Electrical Characteristics

Over Supply Voltage and Operating Temperature ranges, unless otherwise specified. (Notes 2, 3, 7)

Symbol	Parameter	Conditions	Pin	Min	Typ	Max	Units	
DIFFERENTIAL DRIVER CHARACTERISTICS								
V_{OD}	Output Differential Voltage	$R_L = 100\Omega$ (Figure 1)	DO+, DO-	250	355	450	mV	
ΔV_{OD}	V_{OD} Magnitude Change				1	35	mV	
V_{OH}	Output High Voltage				1.4	1.6	V	
V_{OL}	Output Low Voltage				0.9	1.1	V	
V_{OS}	Offset Voltage				1.125	1.2	1.375	V
ΔV_{OS}	Offset Magnitude Change				0	3	25	mV
I_{OXD}	Power-off Leakage	$V_{OUT} = V_{CC}$ or GND, $V_{CC} = 0V$			± 1	± 10	μA	
I_{OSD}	Output Short Circuit Current				-5.7	-8	mA	
V_{IH}	Input High Voltage		DI	2.0		V_{CC}	V	
V_{IL}	Input Low Voltage				GND		0.8	V
I_{IH}	Input High Current	$V_{IN} = 3.3V$ or 2.4V				± 2	± 10	μA
I_{IL}	Input Low Current	$V_{IN} = GND$ or 0.5V				± 1	± 10	μA
V_{CL}	Input Clamp Voltage	$I_{CL} = -18$ mA		-1.5	-0.6		V	
I_{CC}	Power Supply Current	No Load	$V_{IN} = V_{CC}$ or GND	V_{CC}		5	8	mA
		$R_L = 100\Omega$				7	10	mA

Switching Characteristics

Over Supply Voltage and Operating Temperature Ranges, unless otherwise specified. (Notes 3, 4, 5, 6)

Symbol	Parameter	Conditions	Min	Typ	Max	Units	
DIFFERENTIAL DRIVER CHARACTERISTICS							
t_{PHLD}	Differential Propagation Delay High to Low	$R_L = 100\Omega$, $C_L = 15$ pF (Figure 2 and Figure 3)	0.3	0.8	1.5	ns	
t_{PLHD}	Differential Propagation Delay Low to High		0.3	1.1	1.5	ns	
t_{SKD1}	Differential Pulse Skew $ t_{PHLD} - t_{PLHD} $ (Note 8)		0	0.3	0.7	ns	
t_{SKD3}	Differential Part to Part Skew (Note 9)		0		1.0	ns	
t_{SKD4}	Differential Part to Part Skew (Note 10)		0		1.2	ns	
t_{TLH}	Transition Low to High Time		0.2	0.5	1.0	ns	
t_{THL}	Transition High to Low Time		0.2	0.5	1.0	ns	
f_{MAX}	Maximum Operating Frequency (Note 11)				350		MHz

Note 1: "Absolute Maximum Ratings" are those values beyond which the safety of the device cannot be guaranteed. They are not meant to imply that the devices should be operated at these limits. The table of "Electrical Characteristics" specifies conditions of device operation.

Note 2: Current into device pins is defined as positive. Current out of device pins is defined as negative. All voltages are referenced to ground except V_{OD} .

Note 3: All typicals are given for: $V_{CC} = +3.3V$ and $T_A = +25^\circ C$.

Note 4: These parameters are guaranteed by design. The limits are based on statistical analysis of the device performance over PVT (process, voltage, temperature) ranges.

Note 5: C_L includes probe and fixture capacitance.

Switching Characteristics (Continued)

Note 6: Generator waveform for all tests unless otherwise specified: $f = 1 \text{ MHz}$, $Z_O = 50\Omega$, $t_r \leq 1 \text{ ns}$, $t_f \leq 1 \text{ ns}$ (10%-90%).

Note 7: The DS90LV017A is a current mode device and only function with datasheet specification when a resistive load is applied to the drivers outputs.

Note 8: t_{SKD1} , $|t_{PHLD} - t_{PLHD}|$, is the magnitude difference in differential propagation delay time between the positive going edge and the negative going edge of the same channel.

Note 9: t_{SKD3} , Differential Part to Part Skew, is defined as the difference between the minimum and maximum specified differential propagation delays. This specification applies to devices at the same V_{CC} and within 5°C of each other within the operating temperature range.

Note 10: t_{SKD4} , part to part skew, is the differential channel to channel skew of any event between devices. This specification applies to devices over recommended operating temperature and voltage ranges, and across process distribution. t_{SKD4} is defined as $I_{Max} - I_{Min}$ differential propagation delay.

Note 11: f_{MAX} generator input conditions: $t_r = t_f < 1 \text{ ns}$ (0% to 100%), 50% duty cycle, 0V to 3V. Output criteria: duty cycle = 45%/55%, $V_{OD} > 250\text{mV}$.

Parameter Measurement Information

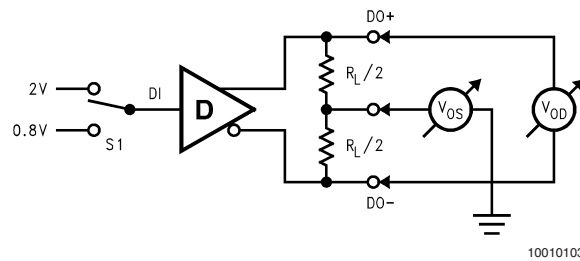

FIGURE 1. Differential Driver DC Test Circuit

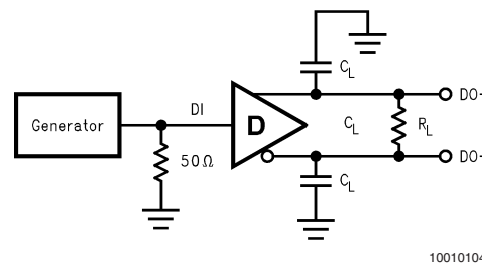

FIGURE 2. Differential Driver Propagation Delay and Transition Time Test Circuit

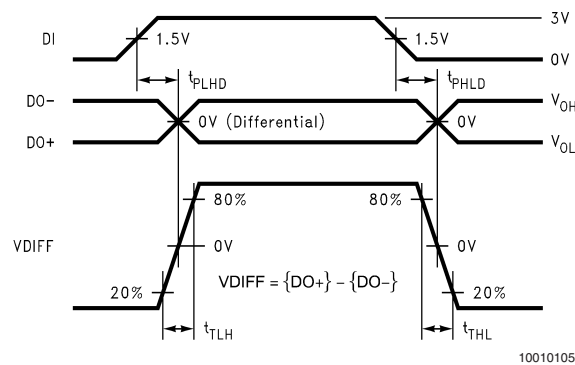

FIGURE 3. Differential Driver Propagation Delay and Transition Time Waveforms

Application Information

TABLE 1. Device Pin Descriptions

Pin #	Name	Description
2	DI1	TTL/CMOS driver input pins
7	DO1+	Non-inverting driver output pin
8	DO1-	Inverting driver output pin
4	GND	Ground pin
1	V _{CC}	Positive power supply pin, +3.3V ± 0.3V
3, 5, 6	NC	No connect

Typical Performance Curves

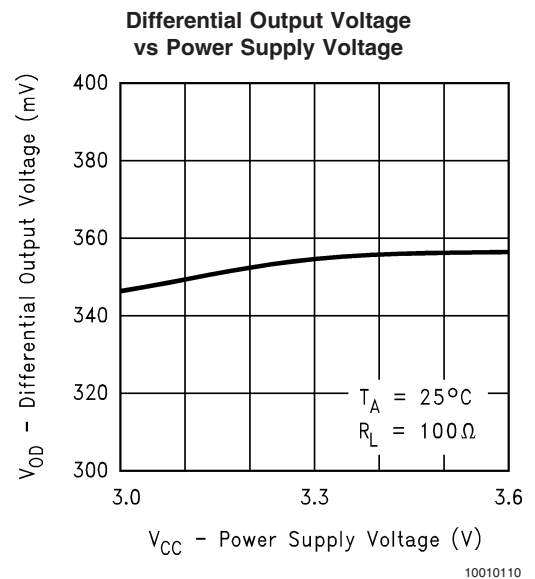
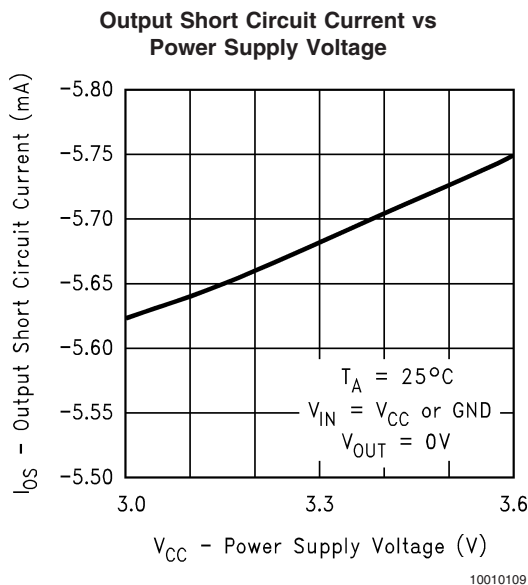
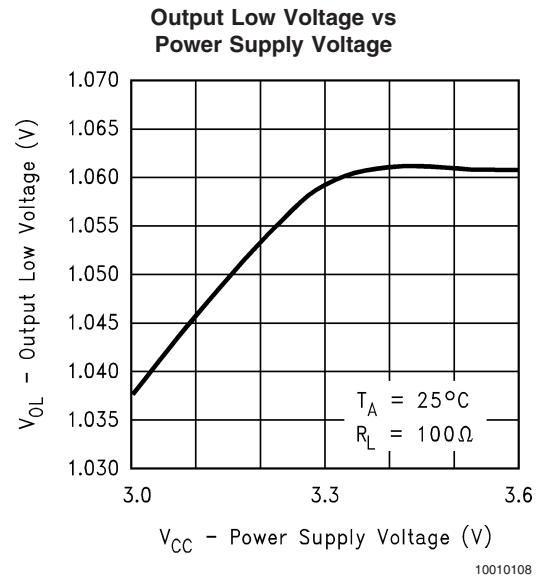
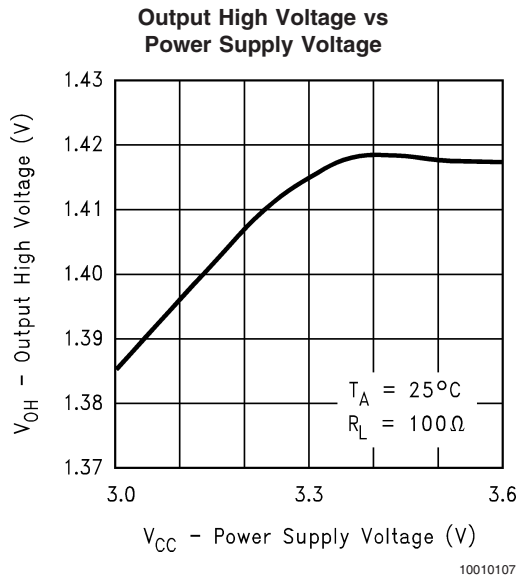

Typical Performance Curves (Continued)

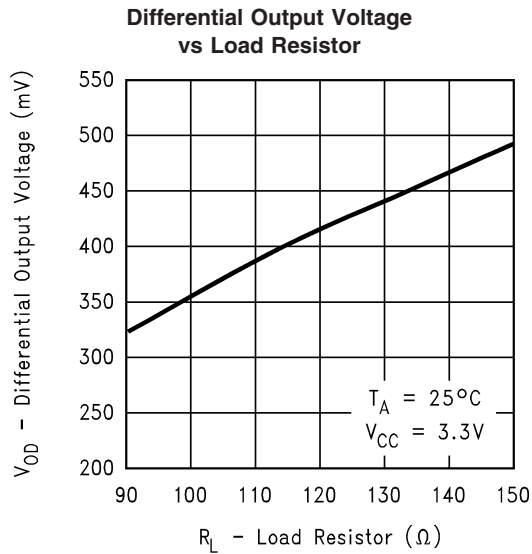

10010111

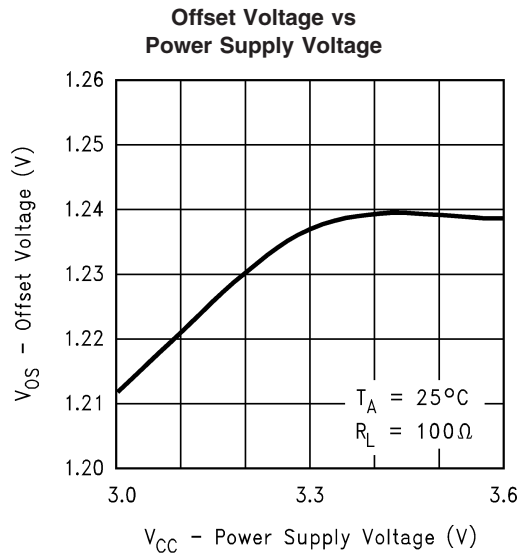

10010112

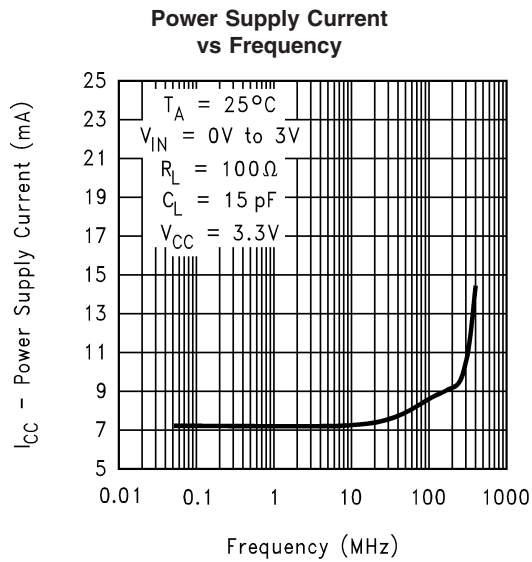

10010113

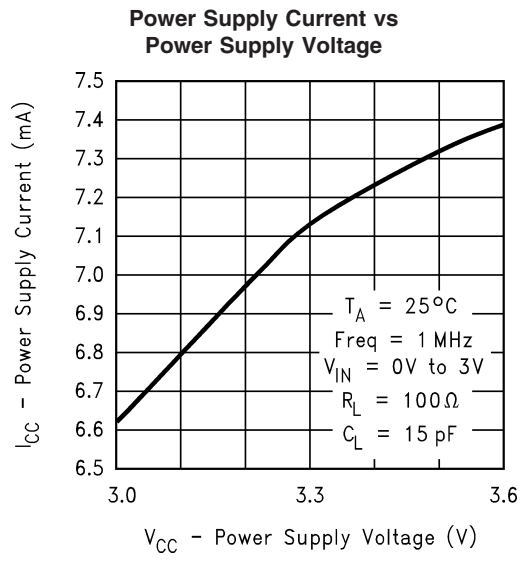

10010114

Typical Performance Curves (Continued)

Power Supply Current vs Ambient Temperature

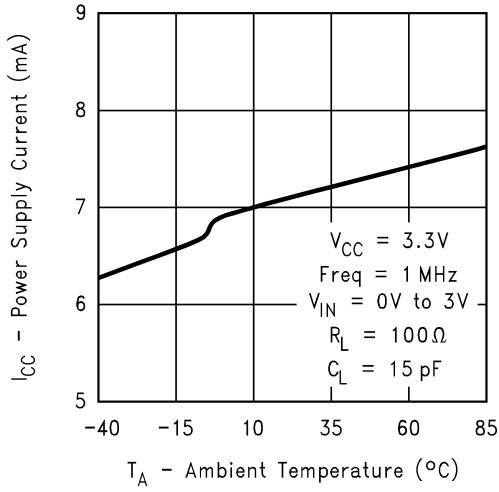

10010115

Differential Propagation Delay vs Power Supply Voltage

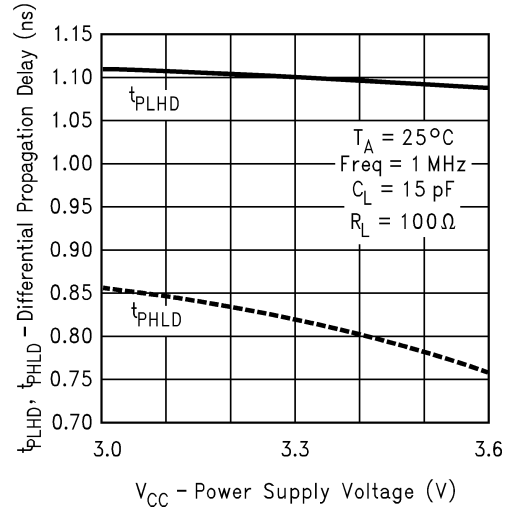

10010116

Differential Propagation Delay vs Ambient Temperature

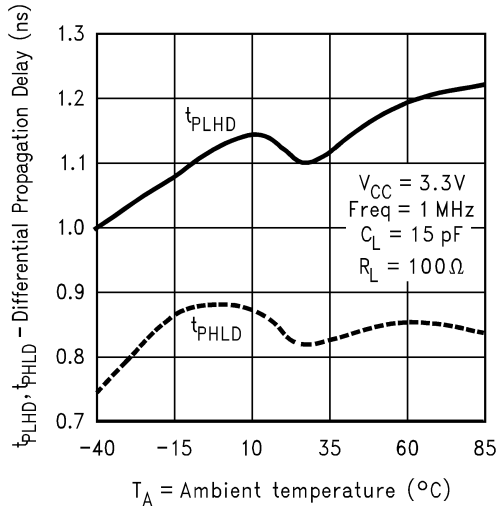

10010119

Differential Skew vs Power Supply Voltage

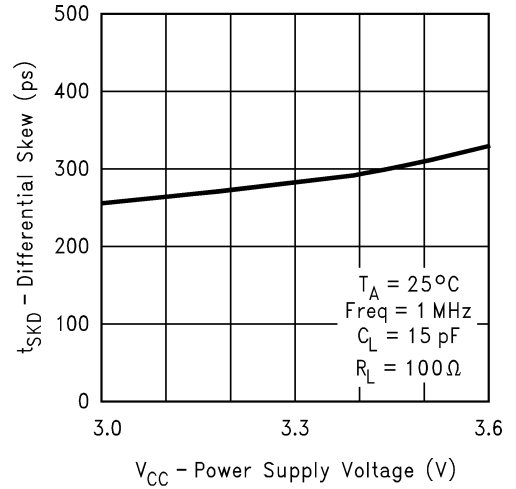

10010117

Typical Performance Curves (Continued)

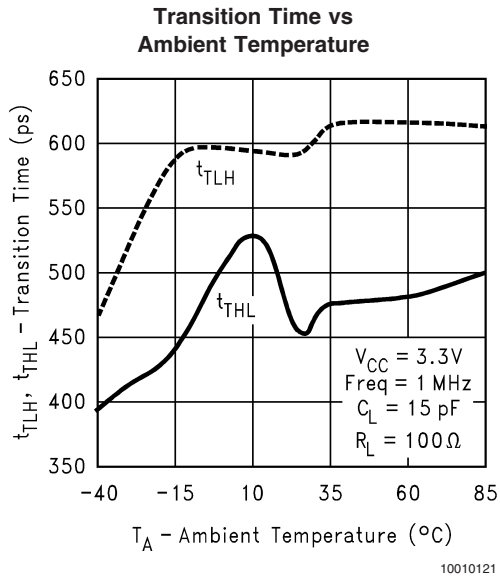
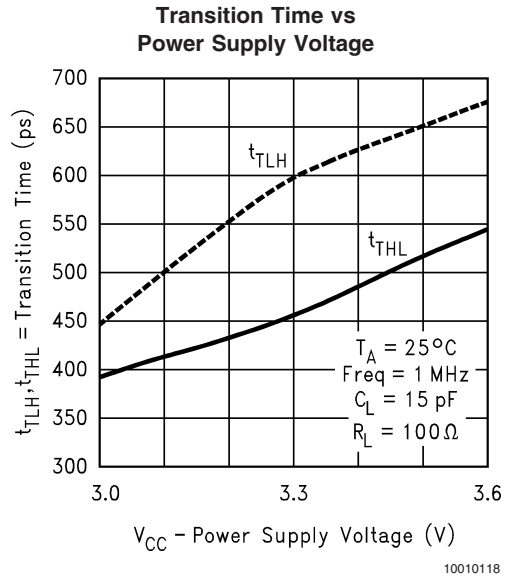
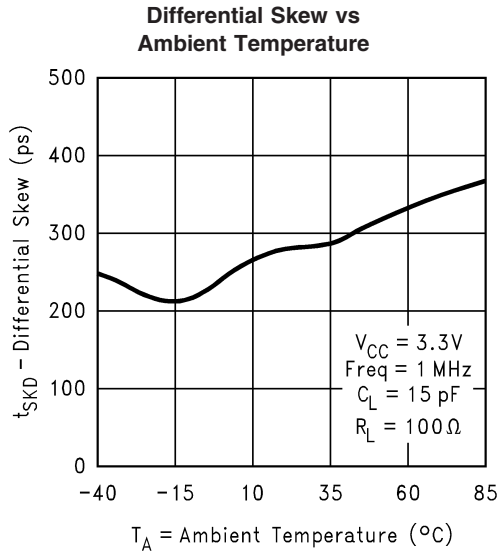

Physical Dimensions inches (millimeters) unless otherwise noted

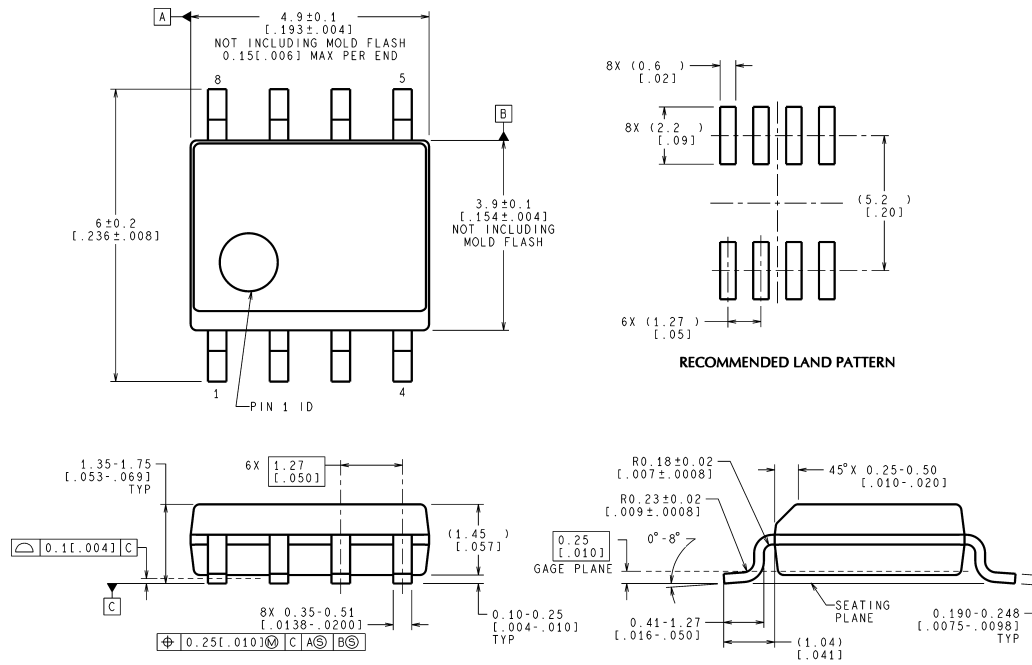

CONTROLLING DIMENSION IS MILLIMETER
VALUES IN [] ARE INCHES
DIMENSIONS IN () FOR REFERENCE ONLY

M08A (Rev K)

Order Number DS90LV017ATM
NS Package Number M08A

National does not assume any responsibility for use of any circuitry described, no circuit patent licenses are implied and National reserves the right at any time without notice to change said circuitry and specifications.

For the most current product information visit us at www.national.com.

LIFE SUPPORT POLICY

NATIONAL'S PRODUCTS ARE NOT AUTHORIZED FOR USE AS CRITICAL COMPONENTS IN LIFE SUPPORT DEVICES OR SYSTEMS WITHOUT THE EXPRESS WRITTEN APPROVAL OF THE PRESIDENT AND GENERAL COUNSEL OF NATIONAL SEMICONDUCTOR CORPORATION. As used herein:

- Life support devices or systems are devices or systems which, (a) are intended for surgical implant into the body, or (b) support or sustain life, and whose failure to perform when properly used in accordance with instructions for use provided in the labeling, can be reasonably expected to result in a significant injury to the user.
- A critical component is any component of a life support device or system whose failure to perform can be reasonably expected to cause the failure of the life support device or system, or to affect its safety or effectiveness.

BANNED SUBSTANCE COMPLIANCE

National Semiconductor manufactures products and uses packing materials that meet the provisions of the Customer Products Stewardship Specification (CSP-9-111C2) and the Banned Substances and Materials of Interest Specification (CSP-9-111S2) and contain no "Banned Substances" as defined in CSP-9-111S2.

Leadfree products are RoHS compliant.



National Semiconductor
Americas Customer
Support Center
Email: new.feedback@nsc.com
Tel: 1-800-272-9959

National Semiconductor
Europe Customer Support Center
Fax: +49 (0) 180-530 85 86
Email: europa.support@nsc.com
Deutsch Tel: +49 (0) 69 9508 6208
English Tel: +44 (0) 870 24 0 2171
Français Tel: +33 (0) 1 41 91 8790

National Semiconductor
Asia Pacific Customer
Support Center
Email: ap.support@nsc.com

National Semiconductor
Japan Customer Support Center
Fax: 81-3-5639-7507
Email: jpn.feedback@nsc.com
Tel: 81-3-5639-7560

www.national.com