

“Underlined blue text” links to the corresponding page on the right.

TABLE of CONTENTS

01 - Mini-Line EE20 - 0.08VA-0.5VA	
<u>EE20 / 4 - 0.08VA</u>	2
<u>EE20 / 6.1 - 0.35VA</u>	3
<u>EE20 / 10 - 0.50VA</u>	4
02 - Print-Line EI30 - 0.5VA-2.8 VA	
<u>EI30 / 5 - 0.5VA</u>	5
<u>EI30 / 10.5 - 1VA</u>	6
<u>EI30 / 12.5 - 1.2VA</u>	7
<u>EI30 / 12.5 - 1.5VA</u>	8
<u>EI30 / 15.5 - 2VA</u>	9
<u>EI30 / 18 - 2.3VA</u>	10
<u>EI30 / 23 - 2.8VA</u>	11
03 - Print-Line EI38 - 3.2VA-4VA	
<u>EI38 / 13.6 - 3.2VA</u>	12
<u>EI38 / 13.6 - 4VA</u>	13
04 - Print-Line EI42-EI54 - 5VA-16VA	
<u>EI42 / 14.8 - 5VA</u>	14
<u>EI48 / 16.8 - 10VA</u>	15
<u>EI54 / 18.8 - 16VA</u>	16
05 - Transformers with mounting brackets - 5VA-50VA	
<u>EI42 / 14.8 - 5VA</u>	17
<u>EI48 / 16.8 - 10VA</u>	18
<u>EI54 / 18.8 - 16VA</u>	19
<u>EI60 / 25.5 - 25VA</u>	20
<u>EI66 / 23 - 36VA</u>	21
<u>EI66 / 34.7 - 50VA</u> (230V)	22
<u>EI66 / 34.7 - 50VA</u> (2x115V)	23
06 - Low Profile Transformers - 2VA-30VA	
<u>UI30 / 5.5 - 2VA</u>	24
<u>UI30 / 7.5 - 4VA</u>	25
<u>UI30 / 10.5 - 6VA</u>	26
<u>UI30 / 16.5 - 10VA</u>	27
<u>UI39 / 8 - 10VA</u>	28
<u>UI39 / 10.2 - 14VA</u>	29
<u>UI39 / 13.5 - 18VA</u>	30
<u>UI39 / 17 - 24VA</u>	31
<u>UI39 / 21 - 30VA</u>	32
07 - Compact Power Supplies - 8.4VA-60VA	
<u>EI48 / 16.8</u> (AC)	33
<u>EI48 / 16.8</u> (DC)	33
<u>EI66 / 23</u>	34
<u>EI84 / 29.5</u>	34
08 - Ignition Transformers	
<u>Spark-Line</u> - 233-375mH	35
<u>Spark-Line</u> - Secondary external (1x)	36
<u>Spark-Line</u> - Secondary external (2x)	37

LAMINATED TRANSFORMERS

Type EE20 / 4 - 0.08VA









AGENCY APPROVALS 

1. UL 506, File E113449 

2. UL 1585, File E175197 

Primary (V)	Secondary (V / mA)	No-Load Voltage (V)	Schematic No.	Part Number	Agency Approvals
230	6 / 13.30	9.20	1	020-5480.0	1/2
230	9 / 8.88	13.60	1	020-5481.0	1/2
230	12 / 6.67	18.30	1	020-5482.0	1/2
230	15 / 5.33	22.60	1	020-5483.0	1/2
230	18 / 4.44	27.20	1	020-5484.0	1/2
115	6 / 13.3	9.20	1	020-5470.0	1/2
115	9 / 8.88	13.60	1	020-5471.0	1/2
115	12 / 6.67	18.30	1	020-5472.0	1/2
115	15 / 5.33	22.60	1	020-5473.0	1/2
115	18 / 4.44	27.20	1	020-5474.0	1/2

-  Frequency 50/60Hz
-  Potted under vacuum
-  Split-bobbin
-  Temperature class ta 70°C/B
-  Short-circuit-proof (where noted: 1/2/3* under Agency Approvals)
-  Weight: 0.018kg
-  Packaging unit: 40 pieces (tray)

Mechanical

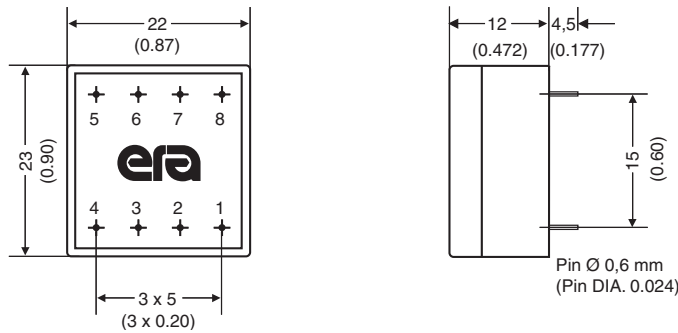

Schematic

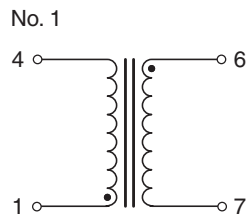



LAMINATED TRANSFORMERS

Type EE20 / 6.1 - 0.35VA









AGENCY APPROVALS 

1. UL 506, File E113449  **Class 2/3**

2. UL 1585, File E175197  **Class 2/3**

3. EN61558 

-  Frequency 50/60Hz
-  Potted under vacuum
-  Split-bobbin
-  Temperature class ta 70°C/B
-  Short-circuit-proof (where noted: 1/2/3* under Agency Approvals)
-  Weight: 0.024kg
-  Packaging unit: 40 pieces (tray)

Mechanical

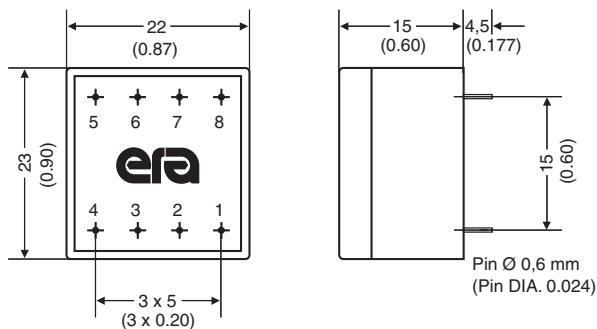

Primary (V)	Secondary (V / mA)	No-Load Voltage (V)	Schematic No.	Part Number	Agency Approvals
230	6 / 58.0	10.80	1	020-5423.0	1/2/3*
230	9 / 39.0	16.50	1	020-5424.0	1/2/3*
230	12 / 29.0	21.90	1	020-5425.0	1/2/3*
230	15 / 23.0	27.00	1	020-5426.0	1/2/3*
230	18 / 19.0	31.50	1	020-5427.0	1/2/3*
230	24 / 14.0	41.70	1	020-5428.0	1/2/3*
230	2x6 / 29.0	2x10.95	2	020-5429.0	1/2/3*
230	2x9 / 19.0	2x15.60	2	020-5430.0	1/2/3*
230	2x12 / 14.0	2x20.70	2	020-5431.0	1/2/3*
230	2x15 / 12.0	2x26.00	2	020-5432.0	1
230	2x18 / 9.5	2x31.20	2	020-5433.0	1
230	2x24 / 7.0	2x41.90	2	020-5434.0	1
115	6 / 58.0	10.80	1	020-5411.0	1/2/3*
115	9 / 39.0	16.50	1	020-5412.0	1/2/3*
115	12 / 29.0	21.90	1	020-5413.0	1/2/3*
115	15 / 23.0	27.00	1	020-5414.0	1/2/3*
115	18 / 19.0	31.50	1	020-5415.0	1/2/3*
115	24 / 14.0	41.70	1	020-5416.0	1/2/3*
115	2x6 / 29.0	2x10.95	2	020-5417.0	1/2/3*
115	2x9 / 19.0	2x15.60	2	020-5418.0	1/2/3*
115	2x12 / 14.0	2x20.70	2	020-5419.0	1/2/3*
115	2x15 / 12.0	2x26.00	2	020-5420.0	1
115	2x18 / 9.5	2x31.20	2	020-5421.0	1
115	2x24 / 7.0	2x41.90	2	020-5422.0	1

*NOTE: When checking the approval status of this product with VDE, add the prefix "BV" and the suffix "M" to the orderable Part Number (these letters will also be found on the part label). The prefix and suffix are not part of the orderable Part Number.

Schematics

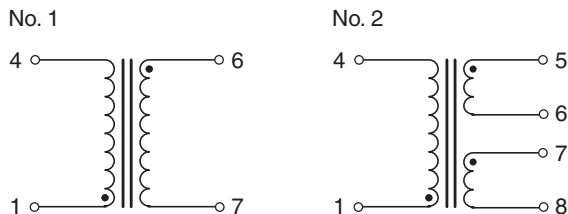





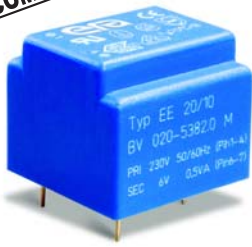



LAMINATED TRANSFORMERS

Type EE20 / 10 - 0.50VA



AGENCY APPROVALS 

1. UL 506, File E113449  **us**
2. UL 1585, File E175197 **Class 2/3**
3. EN61558 

-  Frequency 50/60Hz
-  Potted under vacuum
-  Split-bobbin
-  Temperature class ta 70°C/B
-  Short-circuit-proof (where noted: 1/2/3* under Agency Approvals)
-  Weight: 0.035kg
-  Packaging unit: 40 pieces (tray)

Primary (V)	Secondary (V / mA)	No-Load Voltage (V)	Schematic No.	Part Number	Agency Approvals
230	6 / 83	8.90	1	020-5382.0	1/2/3*
230	9 / 55	13.50	1	020-5383.0	1/2/3*
230	12 / 42	19.40	1	020-5384.0	1/2/3*
230	15 / 34	24.60	1	020-5385.0	1/2/3*
230	18 / 28	29.50	1	020-5386.0	1/2/3*
230	24 / 21	39.60	1	020-5387.0	1/2/3*
230	2x6 / 42	2x9.60	2	020-5388.0	1/2/3*
230	2x9 / 28	2x15.20	2	020-5389.0	1/2/3*
230	2x12 / 21	2x19.10	2	020-5390.0	1/2/3*
230	2x15 / 16	2x23.30	2	020-5391.0	1/2/3*
230	2x18 / 14	2x29.2	2	020-5392.0	1
230	2x24 / 10	2x38.8	2	020-5393.0	1
115	6 / 83	8.90	1	020-5370.0	1/2/3*
115	9 / 55	13.50	1	020-5371.0	1/2/3*
115	12 / 42	19.40	1	020-5372.0	1/2/3*
115	15 / 34	24.60	1	020-5373.0	1/2/3*
115	18 / 28	29.50	1	020-5374.0	1/2/3*
115	24 / 21	39.60	1	020-5375.0	1/2/3*
115	2x6 / 42	2x9.60	2	020-5376.0	1/2/3*
115	2x9 / 28	2x15.20	2	020-5377.0	1/2/3*
115	2x12 / 21	2x19.10	2	020-5378.0	1/2/3*
115	2x15 / 16	2x23.30	2	020-5379.0	1/2/3*
115	2x18 / 14	2x29.20	2	020-5380.0	1
115	2x24 / 10	2x38.80	2	020-5381.0	1

Mechanical

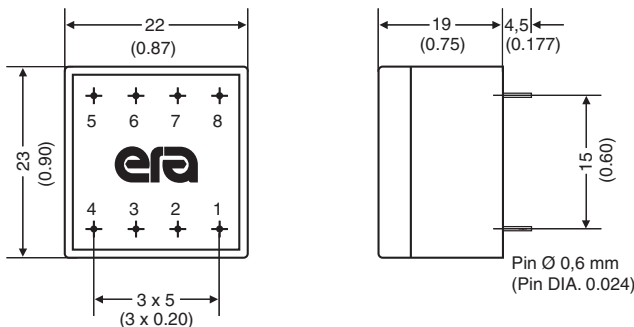

***NOTE:** When checking the approval status of this product with VDE, add the prefix "BV" and the suffix "M" to the orderable Part Number (these letters will also be found on the part label). **The prefix and suffix are not part of the orderable Part Number.**

Schematics

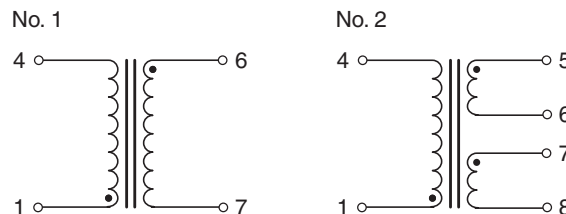

LAMINATED TRANSFORMERS

Type EI30 / 5 - 0.5VA









AGENCY APPROVALS 

1. UL 506, File E113449 

2. UL 1585, File E175197 

3. EN61558  

-  Frequency 50/60Hz
-  Potted under vacuum
-  Split-bobbin
-  Temperature class ta 70°C/B
-  Short-circuit-proof (where noted: 1/2/3* under Agency Approvals)
-  Weight: 0.06kg
-  Packaging unit: 25 pieces (tube)

Mechanical

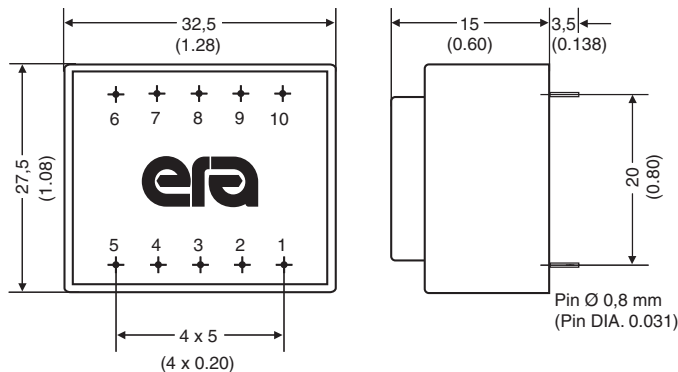

Schematics

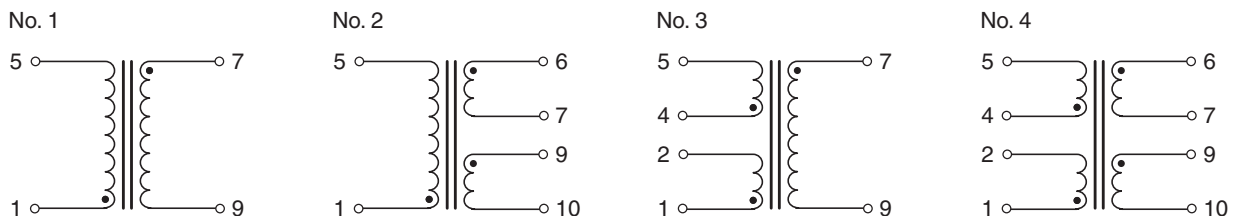

Primary (V)	Secondary (V / mA)	No-Load Voltage (V)	Schematic No.	Part Number	Agency Approvals
230	6 / 83	10.40	1	030-7196.0	1/2/3*
230	9 / 55	15.60	1	030-7197.0	1/2/3*
230	12 / 42	20.80	1	030-7198.0	1/2/3*
230	15 / 33	25.40	1	030-7199.0	1/2/3*
230	18 / 28	29.50	1	030-7200.0	1/2/3*
230	24 / 20	38.10	1	030-7201.0	1/2/3*
230	2x6 / 42	2x10.60	2	030-7202.0	1/2/3*
230	2x9 / 28	2x15.50	2	030-7203.0	1/2/3*
230	2x12 / 20	2x19.70	2	030-7204.0	1/2/3*
230	2x15 / 16	2x24.80	2	030-7205.0	1/2/3*
230	2x18 / 13	2x29.80	2	030-7206.0	1
230	2x24 / 10	2x39.10	2	030-7207.0	1
115	6 / 83	10.40	1	030-7184.0	1/2/3*
115	9 / 55	15.60	1	030-7185.0	1/2/3*
115	12 / 42	20.80	1	030-7186.0	1/2/3*
115	15 / 33	25.40	1	030-7187.0	1/2/3*
115	18 / 28	29.50	1	030-7188.0	1/2/3*
115	24 / 20	38.10	1	030-7189.0	1/2/3*
115	2x6 / 42	2x10.60	2	030-7190.0	1/2/3*
115	2x9 / 28	2x15.50	2	030-7191.0	1/2/3*
115	2x12 / 20	2x19.70	2	030-7192.0	1/2/3*
115	2x15 / 16	2x24.80	2	030-7193.0	1/2/3*
115	2x18 / 13	2x29.80	2	030-7194.0	1
115	2x24 / 10	2x39.10	2	030-7195.0	1
2x115	6 / 83	10.40	3	030-5325.0	1/2/3*
2x115	9 / 55	15.60	3	030-5328.0	1/2/3*
2x115	12 / 42	20.80	3	030-5331.0	1/2/3*
2x115	15 / 33	25.40	3	030-5334.0	1/2/3*
2x115	18 / 28	29.50	3	030-5337.0	1/2/3*
2x115	24 / 20	38.10	3	030-5343.0	1/2/3*
2x115	2x6 / 42	2x10.60	4	030-5348.0	1/2/3*
2x115	2x9 / 28	2x15.50	4	030-5351.0	1/2/3*
2x115	2x12 / 20	2x19.70	4	030-5354.0	1/2/3*
2x115	2x15 / 16	2x24.80	4	030-5357.0	1/2/3*
2x115	2x18 / 13	2x29.80	4	030-5360.0	1
2x115	2x24 / 10	2x39.10	4	030-5366.0	1

*NOTE: When checking the approval status of this product with VDE, add the prefix "BV" and the suffix "P" to the orderable Part Number (these letters will also be found on the part label). The prefix and suffix are not part of the orderable Part Number.

LAMINATED TRANSFORMERS



Type EI30 / 10.5 - 1.0VA









AGENCY APPROVALS 

1. UL 506, File E113449 

2. UL 1585, File E175197  (Class 2/3)

3. EN61558  

-  Frequency 50/60Hz
-  Potted under vacuum
-  Split-bobbin
-  Temperature class ta 70°C/B
-  Short-circuit-proof (where noted: 1/2/3* under Agency Approvals)
-  Weight: 0.07kg
-  Packaging unit: 35 pieces (tray)
25 pieces (tube)

Primary (V)	Secondary (V / mA)	No-Load Voltage (V)	Schematic No.	Part Number	Agency Approvals
230	6 / 166	8.50	1	030-7232.0	1/2/3*
230	9 / 111	12.45	1	030-7233.0	1/2/3*
230	12 / 84	16.30	1	030-7234.0	1/2/3*
230	15 / 66	20.20	1	030-7235.0	1/2/3*
230	18 / 55	24.20	1	030-7236.0	1/2/3*
230	24 / 42	32.20	1	030-7237.0	1/2/3*
230	2x6 / 84	2x8.30	2	030-7238.0	1/2/3*
230	2x9 / 55	2x11.90	2	030-7239.0	1/2/3*
230	2x12 / 42	2x16.20	2	030-7240.0	1/2/3*
230	2x15 / 33	2x20.40	2	030-7241.0	1/2/3*
230	2x18 / 28	2x24.20	2	030-7242.0	1
230	2x24 / 21	2x32.10	2	030-7243.0	1
115	6 / 166	8.50	1	030-7220.0	1/2/3*
115	9 / 111	12.45	1	030-7221.0	1/2/3*
115	12 / 84	16.30	1	030-7222.0	1/2/3*
115	15 / 66	20.20	1	030-7223.0	1/2/3*
115	18 / 55	24.20	1	030-7224.0	1/2/3*
115	24 / 42	32.20	1	030-7225.0	1/2/3*
115	2x6 / 84	2x8.30	2	030-7226.0	1/2/3*
115	2x9 / 55	2x11.90	2	030-7227.0	1/2/3*
115	2x12 / 42	2x16.20	2	030-7228.0	1/2/3*
115	2x15 / 33	2x20.40	2	030-7229.0	1/2/3*
115	2x18 / 28	2x24.20	2	030-7230.0	1
115	2x24 / 21	2x32.10	2	030-7231.0	1
2x115	6 / 166	8.50	3	030-5693.0	1/2/3*
2x115	9 / 111	12.45	3	030-5696.0	1/2/3*
2x115	12 / 84	16.30	3	030-5699.0	1/2/3*
2x115	15 / 66	20.20	3	030-5702.0	1/2/3*
2x115	18 / 55	24.20	3	030-5705.0	1/2/3*
2x115	24 / 42	32.20	3	030-5711.0	1/2/3*
2x115	2x6 / 84	2x8.30	4	030-5716.0	1/2/3*
2x115	2x9 / 55	2x11.90	4	030-5719.0	1/2/3*
2x115	2x12 / 42	2x16.20	4	030-5722.0	1/2/3*
2x115	2x15 / 33	2x20.40	4	030-5725.0	1/2/3*
2x115	2x18 / 28	2x24.20	4	030-5728.0	1
2x115	2x24 / 21	2x32.10	4	030-5734.0	1

Mechanical

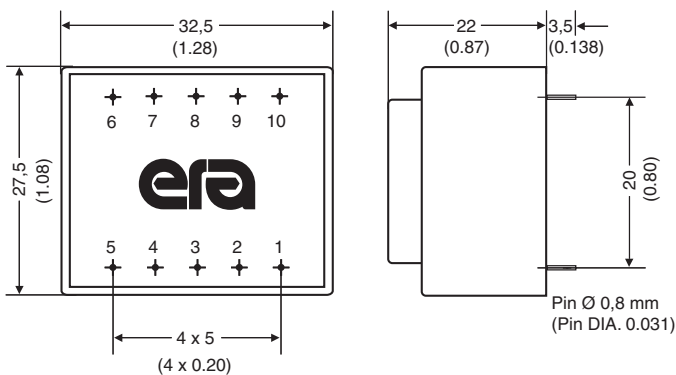

Schematics

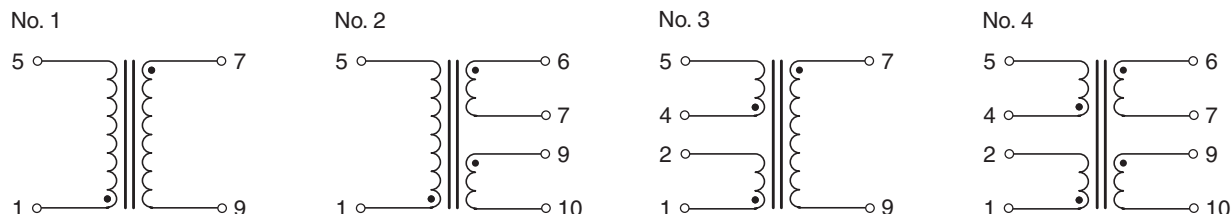



*NOTE: When checking the approval status of this product with VDE, add the prefix "BV" and the suffix "R" to the orderable Part Number (these letters will also be found on the part label). The prefix and suffix are not part of the orderable Part Number.

LAMINATED TRANSFORMERS



Type EI30 / 12.5 - 1.2VA









AGENCY APPROVALS 

1. UL 506, File E113449  

2. UL 1585, File E175197 [Class 2/3] 

3. EN61558  

-  Frequency 50/60Hz
-  Potted under vacuum
-  Split-bobbin
-  Temperature class ta 70°C/B
-  Short-circuit-proof (where noted: 1/2/3* under Agency Approvals)
-  Weight: 0.08kg
-  Packaging unit: 25 pieces (tube)

Mechanical

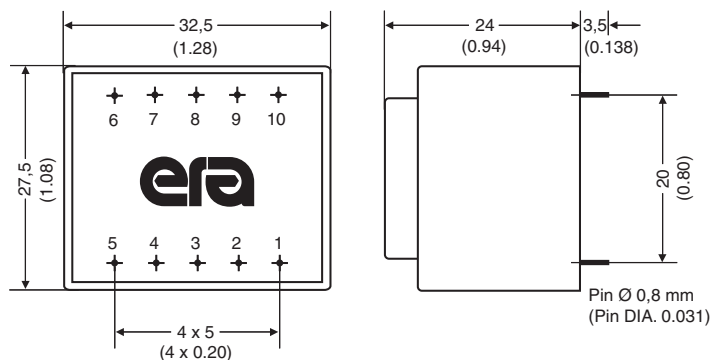

Schematics

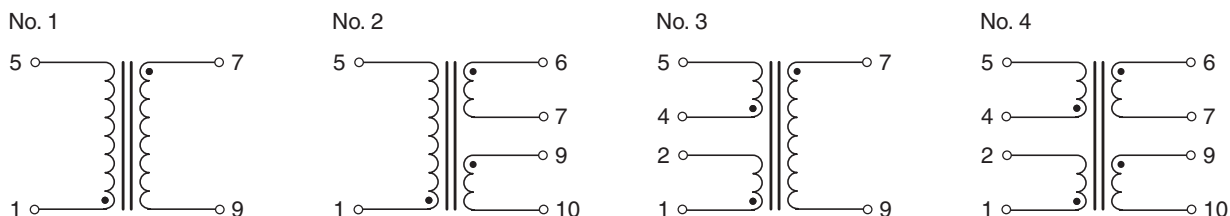

Primary (V)	Secondary (V / mA)	No-Load Voltage (V)	Schematic No.	Part Number	Agency Approvals
230	6 / 200	8.70	1	030-7268.0	1/2/3*
230	9 / 133	12.30	1	030-7269.0	1/2/3*
230	12 / 100	16.60	1	030-7270.0	1/2/3*
230	15 / 80	21.20	1	030-7271.0	1/2/3*
230	18 / 66	27.80	1	030-7272.0	1/2/3*
230	24 / 50	34.50	1	030-7273.0	1/2/3*
230	2x6 / 100	2x8.70	2	030-7274.0	1/2/3*
230	2x9 / 66	2x12.30	2	030-7275.0	1/2/3*
230	2x12 / 50	2x16.60	2	030-7276.0	1/2/3*
230	2x15 / 40	2x20.60	2	030-7277.0	1/2/3*
230	2x18 / 33	2x25.80	2	030-7278.0	1
230	2x24 / 25	2x32.90	2	030-7279.0	1
115	6 / 200	8.70	1	030-7256.0	1/2/3*
115	9 / 133	12.30	1	030-7257.0	1/2/3*
115	12 / 100	16.60	1	030-7258.0	1/2/3*
115	15 / 80	21.20	1	030-7259.0	1/2/3*
115	18 / 66	27.80	1	030-7260.0	1/2/3*
115	24 / 50	34.50	1	030-7261.0	1/2/3*
115	2x6 / 100	2x8.70	2	030-7262.0	1/2/3*
115	2x9 / 66	2x12.30	2	030-7263.0	1/2/3*
115	2x12 / 50	2x16.60	2	030-7264.0	1/2/3*
115	2x15 / 40	2x20.60	2	030-7265.0	1/2/3*
115	2x18 / 33	2x25.80	2	030-7266.0	1
115	2x24 / 25	2x32.90	2	030-7267.0	1
2x115	6 / 200	8.95	3	030-6061.0	1/2/3*
2x115	9 / 133	12.90	3	030-6064.0	1/2/3*
2x115	12 / 100	16.70	3	030-6067.0	1/2/3*
2x115	15 / 80	24.70	3	030-6070.0	1/2/3*
2x115	18 / 66	29.50	3	030-6073.0	1/2/3*
2x115	24 / 50	35.80	3	030-6079.0	1/2/3*
2x115	2x6 / 100	2x9.15	4	030-6084.0	1/2/3*
2x115	2x9 / 66	2x13.70	4	030-6087.0	1/2/3*
2x115	2x12 / 50	2x17.30	4	030-6090.0	1/2/3*
2x115	2x15 / 40	2x24.70	4	030-6093.0	1/2/3*
2x115	2x18 / 33	2x29.40	4	030-6096.0	1
2x115	2x24 / 25	2x35.80	4	030-6102.0	1

*NOTE: When checking the approval status of this product with VDE, add the prefix "BV" and the suffix "V" to the orderable Part Number (these letters will also be found on the part label). The prefix and suffix are not part of the orderable Part Number.

LAMINATED TRANSFORMERS

Type EI30 / 12.5 - 1.5VA









AGENCY APPROVALS 

1. UL 506, File E113449  **Class 2/3**

2. UL 1585, File E175197 

3. EN61558 

-  Frequency 50/60Hz
-  Potted under vacuum
-  Split-bobbin
-  Temperature class ta 70°C/B
-  Short-circuit-proof (where noted: 1/2/3* under Agency Approvals)
-  Weight: 0.08kg
-  Packaging unit: 25 pieces (tube)

Mechanical

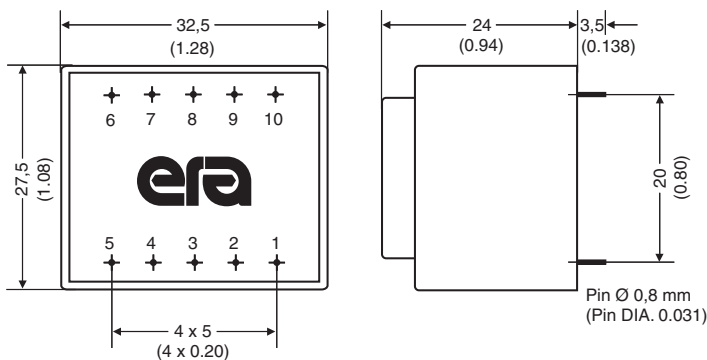

Schematics

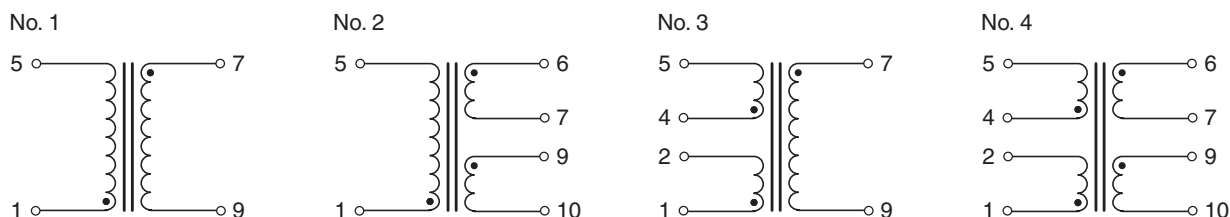

Primary (V)	Secondary (V / mA)	No-Load Voltage (V)	Schematic No.	Part Number	Agency Approvals
230	6 / 250	8.95	1	030-7161.0	1/2/3*
230	9 / 166	12.90	1	030-7162.0	1/2/3*
230	12 / 125	16.70	1	030-7139.0	1/2/3*
230	15 / 100	24.70	1	030-7163.0	1/2/3*
230	18 / 83	29.50	1	030-7164.0	1/2/3*
230	24 / 62	35.80	1	030-7165.0	1/2/3*
230	2x6 / 125	2x9.15	2	030-7166.0	1/2/3*
230	2x9 / 83	2x13.70	2	030-7167.0	1/2/3*
230	2x12 / 62	2x17.30	2	030-7168.0	1/2/3*
230	2x15 / 50	2x24.70	2	030-7169.0	1/2/3*
230	2x18 / 41	2x29.40	2	030-7170.0	1
230	2x24 / 31	2x35.80	2	030-7171.0	1
115	6 / 250	8.95	1	030-7150.0	1/2/3*
115	9 / 166	12.90	1	030-7151.0	1/2/3*
115	12 / 125	16.70	1	030-7136.0	1/2/3*
115	15 / 100	24.70	1	030-7152.0	1/2/3*
115	18 / 83	29.50	1	030-7153.0	1/2/3*
115	24 / 62	35.80	1	030-7154.0	1/2/3*
115	2x6 / 125	2x9.15	2	030-7155.0	1/2/3*
115	2x9 / 83	2x13.70	2	030-7156.0	1/2/3*
115	2x12 / 62	2x17.30	2	030-7157.0	1/2/3*
115	2x15 / 50	2x24.70	2	030-7158.0	1/2/3*
115	2x18 / 41	2x29.40	2	030-7159.0	1
115	2x24 / 31	2x35.80	2	030-7160.0	1
2x115	6 / 250	8.95	3	030-7711.0	1/2/3*
2x115	9 / 166	12.90	3	030-7712.0	1/2/3*
2x115	12 / 125	16.70	3	030-7713.0	1/2/3*
2x115	15 / 100	24.70	3	030-7714.0	1/2/3*
2x115	18 / 83	29.50	3	030-7715.0	1/2/3*
2x115	24 / 62	35.80	3	030-7716.0	1/2/3*
2x115	2x6 / 125	2x9.15	4	030-7717.0	1/2/3*
2x115	2x9 / 83	2x13.70	4	030-7718.0	1/2/3*
2x115	2x12 / 62	2x17.30	4	030-7719.0	1/2/3*
2x115	2x15 / 50	2x24.70	4	030-7720.0	1/2/3*
2x115	2x18 / 41	2x29.40	4	030-7721.0	1
2x115	2x24 / 31	2x35.80	4	030-7722.0	1

*NOTE: When checking the approval status of this product with VDE, add the prefix "BV" and the suffix "N" to the orderable Part Number (these letters will also be found on the part label). The prefix and suffix are not part of the orderable Part Number.

LAMINATED TRANSFORMERS

Type EI30 / 15.5 - 2.0VA



- Frequency 50/60Hz
- Potted under vacuum
- Split-bobbin
- Temperature class ta 70°C/B
- Weight: 0.10kg
- Packaging unit: 25 pieces (tube)

Mechanical

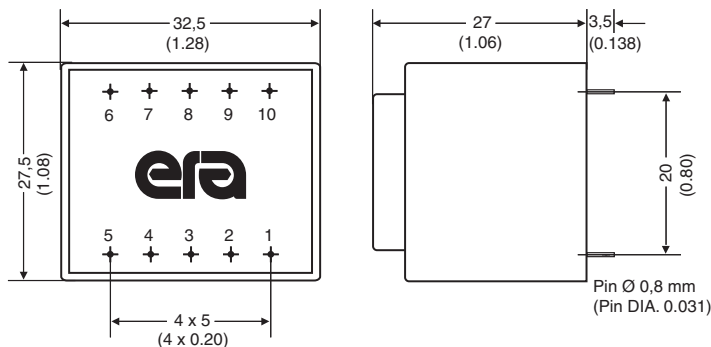

Schematics

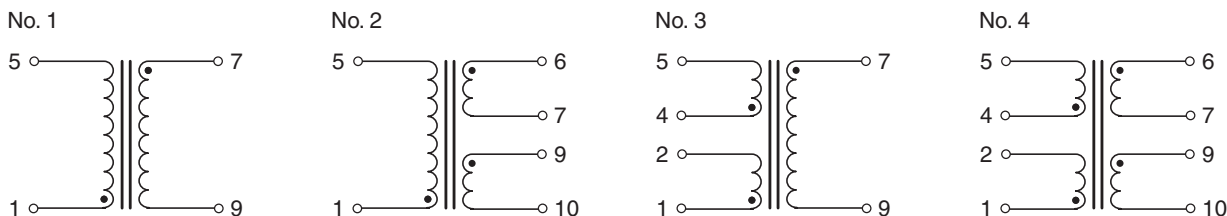

Primary (V)	Secondary (V / mA)	No-Load Voltage (V)	Schematic No.	Part Number	Agency Approvals
230	6 / 333	10.50	1	030-7304.0	1/3*
230	9 / 222	14.60	1	030-7305.0	1/3*
230	12 / 166	20.00	1	030-7306.0	1/3*
230	15 / 133	26.00	1	030-7307.0	1/3*
230	18 / 111	29.60	1	030-7308.0	1/3*
230	24 / 83	37.20	1	030-7309.0	1/3*
230	2x6 / 166	2x8.70	2	030-7310.0	1/3*
230	2x9 / 111	2x14.60	2	030-7311.0	1/3*
230	2x12 / 83	2x19.45	2	030-7312.0	1/3*
230	2x15 / 66	2x24.10	2	030-7313.0	1/3*
230	2x18 / 55	2x29.10	2	030-7314.0	1
230	2x24 / 42	2x36.50	2	030-7315.0	1
115	6 / 333	10.50	1	030-7292.0	1/3*
115	9 / 222	14.60	1	030-7293.0	1/3*
115	12 / 166	20.00	1	030-7294.0	1/3*
115	15 / 133	26.00	1	030-7295.0	1/3*
115	18 / 111	29.60	1	030-7296.0	1/3*
115	24 / 83	37.20	1	030-7297.0	1/3*
115	2x6 / 166	2x8.70	2	030-7298.0	1/3*
115	2x9 / 111	2x14.60	2	030-7299.0	1/3*
115	2x12 / 83	2x19.45	2	030-7300.0	1/3*
115	2x15 / 66	2x24.10	2	030-7301.0	1/3*
115	2x18 / 55	2x29.10	2	030-7302.0	1
115	2x24 / 42	2x36.50	2	030-7303.0	1
2x115	6 / 333	10.50	3	030-6429.0	1/3*
2x115	9 / 222	14.60	3	030-6432.0	1/3*
2x115	12 / 166	20.00	3	030-6435.0	1/3*
2x115	15 / 133	26.00	3	030-6438.0	1/3*
2x115	18 / 111	29.60	3	030-6441.0	1/3*
2x115	24 / 83	37.20	3	030-6447.0	1/3*
2x115	2x6 / 166	2x8.70	4	030-6452.0	1/3*
2x115	2x9 / 111	2x14.60	4	030-6455.0	1/3*
2x115	2x12 / 83	2x19.45	4	030-6458.0	1/3*
2x115	2x15 / 66	2x24.10	4	030-6461.0	1/3*
2x115	2x18 / 55	2x29.10	4	030-6464.0	1
2x115	2x24 / 42	2x36.50	4	030-6470.0	1

*NOTE: When checking the approval status of this product with VDE, add the prefix "BV" and the suffix "S" to the orderable Part Number (these letters will also be found on the part label). The prefix and suffix are **not** part of the orderable Part Number.

LAMINATED TRANSFORMERS







Type EI30 / 18.0 - 2.3VA



AGENCY APPROVALS 

1. UL 506, File E113449 

3. EN61558 

-  Frequency 50/60Hz
-  Potted under vacuum
-  Split-bobbin
-  Temperature class ta 70°C/B
-  Weight: 0.112kg
-  Packaging unit: 25 pieces (tube)

Mechanical

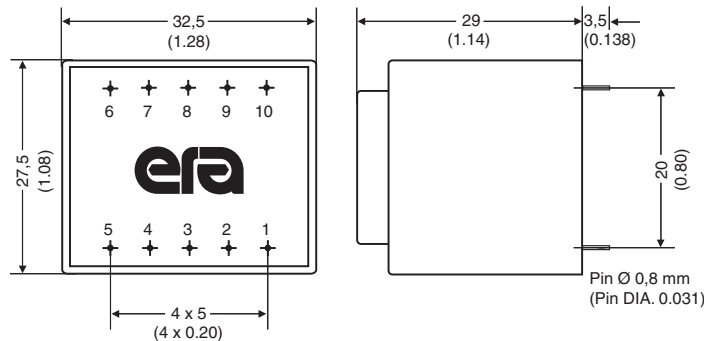

Schematics

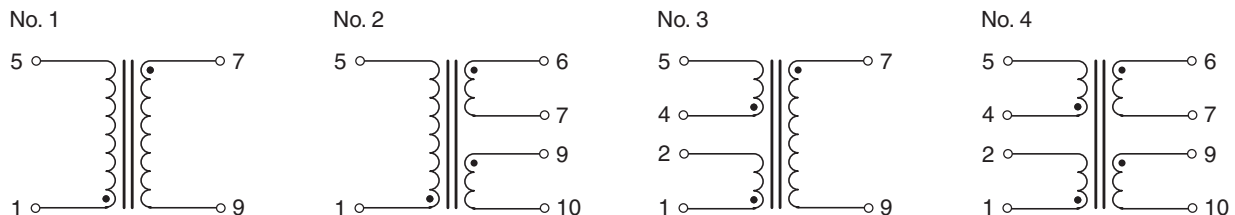

Primary (V)	Secondary (V / mA)	No-Load Voltage (V)	Schematic No.	Part Number	Agency Approvals
230	6 / 384	10.00	1	030-7340.0	1/3*
230	9 / 256	13.80	1	030-7341.0	1/3*
230	12 / 192	18.60	1	030-7342.0	1/3*
230	15 / 154	23.80	1	030-7343.0	1/3*
230	18 / 128	27.80	1	030-7344.0	1/3*
230	24 / 96	34.70	1	030-7345.0	1/3*
230	2x6 / 192	2x9.90	2	030-7346.0	1/3*
230	2x9 / 128	2x14.00	2	030-7347.0	1/3*
230	2x12 / 96	2x17.50	2	030-7348.0	1/3*
230	2x15 / 77	2x24.40	2	030-7349.0	1/3*
230	2x18 / 64	2x29.30	2	030-7350.0	1
230	2x24 / 48	2x35.80	2	030-7351.0	1
115	6 / 384	10.00	1	030-7328.0	1/3*
115	9 / 256	13.80	1	030-7329.0	1/3*
115	12 / 192	18.60	1	030-7330.0	1/3*
115	15 / 154	23.80	1	030-7331.0	1/3*
115	18 / 128	27.80	1	030-7332.0	1/3*
115	24 / 96	34.70	1	030-7333.0	1/3*
115	2x6 / 192	2x9.90	2	030-7334.0	1/3*
115	2x9 / 128	2x14.00	2	030-7335.0	1/3*
115	2x12 / 96	2x17.50	2	030-7336.0	1/3*
115	2x15 / 77	2x24.40	2	030-7337.0	1/3*
115	2x18 / 64	2x29.30	2	030-7338.0	1
115	2x24 / 48	2x35.80	2	030-7339.0	1
2x115	6 / 384	10.00	3	030-6797.0	1/3*
2x115	9 / 256	13.80	3	030-6800.0	1/3*
2x115	12 / 192	18.60	3	030-6803.0	1/3*
2x115	15 / 154	23.80	3	030-6806.0	1/3*
2x115	18 / 128	27.80	3	030-6809.0	1/3*
2x115	24 / 96	34.70	3	030-6815.0	1/3*
2x115	2x6 / 192	2x9.90	4	030-6820.0	1/3*
2x115	2x9 / 128	2x14.00	4	030-6823.0	1/3*
2x115	2x12 / 96	2x17.50	4	030-6826.0	1/3*
2x115	2x15 / 77	2x24.40	4	030-6829.0	1/3*
2x115	2x18 / 64	2x29.30	4	030-6832.0	1
2x115	2x24 / 48	2x35.80	4	030-6838.0	1







*NOTE: When checking the approval status of this product with VDE, add the prefix "BV" and the suffix "T" to the orderable Part Number (these letters will also be found on the part label). The prefix and suffix are not part of the orderable Part Number.

LAMINATED TRANSFORMERS

Type EI30 / 23.0 - 2.8VA



AGENCY APPROVALS 
 1. UL 506, File E113449 
 3. EN61558 

-  Frequency 50/60Hz
-  Potted under vacuum
-  Split-bobbin
-  Temperature class ta 70°C/B
-  Weight: 0.134kg
-  Packaging unit: 25 pieces (tube)

Primary (V)	Secondary (V / mA)	No-Load Voltage (V)	Schematic No.	Part Number	Agency Approvals
230	6 / 466	10.70	1	030-7584.0	1/3*
230	9 / 311	14.80	1	030-7585.0	1/3*
230	12 / 233	20.80	1	030-7586.0	1/3*
230	15 / 186	24.00	1	030-7587.0	1/3*
230	18 / 155	29.90	1	030-7588.0	1/3*
230	24 / 116	38.80	1	030-7589.0	1/3*
230	2x6 / 233	2x10.70	2	030-7590.0	1/3*
230	2x9 / 155	2x16.00	2	030-7591.0	1/3*
230	2x12 / 116	2x20.40	2	030-7592.0	1/3*
230	2x15 / 93	2x25.00	2	030-7593.0	1/3*
230	2x18 / 77	2x30.50	2	030-7594.0	1
230	2x24 / 58	2x38.70	2	030-7595.0	1
115	6 / 466	10.70	1	030-7596.0	1/3*
115	9 / 311	14.80	1	030-7597.0	1/3*
115	12 / 233	20.80	1	030-7598.0	1/3*
115	15 / 186	24.00	1	030-7599.0	1/3*
115	18 / 155	29.90	1	030-7600.0	1/3*
115	24 / 116	38.80	1	030-7601.0	1/3*
115	2x6 / 233	2x10.70	2	030-7602.0	1/3*
115	2x9 / 155	2x16.00	2	030-7603.0	1/3*
115	2x12 / 116	2x20.40	2	030-7604.0	1/3*
115	2x15 / 93	2x25.00	2	030-7605.0	1/3*
115	2x18 / 77	2x30.50	2	030-7606.0	1
115	2x24 / 58	2x38.70	2	030-7607.0	1
2x115	6 / 466	10.70	3	030-7723.0	1/3*
2x115	9 / 311	14.80	3	030-7724.0	1/3*
2x115	12 / 233	20.80	3	030-7725.0	1/3*
2x115	15 / 186	24.00	3	030-7726.0	1/3*
2x115	18 / 155	29.90	3	030-7727.0	1/3*
2x115	24 / 116	38.80	3	030-7728.0	1/3*
2x115	2x6 / 233	2x10.70	4	030-7729.0	1/3*
2x115	2x9 / 155	2x16.00	4	030-7730.0	1/3*
2x115	2x12 / 116	2x20.40	4	030-7731.0	1/3*
2x115	2x15 / 93	2x25.00	4	030-7732.0	1/3*
2x115	2x18 / 77	2x30.50	4	030-7733.0	1
2x115	2x24 / 58	2x38.70	4	030-7734.0	1

Mechanical

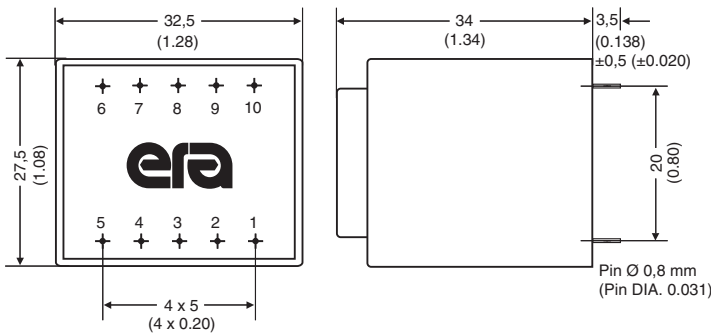

Schematics

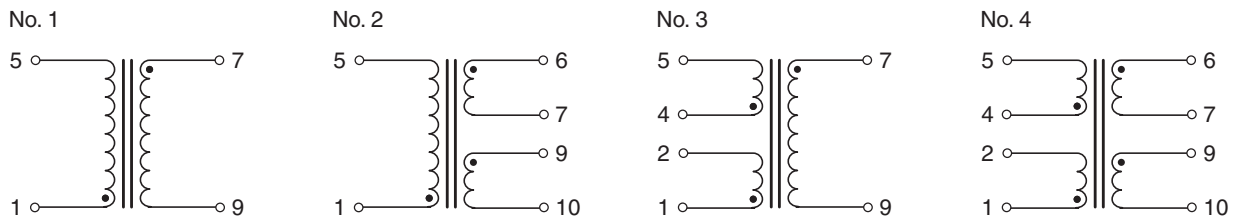

*NOTE: When checking the approval status of this product with VDE, add the prefix "BV" and the suffix "U" to the orderable Part Number (these letters will also be found on the part label). The prefix and suffix are **not** part of the orderable Part Number.

LAMINATED TRANSFORMERS







Type EI38 / 13.6 - 3.2VA



AGENCY APPROVALS 

1. UL 506, File E113449 

3. EN61558 

-  Frequency 50/60Hz
-  Potted under vacuum
-  Split-bobbin
-  Temperature class ta 70°C/B
-  Weight: 0.155kg
-  Packaging unit: 25 pieces (tray)

Mechanical

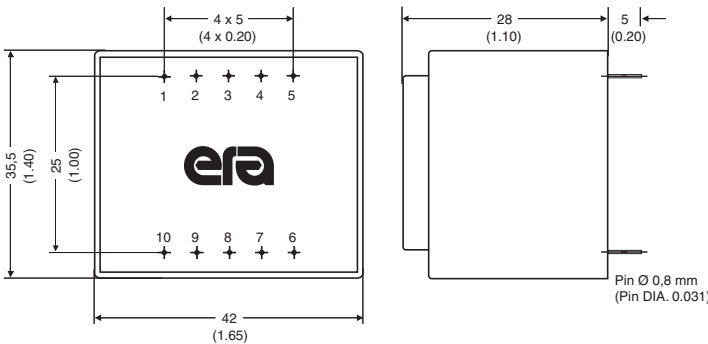

Schematics

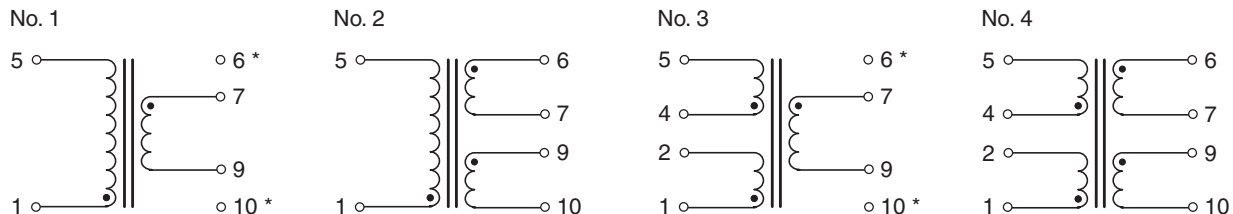

* Empty-Pin



Primary (V)	Secondary (V / mA)	No-Load Voltage (V)	Schematic No.	Part Number	Agency Approvals
230	6 / 534	9.20	1	038-5187.0	1/3*
230	9 / 356	13.95	1	038-5190.0	1/3*
230	12 / 267	17.80	1	038-5193.0	1/3*
230	15 / 214	22.20	1	038-5196.0	1/3*
230	18 / 178	27.00	1	038-5199.0	1/3*
230	24 / 134	35.00	1	038-5205.0	1/3*
230	2x6 / 267	2x8.90	2	038-5210.0	1/3*
230	2x9 / 178	2x13.40	2	038-5213.0	1/3*
230	2x12 / 134	2x17.50	2	038-5216.0	1/3*
230	2x15 / 107	2x22.30	2	038-5219.0	1/3*
230	2x18 / 89	2x25.80	2	038-5222.0	1
230	2x24 / 67	2x35.90	2	038-5228.0	1
115	6 / 534	9.20	1	038-5049.0	1/3*
115	9 / 356	13.95	1	038-5052.0	1/3*
115	12 / 267	17.80	1	038-5055.0	1/3*
115	15 / 214	22.20	1	038-5058.0	1/3*
115	18 / 178	27.00	1	038-5061.0	1/3*
115	24 / 134	35.00	1	038-5067.0	1/3*
115	2x6 / 267	2x8.90	2	038-5072.0	1/3*
115	2x9 / 178	2x13.40	2	038-5075.0	1/3*
115	2x12 / 134	2x17.50	2	038-5078.0	1/3*
115	2x15 / 107	2x22.30	2	038-5081.0	1/3*
115	2x18 / 89	2x25.80	2	038-5084.0	1
115	2x24 / 67	2x35.90	2	038-5090.0	1
2x115	6 / 534	9.20	3	038-5325.0	1/3*
2x115	9 / 356	13.95	3	038-5328.0	1/3*
2x115	12 / 267	17.80	3	038-5331.0	1/3*
2x115	15 / 214	22.20	3	038-5334.0	1/3*
2x115	18 / 178	27.00	3	038-5337.0	1/3*
2x115	24 / 134	35.00	3	038-5343.0	1/3*
2x115	2x6 / 267	2x8.90	4	038-5348.0	1/3*
2x115	2x9 / 178	2x13.40	4	038-5351.0	1/3*
2x115	2x12 / 134	2x17.50	4	038-5354.0	1/3*
2x115	2x15 / 107	2x22.30	4	038-5357.0	1/3*
2x115	2x18 / 89	2x25.80	4	038-5360.0	1
2x115	2x24 / 67	2x35.90	4	038-5366.0	1

*NOTE: When checking the approval status of this product with VDE, add the prefix "BV" and the suffix "F" to the orderable Part Number (these letters will also be found on the part label). The prefix and suffix are not part of the orderable Part Number.

LAMINATED TRANSFORMERS







Type EI38 / 13.6 - 4.0VA



AGENCY APPROVALS   

1. UL 506, File E113449 

3. EN61558 

-  Frequency 50/60Hz
-  Potted under vacuum
-  Split-bobbin
-  Temperature class ta 70°C/B
-  Weight: 0.155kg
-  Packaging unit: 25 pieces (tray)

Mechanical

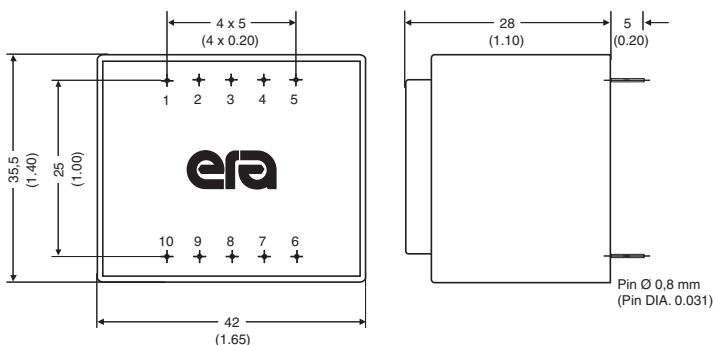

Schematics

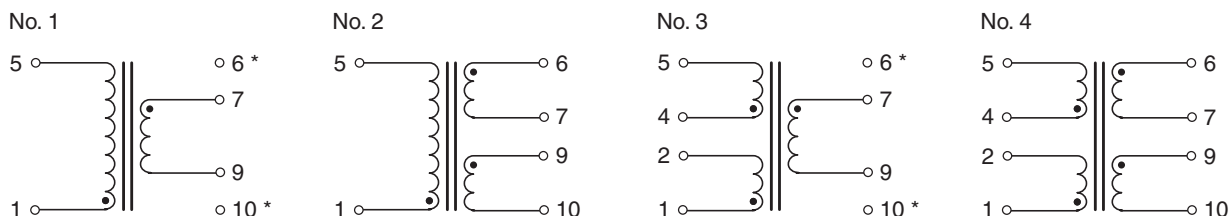

* Empty-Pin

Primary (V)	Secondary (V / mA)	No-Load Voltage (V)	Schematic No.	Part Number	Agency Approvals
230	6 / 667	8.50	1	038-5412.0	1/3*
230	9 / 444	12.60	1	038-5413.0	1/3*
230	12 / 333	16.40	1	038-5414.0	1/3*
230	15 / 267	20.90	1	038-5415.0	1/3*
230	18 / 222	24.30	1	038-5416.0	1/3*
230	24 / 167	32.80	1	038-5417.0	1/3*
230	2x6 / 333	2x8.50	2	038-5418.0	1/3*
230	2x9 / 222	2x12.50	2	038-5419.0	1/3*
230	2x12 / 167	2x16.40	2	038-5420.0	1/3*
230	2x15 / 133	2x21.20	2	038-5421.0	1/3*
230	2x18 / 111	2x24.50	2	038-5422.0	1/3*
230	2x24 / 83	2x32.70	2	038-5423.0	1
115	6 / 667	8.50	1	038-5400.0	1/3*
115	9 / 444	12.60	1	038-5401.0	1/3*
115	12 / 333	16.40	1	038-5402.0	1/3*
115	15 / 267	20.90	1	038-5403.0	1/3*
115	18 / 222	24.30	1	038-5404.0	1/3*
115	24 / 167	32.80	1	038-5405.0	1/3*
115	2x6 / 333	2x8.50	2	038-5406.0	1/3*
115	2x9 / 222	2x12.50	2	038-5407.0	1/3*
115	2x12 / 167	2x16.40	2	038-5408.0	1/3*
115	2x15 / 133	2x21.20	2	038-5409.0	1/3*
115	2x18 / 111	2x24.50	2	038-5410.0	1/3*
115	2x24 / 83	2x32.70	2	038-5411.0	1
2x115	6 / 667	8.50	3	038-5424.0	1/3*
2x115	9 / 444	12.60	3	038-5425.0	1/3*
2x115	12 / 333	16.40	3	038-5426.0	1/3*
2x115	15 / 267	20.90	3	038-5427.0	1/3*
2x115	18 / 222	24.30	3	038-5428.0	1/3*
2x115	24 / 167	32.80	3	038-5429.0	1/3*
2x115	2x6 / 333	2x8.50	4	038-5430.0	1/3*
2x115	2x9 / 222	2x12.50	4	038-5431.0	1/3*
2x115	2x12 / 167	2x16.40	4	038-5432.0	1/3*
2x115	2x15 / 133	2x21.20	4	038-5433.0	1/3*
2x115	2x18 / 111	2x24.50	4	038-5434.0	1/3*
2x115	2x24 / 83	2x32.70	4	038-5435.0	1

*NOTE: When checking the approval status of this product with VDE, add the prefix "BV" and the suffix "F" to the orderable Part Number (these letters will also be found on the part label). The prefix and suffix are not part of the orderable Part Number.

LAMINATED TRANSFORMERS







Type EI42 / 14.8 - 5.0VA



AGENCY APPROVALS 

1. UL 506, File E113449  

3. EN61558  

-  Frequency 50/60Hz
-  Potted under vacuum
-  Split-bobbin
-  Temperature class ta 70°C/B
-  Weight: 0.2kg
-  Packaging unit: 25 pieces (tray)

Mechanical

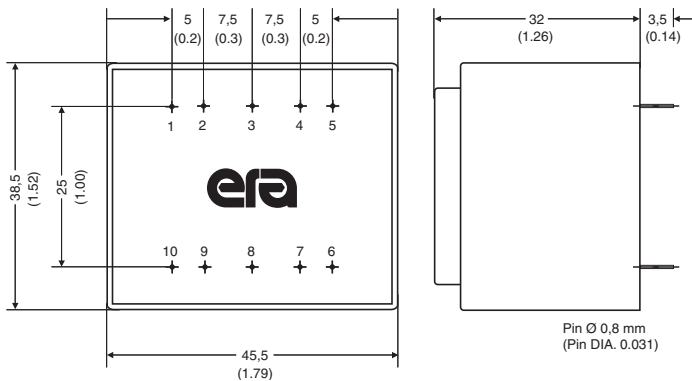

Schematics

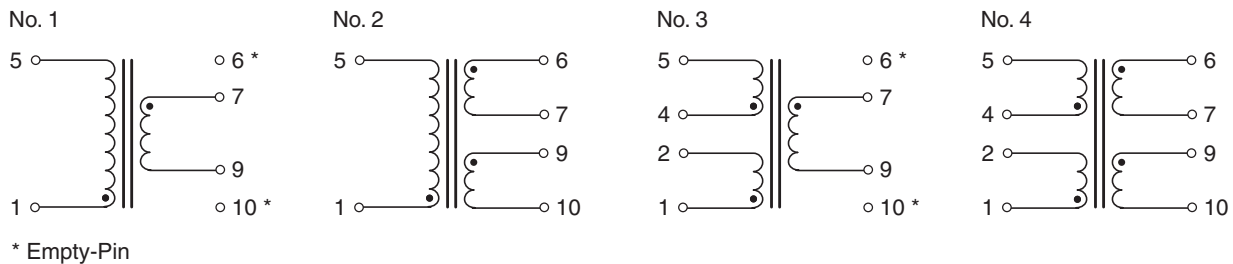

Primary (V)	Secondary (V / mA)	No-Load Voltage (V)	Schematic No.	Part Number	Agency Approvals
230	6 / 834	8.10	1	042-5187.0	1/3*
230	9 / 556	12.00	1	042-5190.0	1/3*
230	12 / 417	15.50	1	042-5193.0	1/3*
230	15 / 334	19.20	1	042-5196.0	1/3*
230	18 / 278	23.00	1	042-5199.0	1/3*
230	24 / 208	30.50	1	042-5205.0	1/3*
230	2x6 / 417	2x7.70	2	042-5210.0	1/3*
230	2x9 / 278	2x11.60	2	042-5213.0	1/3*
230	2x12 / 208	2x15.20	2	042-5216.0	1/3*
230	2x15 / 167	2x19.40	2	042-5219.0	1/3*
230	2x18 / 139	2x23.10	2	042-5222.0	1/3*
230	2x24 / 104	2x30.80	2	042-5228.0	1
115	6 / 834	8.10	1	042-5049.0	1/3*
115	9 / 556	12.00	1	042-5052.0	1/3*
115	12 / 417	15.50	1	042-5055.0	1/3*
115	15 / 334	19.20	1	042-5058.0	1/3*
115	18 / 278	23.00	1	042-5061.0	1/3*
115	24 / 208	30.50	1	042-5067.0	1/3*
115	2x6 / 417	2x7.70	2	042-5072.0	1/3*
115	2x9 / 278	2x11.60	2	042-5075.0	1/3*
115	2x12 / 208	2x15.20	2	042-5078.0	1/3*
115	2x15 / 167	2x19.40	2	042-5081.0	1/3*
115	2x18 / 139	2x23.10	2	042-5084.0	1/3*
115	2x24 / 104	2x30.80	2	042-5090.0	1
2x115	6 / 834	8.10	3	042-5325.0	1/3*
2x115	9 / 556	12.00	3	042-5328.0	1/3*
2x115	12 / 417	15.50	3	042-5331.0	1/3*
2x115	15 / 334	19.20	3	042-5334.0	1/3*
2x115	18 / 278	23.00	3	042-5337.0	1/3*
2x115	24 / 208	30.50	3	042-5343.0	1/3*
2x115	2x6 / 417	2x7.70	4	042-5348.0	1/3*
2x115	2x9 / 278	2x11.60	4	042-5351.0	1/3*
2x115	2x12 / 208	2x15.20	4	042-5354.0	1/3*
2x115	2x15 / 167	2x19.40	4	042-5357.0	1/3*
2x115	2x18 / 139	2x23.10	4	042-5360.0	1/3*
2x115	2x24 / 104	2x30.80	4	042-5366.0	1

*NOTE: When checking the approval status of this product with VDE, add the prefix "BV" and the suffix "G" to the orderable Part Number (these letters will also be found on the part label). The prefix and suffix are not part of the orderable Part Number.

LAMINATED TRANSFORMERS







Type EI48 / 16.8 - 10VA



AGENCY APPROVALS   

1. UL 506, File E113449

3. EN61558

-  Frequency 50/60Hz
-  Potted under vacuum
-  Split-bobbin
-  Temperature class ta 40°C/B
-  Weight: 0.295kg
-  Packaging unit: 15 pieces (tray)

Mechanical

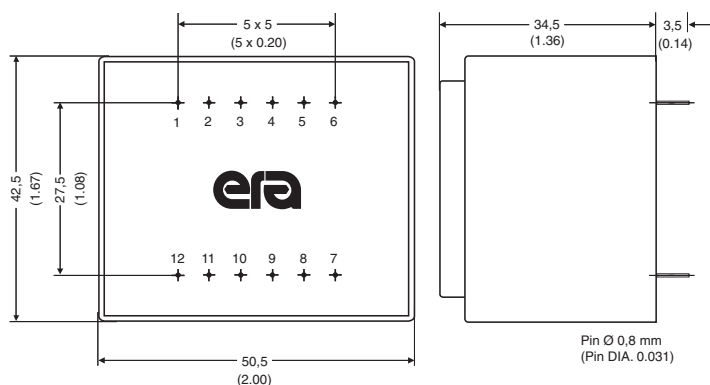

Schematics

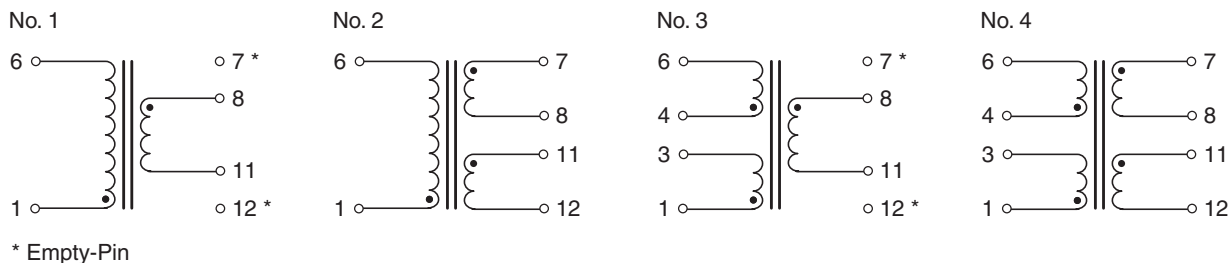

Primary (V)	Secondary (V / mA)	No-Load Voltage (V)	Schematic No.	Part Number	Agency Approvals
230	6 / 1666	7.90	1	048-5187.0	1/3*
230	9 / 1111	12.00	1	048-5190.0	1/3*
230	12 / 834	15.70	1	048-5193.0	1/3*
230	15 / 666	19.20	1	048-5196.0	1/3*
230	18 / 555	22.90	1	048-5199.0	1/3*
230	24 / 416	30.60	1	048-5205.0	1/3*
230	2x6 / 834	2x8.10	2	048-5210.0	1/3*
230	2x9 / 555	2x11.60	2	048-5213.0	1/3*
230	2x12 / 416	2x15.70	2	048-5216.0	1/3*
230	2x15 / 333	2x19.50	2	048-5219.0	1/3*
230	2x18 / 277	2x23.50	2	048-5222.0	1/3*
230	2x24 / 208	2x30.00	2	048-5228.0	1
115	6 / 1666	7.90	1	048-5049.0	1/3*
115	9 / 1111	12.00	1	048-5052.0	1/3*
115	12 / 834	15.70	1	048-5055.0	1/3*
115	15 / 666	19.20	1	048-5058.0	1/3*
115	18 / 555	22.90	1	048-5061.0	1/3*
115	24 / 416	30.60	1	048-5067.0	1/3*
115	2x6 / 834	2x8.10	2	048-5072.0	1/3*
115	2x9 / 555	2x11.60	2	048-5075.0	1/3*
115	2x12 / 416	2x15.70	2	048-5078.0	1/3*
115	2x15 / 333	2x19.50	2	048-5081.0	1/3*
115	2x18 / 277	2x23.50	2	048-5084.0	1/3*
115	2x24 / 208	2x30.00	2	048-5090.0	1
2x115	6 / 1666	7.90	3	048-5325.0	1/3*
2x115	9 / 1111	12.00	3	048-5328.0	1/3*
2x115	12 / 834	15.70	3	048-5331.0	1/3*
2x115	15 / 666	19.20	3	048-5334.0	1/3*
2x115	18 / 555	22.90	3	048-5337.0	1/3*
2x115	24 / 416	30.60	3	048-5343.0	1/3*
2x115	2x6 / 834	2x8.10	4	048-5348.0	1/3*
2x115	2x9 / 555	2x11.60	4	048-5351.0	1/3*
2x115	2x12 / 416	2x15.70	4	048-5354.0	1/3*
2x115	2x15 / 333	2x19.50	4	048-5357.0	1/3*
2x115	2x18 / 277	2x23.50	4	048-5360.0	1/3*
2x115	2x24 / 208	2x30.00	4	048-5366.0	1

*NOTE: When checking the approval status of this product with VDE, add the prefix "BV" and the suffix "H" to the orderable Part Number (these letters will also be found on the part label). The prefix and suffix are **not** part of the orderable Part Number.

LAMINATED TRANSFORMERS







Type EI54 / 18.8 - 16VA



AGENCY APPROVALS   

1. UL 506, File E113449 

3. EN61558 

-  Frequency 50/60Hz
-  Potted under vacuum
-  Split-bobbin
-  Temperature class ta 40°C/B
-  Weight: 0.42kg
-  Packaging unit: 10 pieces (tray)

Mechanical

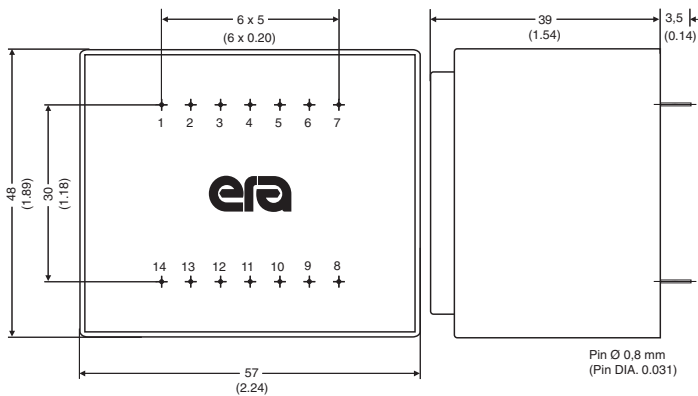

Schematics

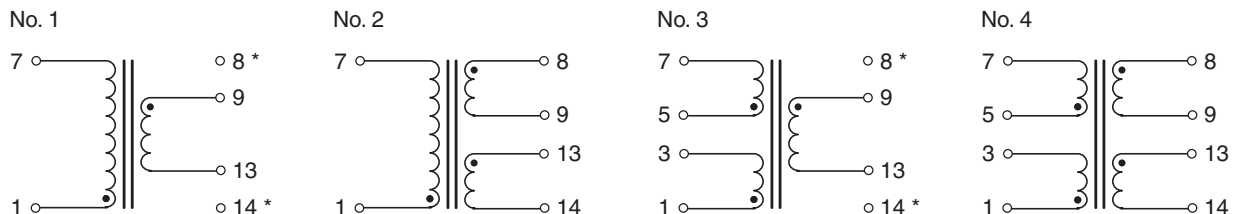

* Empty-Pin

Primary (V)	Secondary (V / mA)	No-Load Voltage (V)	Schematic No.	Part Number	Agency Approvals
230	6 / 2666	7.60	1	054-5187.0	1/3*
230	9 / 1777	11.30	1	054-5190.0	1/3*
230	12 / 1333	14.90	1	054-5193.0	1/3*
230	15 / 1066	18.40	1	054-5196.0	1/3*
230	18 / 888	22.40	1	054-5199.0	1/3*
230	24 / 666	29.60	1	054-5205.0	1/3*
230	2x6 / 1333	2x7.70	2	054-5210.0	1/3*
230	2x9 / 888	2x11.40	2	054-5213.0	1/3*
230	2x12 / 666	2x15.00	2	054-5216.0	1/3*
230	2x15 / 533	2x18.70	2	054-5219.0	1/3*
230	2x18 / 444	2x22.40	2	054-5222.0	1/3*
230	2x24 / 333	2x29.00	2	054-5228.0	1
115	6 / 2666	7.60	1	054-5049.0	1/3*
115	9 / 1777	11.30	1	054-5052.0	1/3*
115	12 / 1333	14.90	1	054-5055.0	1/3*
115	15 / 1066	18.40	1	054-5058.0	1/3*
115	18 / 888	22.40	1	054-5061.0	1/3*
115	24 / 666	29.60	1	054-5067.0	1/3*
115	2x6 / 1333	2x7.70	2	054-5072.0	1/3*
115	2x9 / 888	2x11.40	2	054-5075.0	1/3*
115	2x12 / 666	2x15.00	2	054-5078.0	1/3*
115	2x15 / 533	2x18.70	2	054-5081.0	1/3*
115	2x18 / 444	2x22.40	2	054-5084.0	1/3*
115	2x24 / 333	2x29.00	2	054-5090.0	1
2x115	6 / 2666	7.60	3	054-5325.0	1/3*
2x115	9 / 1777	11.30	3	054-5328.0	1/3*
2x115	12 / 1333	14.90	3	054-5331.0	1/3*
2x115	15 / 1066	18.40	3	054-5334.0	1/3*
2x115	18 / 888	22.40	3	054-5337.0	1/3*
2x115	24 / 666	29.60	3	054-5343.0	1/3*
2x115	2x6 / 1333	2x7.70	4	054-5348.0	1/3*
2x115	2x9 / 888	2x11.40	4	054-5351.0	1/3*
2x115	2x12 / 666	2x15.00	4	054-5354.0	1/3*
2x115	2x15 / 533	2x18.70	4	054-5357.0	1/3*
2x115	2x18 / 444	2x22.40	4	054-5360.0	1/3*
2x115	2x24 / 333	2x29.00	4	054-5366.0	1

*NOTE: When checking the approval status of this product with VDE, add the prefix "BV" and the suffix "K" to the orderable Part Number (these letters will also be found on the part label). The prefix and suffix are not part of the orderable Part Number.

LAMINATED TRANSFORMERS

Type EI42 / 14.8 - 5VA









AGENCY APPROVALS 

1. UL 506, File E113449  

3. EN61558  

Primary (V)	Secondary (V / mA)	No-Load Voltage (V)	Schematic No.	Part Number	Agency Approvals
230	6 / 834	8.10	1	042-5381.0	1/3*
230	9 / 556	12.00	1	042-5382.0	1/3*
230	12 / 417	15.50	1	042-5383.0	1/3*
230	15 / 334	19.20	1	042-5384.0	1/3*
230	18 / 278	23.20	1	042-5385.0	1/3*
230	24 / 208	30.50	1	042-5386.0	1/3*
230	2x6 / 417	2x7.80	2	042-5387.0	1/3*
230	2x9 / 278	2x11.60	2	042-5388.0	1/3*
230	2x12 / 208	2x15.20	2	042-5389.0	1/3*
230	2x15 / 167	2x19.40	2	042-5390.0	1/3*

-  Frequency 50/60Hz
-  Potted under vacuum
-  Split-bobbin
-  Temperature class ta 70°C/B
-  Weight: 0.2kg
-  Packaging unit: 15 pieces (tray)

***NOTE:** When checking the approval status of this product with VDE, add the prefix "BV" and the suffix "G" to the orderable Part Number (these letters will also be found on the part label). **The prefix and suffix are not part of the orderable Part Number.**

Mechanical

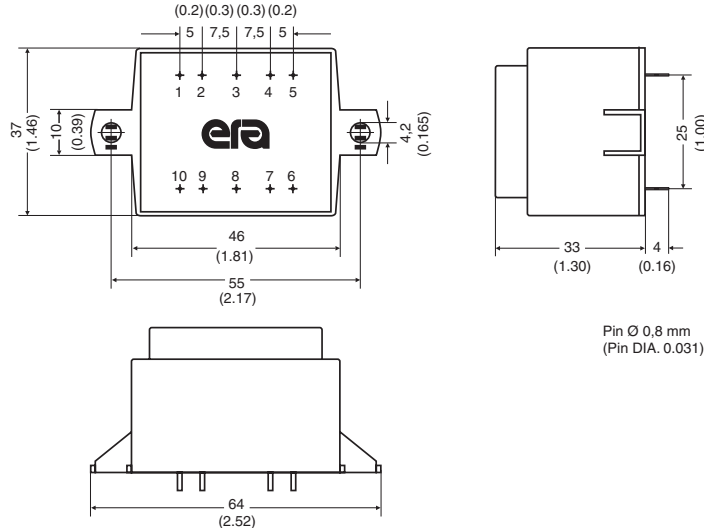

Schematics

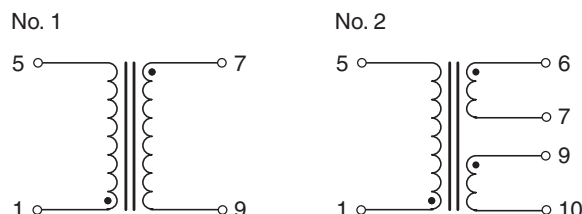

LAMINATED TRANSFORMERS

Type EI48 / 16.8 - 10VA



Primary (V)	Secondary (V / mA)	No-Load Voltage (V)	Schematic No.	Part Number	Agency Approvals
230	6 / 1666	7.90	1	048-5381.0	1/3*
230	9 / 1111	12.00	1	048-5382.0	1/3*
230	12 / 834	15.70	1	048-5383.0	1/3*
230	15 / 666	19.20	1	048-5384.0	1/3*
230	18 / 555	22.90	1	048-5385.0	1/3*
230	24 / 416	30.60	1	048-5386.0	1/3*
230	2x6 / 834	2x7.90	2	048-5387.0	1/3*
230	2x9 / 555	2x12.00	2	048-5388.0	1/3*
230	2x12 / 416	2x15.70	2	048-5389.0	1/3*
230	2x15 / 333	2x19.20	2	048-5390.0	1/3*

*NOTE: When checking the approval status of this product with VDE, add the prefix "BV" and the suffix "H" to the orderable Part Number (these letters will also be found on the part label). The prefix and suffix are not part of the orderable Part Number.

- ⊕ Frequency 50/60Hz
- ⊕ Potted under vacuum
- ⊕ Split-bobbin
- ⊕ Temperature class ta 40°C/B
- ⊕ Weight: 0.295kg
- ⊕ Packaging unit: 10 pieces (tray)

Mechanical

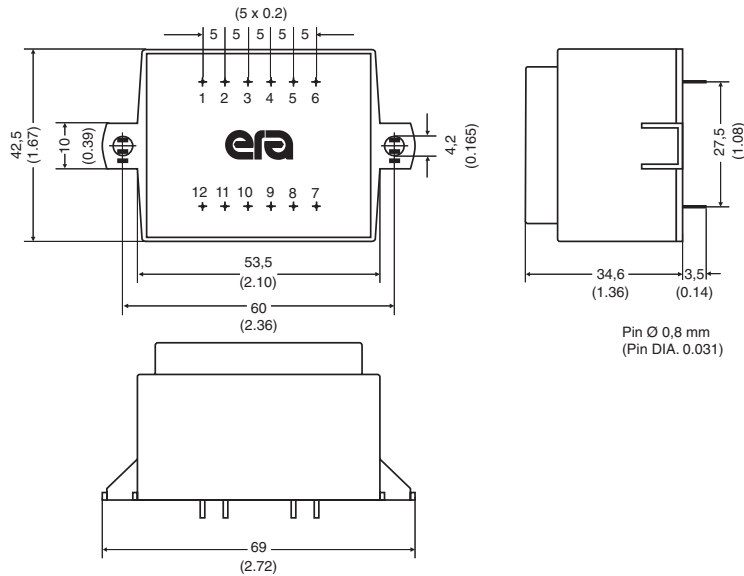

Schematics

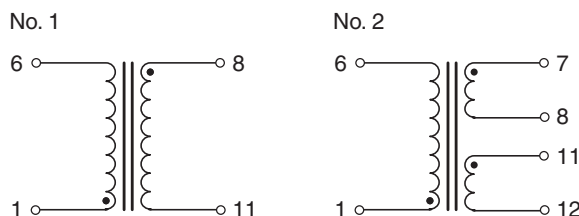

LAMINATED TRANSFORMERS

Type EI54 / 18.8 - 16VA









AGENCY APPROVALS   

1. UL 506, File E113449 

3. EN61558 

Primary (V)	Secondary (V / mA)	No-Load Voltage (V)	Schematic No.	Part Number	Agency Approvals
230	6 / 2666	7.60	1	054-5381.0	1/3*
230	9 / 1777	11.30	1	054-5382.0	1/3*
230	12 / 1333	14.90	1	054-5383.0	1/3*
230	15 / 1066	18.40	1	054-5384.0	1/3*
230	18 / 888	22.40	1	054-5385.0	1/3*
230	24 / 666	29.60	1	054-5386.0	1/3*
230	2x6 / 1333	2x7.70	2	054-5387.0	1/3*
230	2x9 / 888	2x11.40	2	054-5388.0	1/3*
230	2x12 / 666	2x15.00	2	054-5389.0	1/3*
230	2x15 / 533	2x18.70	2	054-5390.0	1/3*

*NOTE: When checking the approval status of this product with VDE, add the prefix "BV" and the suffix "K" to the orderable Part Number (these letters will also be found on the part label). The prefix and suffix are not part of the orderable Part Number.

-  Frequency 50/60Hz
-  Potted under vacuum
-  Split-bobbin
-  Temperature class ta 40°C/B
-  Weight: 0.43kg
-  Packaging unit: 10 pieces (tray)

Mechanical

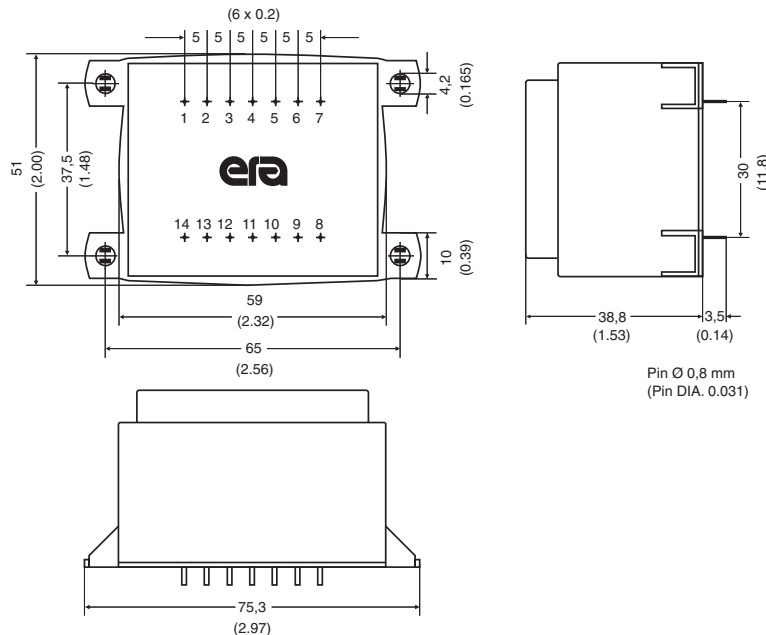

Schematics

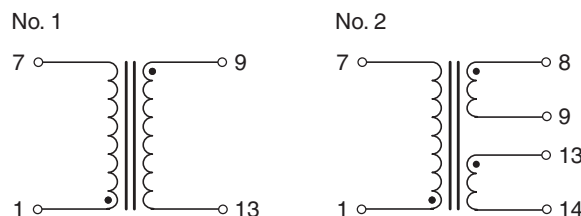

LAMINATED TRANSFORMERS

Type EI60 / 25.5 - 25VA



- Frequency 50/60Hz
- Potted under vacuum
- Split-bobbin
- Temperature class ta 40°C/B
- Weight: 0.67kg
- Packaging unit: 6 pieces (tray)

Primary (V)	Secondary (V / mA)	No-Load Voltage (V)	Schematic No.	Part Number	Agency Approvals
230	6 / 4170	6.90	1	060-0201.0	3*
230	9 / 2780	10.30	1	060-0202.0	3*
230	12 / 2080	13.60	1	060-0203.0	3*
230	15 / 1670	17.00	1	060-0204.0	3*
230	18 / 1390	20.50	1	060-0205.0	3*
230	24 / 1040	27.00	1	060-0206.0	3*
230	2x6 / 2080	2x6.90	2	060-0207.0	3*
230	2x9 / 1390	2x10.50	2	060-0208.0	3*
230	2x12 / 1040	2x13.60	2	060-0209.0	3*
230	2x15 / 830	2x17.30	2	060-0210.0	3*
2x115	6 / 4170	6.90	3	060-0272.0	3*
2x115	9 / 2780	10.30	3	060-0273.0	3*
2x115	12 / 2080	13.60	3	060-0274.0	3*
2x115	15 / 1670	17.00	3	060-0275.0	3*
2x115	18 / 1390	20.50	3	060-0276.0	3*
2x115	24 / 1040	27.00	3	060-0277.0	3*
2x115	2x6 / 2080	2x6.90	4	060-0278.0	3*
2x115	2x9 / 1390	2x10.50	4	060-0279.0	3*
2x115	2x12 / 1040	2x13.60	4	060-0280.0	3*
2x115	2x15 / 830	2x17.30	4	060-0281.0	3*

Mechanical

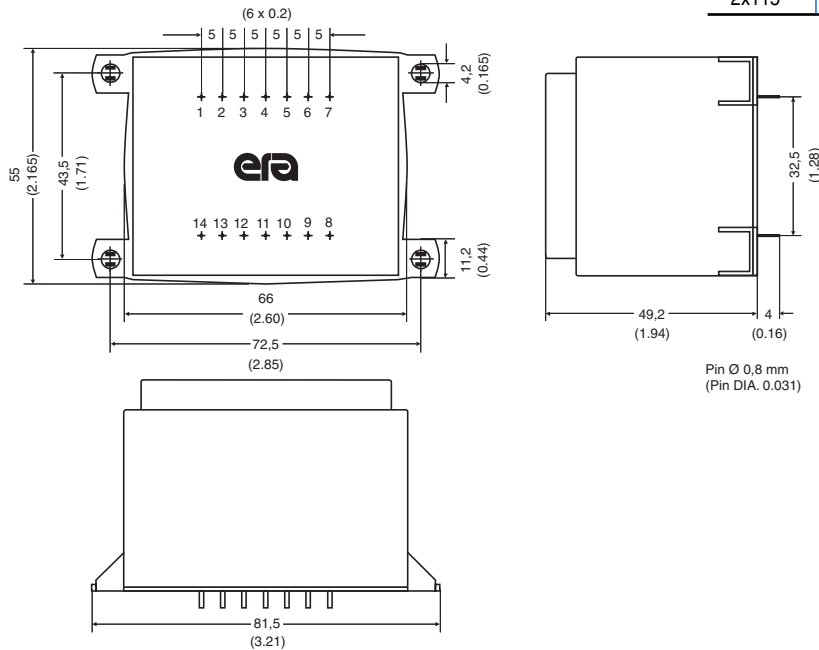

***NOTE:** When checking the approval status of this product with VDE, add the prefix "BV" to the orderable Part Number (these letters will also be found on the part label). The prefix is **not** part of the orderable Part Number.

Schematics

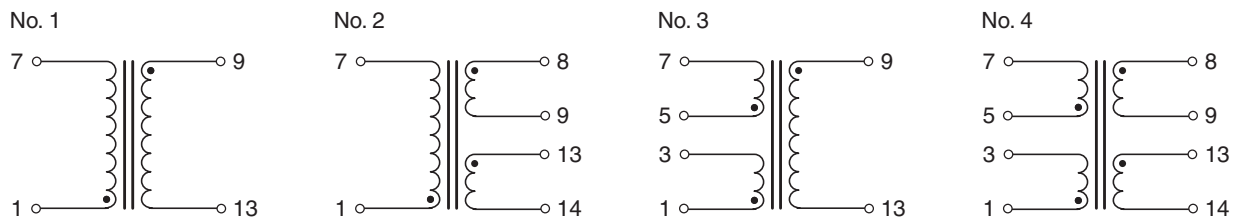

LAMINATED TRANSFORMERS

Type EI66 / 23 - 36VA



- Frequency 50/60Hz
- Potted under vacuum
- Split-bobbin
- Temperature class ta 40°C/B
- Weight: 0.75kg
- Packaging unit: 6 pieces (tray)

Primary (V)	Secondary (V / mA)	No-Load Voltage (V)	Schematic No.	Part Number	Agency Approvals
230	6 / 6000	6.90	1	066-0131.0	3*
230	9 / 4000	10.30	1	066-0132.0	3*
230	12 / 3000	13.60	1	066-0133.0	3*
230	15 / 2400	17.00	1	066-0134.0	3*
230	18 / 2000	20.50	1	066-0135.0	3*
230	24 / 1500	27.00	1	066-0136.0	3*
230	2x6 / 3000	2x6.90	2	066-0137.0	3*
230	2x9 / 2000	2x10.50	2	066-0138.0	3*
230	2x12 / 1500	2x13.60	2	066-0139.0	3*
230	2x15 / 1200	2x17.30	2	066-0140.0	3*
2x115	6 / 6000	6.90	3	066-0226.0	3*
2x115	9 / 4000	10.30	3	066-0227.0	3*
2x115	12 / 3000	13.60	3	066-0228.0	3*
2x115	15 / 2400	17.00	3	066-0229.0	3*
2x115	18 / 2000	20.50	3	066-0230.0	3*
2x115	24 / 1500	27.00	3	066-0231.0	3*
2x115	2x6 / 3000	2x6.90	4	066-0232.0	3*
2x115	2x9 / 2000	2x10.50	4	066-0233.0	3*
2x115	2x12 / 1500	2x13.60	4	066-0234.0	3*
2x115	2x15 / 1200	2x17.30	4	066-0235.0	3*

Mechanical

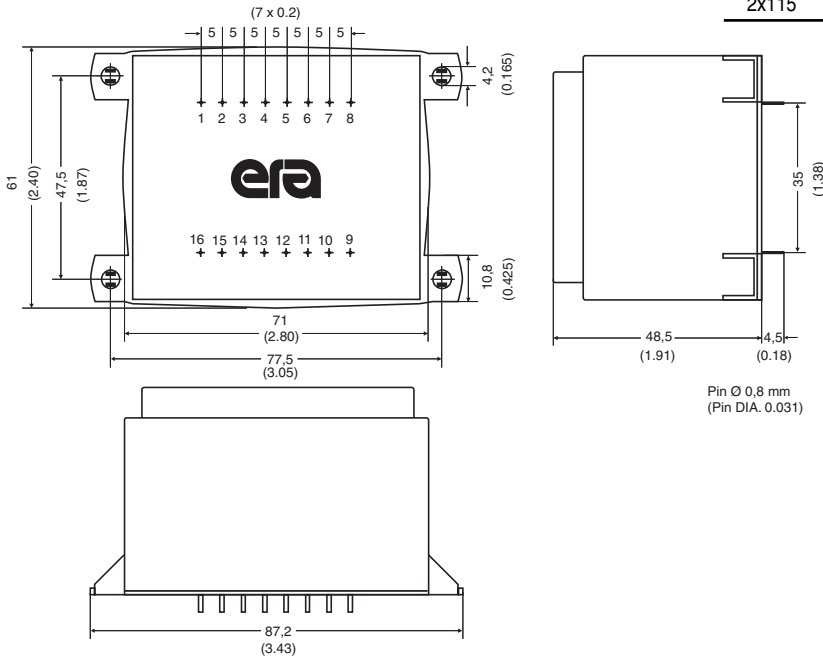

***NOTE:** When checking the approval status of this product with VDE, add the prefix "BV" and the suffix "A" to the orderable Part Number (these letters will also be found on the part label). The prefix and suffix are **not** part of the orderable Part Number.

Schematics

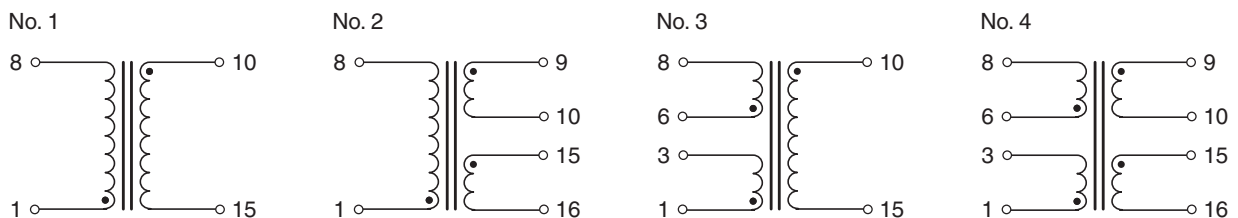

LAMINATED TRANSFORMERS

Type EI66 / 34.7 - 50VA (230V)



Primary (V)	Secondary (V / mA)	No-Load Voltage (V)	Schematic No.	Part Number	Agency Approvals
230	6 / 8333	7.20	1	066-0141.0	3*
230	9 / 5560	10.40	1	066-0142.0	3*
230	12 / 4170	13.40	1	066-0143.0	3*
230	15 / 3330	17.00	1	066-0144.0	3*
230	18 / 2780	20.50	1	066-0145.0	3*
230	24 / 2080	27.10	1	066-0146.0	3*
230	2x6 / 4170	2x7.00	2	066-0147.0	3*
230	2x9 / 2780	2x10.40	2	066-0148.0	3*
230	2x12 / 2080	2x13.60	2	066-0149.0	3*
230	2x15 / 1670	2x17.60	2	066-0150.0	3*

*NOTE: When checking the approval status of this product with VDE, add the prefix "BV" and the suffix "B" to the orderable Part Number (these letters will also be found on the part label). The prefix and suffix are not part of the orderable Part Number.

- Frequency 50/60Hz
- Potted under vacuum
- Split-bobbin
- Temperature class ta 40°C/B
- Weight: 1.04kg
- Packaging unit: 6 pieces (tray)

Mechanical

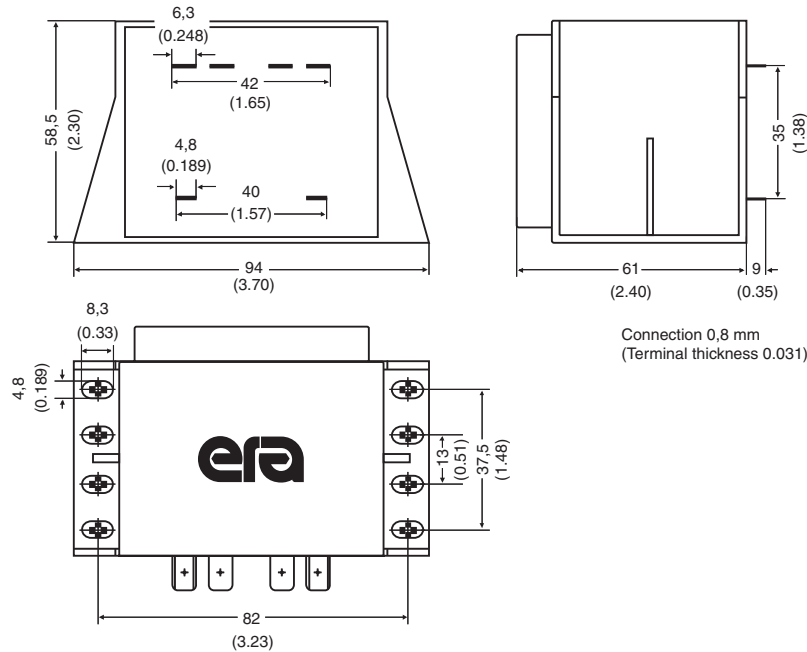

Schematics

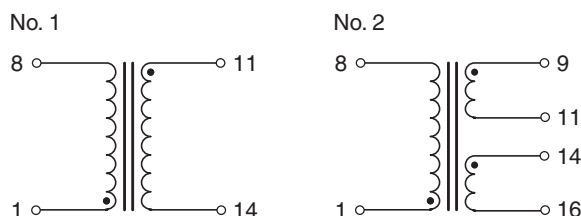

LAMINATED TRANSFORMERS

Type EI66 / 34.7 - 50VA (2x115V)



Primary (V)	Secondary (V / mA)	No-Load Voltage (V)	Schematic No.	Part Number	Agency Approvals
2x115	6 / 8333	7.20	1	066-0236.0	3*
2x115	9 / 5560	10.40	1	066-0237.0	3*
2x115	12 / 4170	13.40	1	066-0238.0	3*
2x115	15 / 3330	17.00	1	066-0239.0	3*
2x115	18 / 2780	20.50	1	066-0240.0	3*
2x115	24 / 2080	27.10	1	066-0241.0	3*
2x115	2x6 / 4170	2x7.00	2	066-0242.0	3*
2x115	2x9 / 2780	2x10.40	2	066-0243.0	3*
2x115	2x12 / 2080	2x13.60	2	066-0244.0	3*
2x115	2x15 / 1670	2x17.60	2	066-0245.0	3*

- ⊕ Frequency 50/60Hz
- ⊕ Potted under vacuum
- ⊕ Split-bobbin
- ⊕ Temperature class ta 40°C/B
- ⊕ Weight: 1.04kg
- ⊕ Packaging unit: 6 pieces (tray)

*NOTE: When checking the approval status of this product with VDE, add the prefix "BV" and the suffix "B" to the orderable Part Number (these letters will also be found on the part label). **The prefix and suffix are not part of the orderable Part Number.**

Mechanical

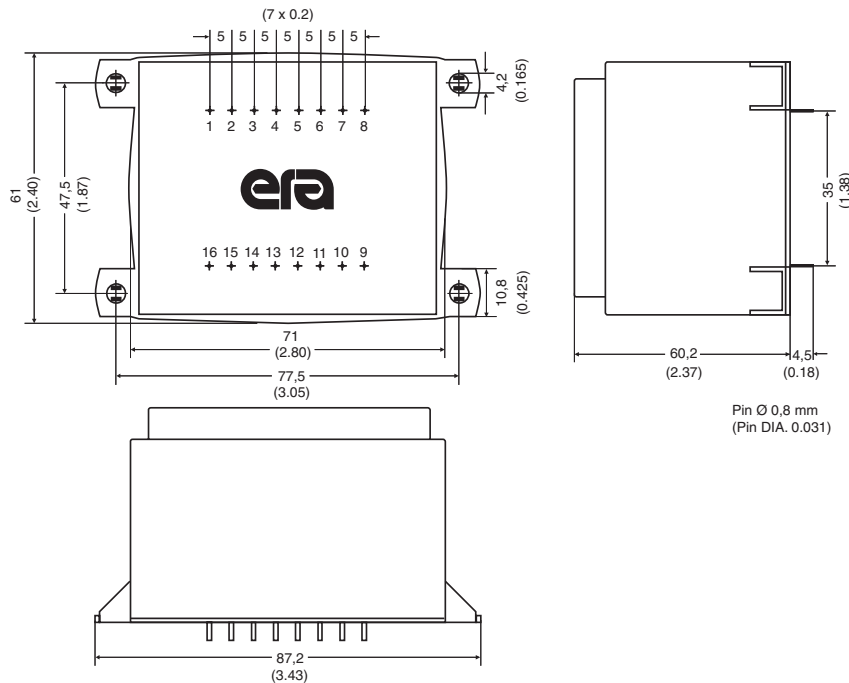

Schematics

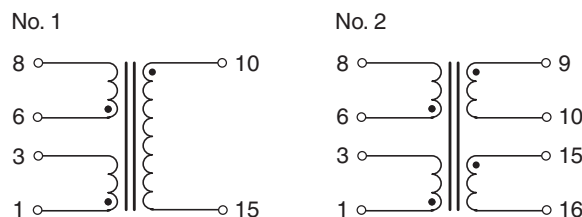

LAMINATED TRANSFORMERS

Type UI30 / 5.5 - 2VA









AGENCY APPROVALS   

1. UL 506, File E113449 

3. EN61558 

Primary (V)	Secondary (V / mA)	No-Load Voltage (V)	Part Number	Agency Approvals
2x115	6/166 / 6/166	9.10/9.10	030-6866.0	1/3*
2x115	9/111 / 9/111	13.60/13.60	030-6869.0	1/3*
2x115	12/83 / 12/83	17.60/17.60	030-6872.0	1/3*
2x115	15 / 66 / 15/66	23.00/23.00	030-6875.0	1/3*
2x115	18/55 / 18/55	24.80/24.80	030-6878.0	1/3*
2x115	21/47 / 21/47	30.50/30.50	030-6881.0	1

***NOTE:** When checking the approval status of this product with VDE, add the prefix "BV" and the suffix "L" to the orderable Part Number (these letters will also be found on the part label). **The prefix and suffix are not part of the orderable Part Number.**

-  Frequency 50/60Hz
-  Potted under vacuum
-  Split-bobbin
-  Temperature class ta 70°C/B
-  Weight: 0.115kg
-  Packaging unit: 15 pieces (tray)
-  Fixing material for □ 2,5mm (0.098 inch)
 - Self-tapping screws: DIN 7513 (M 3x8)
 - Sheet-metal screws: DIN 7971 (2,9x6,5)

Mechanical

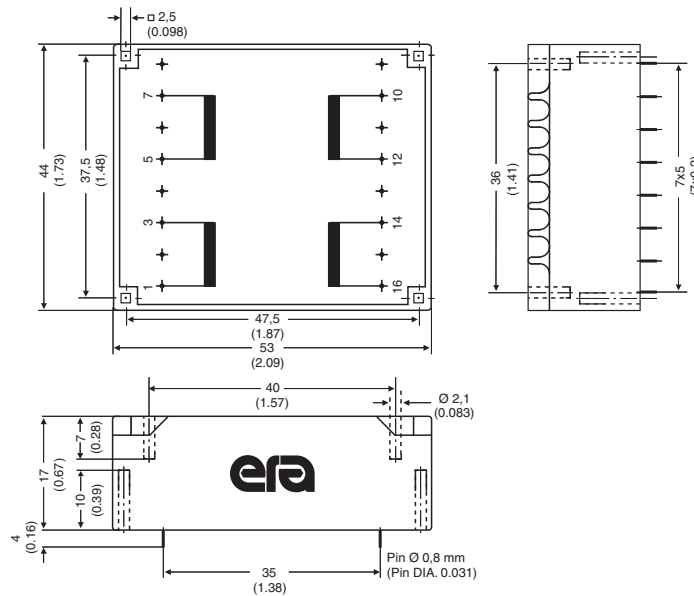

Schematics

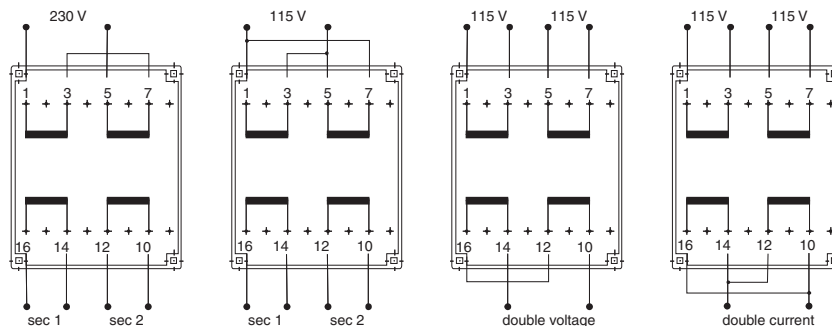

LAMINATED TRANSFORMERS

Type UI30 / 7.5 - 4VA









AGENCY APPROVALS   

1. UL 506, File E113449

3. EN61558

Primary (V)	Secondary (V / mA)	No-Load Voltage (V)	Part Number	Agency Approvals
2x115	6/333 / 6/333	8.60/8.60	030-6935.0	1/3*
2x115	9/222 / 9/222	12.40/12.40	030-6938.0	1/3*
2x115	12/166 / 12/166	15.90/15.90	030-6941.0	1/3*
2x115	15/133 / 15/133	20.80/20.80	030-6944.0	1/3*
2x115	18/111 / 18/111	24.30/24.30	030-6947.0	1/3*
2x115	21/95 / 21/95	28.10/28.10	030-6950.0	1

***NOTE:** When checking the approval status of this product with VDE, add the prefix "BV" and the suffix "L" to the orderable Part Number (these letters will also be found on the part label). The prefix and suffix are not part of the orderable Part Number.

-  Frequency 50/60Hz
-  Potted under vacuum
-  Split-bobbin
-  Temperature class ta 70°C/B
-  Weight: 0.145kg
-  Packaging unit: 15 pieces (tray)
-  Fixing material for □ 2,5mm (0.098 inch)
 - Self-tapping screws: DIN 7513 (M 3x8)
 - Sheet-metal screws: DIN 7971 (2,9x6,5)

Mechanical

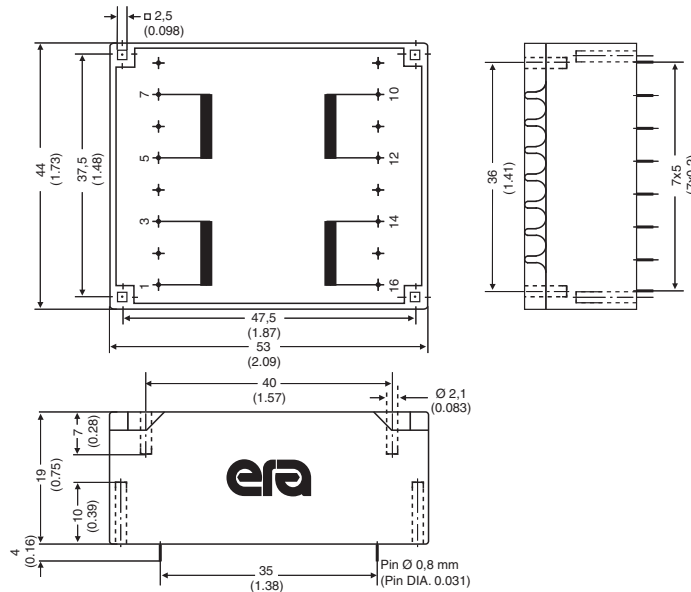

Schematics

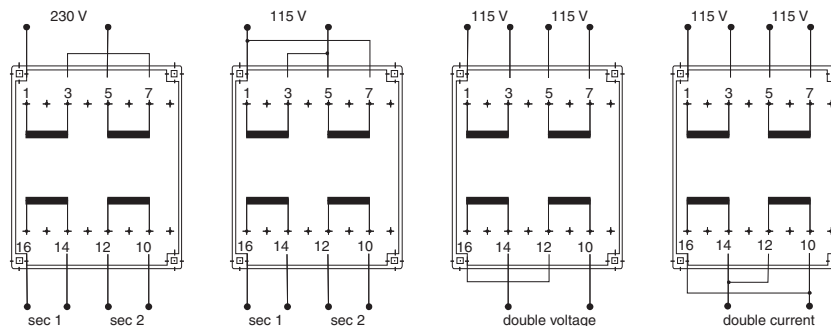

LAMINATED TRANSFORMERS

Type UI30 / 10.5 - 6VA









AGENCY APPROVALS 

1. UL 506, File E113449 

3. EN61558  

Primary (V)	Secondary (V / mA)	No-Load Voltage (V)	Part Number	Agency Approvals
2x115	6/500 / 6/500	8.50/8.50	030-7004.0	1/3*
2x115	9/333 / 9/333	12.70/12.70	030-7007.0	1/3*
2x115	12/250 / 12/250	16.30/16.30	030-7010.0	1/3*
2x115	15/200 / 15/200	20.30/20.30	030-7013.0	1/3*
2x115	18/166 / 18/166	24.30/24.30	030-7016.0	1/3*
2x115	21/142 / 21/142	28.30/28.30	030-7019.0	1

***NOTE:** When checking the approval status of this product with VDE, add the prefix "BV" and the suffix "L" to the orderable Part Number (these letters will also be found on the part label). The prefix and suffix are not part of the orderable Part Number.

-  Frequency 50/60Hz
-  Potted under vacuum
-  Split-bobbin
-  Temperature class ta 40°C/B
-  Weight: 0.175kg
-  Packaging unit: 15 pieces (tray)
-  Fixing material for \square 2,5mm (0.098 inch)
 - Self-tapping screws: DIN 7513 (M 3x8)
 - Sheet-metal screws: DIN 7971 (2,9x6,5)

Mechanical

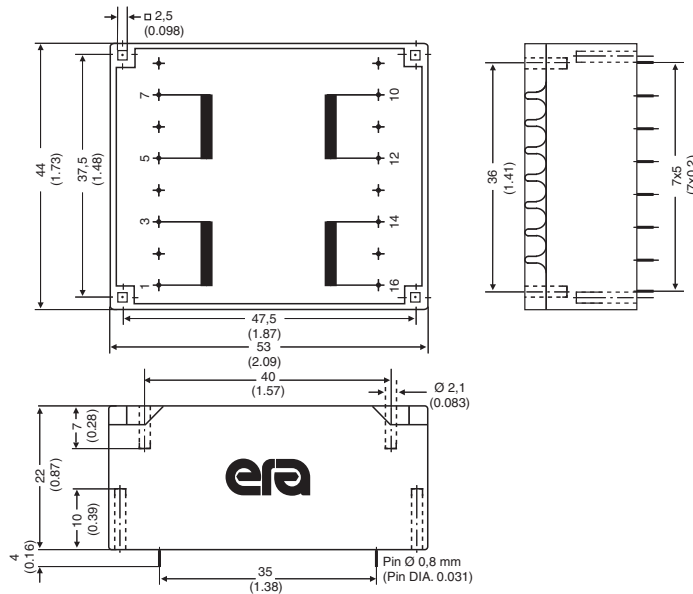

Schematics

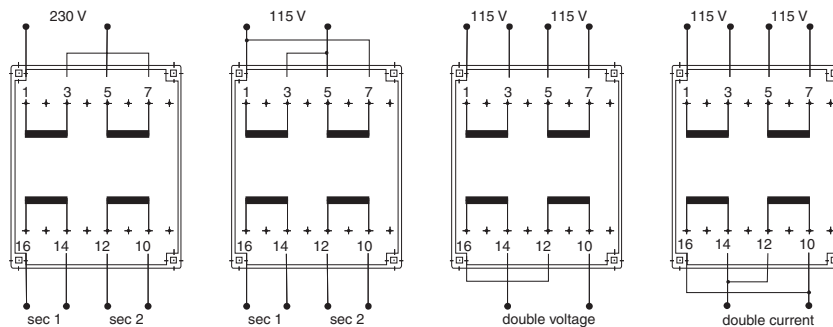

USA 858 674 8100 • Germany 49 7032 7806 0 • Singapore 65 6287 8998 • Shanghai 86 21 54643211 / 2 • China 86 769 85538070 • Taiwan 886 3 4641811

LAMINATED TRANSFORMERS

Type UI30 / 16.5 - 10VA









AGENCY APPROVALS   

1. UL 506, File E113449 

3. EN61558 

Primary (V)	Secondary (V / mA)	No-Load Voltage (V)	Part Number	Agency Approvals
2x115	6/833 / 6/833	9.00/9.00	030-7073.0	1/3*
2x115	9/555 / 9/555	13.40/13.40	030-7076.0	1/3*
2x115	12/416 / 12/416	17.20/17.20	030-7079.0	1/3*
2x115	15/333 / 15/333	21.70/21.70	030-7082.0	1/3*
2x115	18/277 / 18/277	24.80/24.80	030-7085.0	1/3*
2x115	21/238 / 21/238	29.50/29.50	030-7088.0	1

*NOTE: When checking the approval status of this product with VDE, add the prefix "BV" and the suffix "L" to the orderable Part Number (these letters will also be found on the part label). The prefix and suffix are not part of the orderable Part Number.

-  Frequency 50/60Hz
-  Potted under vacuum
-  Split-bobbin
-  Temperature class ta 40°C/B
-  Weight: 0.24kg
-  Packaging unit: 15 pieces (tray)
-  Fixing material for □ 2,5mm (0.098 inch)
 - Self-tapping screws: DIN 7513 (M 3x8)
 - Sheet-metal screws: DIN 7971 (2,9x6,5)

Mechanical

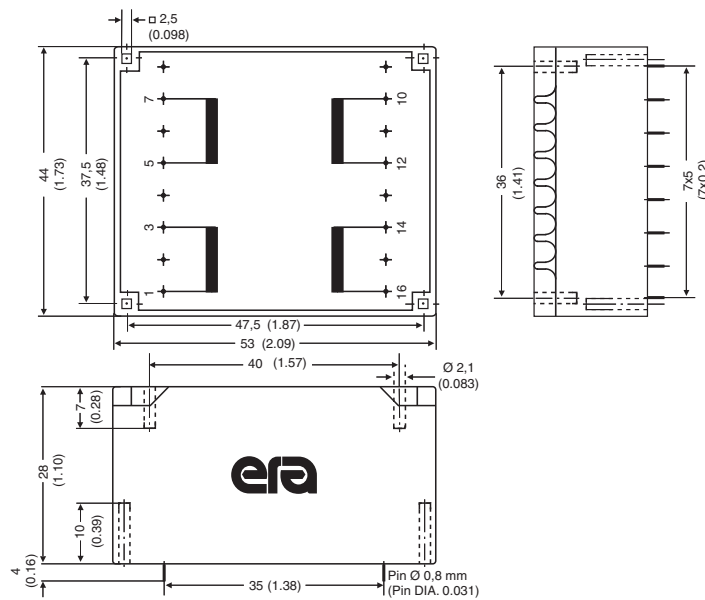

Schematics

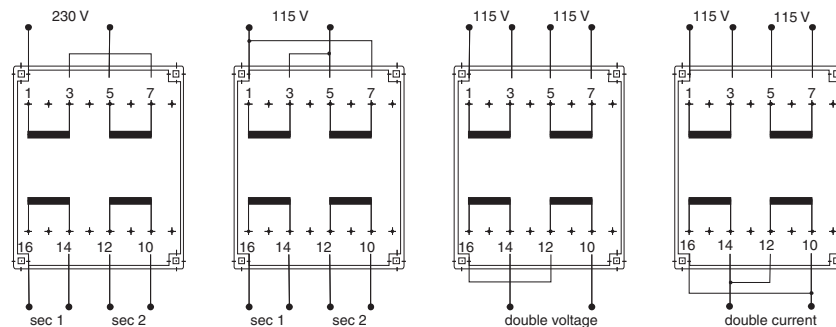



LAMINATED TRANSFORMERS

Type UI39 / 8 - 10VA









AGENCY APPROVALS 

1. UL 506, File E113449 

3. EN61558  

Primary (V)	Secondary (V / mA)	No-Load Voltage (V)	Part Number	Agency Approvals
2x115	6/833 / 6/833	8.50/8.50	039-5026.0	1/3*
2x115	9/555 / 9/555	12.40/12.40	039-5029.0	1/3*
2x115	12/416 / 12/416	15.90/15.90	039-5032.0	1/3*
2x115	15/333 / 15/333	20.30/20.30	039-5035.0	1/3*
2x115	18/277 / 18/277	24.30/24.30	039-5038.0	1/3*
2x115	21/238 / 21/238	28.10/28.10	039-5041.0	1

***NOTE:** When checking the approval status of this product with VDE, add the prefix "BV" and the suffix "L" to the orderable Part Number (these letters will also be found on the part label). **The prefix and suffix are not part of the orderable Part Number.**

-  Frequency 50/60Hz
-  Potted under vacuum
-  Split-bobbin
-  Temperature class ta 40°C/B
-  Weight: 0.28kg
-  Packaging unit: 10 pieces (tray)
-  Fixing material for \square 2,5mm (0.098 inch)
 - Self-tapping screws: DIN 7513 (M 3x8)
 - Sheet-metal screws: DIN 7971 (2,9x6,5)

Mechanical

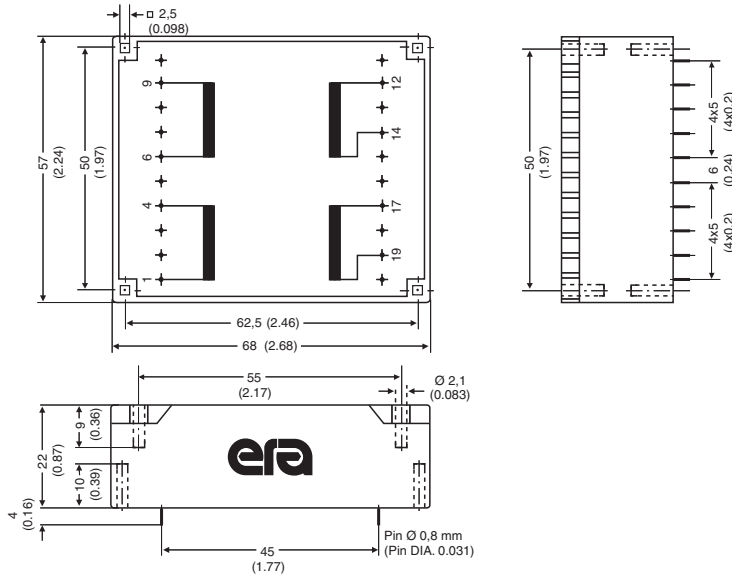

Schematics

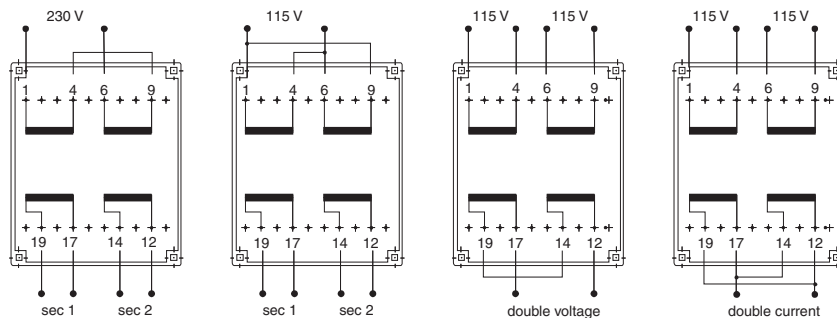

LAMINATED TRANSFORMERS

Type UI39 / 10.2 - 14VA









AGENCY APPROVALS    

1. UL 506, File E113449

3. EN61558

Primary (V)	Secondary (V / mA)	No-Load Voltage (V)	Part Number	Agency Approvals
2x115	6/1166 / 6/1166	7.80/7.80	039-5095.0	1/3*
2x115	9/777 / 9/777	11.20/11.20	039-5098.0	1/3*
2x115	12/583 / 12/583	14.80/14.80	039-5101.0	1/3*
2x115	15/466 / 15/466	18.80/18.80	039-5104.0	1/3*
2x115	18/388 / 18/388	22.70/22.70	039-5107.0	1/3*
2x115	21/333 / 21/333	24.80/24.80	039-5110.0	1/3*

*NOTE: When checking the approval status of this product with VDE, add the prefix "BV" and the suffix "L" to the orderable Part Number (these letters will also be found on the part label). The prefix and suffix are not part of the orderable Part Number.

-  Potted under vacuum
-  Split-bobbin
-  Temperature class ta 40°C/B
-  Weight: 0.315kg
-  Packaging unit: 10 pieces (tray)
-  Fixing material for □ 2,5mm (0.098 inch)
 - Self-tapping screws: DIN 7513 (M 3x8)
 - Sheet-metal screws: DIN 7971 (2,9x6,5)

Mechanical

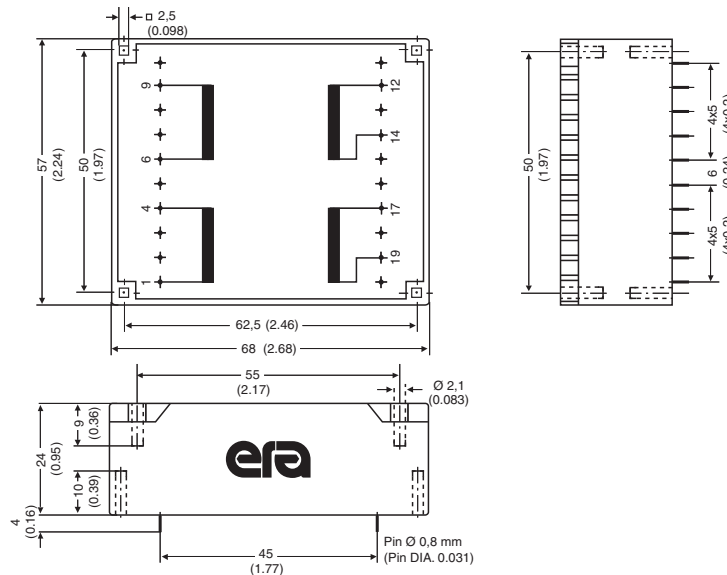

Schematics

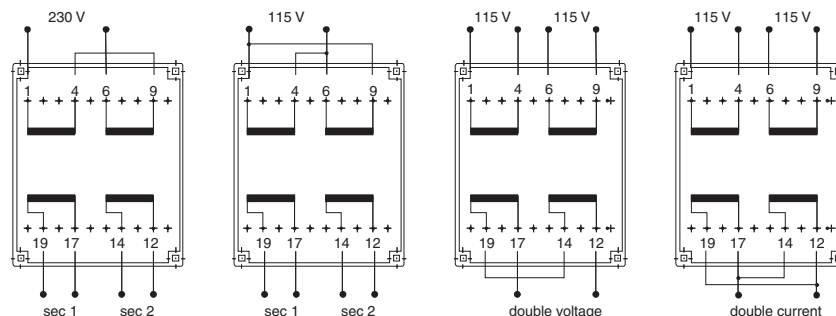

USA 858 674 8100 • Germany 49 7032 7806 0 • Singapore 65 6287 8998 • Shanghai 86 21 54643211 / 2 • China 86 769 85538070 • Taiwan 886 3 4641811

LAMINATED TRANSFORMERS

Type UI39 / 13.5 - 18VA



AGENCY APPROVALS 

1. UL 506, File E113449 

3. EN61558  

Primary (V)	Secondary (V / mA)	No-Load Voltage (V)	Part Number	Agency Approvals
2x115	6/1500 / 6/1500	8.40/8.40	039-5164.0	1/3*
2x115	9/1000 / 9/1000	11.60/11.60	039-5167.0	1/3*
2x115	12/750 / 12/750	15.30/15.30	039-5170.0	1/3*
2x115	15/600 / 15/600	19.40/19.40	039-5173.0	1/3*
2x115	18/500 / 18/500	22.50/22.50	039-5176.0	1/3*
2x115	21/428 / 21/428	24.60/24.60	039-5179.0	1/3*

***NOTE:** When checking the approval status of this product with VDE, add the prefix "BV" and the suffix "L" to the orderable Part Number (these letters will also be found on the part label). **The prefix and suffix are not part of the orderable Part Number.**

- 🔩 Frequency 50/60Hz
- 🔩 Weight: 0.375kg
- 🔩 Potted under vacuum
- 🔩 Packaging unit: 10 pieces (tray)
- 🔩 Split-bobbin
- 🔩 Fixing material for □ 2,5mm (0.098 inch)
- 🔩 Temperature class ta 40°C/B
- Self-tapping screws: DIN 7513 (M 3x8)
- Sheet-metal screws: DIN 7971 (2,9x6,5)

Mechanical

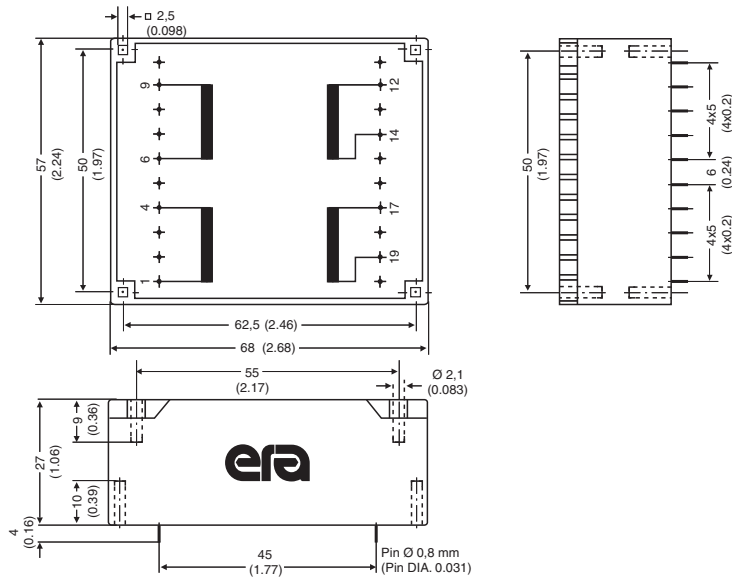

Schematics

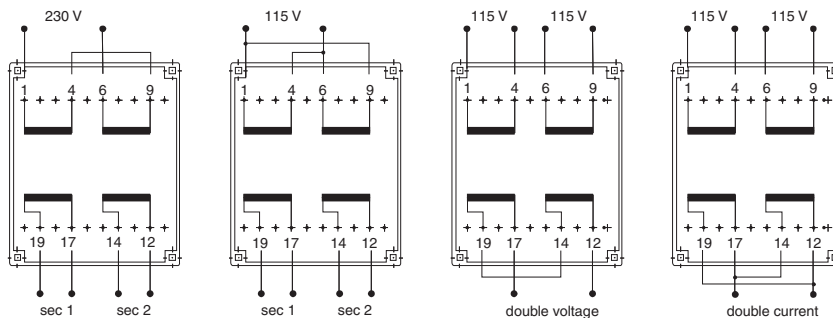

USA 858 674 8100 • Germany 49 7032 7806 0 • Singapore 65 6287 8998 • Shanghai 86 21 54643211 / 2 • China 86 769 85538070 • Taiwan 886 3 4641811

LAMINATED TRANSFORMERS

Type UI39 / 17 - 24VA



AGENCY APPROVALS   

1. UL 506, File E113449 

3. EN61558 

Primary (V)	Secondary (V / mA)	No-Load Voltage (V)	Part Number	Agency Approvals
2x115	6/2000 / 6/2000	8.10/8.10	039-5233.0	1/3*
2x115	9/1333 / 9/1333	11.10/11.10	039-5236.0	1/3*
2x115	12/1000 / 12/1000	14.40/14.40	039-5239.0	1/3*
2x115	15/800 / 15/800	19.20/19.20	039-5242.0	1/3*
2x115	18/666 / 18/666	22.10/22.10	039-5245.0	1/3*
2x115	21/571 / 21/571	24.70/24.70	039-5248.0	1/3*

*NOTE: When checking the approval status of this product with VDE, add the prefix "BV" and the suffix "L" to the orderable Part Number (these letters will also be found on the part label). The prefix and suffix are not part of the orderable Part Number.

- Frequency 50/60Hz
- Weight: 0.445kg
- Potted under vacuum
- Packaging unit: 10 pieces (tray)
- Split-bobbin
- Fixing material for □ 2,5mm (0.098 inch)
- Temperature class ta 40°C/B
- Self-tapping screws: DIN 7513 (M 3x8)
- Sheet-metal screws: DIN 7971 (2,9x6,5)

Mechanical

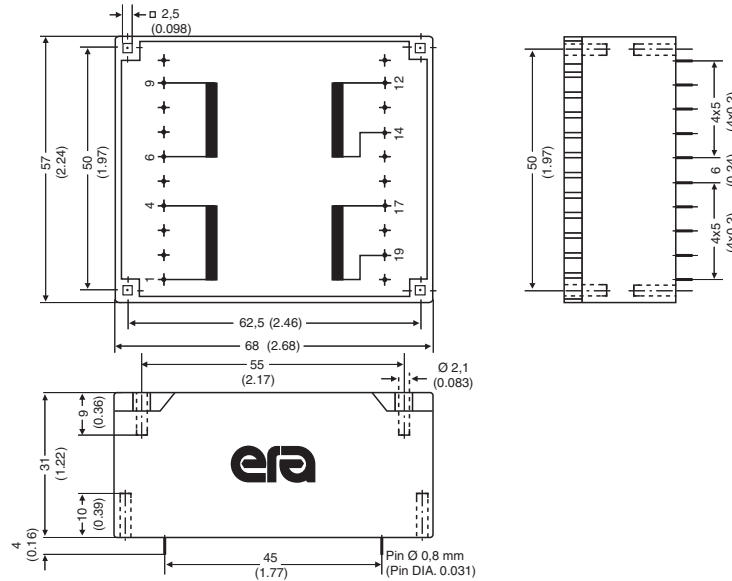

Schematics

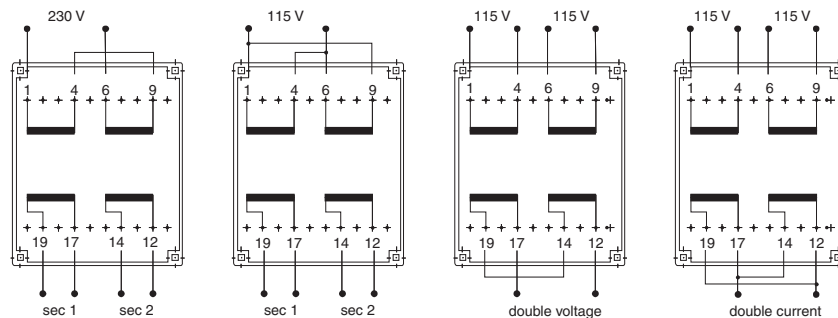



USA 858 674 8100 • Germany 49 7032 7806 0 • Singapore 65 6287 8998 • Shanghai 86 21 54643211 / 2 • China 86 769 85538070 • Taiwan 886 3 4641811

LAMINATED TRANSFORMERS

Type UI39 / 21 - 30VA



AGENCY APPROVALS 

1. UL 506, File E113449 

3. EN61558  

Primary (V)	Secondary (V / mA)	No-Load Voltage (V)	Part Number	Agency Approvals
2x115	6/2500 / 6/2500	6.70/6.70	039-5302.0	1/3*
2x115	9/1666 / 9/1666	10.30/10.30	039-5305.0	1/3*
2x115	12/1250 / 12/1250	13.80/13.80	039-5308.0	1/3*
2x115	15/1000 / 15/1000	17.20/17.20	039-5311.0	1/3*
2x115	18/833 / 18/833	20.60/20.60	039-5314.0	1/3*
2x115	21/714 / 21/714	23.50/23.50	039-5317.0	1/3*

*NOTE: When checking the approval status of this product with VDE, add the prefix "BV" and the suffix "L" to the orderable Part Number (these letters will also be found on the part label). The prefix and suffix are not part of the orderable Part Number.

- Frequency 50/60Hz
- Weight: 0.53kg
- Potted under vacuum
- Packaging unit: 10 pieces (tray)
- Split-bobbin
- Fixing material for □ 2,5mm (0.098 inch)
- Temperature class ta 40°C/B
- Self-tapping screws: DIN 7513 (M 3x8)
- Sheet-metal screws: DIN 7971 (2,9x6,5)

Mechanical

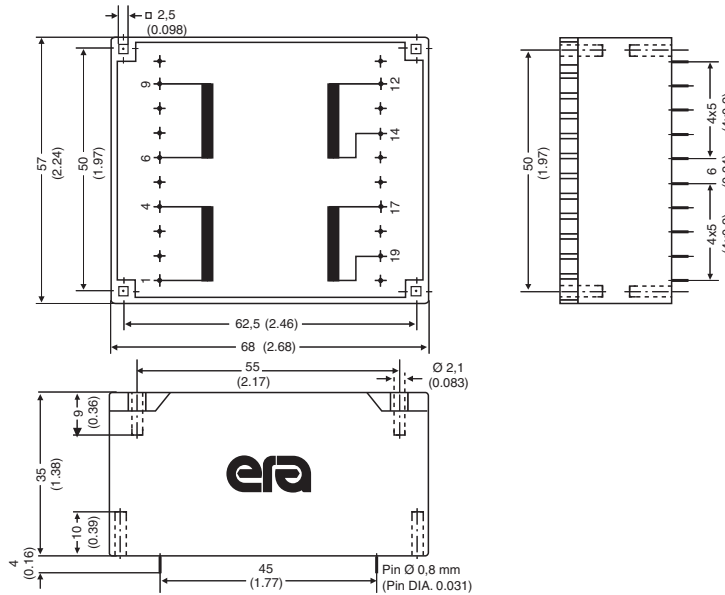

Schematics

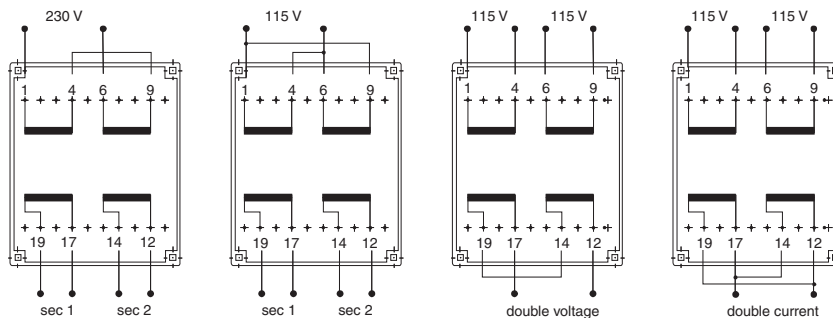

USA 858 674 8100 • Germany 49 7032 7806 0 • Singapore 65 6287 8998 • Shanghai 86 21 54643211 / 2 • China 86 769 85538070 • Taiwan 886 3 4641811

LAMINATED TRANSFORMERS

Type EI48 / 16.8 (AC)



- ⊕ Potted under vacuum
- ⊕ Split-bobbin
- ⊕ Temperature class ta 40°C/B
- ⊕ Non-inherently short circuit proof with integrated thermal fuse
- ⊕ Connection via lead wire with ferrule
- ⊕ Wire length: 150mm
- ⊕ Weight: 0.3kg
- ⊕ Packaging unit: 8 pieces (tray)

Part Number	Primary (V)	Secondary (V _{AC} / mA)	No-Load Voltage (V)
048-0738.4	230	8/1250	10.50

Type EI48 / 16.8 (DC)



- ⊕ Potted under vacuum
- ⊕ Split-bobbin
- ⊕ Temperature class ta 40°C/B
- ⊕ Integrated rectifier
- ⊕ Non-inherently short circuit proof with integrated thermal fuse
- ⊕ Connection via lead wire with ferrule
- ⊕ Wire length: 150mm
- ⊕ Weight: 0.3kg
- ⊕ Packaging unit: 8 pieces (tray)

Part Number	Primary (V)	Secondary (V _{DC} / mA)	No-Load Voltage (V)
048-0739.4	230	12/700	27.50
048-0740.4	230	24/350	46.00

LAMINATED TRANSFORMERS

Type EI66 / 23



- ⊕ Potted under vacuum
- ⊕ Split-bobbin
- ⊕ Temperature class ta 40°C/B
- ⊕ Integrated rectifier
- ⊕ Non-inherently short circuit proof with integrated thermal fuse
- ⊕ Connection via lead wire with ferrule
- ⊕ Wire length: 150mm
- ⊕ DIN-rail mounting
- ⊕ Weight: 1.0kg
- ⊕ Packaging unit: 4 pieces (tray)

Part Number	Primary (V)	Secondary (Vdc / mA)	No-Load Voltage (V)
066-0329.4	230	12/2000	18.00
066-0330.4	230	24/1000	36.50

Type EI84 / 29.5







- ⊕ Potted under vacuum
- ⊕ Split-bobbin
- ⊕ Temperature class ta 40°C/B
- ⊕ Integrated rectifier
- ⊕ Connection via lead wire with ferrule
- ⊕ Wire length: 150mm
- ⊕ DIN-rail mounting
- ⊕ Weight: 1.94kg
- ⊕ Packaging unit: 4 pieces (tray)

Part Number	Primary (V)	Secondary (Vdc / mA)	No-Load Voltage (V)
084-0082.0	230	12/5000	18.00
084-0083.0	230	24/2500	35.50

IGNITION TRANSFORMERS

Spark-Line - 233mH - 375mH



-  Compact Design
-  Available up to 23kV
-  Ambient Temperature 70°C
-  Weight: 0.018kg
-  Packaging unit: 55 pieces (tray)

Part Number	Primary Resistance (±10%) (Pin 1-2)	Secondary Resistance (±10%) (Pin 3-4)	Primary Inductance (±15%) (Pin 1-2)	Secondary Inductance (±15%) (Pin 3-4)	Winding Ratio	Secondary Voltage @ load 30pF	Ambient Temperature	No-Load Operation (MAX)
125-0028.0	26mΩ	520Ω	6μH	240mH	1:200	>22kV	70°C	30s
125-0031.0	26mΩ	786Ω	6μH	375mH	1:256	>20kV	70°C	30s
125-0033.0	59mΩ	822Ω	12μH	340mH	1:175	>23kV	70°C	30s
125-0039.0	59mΩ	590Ω	12μH	233mH	1:150	>23kV	70°C	30s

Mechanical

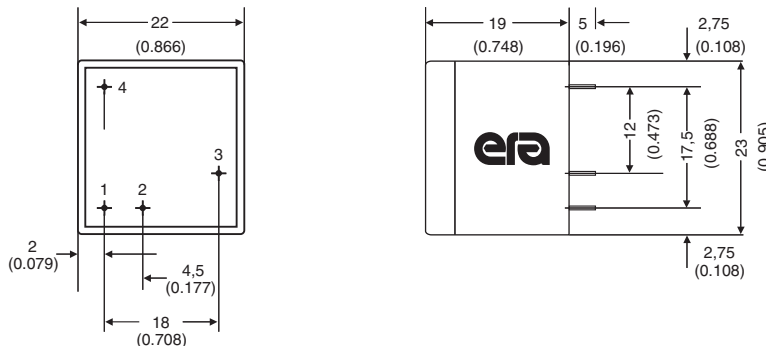



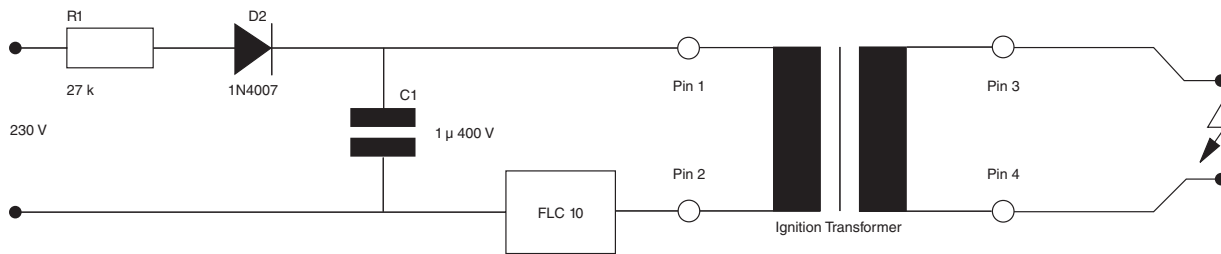

Schematic



IGNITION TRANSFORMERS

Spark-Line - Secondary External (1x)



-  Compact Design
-  Available up to 22kV
-  Ambient Temperature 70°C
-  Weight: 0.019kg
-  Packaging unit: 45 pieces (tray)

Part Number	Primary Resistance (±10%) (Pin 1-2)	Secondary Resistance (±10%) (Pin 3-6)	Primary Inductance (±15%) (Pin 1-2)	Secondary Inductance (±15%) (Pin 3-6)	Winding Ratio	Secondary Voltage @ load 30pF	Ambient Temperature	No-Load Operation (MAX)
125-0032.0	26mΩ	520Ω	6μH	240mH	1:200	>22kV	70°C	30s

Mechanical

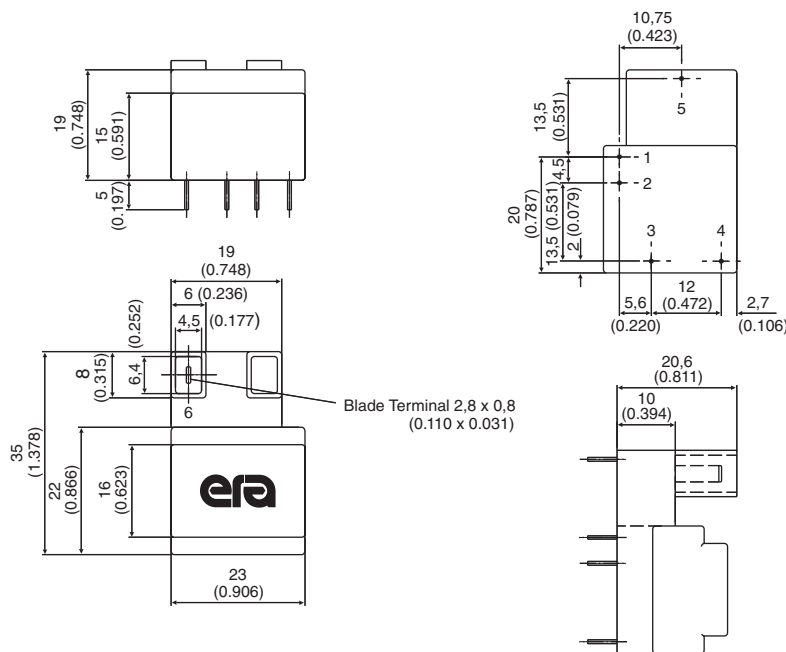

Schematic

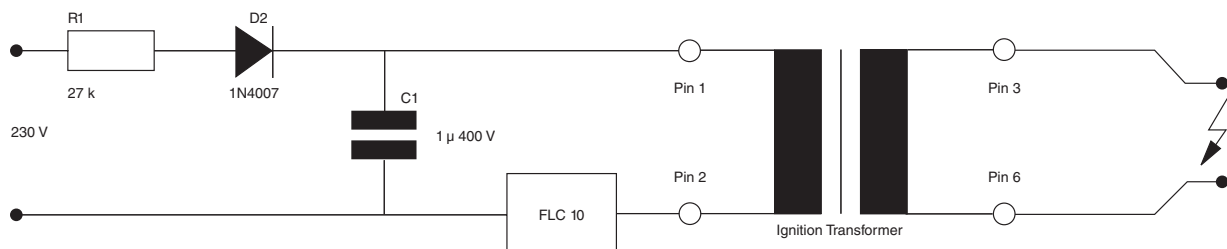

IGNITION TRANSFORMERS

Spark-Line - Secondary External (2x)



- Compact Design
- Available up to 23kV
- Ambient Temperature 70°C
- Weight: 0.018kg
- Packaging unit: 45 pieces (tray)

Part Number	Primary Resistance (±10%) (Pin 1-2)	Secondary Resistance (±10%) (Pin 6-7)	Primary Inductance (±15%) (Pin 1-2)	Secondary Inductance (±15%) (Pin 6-7)	Winding Ratio	Secondary Voltage @ load 30pF	Ambient Temperature	No-Load Operation (MAX)
125-0035.0	26mΩ	520Ω	6μH	240mH	1:200	>22kV	70°C	30s
125-0049.0	59mΩ	822Ω	12μH	340mH	1:175	>23kV	70°C	30s

Mechanical

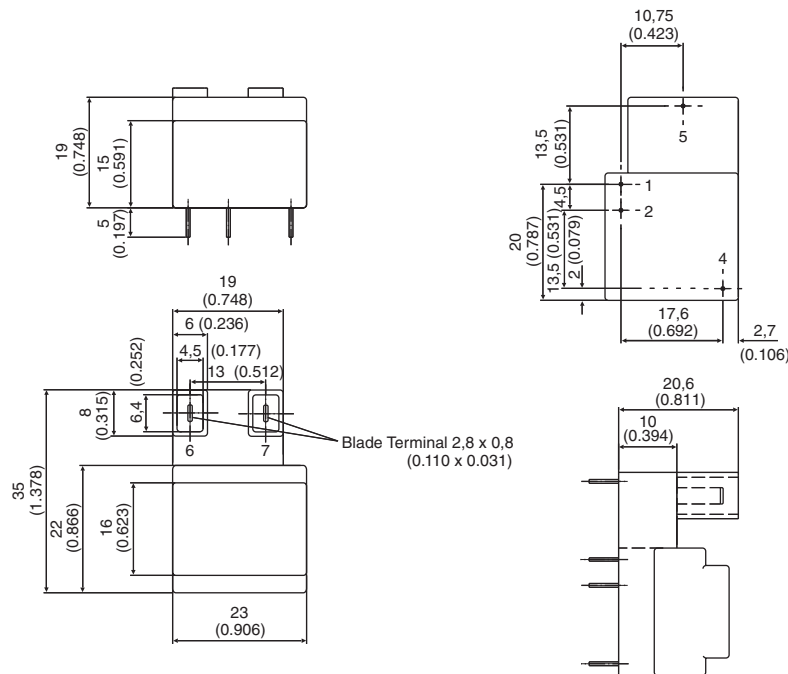

Schematic

