

Description

- Fast acting, low breaking capacity
- Optional Axial leads available
- 5mm x 20mm physical size
- Glass tube, nickel-plated brass endcap construction
- Designed to IEC 60127-2 (32mA-6.3A)



ELECTRICAL CHARACTERISTICS									
In	1.5 In		2.1 In		2.75 In		4 In		10 In
	min	max	min	max	min	max	min	max	max
32mA-100mA	60 min	30 min	10 ms	500 ms	3 ms	100 ms	20 ms		20 ms
125mA-6.3A	60 min	30 min	50 ms	2 sec	10 ms	300 ms	20 ms		20 ms

Agency Information

- UL Recognized Card: (32mA-10A) Guide JDYX2, File E19180
- CSA Component Acceptance: File 53787
- cURus Recognition: Guide JDYX8, File E19180
- SEMKO Approval 160mA-10A
- VDE Approval 160mA-10A
- BSI Approval 160mA-10A
- IMQ Approval 160mA-10A
- CCC Approval 160mA-6.3A

Ordering

- Specify packaging, product, and option code
- For -R option, drop mA or A from product code (i.e. S500-2-R)

Dimensions

Drawing Not to Scale

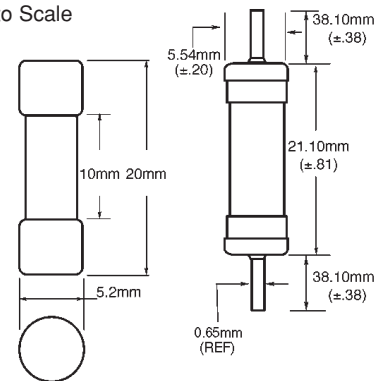

- Ratings above 6.3A have a 0.8mm diameter lead
- With TR2 packaging code, lead wire length is 19.05mm

SPECIFICATIONS

Product Code	Voltage Rating AC	Interrupting Rating at Rated Voltage (50Hz) AC	Typical DC Cold Resistance (ohms)*	Typical Melting I ² t (A ² Sec) AC†	Maximum Voltage Drop (mV)‡
S500-32mA	250V	35A	41.5	0.000047	3200
S500-40mA	250V	35A	25.5	0.00011	2500
S500-50mA	250V	35A	17.5	0.00020	2400
S500-63mA	250V	35A	12.9	0.00057	2000
S500-80mA	250V	35A	5.2	0.0012	1200
S500-100mA	250V	35A	3.9	0.003	1100
S500-125mA	250V	35A	2.9	0.005	1000
S500-160mA	250V	35A	9.2	0.008	2000
S500-200mA	250V	35A	7.0	0.016	1700
S500-250mA	250V	35A	4.5	0.28	1400
S500-315mA	250V	35A	3.2	0.58	1300
S500-400mA	250V	35A	1.9	0.18	1100
S500-500mA	250V	35A	0.27	0.18	220
S500-630mA	250V	35A	0.21	0.35	220
S500-800mA	250V	35A	0.15	0.67	190
S500-1A	250V	35A	0.13	0.60	200
S500-1.25A	250V	35A	0.098	0.84	200
S500-1.6A	250V	35A	0.068	1.6	190
S500-2A	250V	35A	0.044	4.2	150
S500-2.5A	250V	35A	0.035	6.1	150
S500-3.15A	250V	35A	0.026	13	130
S500-4A	250V	40A	0.022	22	130
S500-5A	250V	50A	0.015	42	120
S500-6.3A	250V	63A	0.010	69	120
S500-8A	250V	80A	N/A	N/A	N/A
S500-10A	250V	100A	N/A	N/A	N/A

* DC Cold Resistance (Measured at <10% of rated current)

† Typical Melting I²t (I²t was measured at listed interrupting rating and rated voltage)

‡ Maximum Voltage Drop (Voltage drop was measured at 20°C ambient temperature at rated current)

TIME CURRENT CURVE
Time-Current Characteristic Curves—Average Melt

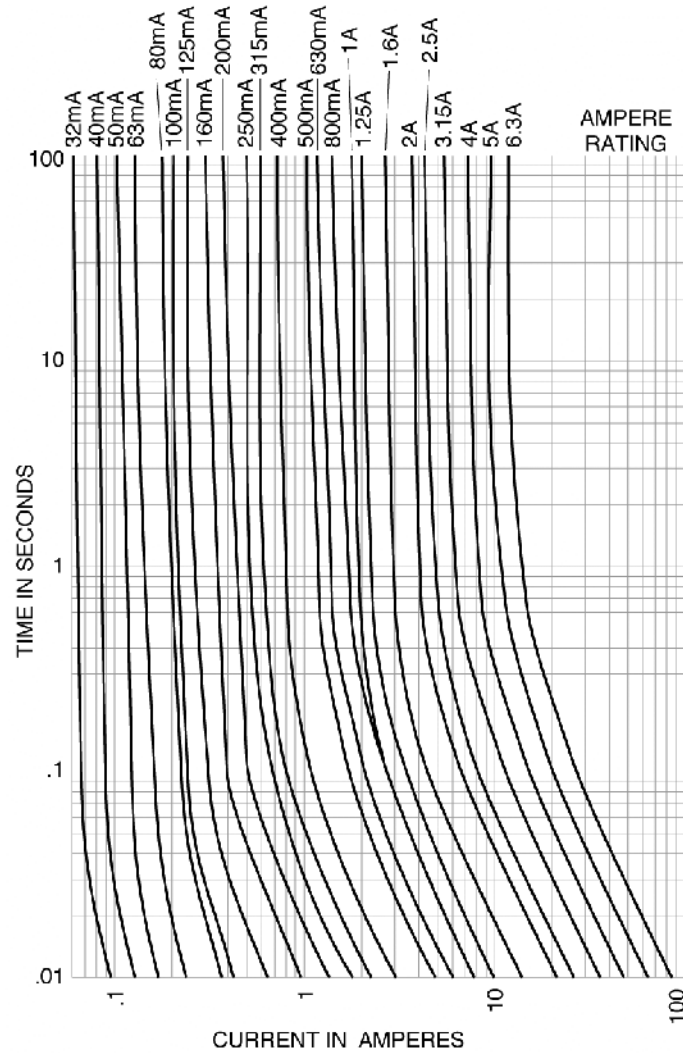

PACKAGING CODE	
Packaging Code	Description
BK	100 pieces of fuses packed into a cardboard carton
BK1	1,000 pieces of fuses packed into a poly bag
TR2	1,500 pieces of fuses packed into tape on a reel (19.05mm lead wire length)

OPTION CODE	
Option Code	Description
V	Axial leads - copper tinned wire with nickel plated brass overcaps
-R	RoHS compliant version