

Safety Relay Unit

G9SA

CSM_G9SA_DS_E_4_1

The G9SA Series Offers a Complete Line-up of Compact Units.



- Four kinds of 45-mm wide Units are available:
A 3-pole model, a 5-pole model, and models with 3 poles and 2 OFF-delay poles, as well as a Two-hand Controller. Also available are 17.5-mm wide Expansion Units with 3 poles and 3 OFF-delay poles.
- Simple expansion connection.
- OFF-delay models have 15-step OFF-delay settings.
- Conforms to EN standards. (BG approval)
- Both DIN track mounting and screw mounting are possible.



 Be sure to read the "Safety Precautions" on page 14

Model Number Structure

Model Number Legend

Note: Please see "Ordering Information" on page 2 for the actual models that can be ordered.

G9SA--
1 2 3 4 5 6

1. Function

None: Emergency stop
EX: Expansion Unit
TH: Two-hand Controller

2. Contact Configuration (Safety Output)

0: None
3: 3PST-NO
5: 5PST-NO

3. Contact Configuration (OFF-delay Output)

0: None
2: DPST-NO
3: 3PST-NO

4. Contact Configuration (Auxiliary Output)

0: None
1: SPST-NC

5. Input Configuration

None: 1-channel or 2-channel input possible

6. OFF-delay Time (Max. setting time)

None: No OFF-delay
T075: 7.5 seconds
T15: 15 seconds
T30: 30 seconds

Ordering Information

Emergency-stop Units

Main contacts	Auxiliary contact	Number of input channels	Rated voltage	Model
3PST-NO	SPST-NC	1 channel or 2 channels possible	24 VAC/VDC	G9SA-301
5PST-NO			100 to 240 VAC	
			24 VAC/VDC	G9SA-501
100 to 240 VAC				

Emergency-stop OFF-delay Units

Main contacts	OFF-delay contacts	Auxiliary contact	Number of input channels	OFF-delay time	Rated voltage	Model
3PST-NO	DPST-NO	SPST-NC	1 channel or 2 channels possible	7.5 s	24 VAC/VDC	G9SA-321-T075
					100 to 240 VAC	
				15 s	24 VAC/VDC	G9SA-321-T15
					100 to 240 VAC	
				30 s	24 VAC/VDC	G9SA-321-T30
					100 to 240 VAC	

Note: Set to maximum values in the factory.

* The following 15-step OFF-delay time settings are available:

T075: 0.5, 1, 1.5, 2, 2.5, 3, 3.5, 4, 4.5, 5, 5.5, 6, 6.5, 7, and 7.5 s

T15: 1, 2, 3, 4, 5, 6, 7, 8, 9, 10, 11, 12, 13, 14, and 15 s

T30: 2, 4, 6, 8, 10, 12, 14, 16, 18, 20, 22, 24, 26, 28, and 30 s

Two-hand Controller

Main contacts	Auxiliary contact	Number of input channels	Rated voltage	Model
3PST-NO	SPST-NC	2 channels	24 VAC/VDC	G9SA-TH301
			100 to 240 VAC	

Expansion Unit

The Expansion Unit connects to a G9SA-301, G9SA-501, G9SA-321, or G9SA-TH301.

Main contacts	Auxiliary contact	Model
3PST-NO	SPST-NC	G9SA-EX301

Expansion Units with OFF-delay Outputs

The Expansion Unit connects to a G9SA-301, G9SA-501, G9SA-321, or G9SA-TH301.

Main contact form	Auxiliary contact	OFF-delay time	Model
3PST-NO	SPST-NC	7.5 s	G9SA-EX031-T075
		15 s	G9SA-EX031-T15
		30 s	G9SA-EX031-T30

Note: Set to maximum values in the factory.

* The following 15-step OFF-delay time settings are available:

T075: 0.5, 1, 1.5, 2, 2.5, 3, 3.5, 4, 4.5, 5, 5.5, 6, 6.5, 7, and 7.5 s

T15: 1, 2, 3, 4, 5, 6, 7, 8, 9, 10, 11, 12, 13, 14, and 15 s

T30: 2, 4, 6, 8, 10, 12, 14, 16, 18, 20, 22, 24, 26, 28, and 30 s

Specifications

Ratings

Power Input

Item	Model	G9SA-301/TH301	G9SA-501	G9SA-321-T□
Power supply voltage		24 VAC/VDC: 24 VAC, 50/60 Hz, or 24 VDC 100 to 240 VAC: 100 to 240 VAC, 50/60 Hz		
Operating voltage range		85% to 110% of rated power supply voltage		
Power consumption *		24 VAC/VDC: 1.8 VA/1.7 W max. 100 to 240 VAC: 9 VA max.	24 VAC/VDC: 2.8 VA/2.6 W max. 100 to 240 VAC: 11 VA max.	24 VAC/VDC: 3.5 VA/3.3 W max. 100 to 240 VAC: 12.5 VA max.

* When an Expansion Unit is connected, the power consumption is increased by 2 VA/2 W max.

Inputs

Item	Model	G9SA-301/321-T□/TH301	G9SA-501
Input current *		40 mA max.	60 mA max.

* When an Expansion Unit is connected, the input current is increased by 30 mA max.

Contacts

Item	Model	G9SA-301/501/321-T□/TH301/EX301/EX031-T□
Item	Load	Resistive load
Rated load		250 VAC, 5 A 30 VDC, 5 A
Rated carry current		5 A

Characteristics

Item	Model	G9SA-301/TH301	G9SA-501/321-T□	G9SA-EX301/EX031-T□
Contact resistance *1		100 mΩ		
Operating time *2		30 ms max.		
Response time *3		10 ms max.		
Insulation resistance *4		100 MΩ min. (at 500 VDC)		
Dielectric strength	Between different outputs	2,500 VAC, 50/60 Hz for 1 min		
	Between inputs and outputs			
	Between power inputs and outputs			
	Between power inputs and other inputs (only for 100 to 240-V models)			
Vibration resistance		10 to 55 to 10 Hz, 0.375-mm single amplitude (0.75-mm double amplitude)		
Shock resistance	Destruction	300 m/s ²		
	Malfunction	100 m/s ²		
Durability *5	Mechanical	5,000,000 operations min. (at approx. 7,200 operations/hr)		
	Electrical	100,000 operations min. (at approx. 1,800 operations/hr)		
Failure rate (P Level) (reference value)		5 VDC, 1 mA		
Ambient operating temperature		-25 to 55°C (with no icing or condensation)		
Ambient operating humidity		35% to 85%		
Terminal tightening torque		0.98 N·m		
Weight *6		Approx. 210 g	Approx. 270 g	Approx. 130 g

*1. The contact resistance was measured with 1 A at 5 VDC using the voltage-drop method.

*2. Not including bounce time.

*3. The response time is the time it takes for the main contact to open after the input is turned OFF. Includes bounce time.

*4. The insulation resistance was measured with 500 VDC at the same places that the dielectric strength was checked.

*5. The durability is for an ambient temperature of 15 to 35°C and an ambient humidity of 25% to 75%.

*6. Weight shown is for 24-VAC/VDC type. For 100 to 240-VAC type, add approximately 20 g.

Wiring of Inputs and Outputs

Signal name	Terminal name	Description of operation
Power supply input	A1, A2	The input terminals for power supply. Connect the power source to the A1 and A2 terminals. DC inputs have polarity, so A1 should be connected to the positive side and A2 to the negative side.
Safety input 1	T11, T12	To set the safety outputs in the ON state, the ON state signals must be input to both safety input 1 and safety input 2. Otherwise the safety outputs cannot be in the ON state.
Safety input 2	T21, T22, T23 *1	
Feedback/reset input	T31, T32	To set the safety outputs in the ON state, the ON state signal must be input to T31 - T32. Otherwise the safety outputs cannot be in the ON state.
Instantaneous safety outputs	See below. *2	Turns ON/OFF according to the state of the safety inputs and feedback/reset inputs. During OFF-delay state, the Instantaneous safety outputs are not able to turn ON.
OFF-delayed safety outputs	See below. *2	OFF-delayed safety outputs. The OFF-delay time is set by the OFF-delay preset switch.
Auxiliary output	See below. *2	Synchronized with Instantaneous Safety Output.
Manual/Auto selector input	A, B *3	Switch between Auto Reset and Manual Reset modes.
Ground terminal	PE	Be sure to connect the PE terminal to a protective earth for 100-240 VAC models. Where the 24 VAC/VDC model power supply is not grounded, please be sure to connect the PE to a protective earth.

*1. Terminal T23

Terminal T23 is used for 2-channel input with a positive common (when connecting a safety sensor with a PNP output). When T23 is being used, please open T21 and T22. For 1-channel input, short circuit T12-T23 before use.

*2. Output Contacts

G9SA-301: Safety Output Contacts 13-14, 23-24, 33-34. Auxiliary Contact 41-42.

G9SA-501: Safety Output Contacts 13-14, 23-24, 33-34, 43-44, 53-54. Auxiliary Contact 61-62.

G9SA-321-□: Safety Output Contacts 13-14, 23-24, 33-34. Safety OFF-delay Output Contact 43-44, 53-54. Auxiliary Contact 61-62.

*3. Terminals A and B

A-B Opening: Manual Reset

A-B Short Circuit: Auto Reset

Dimensions and Terminal Arrangement

G9SA-301
 G9SA-501
 G9SA-321-T□
 G9SA-TH301

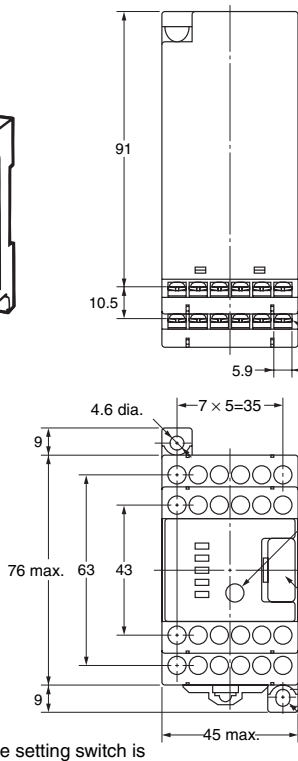
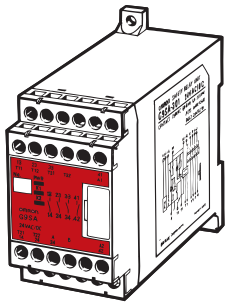

G9SA-301: Twenty, M3
 G9SA-501: Twenty-four, M3
 G9SA-321-T□: Twenty-four, M3
 G9SA-TH301: Twenty-one, M3

Terminal Arrangement

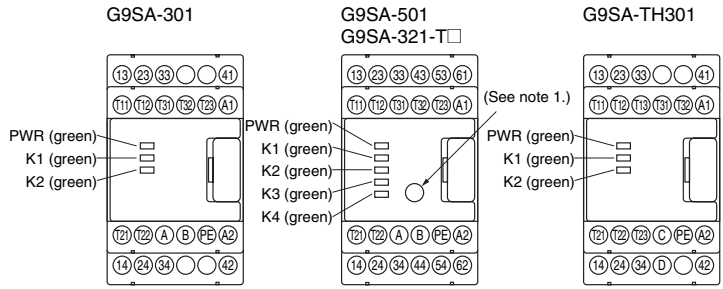

Mounting Holes

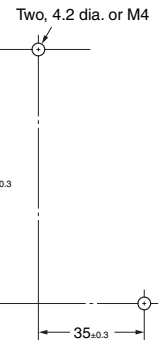

- Note 1:** The OFF-delay time setting switch is found on the G9SA-321-T□ only.
Note 2: The K1 to K4 indicators light when the NO contacts of internal relays K1 to K4 close.
 * Do not remove unless an Expansion Unit is being used.

G9SA-EX301
 G9SA-EX031-T□

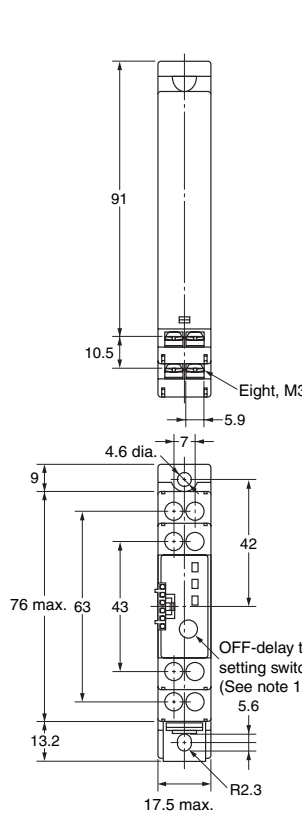
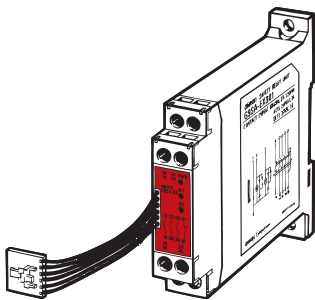

Mounting Holes

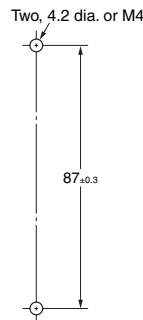

Terminal Arrangement

G9SA-EX301
 G9SA-EX031-T□

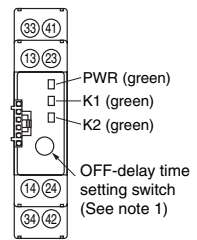

- Note 1:** The OFF-delay time setting switch is found on the G9SA-EX031-T□ only.
Note 2: The K1 and K2 indicators light when the NO contacts of internal relays K1 and K2 close.

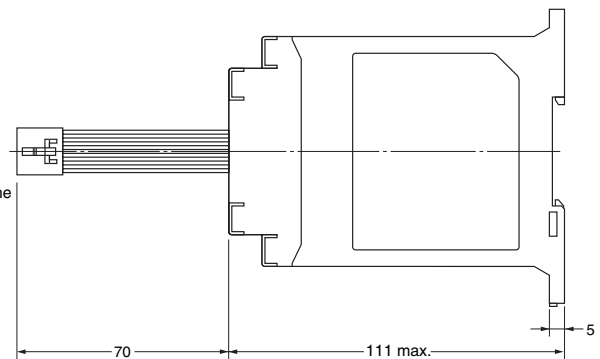

Application Examples

G9SA-301 (24 VAC/VDC) with 2-channel Limit Switch Input/Auto-reset

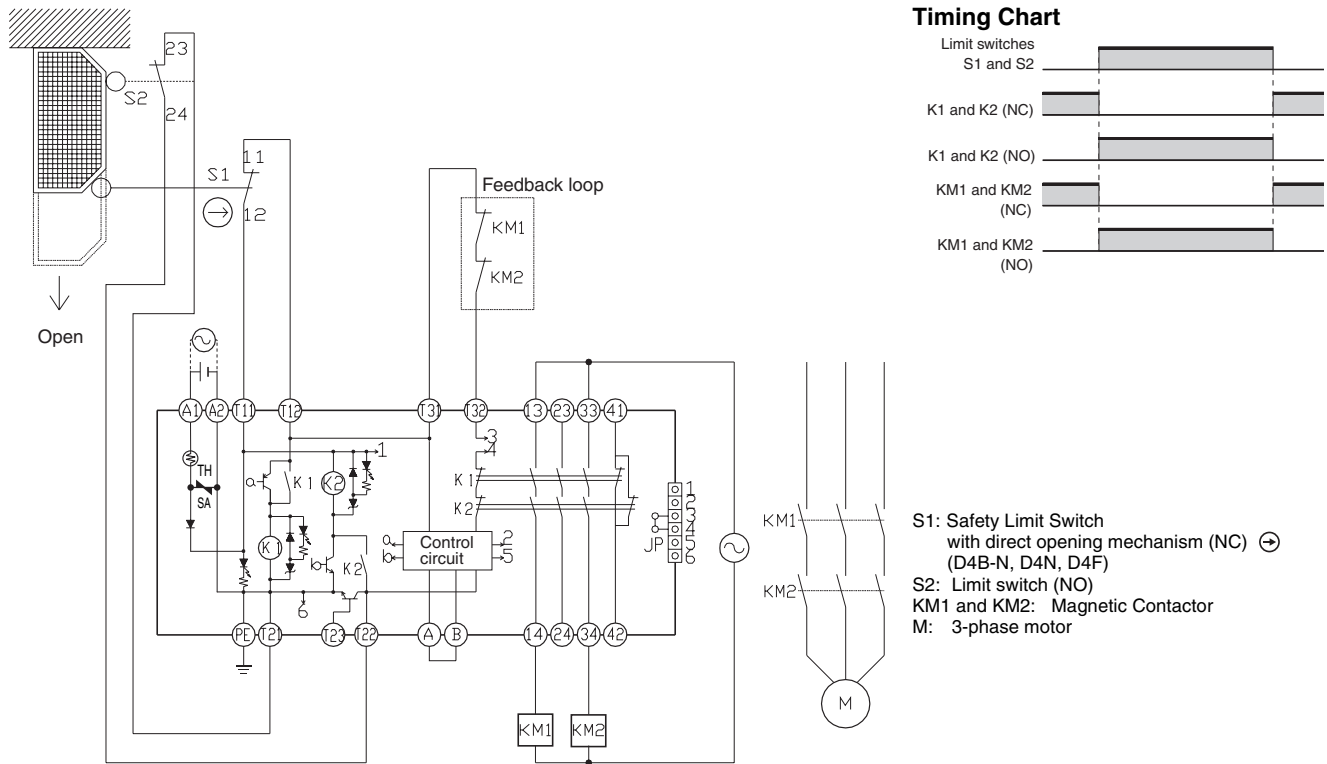

Note: This circuit achieves Safety Category 4.

G9SA-301 (24 VAC/VDC) with 2-channel Limit Switch Input/Manual Reset

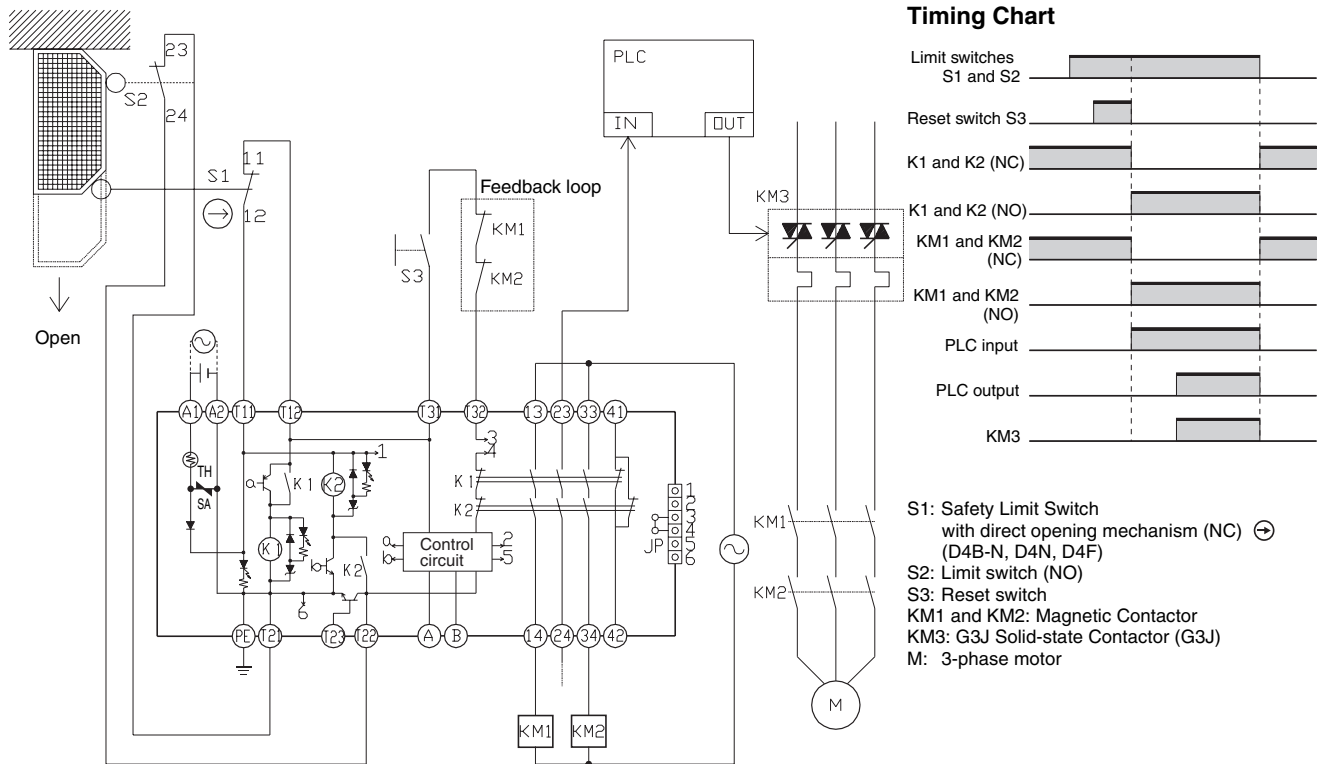

Note: This circuit achieves Safety Category 4.

G9SA-301 (100 to 240 VAC) with 2-channel Limit Switch Input/Auto-reset

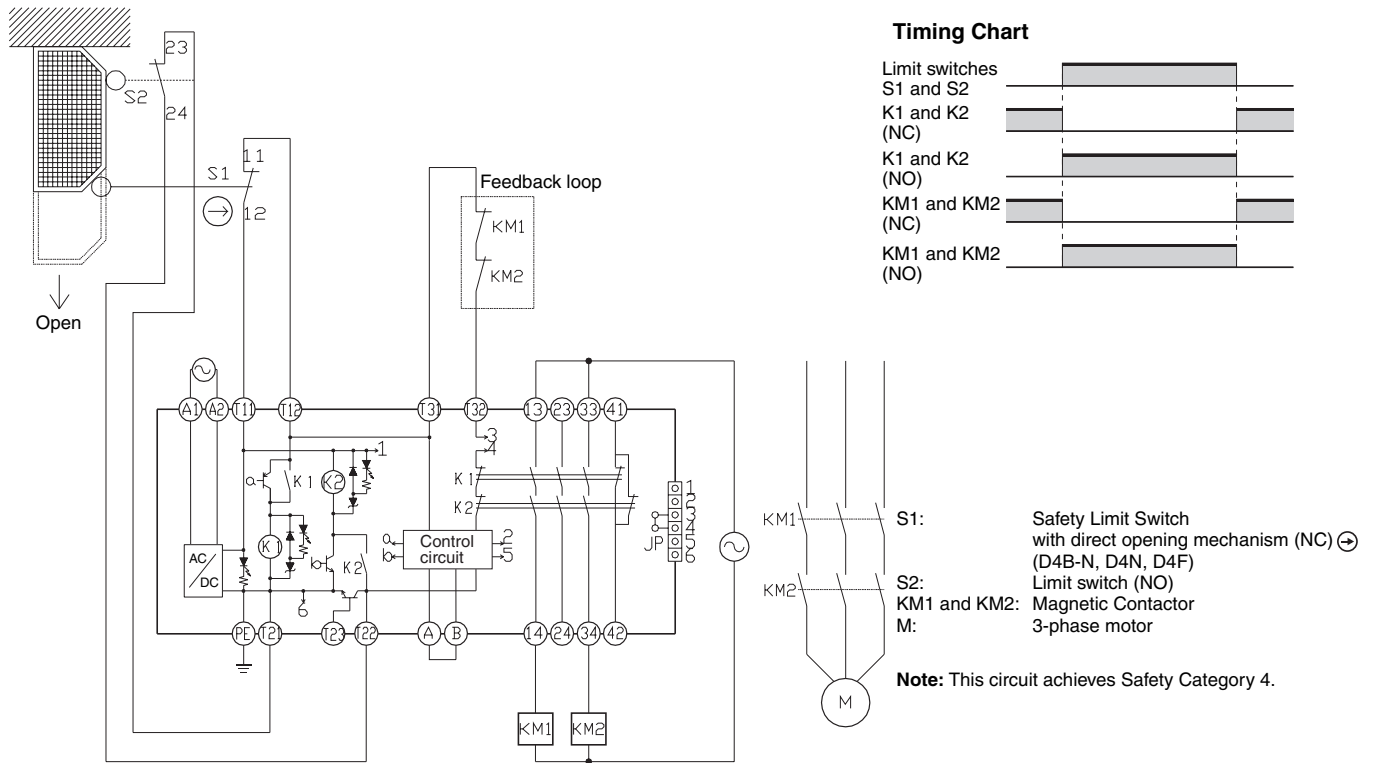

G9SA-301 (24 VAC/VDC) with 2-channel Emergency Stop Switch Input/Manual Reset

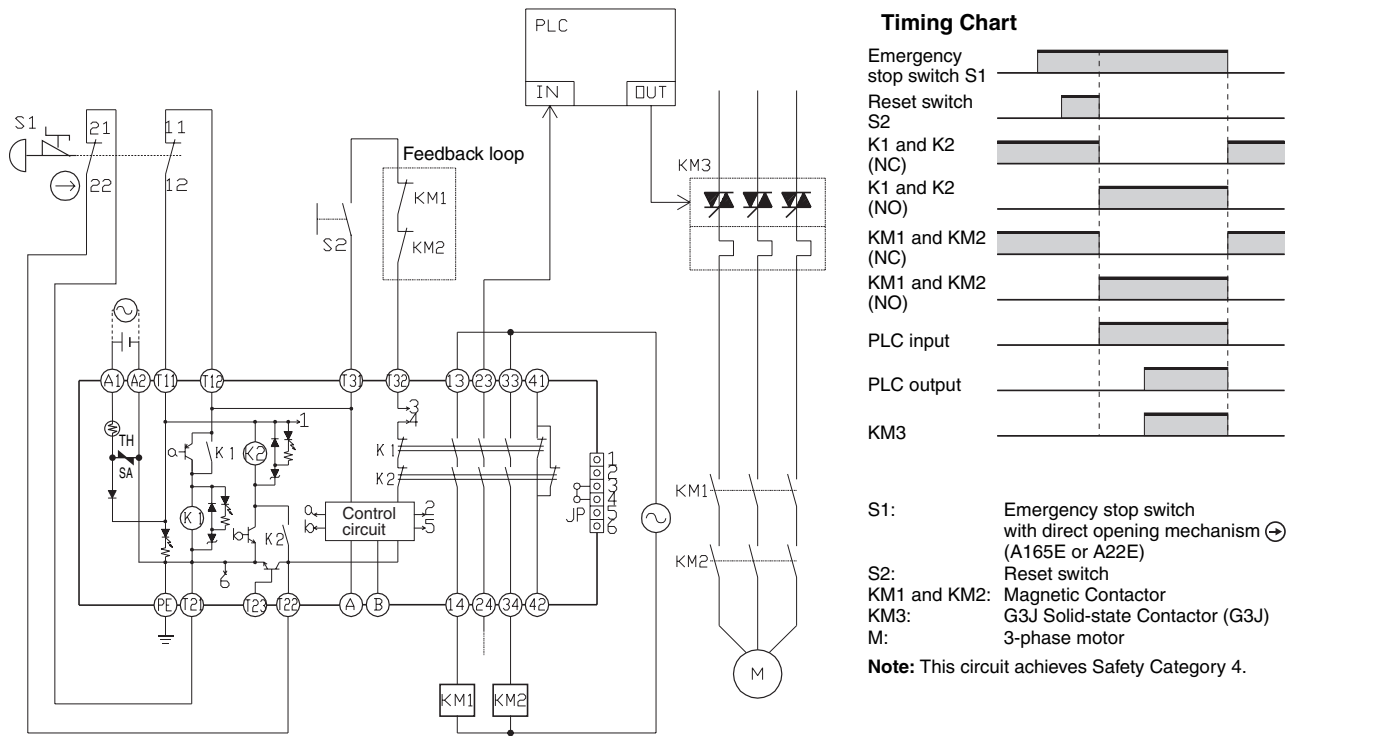

G9SA-321-T□ (24 VAC/VDC) with 2-channel Limit Switch Input/Manual Reset

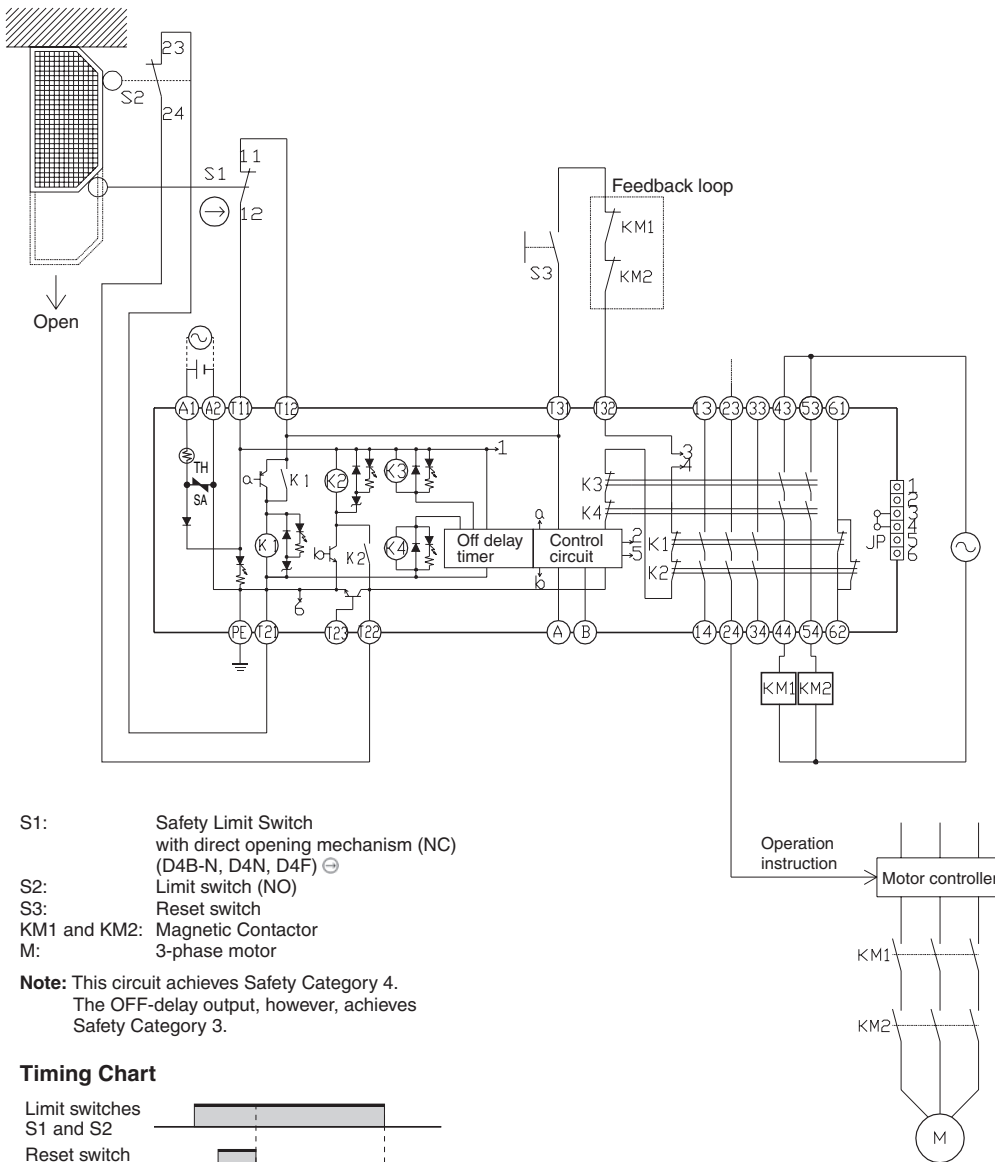

- S1: Safety Limit Switch with direct opening mechanism (NC) (D4B-N, D4N, D4F) ⊖
- S2: Limit switch (NO)
- S3: Reset switch
- KM1 and KM2: Magnetic Contactor
- M: 3-phase motor

Note: This circuit achieves Safety Category 4. The OFF-delay output, however, achieves Safety Category 3.

Timing Chart

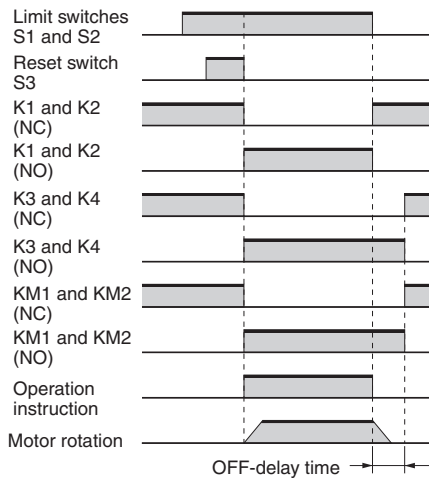

G9SA-321-T□ (24 VAC/VDC) + G9SA-EX031-T□ with 2-channel Limit Switch Input/Manual Reset

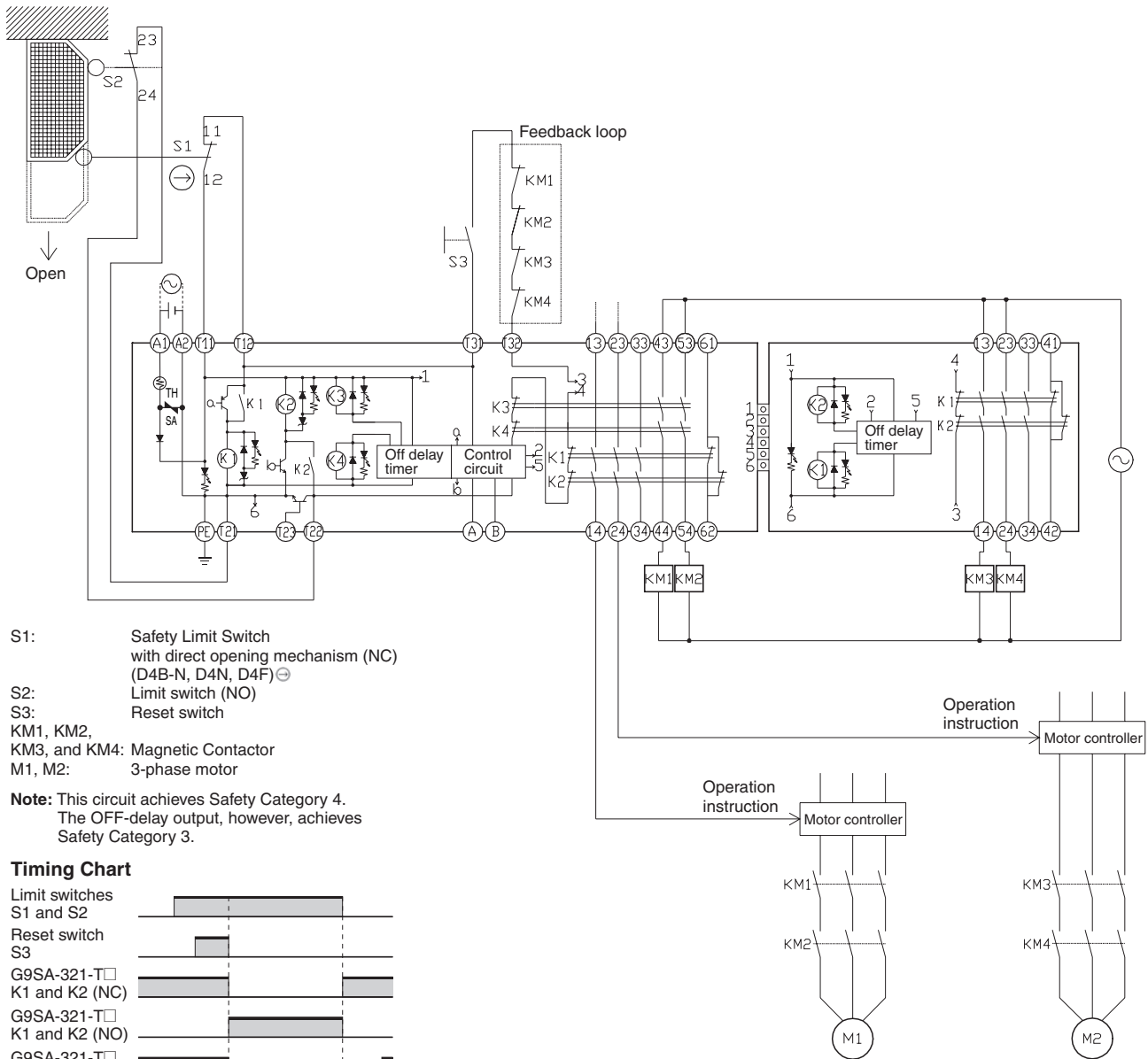

- S1: Safety Limit Switch with direct opening mechanism (NC) (D4B-N, D4N, D4F)⊖
- S2: Limit switch (NO)
- S3: Reset switch
- KM1, KM2, KM3, and KM4: Magnetic Contactor
- M1, M2: 3-phase motor

Note: This circuit achieves Safety Category 4. The OFF-delay output, however, achieves Safety Category 3.

Timing Chart

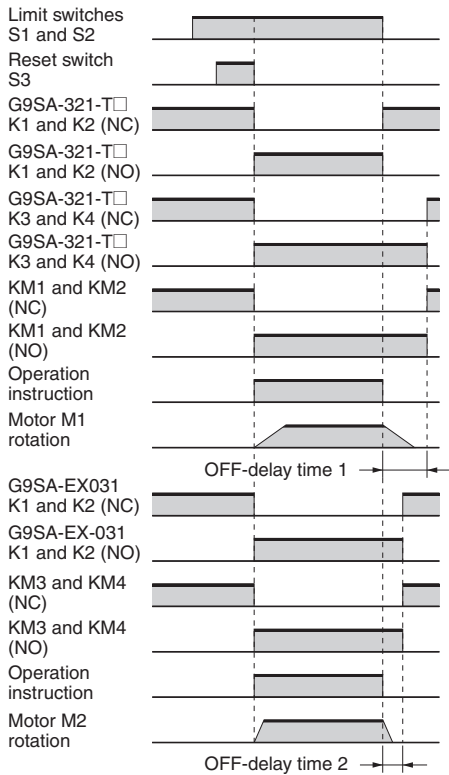

G9SA-301 (24 VAC/VDC) with 2-channel Safety Sensor/Manual Reset (PNP models only)

Timing Chart

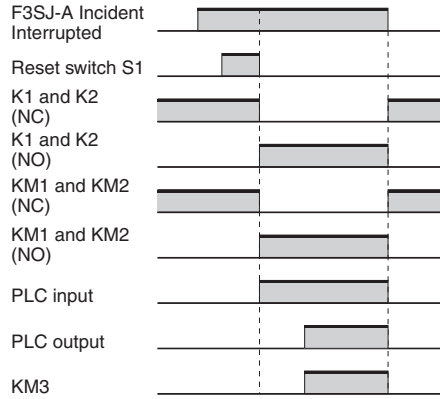

- F3SJ-A: Safety sensor
- S1: Reset switch
- KM1 and KM2: Magnetic Contactor
- KM3: G3J Solid-state Contactor (G3J)
- M: 3-phase motor
- E1: 24-VDC Power Supply (S82K)

Note: This circuit achieves Safety Category 4.
 * The F3SJ-A auxiliary output wiring is shown for dark-ON operation.

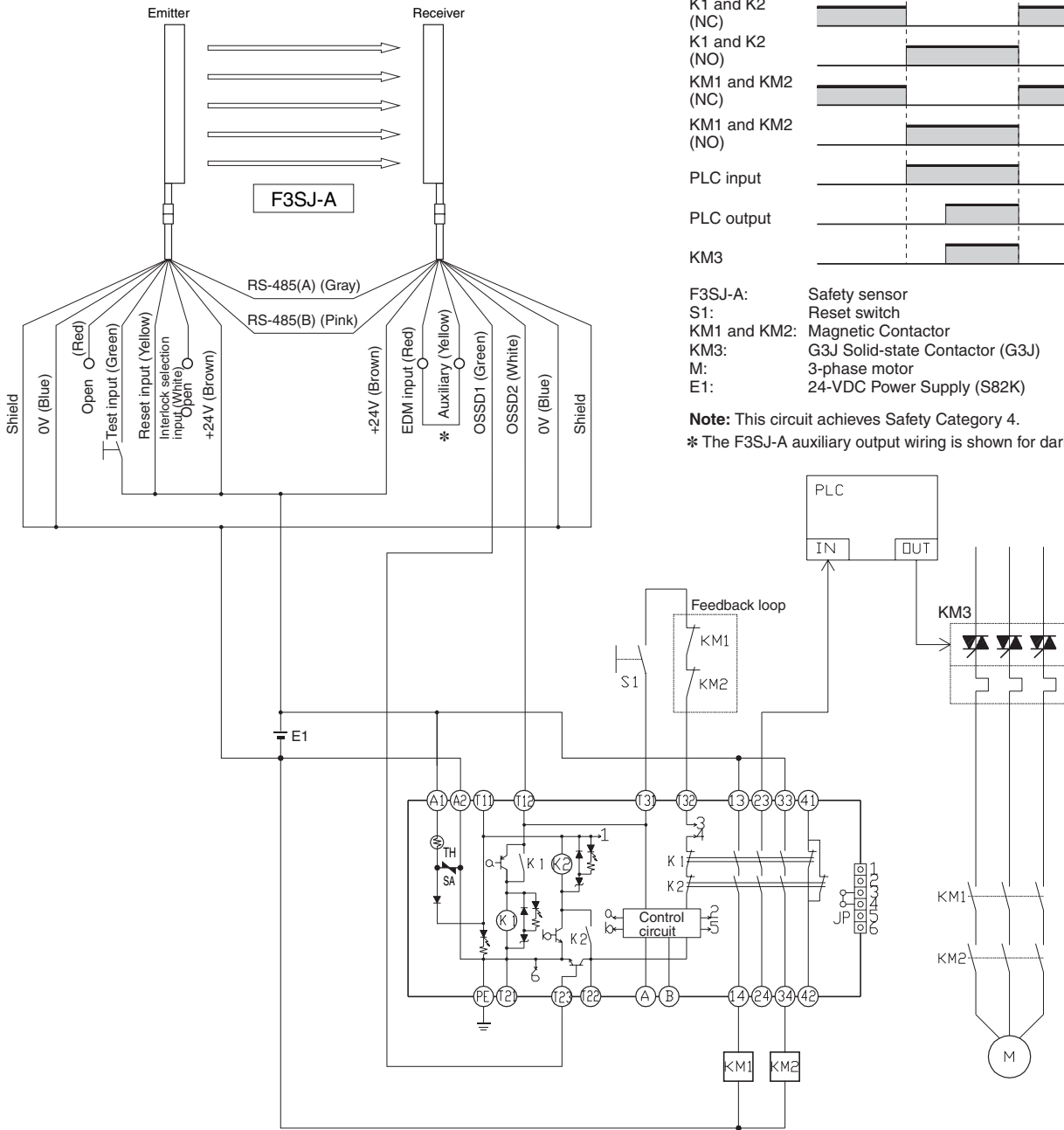

G9SA-TH301 (24 VDC) with 2-hand Inputs

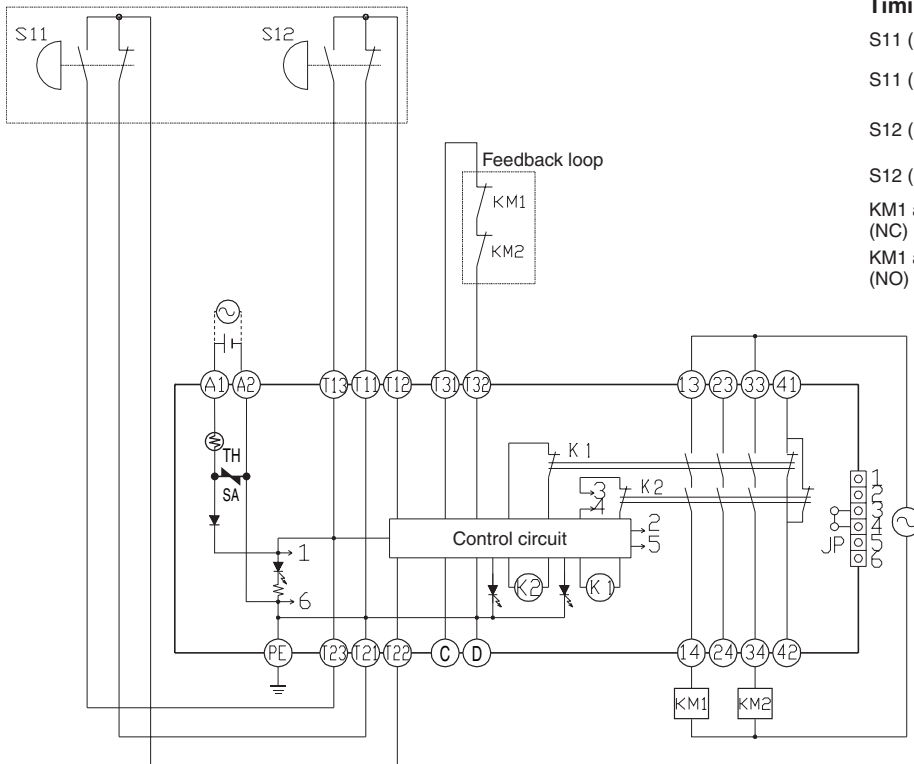

Timing Chart

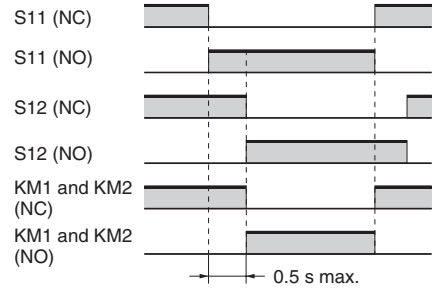

Input time difference operates only when the difference is 0.5 s max.

S11, S12: Two-hand pushbutton switches
 KM1 and KM2: Magnetic Contactor

- Note: 1.** Use a 1NC+1NO switch for S11 and S12.
- Note: 2.** This circuit achieves Safety Category 4.

G9SA-501 (24 VAC/VDC) and G9SA-EX301 with 2-channel Limit Switch Input/Manual Reset

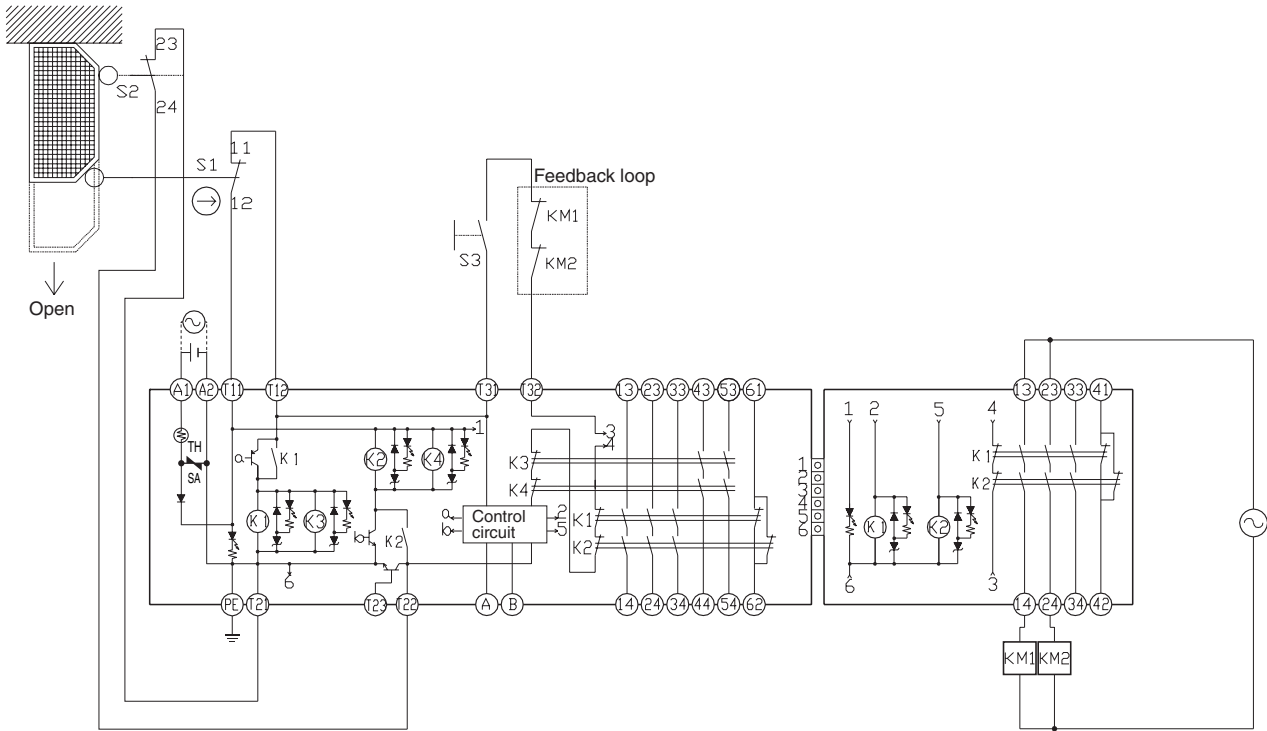

- S1: Safety Limit Switch with direct opening mechanism (NC) (D4B-N, D4N, D4F) ⊖
- S2: Limit switch (NO)
- S3: Reset switch
- KM1 and KM2: Magnetic Contactor
- M: 3-phase motor

Timing Chart

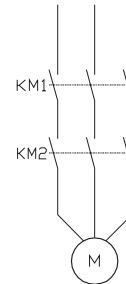
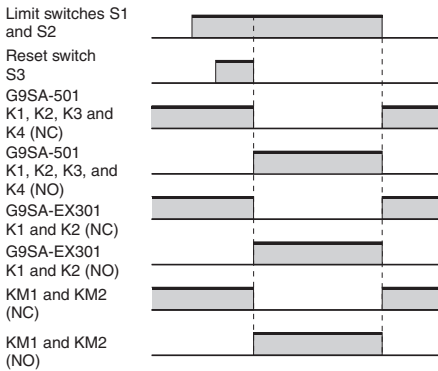

Note: This circuit achieves Safety Category 4.

Safety Precautions

Refer to the “*Precautions for All Relays*” and “*Precautions for All Relays with Forcibly Guided Contacts*”.

CAUTION

Turn OFF the G9SA before wiring the G9SA. Do not touch the terminals of the G9SA while the power is turned ON, because the terminals are charged and may cause an electric shock.



Precautions for Correct Use

Failure Detection for Slow-starting Power Supply

When using a power supply with a long start-up time, if power is switched on while input has been closed the internal circuits will detect a power voltage error and the product will not operate. Apply the voltage to the product once the voltage has reached its rated level.

Installation

The G9SA can be installed in any direction.

Wiring

- Use the following to wire the G9SA.
 - Stranded wire: 0.75 to 1.5 mm²
 - Solid wire: 1.0 to 1.5 mm²
- Tighten each screw to a torque of 0.78 to 1.18 N·m, or the G9SA may malfunction or generate heat.
- External inputs connected to T11 and T12 or T21 and T22 must be no-voltage contact inputs.
- PE is a ground terminal.
 - When a machine is grounded at the positive, the PE terminal should not be grounded.

Connector Cover

Do not remove the connector cover of the G9SA-301, G9SA-501, G9SA-321-T□, or G9SA-TH301 unless an Expansion Unit is being used.

Mounting Expansion Units

- Turn OFF the G9SA before connecting the Expansion Unit.
- When an Expansion Unit is being used, remove the connector cover from the G9SA Safety Relay Unit (G9SA-301, G9SA-501, G9SA-321-T□, or G9SA-TH301) and insert the connector of the Expansion Unit's connector cable.

Mounting Multiple Units

When mounting multiple Units close to each other, the rated current will be 3 A. Do not apply a current higher than 3 A.

Applicable Safety Category (EN954-1)

G9SA-series Relays meet the requirements of Safety Category 4 of the EN954-1 standards when they are used as shown in the examples provided by OMRON. The Relays may not meet the standards in some operating conditions. The OFF-delay output of models G9SA-321-T□ and EX031-T□, however, conform to Safety Category 3.

The applicable safety category is determined from the whole safety control system. Make sure that the whole safety control system meets EN954-1 requirements.

Connecting Inputs

If using multiple G9SA models, inputs cannot be made using the same switch. This is also true for other input terminals.

Incorrect

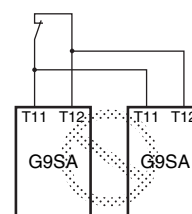

Ground Shorts

The G9SA internal circuits have a positive thermistor (TH) built in, which will detect ground short malfunctions (where S1 and S2 are grounded) and 1-channel and 2-channel short malfunctions, and cut off the safety output. If the short breakdown is repaired, the G9SA automatically recovers.

Resetting Inputs

When only channel 1 of the 2-channel input turns OFF, the safety output is interrupted. In order to restart when this happens, it is necessary to turn OFF and ON both input channels. It is not possible to restart by resetting only channel 1.

Resetting Inputs During OFF Delay Time

The G9SA-321-T□ operates as follows according to the reset mode when the inputs are to be re-entered during the OFF delay time of the G9SA-321-T□:

For auto reset, after the OFF delay time has ended, the outputs will turn OFF, and then the outputs will turn ON again.

For manual reset, after the OFF delay time has ended, the outputs will turn OFF, and then the outputs will turn ON again when the reset is input.

Durability of Contact Outputs

Relay with Forcibly Guided Contact durability depends greatly on the switching condition. Confirm the actual conditions of operation in which the Relay will be used in order to make sure the permissible number of switching operations.

When the accumulated number of operation exceeds its permissible range, it can cause failure of reset of safety control circuit. In such case, please replace the Relay immediately. If the Relay is used continuously without replacing, then it can lead to loss of safety function.

Certified Standards

The G9SA-301/501/321-T□/TH301/EX301/EX031-T□ conform to the following standards.

- EN standards, certified by BG:
 - EN954-1
 - EN60204-1
 - EN574 (G9SA-TH301 only)
- Conformance to EMC (Electromagnetic Compatibility)
 - Certified by TÜV SÜD: G9SA (-TH301) 24 VAC/VDC
 - G9SA-EX301/EX031-T□
 - Certified by TÜV Rheinland: G9SA (-TH301) 100-240 VAC
 - EMI (Emission): EN55011 Group 1 Class A
 - EMS (Immunity): EN61000-6-2
- UL standards: UL508 (Industrial Control Equipment)
- CSA standards: CSA C22.2 No. 14 (Industrial Control Equipment)
- CCC Certification: GB14048.5

Read and Understand This Catalog

Please read and understand this catalog before purchasing the products. Please consult your OMRON representative if you have any questions or comments.

Warranty and Limitations of Liability

WARRANTY

OMRON's exclusive warranty is that the products are free from defects in materials and workmanship for a period of one year (or other period if specified) from date of sale by OMRON.

OMRON MAKES NO WARRANTY OR REPRESENTATION, EXPRESS OR IMPLIED, REGARDING NON-INFRINGEMENT, MERCHANTABILITY, OR FITNESS FOR PARTICULAR PURPOSE OF THE PRODUCTS. ANY BUYER OR USER ACKNOWLEDGES THAT THE BUYER OR USER ALONE HAS DETERMINED THAT THE PRODUCTS WILL SUITABLY MEET THE REQUIREMENTS OF THEIR INTENDED USE. OMRON DISCLAIMS ALL OTHER WARRANTIES, EXPRESS OR IMPLIED.

LIMITATIONS OF LIABILITY

OMRON SHALL NOT BE RESPONSIBLE FOR SPECIAL, INDIRECT, OR CONSEQUENTIAL DAMAGES, LOSS OF PROFITS OR COMMERCIAL LOSS IN ANY WAY CONNECTED WITH THE PRODUCTS, WHETHER SUCH CLAIM IS BASED ON CONTRACT, WARRANTY, NEGLIGENCE, OR STRICT LIABILITY.

In no event shall the responsibility of OMRON for any act exceed the individual price of the product on which liability is asserted.

IN NO EVENT SHALL OMRON BE RESPONSIBLE FOR WARRANTY, REPAIR, OR OTHER CLAIMS REGARDING THE PRODUCTS UNLESS OMRON'S ANALYSIS CONFIRMS THAT THE PRODUCTS WERE PROPERLY HANDLED, STORED, INSTALLED, AND MAINTAINED AND NOT SUBJECT TO CONTAMINATION, ABUSE, MISUSE, OR INAPPROPRIATE MODIFICATION OR REPAIR.

Application Considerations

SUITABILITY FOR USE

OMRON shall not be responsible for conformity with any standards, codes, or regulations that apply to the combination of products in the customer's application or use of the products.

At the customer's request, OMRON will provide applicable third party certification documents identifying ratings and limitations of use that apply to the products. This information by itself is not sufficient for a complete determination of the suitability of the products in combination with the end product, machine, system, or other application or use.

The following are some examples of applications for which particular attention must be given. This is not intended to be an exhaustive list of all possible uses of the products, nor is it intended to imply that the uses listed may be suitable for the products:

- Outdoor use, uses involving potential chemical contamination or electrical interference, or conditions or uses not described in this catalog.
- Nuclear energy control systems, combustion systems, railroad systems, aviation systems, medical equipment, amusement machines, vehicles, safety equipment, and installations subject to separate industry or government regulations.
- Systems, machines, and equipment that could present a risk to life or property.

Please know and observe all prohibitions of use applicable to the products.

NEVER USE THE PRODUCTS FOR AN APPLICATION INVOLVING SERIOUS RISK TO LIFE OR PROPERTY WITHOUT ENSURING THAT THE SYSTEM AS A WHOLE HAS BEEN DESIGNED TO ADDRESS THE RISKS, AND THAT THE OMRON PRODUCTS ARE PROPERLY RATED AND INSTALLED FOR THE INTENDED USE WITHIN THE OVERALL EQUIPMENT OR SYSTEM.

PROGRAMMABLE PRODUCTS

OMRON shall not be responsible for the user's programming of a programmable product, or any consequence thereof.

Disclaimers

CHANGE IN SPECIFICATIONS

Product specifications and accessories may be changed at any time based on improvements and other reasons.

It is our practice to change model numbers when published ratings or features are changed, or when significant construction changes are made. However, some specifications of the products may be changed without any notice. When in doubt, special model numbers may be assigned to fix or establish key specifications for your application on your request. Please consult with your OMRON representative at any time to confirm actual specifications of purchased products.

DIMENSIONS AND WEIGHTS

Dimensions and weights are nominal and are not to be used for manufacturing purposes, even when tolerances are shown.

PERFORMANCE DATA

Performance data given in this catalog is provided as a guide for the user in determining suitability and does not constitute a warranty. It may represent the result of OMRON's test conditions, and the users must correlate it to actual application requirements. Actual performance is subject to the OMRON Warranty and Limitations of Liability.

ERRORS AND OMISSIONS

The information in this document has been carefully checked and is believed to be accurate; however, no responsibility is assumed for clerical, typographical, or proofreading errors, or omissions.

2009.11

In the interest of product improvement, specifications are subject to change without notice.

OMRON Corporation
Industrial Automation Company

<http://www.ia.omron.com/>

(c)Copyright OMRON Corporation 2009 All Right Reserved.