



90.03
See page 90

Module	Socket	Relay	Description	Mounting	Accessories
99.02	90.02	60.12	Screw terminal (Box clamp) socket	Panel or 35 mm rail (EN 50022) mount	- Coil indication and EMC suppression modules - Jumper link - Timer modules - Metal retaining clip
	90.03	60.13	Double A1 terminal		



90.21
See page 91

Module	Socket	Relay	Description	Mounting	Accessories
99.01	90.20	60.12	Screw terminal (Box clamp) socket	Panel or 35 mm rail (EN 50022) mount	- Coil indication and EMC suppression modules - Metal retaining clip
	90.21	60.13			



90.83.3
See page 92

Module	Socket	Relay	Description	Mounting	Accessories
—	90.82.3	60.12	Screw terminal (Box clamp) socket	Panel or 35 mm rail (EN 50022) mount	- Metal retaining clip
—	90.83.3	60.13			

60



90.23
See page 92

Module	Socket	Relay	Description	Mounting	Accessories
—	90.22	60.12	Screw terminal (Box clamp) socket	Panel or 35 mm rail (EN 50022) mount	- Metal retaining clip
—	90.23	60.13			



90.26
See page 93

Module	Socket	Relay	Description	Mounting	Accessories
—	90.26	60.12	Screw terminal (Plate clamp) socket	Panel or 35 mm rail (EN 50022) mount	- Metal retaining clip
—	90.27	60.13			



90.12
See page 93

Module	Socket	Relay	Description	Mounting	Accessories
—	90.12	60.12	Flange mount solder socket	M3 screw fixing	—
—	90.13	60.13			



90.15
See page 93

Module	Socket	Relay	Description	Mounting	Accessories
—	90.14	60.12	PCB socket	PCB	—
—	90.14.1	60.12			
—	90.15	60.13			
—	90.15.1	60.13			



90.03

Approvals
(according to type):



Screw terminal (Box clamp) socket	90.02	90.02.0	90.03	90.03.0
panel or 35 mm rail (EN 50022) mount	Blue	Black	Blue	Black
For relay type	60.12		60.13	
Accessories				
Metal retaining clip			090.33	
6-way jumper link			090.06	
Identification tag			090.00.2	
Modules (see table below)			99.02	
Timer modules (see table below)			86.00, 86.10, 86.20	
Technical data				
Rated values	10 A - 250 V			
Dielectric strength	≥ 2 kV AC			
Protection category	IP 20			
Ambient temperature	°C -40...+70			
⊕ Screw torque	Nm 0.6			
Wire strip length	mm 10			
Max. wire size for 90.02 and 90.03 sockets	solid wire		stranded wire	
	mm ² 1x6 / 2x2.5		1x4 / 2x2.5	
	AWG 1x10 / 2x14		1x12 / 2x14	

60

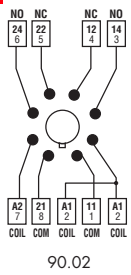

90.02

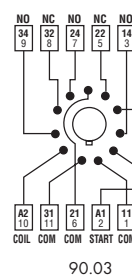
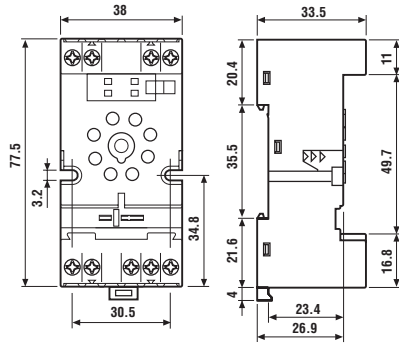

90.03

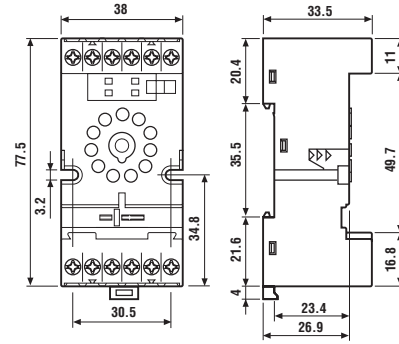

090.06

6-way jumper link for 90.02 and 90.03 sockets	090.06
Rated values	10 A - 250 V

Approvals
(according to type):

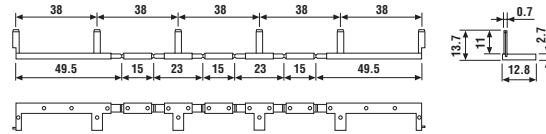

86.00

86 series timer modules (see technical data pages 181/182/187)	
Multi-voltage: (12...240)V AC/DC;	
Multi-functions: AI, DI, SW, BE, CE, DE, EE, FE; (0.05 s... 100 h)	86.00.0.240.0000
Mono-function: (12...24)V AC/DC; function AI; (1.5 s...60 min)	86.10.0.024.0000
Mono-function: (12...24)V AC/DC; function DI; (1.5 s...60 min)	86.20.0.024.0000

Approvals (according to type):



99.02

Approvals
(according to type):



99.02 coil indication and EMC suppression modules (see technical data pages 247/248)	Blue*
Diode (+A1, standard polarity)	(6...220)V DC 99.02.3.000.00
Diode (+A2, non-standard polarity)	(6...220)V DC 99.02.2.000.00
LED	(6...24)V DC/AC 99.02.0.024.59
LED	(28...60)V DC/AC 99.02.0.060.59
LED	(110...240)V DC/AC 99.02.0.230.59
LED + Diode (+A1, standard polarity)	(6...24)V DC 99.02.9.024.99
LED + Diode (+A1, standard polarity)	(28...60)V DC 99.02.9.060.99
LED + Diode (+A1, standard polarity)	(110...220)V DC 99.02.9.220.99
LED + Diode (+A2, non-standard polarity)	(6...24)V DC 99.02.9.024.79
LED + Diode (+A2, non-standard polarity)	(28...60)V DC 99.02.9.060.79
LED + Diode (+A2, non-standard polarity)	(110...220)V DC 99.02.9.220.79
LED + Varistor	(6...24)V DC/AC 99.02.0.024.98
LED + Varistor	(28...60)V DC/AC 99.02.0.060.98
LED + Varistor	(110...240)V DC/AC 99.02.0.230.98
RC circuit	(6...24)V DC/AC 99.02.0.024.09
RC circuit	(28...60)V DC/AC 99.02.0.060.09
RC circuit	(110...240)V DC/AC 99.02.0.230.09
Residual current by-pass (62 kΩ/1W)	(110...240)V AC 99.02.8.230.07

* Modules in Black housing are available on request.



Approvals
(according to type):



Screw terminal (Box clamp) socket	90.20	90.20.0	90.21	90.21.0
panel or 35 mm rail (EN 50022) mount	Blue	Black	Blue	Black
For relay type	60.12		60.13	
Accessories				
Metal retaining clip (supplied with socket - packaging code SMA)			090.33	
Modules (see table below)			99.01	
Technical data				
Rated values	10 A - 250 V			
Dielectric strength	≥ 2 kV AC			
Protection category	IP 20			
Ambient temperature	°C -40...+70			
⊕ Screw torque	Nm 0.5			
Wire strip length	mm 10			
Max. wire size for 90.20 and 90.21 sockets	solid wire		stranded wire	
	mm ²	1x6 / 2x2.5	1x6 / 2x2.5	
	AWG	1x10 / 2x14	1x10 / 2x14	

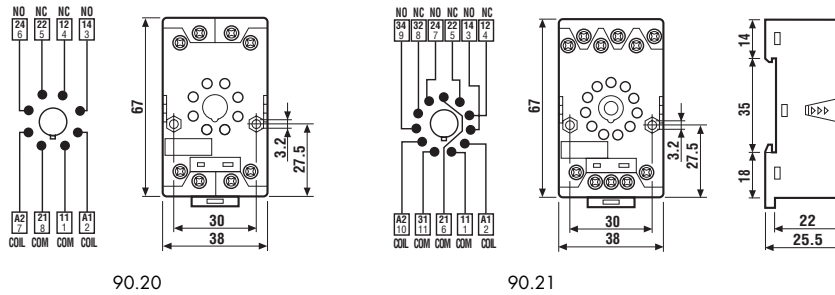

60



Approvals
(according to type):



* Modules in Black housing are available on request.

Green LED is standard.
Red LED available on request.

99.01 coil indication and EMC suppression modules for 90.20 and 90.21 sockets		
See technical data pages 247/248		Blue*
Diode (+A1, standard polarity)	(6...220)V DC	99.01.3.000.00
Diode (+A2, non-standard polarity)	(6...220)V DC	99.01.2.000.00
LED	(6...24)V DC/AC	99.01.0.024.59
LED	(28...60)V DC/AC	99.01.0.060.59
LED	(110...240)V DC/AC	99.01.0.230.59
LED + Diode (+A1, standard polarity)	(6...24)V DC	99.01.9.024.99
LED + Diode (+A1, standard polarity)	(28...60)V DC	99.01.9.060.99
LED + Diode (+A1, standard polarity)	(110...220)V DC	99.01.9.220.99
LED + Diode (+A2, non-standard polarity)	(6...24)V DC	99.01.9.024.79
LED + Diode (+A2, non-standard polarity)	(28...60)V DC	99.01.9.060.79
LED + Diode (+A2, non-standard polarity)	(110...220)V DC	99.01.9.220.79
LED + Varistor	(6...24)V DC/AC	99.01.0.024.98
LED + Varistor	(28...60)V DC/AC	99.01.0.060.98
LED + Varistor	(110...240)V DC/AC	99.01.0.230.98
RC circuit	(6...24)V DC/AC	99.01.0.024.09
RC circuit	(28...60)V DC/AC	99.01.0.060.09
RC circuit	(110...240)V DC/AC	99.01.0.230.09
Residual current by-pass (62 kΩ/1W)	(110...240)V AC	99.01.8.230.07



90.83.3

Approvals
(according to type):



Screw terminal (Box clamp) socket	90.82.3	90.82.30	90.83.3	90.83.30
panel or 35 mm rail (EN 50022) mount	Blue	Black	Blue	Black
For relay type	60.12		60.13	
Accessories				
Metal retaining clip	090.33			
Technical data				
Rated values	10 A - 250 V			
Dielectric strength	≥ 2 kV AC			
Protection category	IP 20			
Ambient temperature	°C -40...+70			
Screw torque	Nm 0.8			
Max. wire size for 90.82.3 and 90.83.3 sockets	solid wire		stranded wire	
	mm ² 1x6 / 2x4		1x6 / 2x4	
	AWG 1x10 / 2x14		1x10 / 2x14	

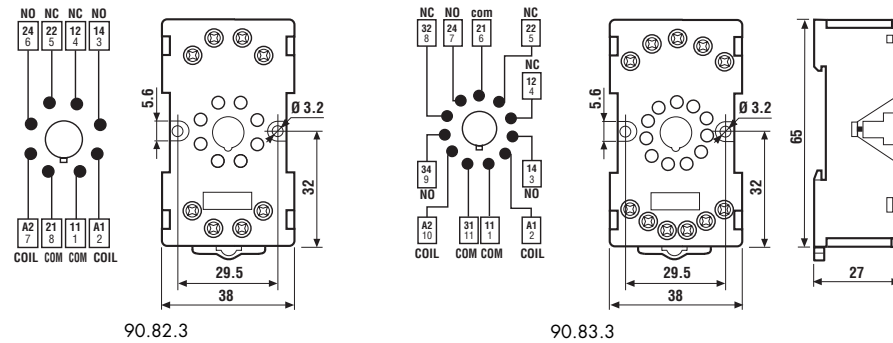

60



90.23

Approvals
(according to type):



Screw (Box clamp) terminal socket	90.22 (blue)	90.23 (blue)
panel or 35 mm rail (EN 50022) mount		
For relay type	60.12	60.13
Accessories		
Metal retaining clip (supplied with socket - packaging code SMA)	090.33	
Technical data		
Rated values	10 A - 250 V	
Dielectric strength	≥ 2 kV AC	
Protection category	IP 20	
Ambient temperature	°C -40...+70	
Screw torque	Nm 0.5	
Wire strip length	mm 7	
Max wire size for 90.22 and 90.23 sockets	solid wire	
	mm ² 1x6 / 2x2.5	
	AWG 1x10 / 2x14	

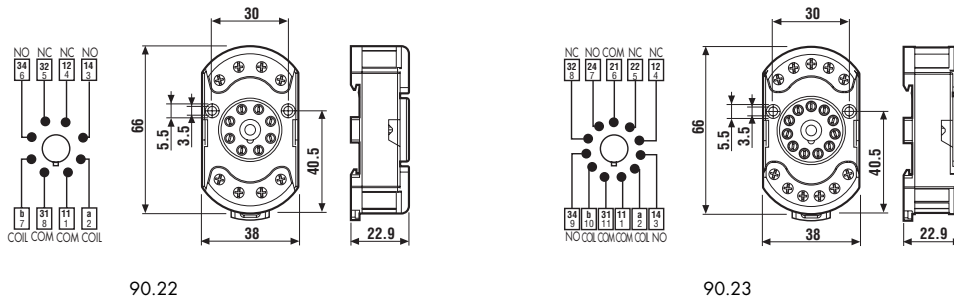



Approvals
(according to type):



Screw terminal (Plate clamp) socket	90.26	90.26.0	90.27	90.27.0
panel or 35 mm rail (EN 50022) mount	Blue	Black	Blue	Black
For relay type	60.12		60.13	
Accessories				
Metal retaining clip (supplied with socket - packaging code SMA)	090.33			
Technical data				
Rated values	10 A - 250 V			
Dielectric strength	≥ 2 kV AC			
Protection category	IP 20			
Ambient temperature	°C -40...+70			
⊕ Screw torque	Nm 0.8			
Wire strip length	mm 10			
Max. wire size for 90.26 and 90.27 sockets	solid wire		stranded wire	
	mm ² 1x4 / 2x2.5		1x4 / 2x2.5	
	AWG 1x12 / 2x14		1x12 / 2x14	

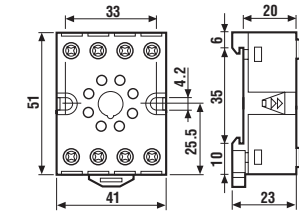
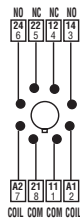

90.26

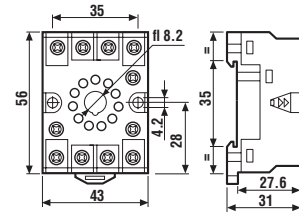
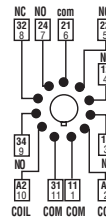

90.27

60



Approvals
(according to type):



Flange mount solder socket mount with M3 screw	90.12 (black)	90.13 (black)
For relay type	60.12	60.13
Technical data		
Rated values	10 A - 250 V	
Dielectric strength	≥ 2 kV AC	
Ambient temperature	°C -40...+70	

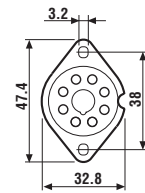

90.12

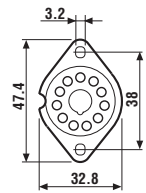

90.13



Approvals
(according to type):



PCB socket	Blue	90.14	90.15
	Blue	90.14.1 (Ø 17.5mm)	90.15.1 (Ø 19mm)
For relay type		60.12	60.13
Technical data			
Rated values	10 A - 250 V		
Dielectric strength	≥ 2 kV AC		
Ambient temperature	°C -40...+70		

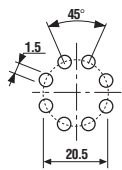

90.14

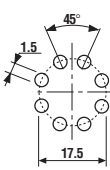

90.14.1

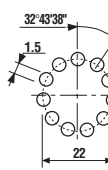

90.15

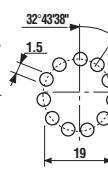

90.15.1

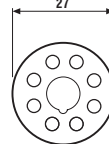

90.14

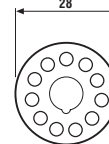

90.15

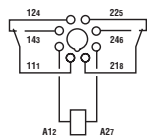

90.14

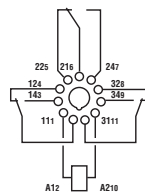

90.15

Packaging code

How to code and identify retaining clip and packaging options for sockets.

Code options according to the last three letters:

