

PBC series

IEC-Type Contactors & Accessories 9-80 Amp AC-3, 25-125 Amp AC-1 AC Coils

UL File E38802 (PBC)



Users should thoroughly review the technical data before selecting a product part number. It is recommended that users also seek out the pertinent approval files of the agencies/laboratories and review them to confirm the product meets the requirements for a given application.

RoHS Ready



Features

- Three pole switching (main contacts) plus integral auxiliary contacts.
- Designed to snap onto DIN rail or mount directly to a panel with screws.
- Efficient 50/60 Hz coils (50 Hz or 60 Hz coils optional).
- Finger-safe (IP 20) terminals.
- Modular design allows contactors and accessories to snap together.
- Comply with IEC EN60947-4-1 & EN60947-5-1; UL508; CSA22.2 No. 14.

Main Contact Data

Arrangements: 3 Form X (3PST-NO-DM).

Ratings: Insulation Voltage (U_i): 690V

See Main Contact Ratings table below.

Auxiliary Contact Data

Arrangements: 1 Form A (SPST-NO), 1 Form B (SPST-NC) or 1 Form A + 1 Form B (SPST-NO + SPST-NC).

Ratings: Insulation Voltage (U_i): 690V.

AC-15: 360VA.

DC-13: 33W.

Conventional Thermal Current (I_{th}): 10A.

Initial Dielectric Strength

Between Contacts and Coil: 2,500V for 1 minute.

Between Open Contacts: 2,500V for 1 minute.

Between Poles: 2,500V for 1 minute.

Electrical Life

Contactor Rating Code	AC-3 (6I _e , I _e)		AC-4 (6I _e , I _e)			
	Cycles	Cycles/Hr	Rated Operating Current (I _e A)		Cycles	Cycles/hr
			380V	660V		
009	1,000,000	1200	3.5	1.5	200,000	300
012	1,000,000	1200	5	2	200,000	300
018	1,000,000	1200	7.7	3.8	200,000	150
025	1,000,000	1200	8.5	4.4	200,000	150
032	800,000	600	12	7.5	200,000	150
040	800,000	600	18.5	9	150,000	150
050	600,000	600	24	12	150,000	150
065	600,000	600	28	14	150,000	150
080	600,000	600	37	17.3	100,000	150

Main Contact Ratings

Rating Code	Contact Material	Maximum Current			Maximum Horsepower						Three Phase				Control Power				
		Inductive AC3		Resistive AC1	Single Phase	Three Phase					FLA				kW				
		Amp (I _e)				690VAC													
		380VAC	660VAC	690VAC			115VAC	230VAC	220VAC	380VAC	440VAC	600VAC	220VAC	380VAC	440VAC	600VAC	220VAC	380VAC	415VAC
009	Cu-AgNi 90/10	9	6.6	25	0.5	1	3	5	5	7.5	9.6	9.7	7.6	9	2.2	4	4	4	5.5
012	Cu-AgNi 90/10	12	8.9	25	1	2	5	7.5	7.5	10	15.2	14	11	11	3	5.5	5.5	5.5	7.5
018	AgNi	18	12	32	1	3	5	10	10	10	15.2	18	14	17	4	7.5	9	9	10
025	AgCd012	25	18	40	2	3	7.5	10	15	20	22	18	21	22	5.5	11	11	11	15
032	AgCd012	32	21	50	2	5	10	15	20	25	28	27	27	27	7.5	15	15	15	18.5
040	AgCd012	40	34	60	3	7.5	15	25	30	40	42	44	40	41	11	18.5	22	22	30
050	AgCd012	50	39	80	3	10	20	30	40	50	54	54	54	54	15	22	25	30	33
065	AgCd012	65	42	80	5	15	25	40	50	60	68	66	65	62	18.5	30	37	37	37
080	AgCd012	80	49	125	7.5	15	30	50	60	75	80	83	77	77	22	37	45	45	45

Coil Data

Voltage: From 24 to 415VAC. See Ordering Information chart for specifics.

Must-Operate Voltage: 85 to 110% of nominal (U_S).

Must-Release Voltage: 20 to 75% of nominal (U_S).

Coil Data

Contactor Rating Code	Maximum VA		Operate & Release Times (ms)	
	Inrush	Sealed	Operate	Release
009	80	9.4	12-22	4-12
012	80	9.4	12-22	4-12
018	80	9.4	12-22	4-12
025	110	11	15-24	5-19
032	110	11	15-24	5-19
040	230	32	20-26	8-12
050	230	32	20-26	8-12
065	230	32	20-26	8-12
080	230	32	20-35	6-20

Environmental Data

Temperature Range:

Operating: -5°C to +40°C at RH or 50% or less. Higher humidity is permissible at lower temperatures.

Storage: -25°C to +55°C

Maximum Altitude: 2000m

Pollution Class: 3

Vibration: 2-13.2 Hz, ±1mm

Shock Resistance: 13.2-100 Hz, ±7m/s²

Short Circuit

Contactor Rating Code	009	012	018	025	032	040	050	065	080
Type of Coord. Main Circuit	Type "2"								
Main Circuit Fuse Type	RT16-16	RT16-20	RT16-25	RT16-32	RT16-50	RT16-63	RT16-63	RT16-80	RT16-100
Aux. Circuit Fuse Type	RT16-10								
Short Circuit Current A Aux. Circuit	1,000								

Load/Life Curves

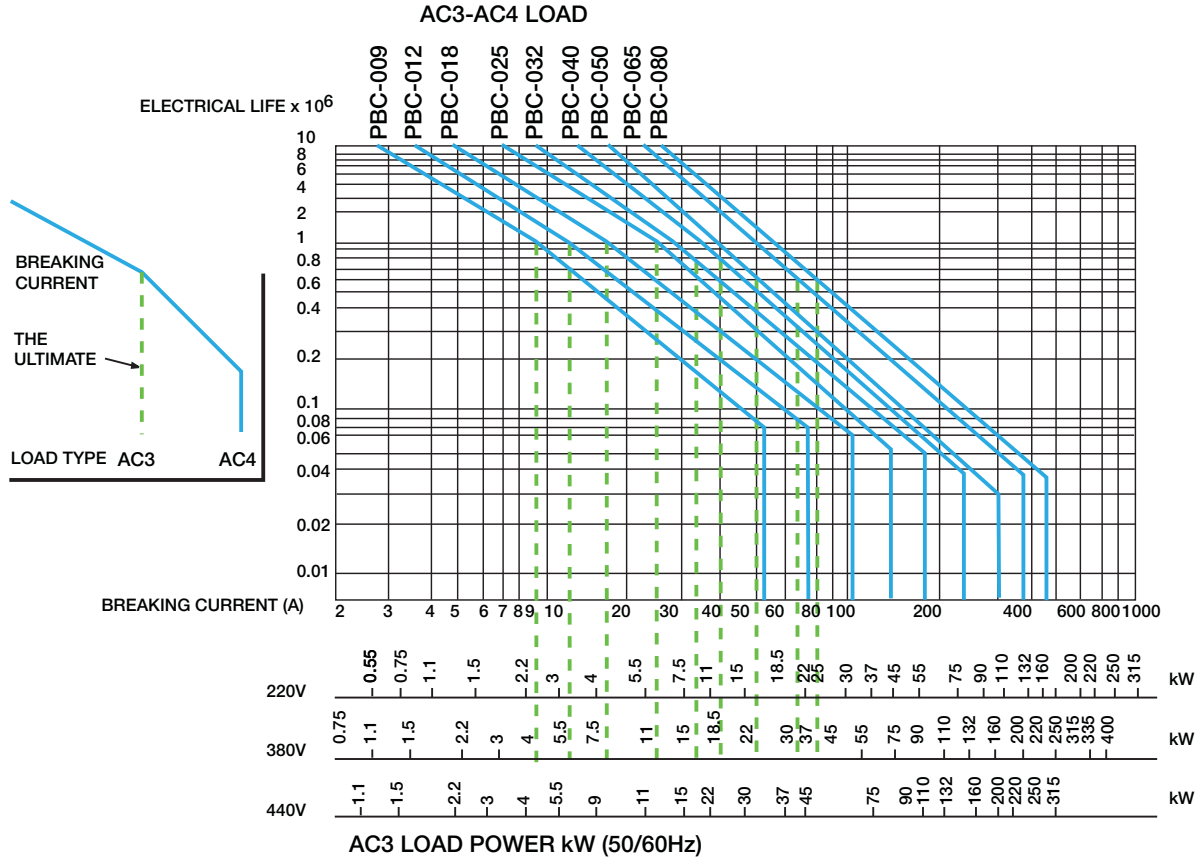

Mechanical Data

Mounting: 009-032 models: 35mm DIN rail or two mounting screws.
 040-080 models: 75mm DIN rail or two mounting screws.
Mounting Orientation: Contactor must be mounted to vertical surface ($\pm 30^\circ$); however, the contactor may be rotated 360° about its axis.

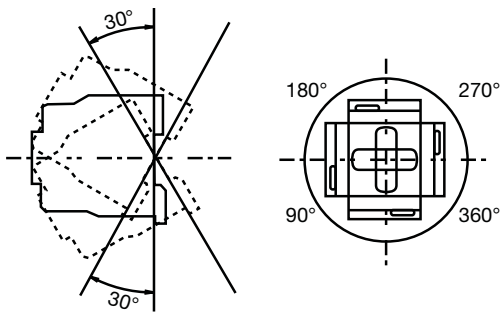

Termination: Finger-safe (IP 20) screw clamps.
Approximate Weight: 009 & 012 models: 0.77 lb (0.35 kg).
 018 models: 0.82 lb (0.37 kg).
 025 & 032 models: 1.23 lb (0.56 kg).
 040, 050 & 065 models: 3.11 lb (1.41 kg).
 080 models: 3.55 lb (1.61 kg).

Ordering Information

Typical Part No. ▶	PBC	-009	A	1	B7
---------------------------	------------	-------------	----------	----------	-----------

- 1. Type:**
PBC = IEC Contactors
- 2. Main Contact Rating Code (AC-3):**
 009 = 9A 012 = 12A 018 = 18A
 025 = 25A 032 = 32A 040 = 40A
 050 = 50A 065 = 65A 080 = 80A
- 3. Main Contact Arrangement & Termination:**
 A = 3 Form X (3PST-NO-DM) with screw clamps.
- 4. Integral Auxiliary Contact Form:**
 1 = 1 NO (9-32A models only)
 2 = 1 NC (9-32A models only)
 3 = 1 NO + 1 NC (40-80A models only)
- 5. Coil Voltage:**
 B7 = 24VAC 50/60 Hz
 E7 = 48VAC 50/60 Hz
 F = 110VAC 50 Hz / 120VAC 60 Hz (40-80A models only)
 F7 = 110-120VAC 50/60 Hz (9-32A models only)
 M = 220VAC 50 Hz / 240VAC 60 Hz (40-80A models only)
 M7 = 220-240VAC 50/60 Hz (9-32A models only)
 Q = 380VAC 50 Hz / 415VAC 60 Hz

NOTES: All part numbers are RoHS compliant.
 PBC-018 is still to be submitted for UL testing. This model is not UL Listed.

Outline Dimensions

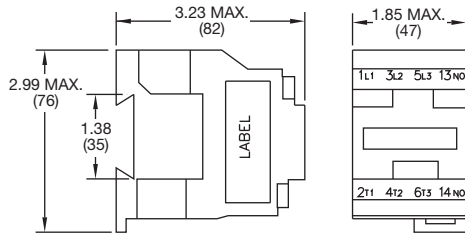

PBC-009 & PBC-012

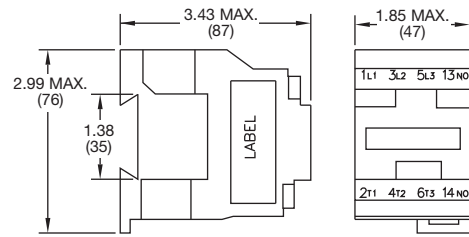

PBC-018

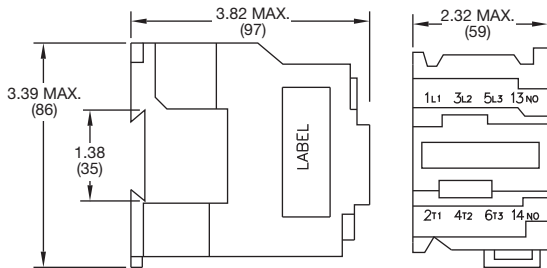

PBC-025

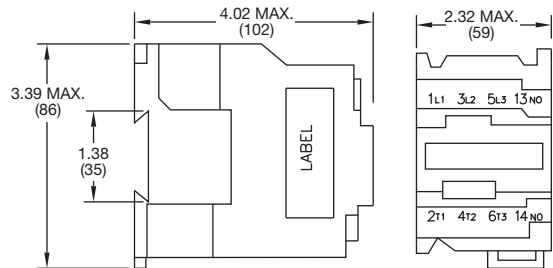

PBC-032

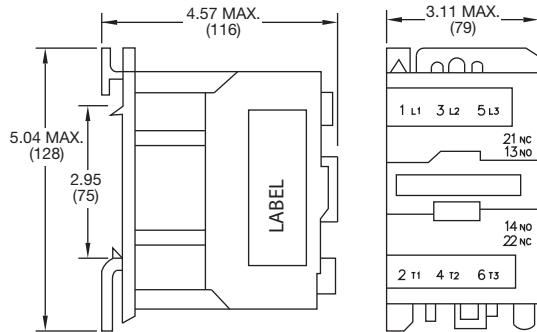

PBC-040, PBC-050 & PBC-065

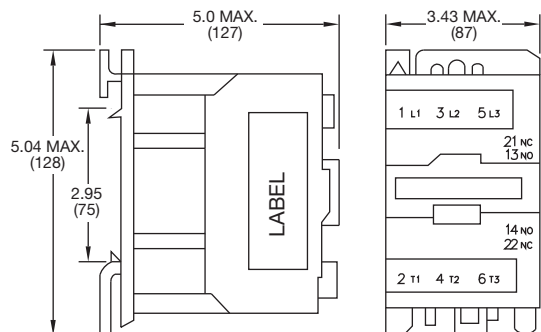

PBC-080

Mounting Dimensions

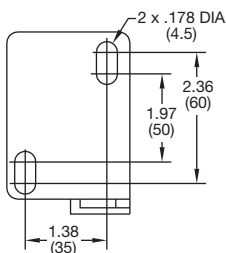

PBC-009, PBC-012 & PBC-018

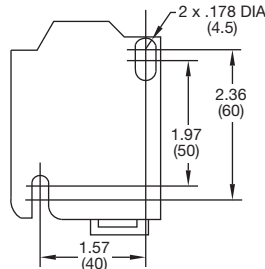

PBC-025 & PBC-032

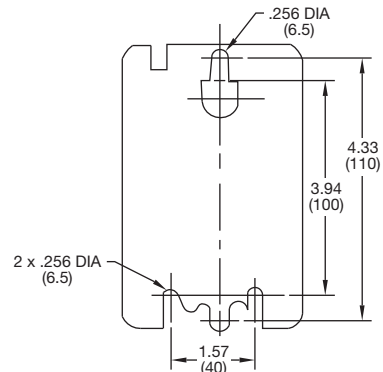

PBC-040, PBC-050, PBC-065 & PBC-080

PBO series

Bimetallic Thermal Overload Relay for PBC series IEC-Type Contactors



UL US File E60363 (PBO)



Users should thoroughly review the technical data before selecting a product part number. It is recommended that users also seek out the pertinent approvals files of the agencies/laboratories and review them to confirm the product meets the requirements for a given application.

Features

- 1 NO & 1 NC auxiliary contacts
- Manual/automatic reset
- Trip indicator
- Stop button
- Test function
- Tamper resistant cover
- Mounts directly on contactor

Auxiliary Contact Data

Arrangements: 1 Form A + 1 Form B (SPST-NO + SPST-NC).
Ratings: Insulation Voltage (U_i): 690V.
 AC-14/AC-15: 1.72A / 230V, 1A / 400V.
 DC-13: 0.3A / 110V, 0.15A / 220V.
 Conventional Thermal Current (I_{th}): 5A.

Electrical Specifications

Trip Class (per IEC 60947-4-1): Class 10.
Rated Insulation Voltage U_i (pollution degree 3): 690V.
Rated Inpulse Withstand Voltage U_{imp}: 6,500V.
Temperature Compensation: Up to 60°C.
Permissible Rated Current: At 60°C: 100%; At 70°C: 87%.

Operating Durability

Expected Life: 3000 cycles.

Current Setting Range

Model Number	Current Setting Range RC (A)	Controlled Power (AC-3) (kW)					For Contactor Type	Fuse for Short Protection (A)	
		220V	380V	415V	440V	660V		aM	gG
PBO-09P1016	0.1 - 0.16						09 - 32A	0.25	2
PBO-09P1625	0.16 - 0.25						09 - 32A	0.5	2
PBO-09P2540	0.25 - 0.40						09 - 32A	1	2
PBO-09P4063	0.40 - 0.63					0.37	09 - 32A	1	2
PBO-09P6310	0.63 - 1.0					0.55	09 - 32A	2	4
PBO-09D1016	1.0 - 1.6		.37		0.55	0.75 1.11	09 - 32A	2	4
PBO-09D1625	1.6 - 2.5	.37	0.55 0.75	1.1	0.75 1.1	1.5	09 - 32A	4	6
PBO-09D2540	2.5 - 4	0.55 0.75	1.1 1.5	1.5	1.5	2.2 3	09 - 32A	6	10
PBO-09D4060	4.0 - 6	1.1	2.2	2.2	2.2	4	09 - 32A	8	16
PBO-09D5580	5.5 - 8	1.5	3	3 3.7	3 3.7	5.5	09 - 32A	12	20
PBO-09A0710	7 - 10	2.2	4	4	4	7.5	09 - 32A	12	20
PBO-12A0913	9 - 13	3	5.5	5.5	5.5	10	12 - 32A	16	25
PBO-18A1218	12 - 18	4	7.5	9	9	15	18 - 32A	20	35
PBO-25A1725	17 - 25	5.5	11	11	11	18.5	25 - 32A	25	50
PBO-32A2332	23 - 32	7.5	15	15	15	22	32A	40	63
PBO-32A2836	28 - 36	10	18.5	22	22	30	32A	40	80
PBO-40A2332	23 - 32	7.5	15	15	15	22	40 - 80A	40	63
PBO-40A3040	30 - 40	10	18.5	22	22	30	40 - 80A	40	80
PBO-50A3750	37 - 50	11	22	25	25	37	50 - 80A	63	10
PBO-65A4865	48 - 65	15	25	30	30	45	65 - 80A	63	10
PBO-65A5570	55 - 70	18.5	30	37	37	55	65 - 80A	80	125
PBO-80A6380	63 - 80	22	37	45	45	75	80A	80	125

Ordering Information

Typical Part No. ▶	PBO	-09	A0710
1. Type: PBO = Bimetallic Thermal Overload Relay for use with PBC series IEC Contactors			
2. Contactor Size For Which Overload Relay is Designed (AC-3 Main Contact Rating of Contactor): 09 = 9-32A 12 = 12-32A 18 = 18-32A 25 = 25-32A 32 = 32A 40 = 40-80A 50 = 50-80A 65 = 65-80A 80 = 80A			
3. Overload Relay Rating (Amps): For this size... These rating ranges are available...			
9-32A contactors:	P1016 = 0.1 to 0.16A P1625 = 0.16 to 0.5A P2540 = 0.25 to 0.4A	P4063 = 0.4 to 0.63A P6310 = 0.63 to 1.0A D1016 = 1.0 to 1.6A	D1625 = 1.6 to 2.5A D2540 = 2.5 to 4.0A D4060 = 4.0 to 6.0A D5580 = 5.5 to 8.0A A0710 = 7.0 to 10.0A A0913 = 9.0 to 13.0A
12-32A contactors:	A0913 = 9.0 to 13.0A		
18-32A contactors:	A1218 = 12.0 to 18.0A		
25-32A contactors:	A1725 = 17.0 to 25.0A		
32A contactors:	A2332 = 23.0 to 32.0A	A2836 = 28.0 to 36.0A	
40-80A contactors:	A2332 = 23.0 to 32.0A	A3040 = 30.0 to 40.0A	
50-80A contactors:	A3750 = 37.0 to 50.0A		
65-80A contactors:	A4865 = 48.0 to 65.0A	A5570 = 55.0 to 70.0A	
80A contactors:	A6380 = 63.0 to 80.0A		

NOTES: All models are RoHS compliant.
 PBO-32A2836, PBO-65A4865, PBO-65A5570 and PBO-80A6380 are still to be submitted for UL testing. These models are not UL Listed.

Outline Dimensions

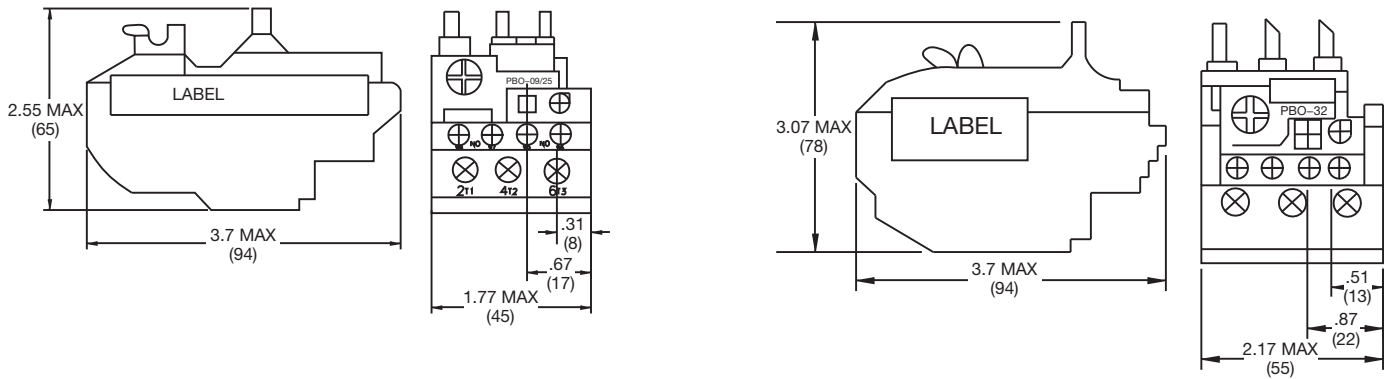

PBO-09, PBO-12, PBO-18 & PBO-25

PBO-32

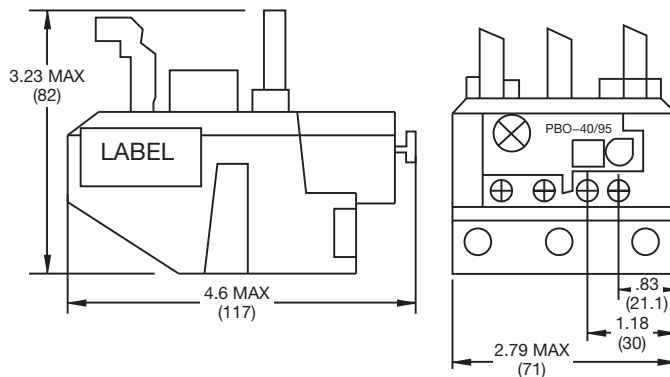

PBO-40, PBO-50, PBO-65 & PBO-80



PBA series

Auxiliary Contact Blocks for use with PBC series IEC-Type Contactors



Features

- One, two and four pole models
- Snap mount directly to front or side of contactor.

Auxiliary Contact Data

Arrangements: 1 Form A (SPST-NO), 1 Form B (SPST-NC), 1 Form A + 1 Form B (SPST-NO + SPST-NC), 2 Form A (DPST-NO), 2 Form B (DPST-NC), 2 Form A + 2 Form B (DPST-NO + DPST-NC), 4 Form A (4PST-NO), 4 Form B (4PST-NC), 3 Form A + 1 Form B (3PST-NO + SPST-NC).

Material: Cu-AgNi 90/10.

Maximum Rated Load: AC-15, 360VA; DC-13, 33W.

Rated Operating Voltage (U_r): AC, 380V; DC, 220V.

Rated Insulation Voltage (U_i): 690V.

Minimum Making Load: 24V - 10mA.

Conventional Thermal Current: 10A.

Electrical Specifications

Insulation Resistance: 10 megohms.

Electrical Life: 1,200,000 cycles (2400 cycles/hr).

Mechanical Specifications

Termination: Finger safe (IP 20) screw clamps.

Mounting: Mount directly to contactor.

Mechanical Life: 10,000,000 cycles (2400 cycles/hr).

Environmental Data

Temperature Range:

Operating: -5°C to +40°C at RH of 50% or less. Higher humidity is permissible at lower temperatures.

Storage: -25°C to +55°C

Maximum Altitude: 2000m

Pollution Class: 3

Vibration: 2-13.2 Hz, ±1mm

Shock Resistance: 13.2-100 Hz, ±7m/s²

Ordering Information

Part Number	Number of Auxiliary Contact Sets		Mounting Location	For Use on These PBC- Contactors...
	NO	NC		
PBA-01A	0	1	Front	025 - 080 (not 009, 012, 018)
PBA-10A	1	0	Front	025 - 080 (not 009, 012, 018)
PBA-11A	1	1	Front	009 - 080 (all models)
PBA-02A	0	2	Front	009 - 080 (all models)
PBA-20A	2	0	Front	009 - 080 (all models)
PBA-22A	2	2	Front	009 - 080 (all models)
PBA-31A	3	1	Front	009 - 080 (all models)
PBA-13A	1	3	Front	009 - 080 (all models)
PBA-40A	4	0	Front	009 - 080 (all models)
PBA-04A	0	4	Front	009 - 080 (all models)
PBA-11B	1	1	Side	009 - 080 (all models)
PBA-20B	2	0	Side	009 - 080 (all models)

NOTE: All models are RoHS compliant.

Outline Dimensions & Wiring Diagrams

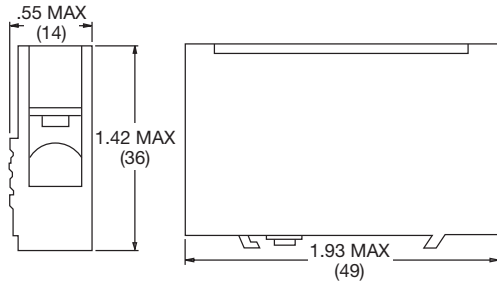

PBA-01A & PBA-10A Front Mount Auxiliary Contact Blocks

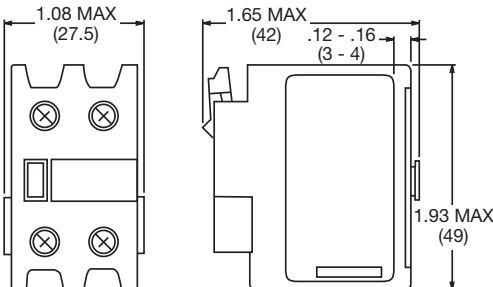

PBA-11A, PBA-02A & PBA-20A Front Mount Auxiliary Contact Blocks

Outline Dimensions & Wiring Diagrams

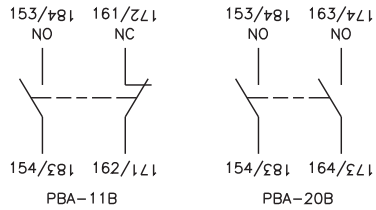
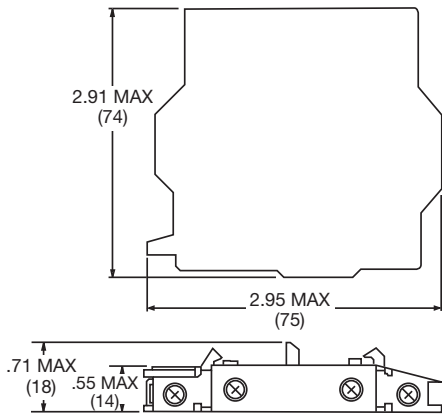

PBA-11B & PBA-20B Side Mount Auxiliary Contact Blocks

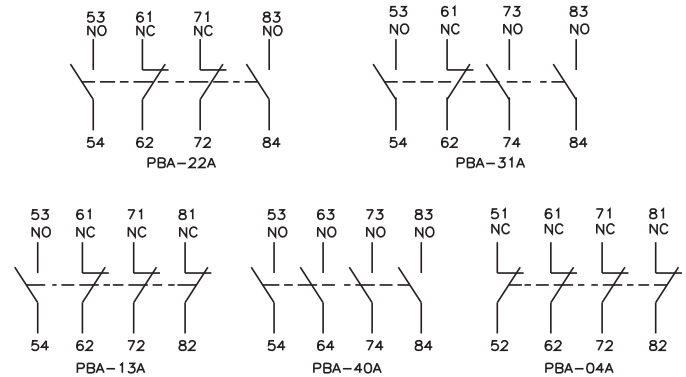
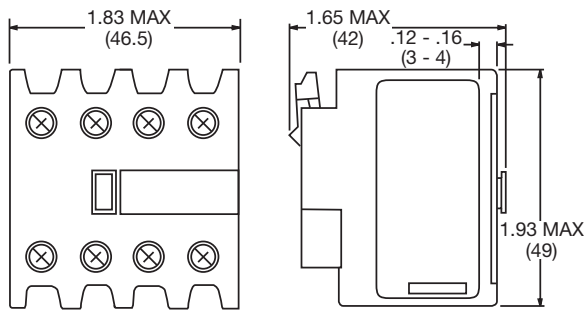

PBA-22A, PBA-31A, PBA-13A, PBA-40A & PBA-04A Front Mount Auxiliary Contact Blocks

Mounting Diagrams

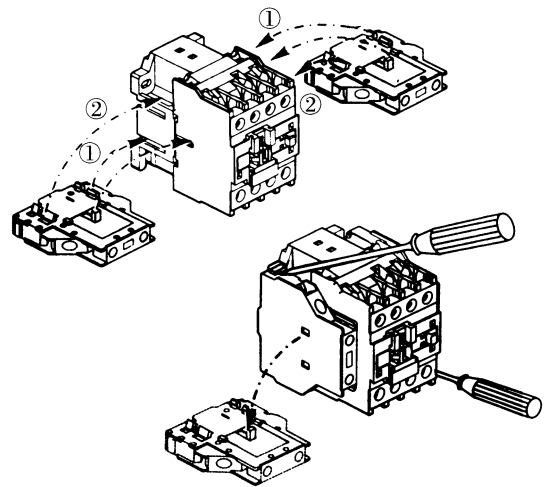
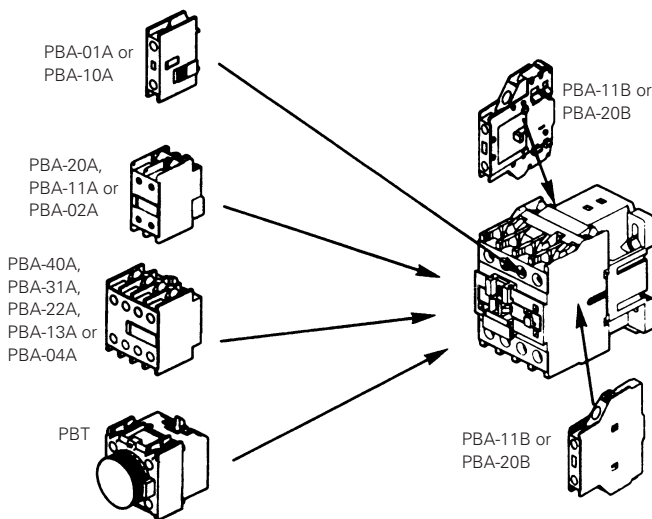

NOTE: PBC contactors of different sizes will physically accommodate varying numbers of auxiliary contact blocks; however, no more than two blocks of auxiliary contacts (timed or non-timed) should be used with any PBC contactor at a given time.

NOTE: PBA auxiliary contact blocks are designed to snap onto PBC series contactors without the use of tools. A screwdriver or similar tool may be useful in removing side-mount versions of the PBA.



PBT series

Pneumatic Timer Blocks for use with PBC series IEC-Type Contactors



Features

- Delay on make or delay on break models
- Snap mount directly to front of contactor.

Auxiliary Contact Data

Arrangement: 1 Form A + 1 Form B (SPST-NO + SPST-NC).
Material: Cu-AgNi 90/10.
Maximum Rated Load: AC-15, 360VA; DC-13, 33W.
Rated Operating Voltage (U_i): AC, 380V; DC, 220V.
Rated Insulation Voltage (U_i): 690V.
Minimum Making Load: 24V - 10mA.
Conventional Thermal Current: 10A.

Timing Specifications

Time Delay Repetitive Error: ±5%.
Time Delay Stability Error: ±15%.
Time Delay Temperature Error: ±0.3%.

Electrical Specifications

Insulation Resistance: 10 megohms.
Electrical Life: 500,000 cycles (1200 cycles/hr).

Mechanical Specifications

Termination: Finger safe (IP 20) screw clamps.
Mounting: Mount directly to contactor.
Mechanical Life: 3,000,000 cycles (1200 cycles/hr).

Outline Dimensions

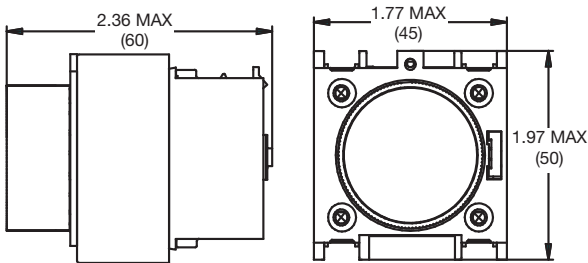

Wiring Diagrams

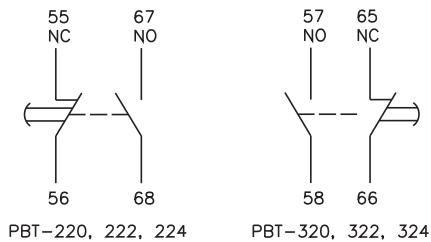

Environmental Data

Temperature Range:
Operating: -5°C to +40°C at RH of 50% or less. Higher humidity is permissible at lower temperatures.
Storage: -25°C to +55°C
Maximum Altitude: 2000m
Pollution Class: 3
Vibration: 2-13.2 Hz, ±1mm
Shock Resistance: 13.2-100 Hz, ±7m/s²

Ordering Information

Part Number	Number of Auxiliary Contact Sets		Delay Range Seconds	Delay Method (Timing Function)
	NO	NC		
PBT-220	1	1	0.1 - 3.0	Delay on Make
PBT-222	1	1	0.1 - 30.0	Delay on Make
PBT-224	1	1	10.0 - 30.0	Delay on Make
PBT-320	1	1	0.1 - 3.0	Delay on Break
PBT-322	1	1	0.1 - 30.0	Delay on Break
PBT-324	1	1	10.0 - 30.0	Delay on Break

NOTE: All PBT models may be used with any PBC series contactor. All models are RoHS compliant.

Mounting Diagrams

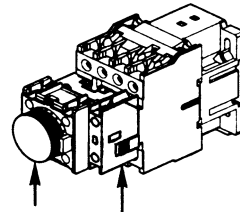

PBT PBA-01A or PBA-10A may also be mounted to some PBC models along with the PBT. Other PBC models will only accept the side-mount PBA-11B or PBA-20B when the PBT is used.

