

PRODUCT NUMBER
SEE TABLE

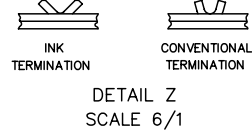
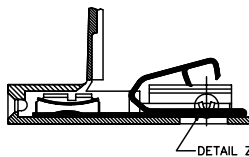
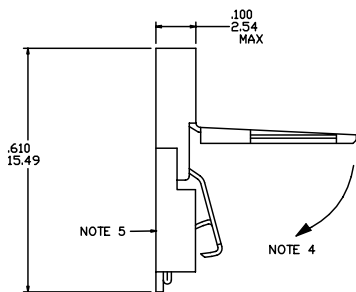
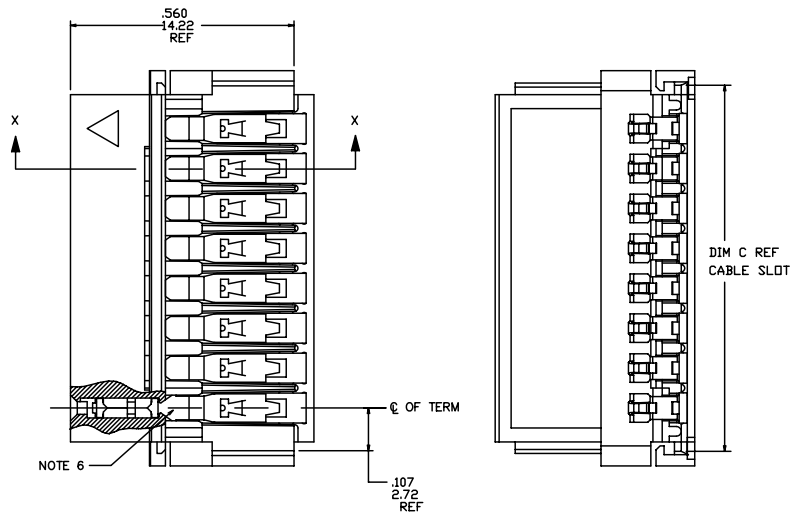
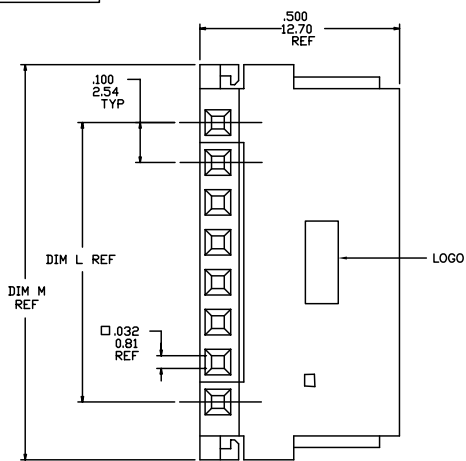

| | | | | | |
|------------|----------|---------|-----------|-------------------------------|----------------|
| mat'l code | | surface | tolerance | projection | product family |
| ISO 1902 | | ISO 406 | ISO 1101 | ISO 10 | CLINCHER |
| itr | ecm no | dr | date | title | |
| AF | V50167 | HTB | 1/19/95 | CLINCHER™ RECEPTACLE ASSEMBLY | |
| AG | V50220 | HTB | 2/7/95 | scale 3:1 | |
| AH | V60509 | HTB | 3/5/96 | sheet 1 of 7 size | |
| AJ | M05-0087 | MHT | 6/15/05 | 65801 A3 | |
| AK | M06-0233 | AGS | 6/12/06 | type Product Customer Drawing | |
| AL | M07-0088 | MHT | 2/06/07 | | |
| AM | M09-0062 | CMR | 4/09/09 | | |
| sheet | revision | AM | AM | AM | AM |
| index | sheet | 1 | 2 | 3 | 4 |

PDM: Rev:AM

STATUS: Released

Printed: Jul 22, 2010

| PLATING AVAILABLE | | | |
|-------------------|--|--|--|
| PLATING CODE | TERMINAL | SPRING | |
| 1 | 100u"/2.54u MIN. THICK PURE TIN | 10u"/.25u MIN. THICK PURE TIN | |
| 2 | 30u"/.76u MIN. GOLD STRIPE IN BOX AREA | 3u"/.08u MIN. GOLD OVER 50u"/1.27u MIN. NICKLE | |

PRODUCT NUMBER
65801-XXXLF

LEAD FREE OPTION
NOTE 9,10

NO OF POSITIONS
AND PLATING

BASE PART NUMBER

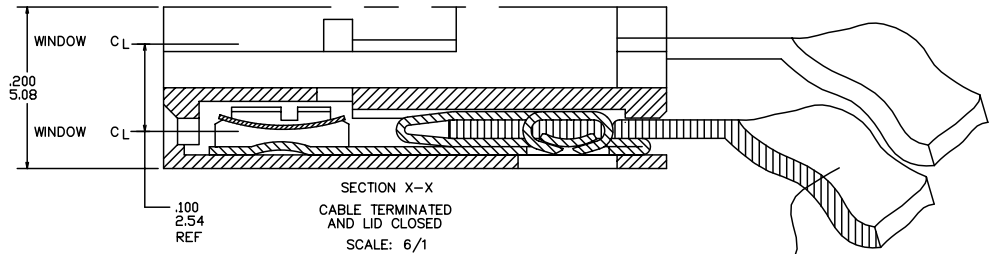

NOTES:

- ① MOLDING MAT'L: POLYPROPYLENE, FLAME RETARDENT PER UL 94V-0. COLOR: BLUE.
- ② TERMINAL MAT'L: 1/2 HARD CuNi ALLOY, UNS-C72500. PLATING: SEE TABULATION AND PLATING TABLE.
- ③ SPRING MAT'L: 1/2 HARD BeCu ALLOY, UNS-C17200. PLATING: SEE TABULATION AND PLATING TABLE.
- ④ LATCH SWINGS CLOSED AFTER TERMINATION MAINTAINING A MAX OVER ALL HEIGHT OF .100/2.54
- ⑤ LABEL IN THIS AREA P/N AND DATE LOT CODE (WEEK AND YEAR) ON DASH No.-067 AND -167 ONLY.
- ⑥ KNURL MARK INDICATES FOR USE WITH INK TERMINATION. CONSULT WITH BERG ELECTRONICS TECHNICAL REPRESENTATIVE FOR SPECIFIC APPLICATIONS.
- ⑦ POSITION NUMBERS INITIATE FROM TRIANGULAR MARK ON HOUSING. SEE TABULATION FOR POSITION No CLOSED AND TERMINAL No ABSENT. FIG A SHOWS POSITION No 2 CLOSED.
- ⑧ AN EIGHT DIGIT PART NUMBER FOLLOWED BY A "J" INDICATES INVENTORY FOR JAPAN ONLY.
- ⑨ ADD "LF" SUFFIX AT THE END OF PART NUMBER FOR LEAD FREE OPTION.
- ⑩ THIS PRODUCT MEETS EUROPEAN UNION DIRECTIVES AND OTHER COUNTRY REGULATION AS DESCRIBED IN GS-22-008.
- 11 THE PRODUCT IS NOT INTENDED TO BE EXPOSED TO A MANUFACTURING SOLDER PROCESS

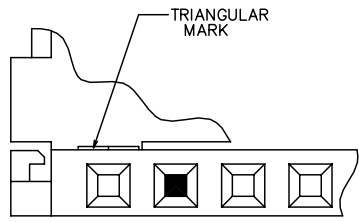

FIG A
NOTE 7

| | | | | |
|-------------|----------------|---------------------------------------|------------|-------------------------------|
| mat'l code | surface | tolerance | projection | product family |
| itr | ISO 1902 | ISO 406 | ASME | CLINCHER |
| ecm no | date | ISO 1101 | INCH/MM | title |
| AM | | tolerances unless otherwise specified | scale 3:1 | CLINCHER™ RECEPTACLE ASSEMBLY |
| | angles | linear | | dwg no |
| | 0°±2° | .XX±.01/.3 | | 65801 |
| | | .XXX±.005/.13 | | sheet 2 of 7 |
| | dr | .000±.0020/.051 | | size |
| | enrg | | | A3 |
| | chr | | | type |
| | appd | | | Product Customer Drawing |
| sheet index | revision sheet | | | |

| PRODUCT NO. NOTE 9 | NO. OF POSITIONS | DIM. L | | DIM. M | | DIM. C | | PLATING CODE | TERMINATION NOTE 6 | NOTES | |
|-----------------------|---------------------|---------------------|--------|---------|--------|---------|--------|-----------------|-----------------------|--------|--|
| | | ENGLISH | METRIC | ENGLISH | METRIC | ENGLISH | METRIC | | | | |
| 65801-001 | | U N A S S I G N E D | | | | | | | | | |
| 65801-002 | 2 | 0.100 | 2.54 | 0.390 | 9.91 | 0.315 | 8.00 | 1 | CONVENTIONAL | - | |
| 65801-003 | 3 | 0.200 | 5.08 | 0.490 | 12.45 | 0.415 | 10.54 | 1 | CONVENTIONAL | - | |
| 65801-004 | 4 | 0.300 | 7.62 | 0.590 | 14.99 | 0.515 | 13.08 | 1 | CONVENTIONAL | - | |
| 65801-005 | 5 | 0.400 | 10.16 | 0.690 | 17.53 | 0.615 | 15.62 | 1 | CONVENTIONAL | - | |
| 65801-006 | 6 | 0.500 | 12.70 | 0.790 | 20.07 | 0.715 | 18.16 | 1 | CONVENTIONAL | - | |
| 65801-007 | 7 | 0.600 | 15.24 | 0.890 | 22.61 | 0.815 | 20.70 | 1 | CONVENTIONAL | - | |
| 65801-008 | 8 | 0.700 | 17.78 | 0.990 | 25.15 | 0.915 | 23.24 | 1 | CONVENTIONAL | - | |
| 65801-009 | 9 | 0.800 | 20.32 | 1.090 | 27.69 | 1.015 | 25.78 | 1 | CONVENTIONAL | - | |
| 65801-010 | 10 | 0.900 | 22.86 | 1.190 | 30.23 | 1.115 | 28.32 | 1 | CONVENTIONAL | - | |
| 65801-011 | 11 | 1.000 | 25.40 | 1.290 | 32.77 | 1.215 | 30.86 | 1 | CONVENTIONAL | - | |
| 65801-012 | 12 | 1.100 | 27.94 | 1.390 | 35.31 | 1.315 | 33.40 | 1 | CONVENTIONAL | - | |
| 65801-013 | 13 | 1.200 | 30.48 | 1.490 | 37.85 | 1.415 | 35.94 | 1 | CONVENTIONAL | - | |
| 65801-014 | 14 | 1.300 | 33.02 | 1.590 | 40.39 | 1.515 | 38.48 | 1 | CONVENTIONAL | - | |
| 65801-015 | 15 | 1.400 | 35.56 | 1.690 | 42.93 | 1.615 | 41.02 | 1 | CONVENTIONAL | - | |
| 65801-016 | 16 | 1.500 | 38.10 | 1.790 | 45.47 | 1.715 | 43.56 | 1 | CONVENTIONAL | - | |
| 65801-017 | 17 | 1.600 | 40.64 | 1.890 | 48.01 | 1.815 | 46.10 | 1 | CONVENTIONAL | NOTE 8 | |
| 65801-018 | 18 | 1.700 | 43.18 | 1.990 | 50.55 | 1.915 | 48.64 | 1 | CONVENTIONAL | - | |
| 65801-019 | 19 | 1.800 | 45.72 | 2.090 | 53.09 | 2.015 | 51.18 | 1 | CONVENTIONAL | - | |
| 65801-020 | 20 | 1.900 | 48.26 | 2.190 | 55.63 | 2.115 | 53.72 | 1 | CONVENTIONAL | - | |
| 65801-021 | 21 | 2.000 | 50.80 | 2.290 | 58.17 | 2.215 | 56.26 | 1 | CONVENTIONAL | - | |
| 65801-022 | 22 | 2.100 | 53.34 | 2.390 | 60.71 | 2.315 | 58.80 | 1 | CONVENTIONAL | - | |
| 65801-023 | 23 | 2.200 | 55.88 | 2.490 | 63.25 | 2.415 | 61.34 | 1 | CONVENTIONAL | - | |
| 65801-024 | 24 | 2.300 | 58.42 | 2.590 | 65.79 | 2.515 | 63.88 | 1 | CONVENTIONAL | - | |
| 65801-025 | 25 | 2.400 | 60.96 | 2.690 | 68.33 | 2.615 | 66.42 | 1 | CONVENTIONAL | - | |
| 65801-026 | 26 | 2.500 | 63.50 | 2.790 | 70.87 | 2.715 | 68.96 | 1 | CONVENTIONAL | - | |
| 65801-027 | 27 | 2.600 | 66.04 | 2.890 | 73.41 | 2.815 | 71.50 | 1 | CONVENTIONAL | - | |
| 65801-028 | 28 | 2.700 | 68.58 | 2.990 | 75.95 | 2.915 | 74.04 | 1 | CONVENTIONAL | - | |
| 65801-029 | 29 | 2.800 | 71.12 | 3.090 | 78.49 | 3.015 | 76.58 | 1 | CONVENTIONAL | - | |
| 65801-030 | 30 | 2.900 | 73.66 | 3.190 | 81.03 | 3.115 | 79.12 | 1 | CONVENTIONAL | - | |
| 65801-031 | 31 | 3.000 | 76.20 | 3.290 | 83.57 | 3.215 | 81.66 | 1 | CONVENTIONAL | - | |
| 65801-032 | 32 | 3.100 | 78.74 | 3.390 | 86.11 | 3.315 | 84.20 | 1 | CONVENTIONAL | - | |

| | | | | |
|-------------|---------------------|----------------------------------|----------------|---|
| mat'l code | surface ISO 1902 | tolerance ISO 406 ISO 1101 | projection | product family CLINCHER |
| itr | ecrn no | dr | date | title CLINCHER™ RECEPTACLE ASSEMBLY |
| AM | | | | dwg no 65801 |
| | | | | sheet 3 of 7 |
| | | | | size A3 |
| | | | | type Product Customer Drawing |
| sheet index | revision sheet | | | |

PDM: Rev:AM STATUS: Released Printed: Jul 22, 2010

FCJ
FCJconnect.com
Copyright FCJ

| PRODUCT NO. NOTE 9 | NO. OF POSITIONS | DIM. L | | DIM. M | | DIM. C | | PLATING CODE | TERMINATION NOTE 6 | NOTES |
|-----------------------|---------------------|---------|--------|---------|--------|---------|--------|-----------------|-----------------------|--------|
| | | ENGLISH | METRIC | ENGLISH | METRIC | ENGLISH | METRIC | | | |
| 65801-033 | 4 | 0.300 | 7.62 | 0.590 | 14.99 | 0.515 | 13.08 | 2 | CONVENTIONAL | - |
| 65801-034 | 5 | 0.400 | 10.16 | 0.690 | 17.53 | 0.615 | 15.62 | 2 | CONVENTIONAL | - |
| 65801-035 | 6 | 0.500 | 12.70 | 0.790 | 20.07 | 0.715 | 18.16 | 2 | CONVENTIONAL | - |
| 65801-036 | 7 | 0.600 | 15.24 | 0.890 | 22.61 | 0.815 | 20.70 | 2 | CONVENTIONAL | - |
| 65801-037 | 8 | 0.700 | 17.78 | 0.990 | 25.15 | 0.915 | 23.24 | 2 | CONVENTIONAL | - |
| 65801-038 | 9 | 0.800 | 20.32 | 1.090 | 27.69 | 1.015 | 25.78 | 2 | CONVENTIONAL | - |
| 65801-039 | 10 | 0.900 | 22.86 | 1.190 | 30.23 | 1.115 | 28.32 | 2 | CONVENTIONAL | - |
| 65801-040 | 11 | 1.000 | 25.40 | 1.290 | 32.77 | 1.215 | 30.86 | 2 | CONVENTIONAL | - |
| 65801-041 | 12 | 1.100 | 27.94 | 1.390 | 35.31 | 1.315 | 33.40 | 2 | CONVENTIONAL | - |
| 65801-042 | 13 | 1.200 | 30.48 | 1.490 | 37.85 | 1.415 | 35.94 | 2 | CONVENTIONAL | - |
| 65801-043 | 14 | 1.300 | 33.02 | 1.590 | 40.39 | 1.515 | 38.48 | 2 | CONVENTIONAL | - |
| 65801-044 | 15 | 1.400 | 35.56 | 1.690 | 42.93 | 1.615 | 41.02 | 2 | CONVENTIONAL | - |
| 65801-045 | 16 | 1.500 | 38.10 | 1.790 | 45.47 | 1.715 | 43.56 | 2 | CONVENTIONAL | - |
| 65801-046 | 17 | 1.600 | 40.64 | 1.890 | 48.01 | 1.815 | 46.10 | 2 | CONVENTIONAL | - |
| 65801-047 | 18 | 1.700 | 43.18 | 1.990 | 50.55 | 1.915 | 48.64 | 2 | CONVENTIONAL | - |
| 65801-048 | 19 | 1.800 | 45.72 | 2.090 | 53.09 | 2.015 | 51.18 | 2 | CONVENTIONAL | - |
| 65801-049 | 20 | 1.900 | 48.26 | 2.190 | 55.63 | 2.115 | 53.72 | 2 | CONVENTIONAL | - |
| 65801-050 | 21 | 2.000 | 50.80 | 2.290 | 58.17 | 2.215 | 56.26 | 2 | CONVENTIONAL | - |
| 65801-051 | 22 | 2.100 | 53.34 | 2.390 | 60.71 | 2.315 | 58.80 | 2 | CONVENTIONAL | - |
| 65801-052 | 23 | 2.200 | 55.88 | 2.490 | 63.25 | 2.415 | 61.34 | 2 | CONVENTIONAL | - |
| 65801-053 | 24 | 2.300 | 58.42 | 2.590 | 65.79 | 2.515 | 63.88 | 2 | CONVENTIONAL | - |
| 65801-054 | 25 | 2.400 | 60.96 | 2.690 | 68.33 | 2.615 | 66.42 | 2 | CONVENTIONAL | - |
| 65801-055 | 26 | 2.500 | 63.50 | 2.790 | 70.87 | 2.715 | 68.96 | 2 | CONVENTIONAL | - |
| 65801-056 | 27 | 2.600 | 66.04 | 2.890 | 73.41 | 2.815 | 71.50 | 2 | CONVENTIONAL | - |
| 65801-057 | 28 | 2.700 | 68.58 | 2.990 | 75.95 | 2.915 | 74.04 | 2 | CONVENTIONAL | - |
| 65801-058 | 29 | 2.800 | 71.12 | 3.090 | 78.49 | 3.015 | 76.58 | 2 | CONVENTIONAL | - |
| 65801-059 | 30 | 2.900 | 73.66 | 3.190 | 81.03 | 3.115 | 79.12 | 2 | CONVENTIONAL | - |
| 65801-060 | 31 | 3.000 | 76.20 | 3.290 | 83.57 | 3.215 | 81.66 | 2 | CONVENTIONAL | - |
| 65801-061 | 32 | 3.100 | 78.74 | 3.390 | 86.11 | 3.315 | 84.20 | 2 | CONVENTIONAL | - |
| 65801-062 | 3 | 0.200 | 5.08 | 0.490 | 12.45 | 0.415 | 10.54 | 2 | CONVENTIONAL | - |
| 65801-063 | 2 | 0.100 | 2.54 | 0.390 | 9.91 | 0.315 | 8.00 | 2 | CONVENTIONAL | - |
| 65801-064 | 34 | 3.300 | 83.82 | 3.590 | 91.19 | 3.515 | 89.28 | 1 | CONVENTIONAL | - |
| 65801-065 | 33 | 3.200 | 81.28 | 3.490 | 88.65 | 3.415 | 86.74 | 1 | CONVENTIONAL | - |
| 65801-066 | 34 | 3.300 | 83.82 | 3.590 | 91.19 | 3.515 | 89.28 | 2 | CONVENTIONAL | - |
| 65801-067 | 12 | 1.100 | 27.94 | 1.390 | 35.31 | 1.315 | 33.40 | 2 | CONVENTIONAL | NOTE 5 |



Copyright FCI

| | | | | |
|-------------|---------------------|----------------------------------|------------|---|
| mat'l code | surface ISO 1902 | tolerance ISO 406 ISO 1101 | projection | product family CLINCHER |
| itr | ecrn no | dr | date | title CLINCHER™ RECEPTACLE ASSEMBLY |
| AM | | | | dwg no 65801 |
| | angles | linear | scale 3:1 | sheet 4 of 7 size A3 |
| | 0°±2' | | | type Product Customer Drawing |
| | dr | T.BREWBAKER | 5/17/94 | |
| | engr | T. HANNA | 5/17/94 | |
| | chr | J. MURPHY | 5/17/94 | |
| | appd | T. HANNA | 5/17/94 | |
| sheet index | revision sheet | | | |

| PRODUCT NO. NOTE 9 | NO. OF POSITIONS | DIM. L | | DIM. M | | DIM. C | | PLATING CODE | TERMINATION NOTE 6 | NOTES |
|-----------------------|---------------------|---------|--------|---------|--------|---------|--------|-----------------|-----------------------|-------|
| | | ENGLISH | METRIC | ENGLISH | METRIC | ENGLISH | METRIC | | | |
| 65801-102 | 2 | 0.100 | 2.54 | 0.390 | 9.91 | 0.315 | 8.00 | 1 | INK | - |
| 65801-103 | 3 | 0.200 | 5.08 | 0.490 | 12.45 | 0.415 | 10.54 | 1 | INK | - |
| 65801-104 | 4 | 0.300 | 7.62 | 0.590 | 14.99 | 0.515 | 13.08 | 1 | INK | - |
| 65801-105 | 5 | 0.400 | 10.16 | 0.690 | 17.53 | 0.615 | 15.62 | 1 | INK | - |
| 65801-106 | 6 | 0.500 | 12.70 | 0.790 | 20.07 | 0.715 | 18.16 | 1 | INK | - |
| 65801-107 | 7 | 0.600 | 15.24 | 0.890 | 22.61 | 0.815 | 20.70 | 1 | INK | - |
| 65801-108 | 8 | 0.700 | 17.78 | 0.990 | 25.15 | 0.915 | 23.24 | 1 | INK | - |
| 65801-109 | 9 | 0.800 | 20.32 | 1.090 | 27.69 | 1.015 | 25.78 | 1 | INK | - |
| 65801-110 | 10 | 0.900 | 22.86 | 1.190 | 30.23 | 1.115 | 28.32 | 1 | INK | - |
| 65801-111 | 11 | 1.000 | 25.40 | 1.290 | 32.77 | 1.215 | 30.86 | 1 | INK | - |
| 65801-112 | 12 | 1.100 | 27.94 | 1.390 | 35.31 | 1.315 | 33.40 | 1 | INK | - |
| 65801-113 | 13 | 1.200 | 30.48 | 1.490 | 37.85 | 1.415 | 35.94 | 1 | INK | - |
| 65801-114 | 14 | 1.300 | 33.02 | 1.590 | 40.39 | 1.515 | 38.48 | 1 | INK | - |
| 65801-115 | 15 | 1.400 | 35.56 | 1.690 | 42.93 | 1.615 | 41.02 | 1 | INK | - |
| 65801-116 | 16 | 1.500 | 38.10 | 1.790 | 45.47 | 1.715 | 43.56 | 1 | INK | - |
| 65801-117 | 17 | 1.600 | 40.64 | 1.890 | 48.01 | 1.815 | 46.10 | 1 | INK | - |
| 65801-118 | 18 | 1.700 | 43.18 | 1.990 | 50.55 | 1.915 | 48.64 | 1 | INK | - |
| 65801-119 | 19 | 1.800 | 45.72 | 2.090 | 53.09 | 2.015 | 51.18 | 1 | INK | - |
| 65801-120 | 20 | 1.900 | 48.26 | 2.190 | 55.63 | 2.115 | 53.72 | 1 | INK | - |
| 65801-121 | 21 | 2.000 | 50.80 | 2.290 | 58.17 | 2.215 | 56.26 | 1 | INK | - |
| 65801-122 | 22 | 2.100 | 53.34 | 2.390 | 60.71 | 2.315 | 58.80 | 1 | INK | - |
| 65801-123 | 23 | 2.200 | 55.88 | 2.490 | 63.25 | 2.415 | 61.34 | 1 | INK | - |
| 65801-124 | 24 | 2.300 | 58.42 | 2.590 | 65.79 | 2.515 | 63.88 | 1 | INK | - |
| 65801-125 | 25 | 2.400 | 60.96 | 2.690 | 68.33 | 2.615 | 66.42 | 1 | INK | - |
| 65801-126 | 26 | 2.500 | 63.50 | 2.790 | 70.87 | 2.715 | 68.96 | 1 | INK | - |
| 65801-127 | 27 | 2.600 | 66.04 | 2.890 | 73.41 | 2.815 | 71.50 | 1 | INK | - |
| 65801-128 | 28 | 2.700 | 68.58 | 2.990 | 75.95 | 2.915 | 74.04 | 1 | INK | - |
| 65801-129 | 29 | 2.800 | 71.12 | 3.090 | 78.49 | 3.015 | 76.58 | 1 | INK | - |
| 65801-130 | 30 | 2.900 | 73.66 | 3.190 | 81.03 | 3.115 | 79.12 | 1 | INK | - |
| 65801-131 | 31 | 3.000 | 76.20 | 3.290 | 83.57 | 3.215 | 81.66 | 1 | INK | - |
| 65801-132 | 32 | 3.100 | 78.74 | 3.390 | 86.11 | 3.315 | 84.20 | 1 | INK | - |

| | | | | |
|-------------|---------------------|----------------------------------|------------|----------------------------------|
| mat'l code | surface ISO 1902 | tolerance ISO 406 ISO 1101 | projection | product family |
| itr | ecm no | dr | date | CLINCHER |
| AM | | | | title |
| | | | | CLINCHER™ RECEPTACLE ASSEMBLY |
| | | | | dwg no |
| | | | | 65801 |
| | | | | sheet 5 of 7 |
| | | | | size |
| | | | | A3 |
| | | | | type |
| | | | | Product Customer Drawing |
| sheet index | revision | sheet | | |

PDM: Rev:AM STATUS:Released Printed: Jul 22, 2010

| PRODUCT NO. NOTE 9 | NO. OF POSITIONS | DIM. L | | DIM. M | | DIM. C | | PLATING CODE | TERMINATION NOTE 6 | NOTES | |
|-----------------------|---------------------|---------|--------|------------|--------|---------|--------|-----------------|-----------------------|--------|--|
| | | ENGLISH | METRIC | ENGLISH | METRIC | ENGLISH | METRIC | | | | |
| 65801-133 | 4 | 0.300 | 7.62 | 0.590 | 14.99 | 0.515 | 13.08 | 2 | INK | - | |
| 65801-134 | 5 | 0.400 | 10.16 | 0.690 | 17.53 | 0.615 | 15.62 | 2 | INK | - | |
| 65801-135 | 6 | 0.500 | 12.70 | 0.790 | 20.07 | 0.715 | 18.16 | 2 | INK | - | |
| 65801-136 | 7 | 0.600 | 15.24 | 0.890 | 22.61 | 0.815 | 20.70 | 2 | INK | - | |
| 65801-137 | 8 | 0.700 | 17.78 | 0.990 | 25.15 | 0.915 | 23.24 | 2 | INK | - | |
| 65801-138 | 9 | 0.800 | 20.32 | 1.090 | 27.69 | 1.015 | 25.78 | 2 | INK | - | |
| 65801-139 | 10 | 0.900 | 22.86 | 1.190 | 30.23 | 1.115 | 28.32 | 2 | INK | - | |
| 65801-140 | 11 | 1.000 | 25.40 | 1.290 | 32.77 | 1.215 | 30.86 | 2 | INK | - | |
| 65801-141 | 12 | 1.100 | 27.94 | 1.390 | 35.31 | 1.315 | 33.40 | 2 | INK | - | |
| 65801-142 | 13 | 1.200 | 30.48 | 1.490 | 37.85 | 1.415 | 35.94 | 2 | INK | - | |
| 65801-143 | 14 | 1.300 | 33.02 | 1.590 | 40.39 | 1.515 | 38.48 | 2 | INK | - | |
| 65801-144 | 15 | 1.400 | 35.56 | 1.690 | 42.93 | 1.615 | 41.02 | 2 | INK | - | |
| 65801-145 | 16 | 1.500 | 38.10 | 1.790 | 45.47 | 1.715 | 43.56 | 2 | INK | - | |
| 65801-146 | 17 | 1.600 | 40.64 | 1.890 | 48.01 | 1.815 | 46.10 | 2 | INK | - | |
| 65801-147 | 18 | 1.700 | 43.18 | 1.990 | 50.55 | 1.915 | 48.64 | 2 | INK | - | |
| 65801-148 | 19 | 1.800 | 45.72 | 2.090 | 53.09 | 2.015 | 51.18 | 2 | INK | - | |
| 65801-149 | 20 | 1.900 | 48.26 | 2.190 | 55.63 | 2.115 | 53.72 | 2 | INK | - | |
| 65801-150 | 21 | 2.000 | 50.80 | 2.290 | 58.17 | 2.215 | 56.26 | 2 | INK | - | |
| 65801-151 | 22 | 2.100 | 53.34 | 2.390 | 60.71 | 2.315 | 58.80 | 2 | INK | - | |
| 65801-152 | 23 | 2.200 | 55.88 | 2.490 | 63.25 | 2.415 | 61.34 | 2 | INK | - | |
| 65801-153 | 24 | 2.300 | 58.42 | 2.590 | 65.79 | 2.515 | 63.88 | 2 | INK | - | |
| 65801-154 | 25 | 2.400 | 60.96 | 2.690 | 68.33 | 2.615 | 66.42 | 2 | INK | - | |
| 65801-155 | 26 | 2.500 | 63.50 | 2.790 | 70.87 | 2.715 | 68.96 | 2 | INK | - | |
| 65801-156 | 27 | 2.600 | 66.04 | 2.890 | 73.41 | 2.815 | 71.50 | 2 | INK | - | |
| 65801-157 | 28 | 2.700 | 68.58 | 2.990 | 75.95 | 2.915 | 74.04 | 2 | INK | - | |
| 65801-158 | 29 | 2.800 | 71.12 | 3.090 | 78.49 | 3.015 | 76.58 | 2 | INK | - | |
| 65801-159 | 30 | 2.900 | 73.66 | 3.190 | 81.03 | 3.115 | 79.12 | 2 | INK | - | |
| 65801-160 | 31 | 3.000 | 76.20 | 3.290 | 83.57 | 3.215 | 81.66 | 2 | INK | - | |
| 65801-161 | 32 | 3.100 | 78.74 | 3.390 | 86.11 | 3.315 | 84.20 | 2 | INK | - | |
| 65801-162 | 3 | 0.200 | 5.08 | 0.490 | 12.45 | 0.415 | 10.54 | 2 | INK | - | |
| 65801-163 | 2 | 0.100 | 2.54 | 0.390 | 9.91 | 0.315 | 8.00 | 2 | INK | - | |
| 65801-164 | | | | UNASSIGNED | | | | | | | |
| 65801-165 | | | | UNASSIGNED | | | | | | | |
| 65801-166 | 34 | 3.300 | 83.82 | 3.590 | 91.19 | 3.515 | 89.28 | 2 | INK | - | |
| 65801-167 | 12 | 1.100 | 27.94 | 1.390 | 35.31 | 1.315 | 33.40 | 2 | INK | NOTE 5 | |

| | | | | |
|-------------|---------------------|----------------------------------|------------|---|
| mat'l code | surface ISO 1802 | tolerance ISO 406 ISO 1101 | projection | product family CLINCHER |
| itr | ecm no | dr | date | title CLINCHER™ RECEPTACLE ASSEMBLY |
| AM | | | | dwg no 65801 |
| | | | | sheet 6 of 7 size A3 |
| | | | | type Product Customer Drawing |
| sheet index | revision sheet | | | |

| PRODUCT NO. NOTE 9 | NO. OF POSITIONS | DIM. L | | DIM. M | | DIM. C | | PLATING CODE | TERMINATION NOTE 6 | CLOSED POS. NOTE 7 | TERMINAL ABSENT NOTE 7 |
|-----------------------|---------------------|---------|--------|---------|--------|---------|--------|-----------------|-----------------------|-----------------------|---------------------------|
| | | ENGLISH | METRIC | ENGLISH | METRIC | ENGLISH | METRIC | | | | |
| 65801-201 | 16 | 1.500 | 38.10 | 1.790 | 45.47 | 1.715 | 43.56 | 1 | CONVENTIONAL | 4 | 4.5.6 |
| 65801-202 | 5 | 0.400 | 10.16 | 0.690 | 17.53 | 0.615 | 15.62 | 2 | CONVENTIONAL | 3 | 3 |
| 65801-203 | 7 | 0.600 | 15.24 | 0.890 | 22.61 | 0.815 | 20.70 | 2 | CONVENTIONAL | 6 | 1.2.6.7 |
| 65801-204 | 10 | 0.900 | 22.86 | 1.190 | 30.23 | 1.115 | 28.32 | 1 | CONVENTIONAL | 4 | 4 |
| 65801-205 | 6 | 0.500 | 12.70 | 0.790 | 20.07 | 0.715 | 18.16 | 1 | CONVENTIONAL | 5 | 5 |
| 65801-206 | 5 | 0.400 | 10.16 | 0.690 | 17.53 | 0.615 | 15.62 | 1 | CONVENTIONAL | 4 | 4 |
| 65801-207 | 7 | 0.600 | 15.24 | 0.890 | 22.61 | 0.815 | 20.70 | 2 | CONVENTIONAL | N/A | 1.2.6.7 |
| 65801-208 | 4 | 0.300 | 7.62 | 0.590 | 14.99 | 0.515 | 13.08 | 1 | CONVENTIONAL | N/A | 2.3 |
| 65801-209 | 3 | 0.200 | 5.08 | 0.490 | 12.45 | 0.415 | 10.54 | 1 | CONVENTIONAL | N/A | 2 |



Copyright FCI

| | | | | | | | | | |
|-------------|----------------|---------------------|-------------|---------------------------------------|--------|--|--|--|-----------|
| mat'l code | | surface ISO 1902 | | tolerance ISO 406 ISO 1101 | | projection | | product family CLINCHER | |
| itr | ecm no | dr | date | tolerances unless otherwise specified | | | | title CLINCHER™ RECEPTACLE ASSEMBLY | |
| AM | | | | angles | linear | .XX±.01/.3 .XXX±.005/.13 .000XX±.0020/.001 | | INCH/MM | scale 3:1 |
| | | | | 0°±2° | | | | | |
| | | dr | T.BREWBAKER | 5/17/94 | | | | FCI | |
| | | engr | T. HANNA | 5/17/94 | | | | dwg no 65801 sheet 7 of 7 size A3 | |
| | | chr | J.MURPHY | 5/17/94 | | | | type Product Customer Drawing | |
| | | appd | T. HANNA | 5/17/94 | | | | | |
| sheet index | revision sheet | | | | | | | | |