

Technische Information / technical information

IGBT-Module
IGBT-modules

BSM200GAL120DLC



62mm C-Serien Modul mit low loss IGBT2 und EmCon Diode
62mm C-series module with low loss IGBT2 and EmCon diode

IGBT-Wechselrichter / IGBT-inverter

Vorläufige Daten / preliminary data

Höchstzulässige Werte / maximum rated values

| | | | | |
|--|--|-----------------------|------------|--------|
| Kollektor-Emitter-Sperrspannung collector-emitter voltage | $T_{vj} = 25^{\circ}\text{C}$ | V_{CES} | 1200 | V |
| Kollektor-Dauergleichstrom DC-collector current | $T_C = 80^{\circ}\text{C}, T_{vj} = 150^{\circ}\text{C}$ $T_C = 25^{\circ}\text{C}, T_{vj} = 150^{\circ}\text{C}$ | $I_{C\ nom}$ I_C | 200 420 | A A |
| Periodischer Kollektor Spitzenstrom repetitive peak collector current | $t_P = 1\ \text{ms}$ | I_{CRM} | 400 | A |
| Gesamt-Verlustleistung total power dissipation | $T_C = 25^{\circ}\text{C}, T_{vj} = 150^{\circ}\text{C}$ | P_{tot} | 1400 | W |
| Gate-Emitter-Spitzenspannung gate-emitter peak voltage | | V_{GES} | +/-20 | V |

Charakteristische Werte / characteristic values

| | | | min. | typ. | max. | | |
|--|---|---|---------------|--------------|--------------|--------|--------------------------------|
| Kollektor-Emitter Sättigungsspannung collector-emitter saturation voltage | $I_C = 200\ \text{A}, V_{GE} = 15\ \text{V}$ $I_C = 200\ \text{A}, V_{GE} = 15\ \text{V}$ | $T_{vj} = 25^{\circ}\text{C}$ $T_{vj} = 125^{\circ}\text{C}$ | $V_{CE\ sat}$ | 2,10 2,40 | 2,60 2,90 | V V | |
| Gate-Schwellenspannung gate threshold voltage | $I_C = 8,00\ \text{mA}, V_{CE} = V_{GE}, T_{vj} = 25^{\circ}\text{C}$ | | V_{GEth} | 4,5 | 5,5 | 6,5 | V |
| Gateladung gate charge | $V_{GE} = -15\ \text{V} \dots +15\ \text{V}$ | | Q_G | 2,10 | | | μC |
| Interner Gatewiderstand internal gate resistor | $T_{vj} = 25^{\circ}\text{C}$ | | R_{Gint} | 2,5 | | | Ω |
| Eingangskapazität input capacitance | $f = 1\ \text{MHz}, T_{vj} = 25^{\circ}\text{C}, V_{CE} = 25\ \text{V}, V_{GE} = 0\ \text{V}$ | | C_{ies} | 13,0 | | | nF |
| Rückwirkungskapazität reverse transfer capacitance | $f = 1\ \text{MHz}, T_{vj} = 25^{\circ}\text{C}, V_{CE} = 25\ \text{V}, V_{GE} = 0\ \text{V}$ | | C_{res} | 0,85 | | | nF |
| Kollektor-Emitter Reststrom collector-emitter cut-off current | $V_{CE} = 1200\ \text{V}, V_{GE} = 0\ \text{V}, T_{vj} = 25^{\circ}\text{C}$ | | I_{CES} | | | 5,0 | mA |
| Gate-Emitter Reststrom gate-emitter leakage current | $V_{CE} = 0\ \text{V}, V_{GE} = 20\ \text{V}, T_{vj} = 25^{\circ}\text{C}$ | | I_{GES} | | | 400 | nA |
| Einschaltverzögerungszeit (ind. Last) turn-on delay time (inductive load) | $I_C = 200\ \text{A}, V_{CE} = 600\ \text{V}$ $V_{GE} = \pm 15\ \text{V}$ $R_{Gon} = 4,7\ \Omega$ | $T_{vj} = 25^{\circ}\text{C}$ $T_{vj} = 125^{\circ}\text{C}$ | $t_{d\ on}$ | 0,11 0,12 | | | μs μs |
| Anstiegszeit (induktive Last) rise time (inductive load) | $I_C = 200\ \text{A}, V_{CE} = 600\ \text{V}$ $V_{GE} = \pm 15\ \text{V}$ $R_{Gon} = 4,7\ \Omega$ | $T_{vj} = 25^{\circ}\text{C}$ $T_{vj} = 125^{\circ}\text{C}$ | t_r | 0,06 0,07 | | | μs μs |
| Abschaltverzögerungszeit (ind. Last) turn-off delay time (inductive load) | $I_C = 200\ \text{A}, V_{CE} = 600\ \text{V}$ $V_{GE} = \pm 15\ \text{V}$ $R_{Goff} = 4,7\ \Omega$ | $T_{vj} = 25^{\circ}\text{C}$ $T_{vj} = 125^{\circ}\text{C}$ | $t_{d\ off}$ | 0,55 0,57 | | | μs μs |
| Fallzeit (induktive Last) fall time (inductive load) | $I_C = 200\ \text{A}, V_{CE} = 600\ \text{V}$ $V_{GE} = \pm 15\ \text{V}$ $R_{Goff} = 4,7\ \Omega$ | $T_{vj} = 25^{\circ}\text{C}$ $T_{vj} = 125^{\circ}\text{C}$ | t_f | 0,07 0,08 | | | μs μs |
| Einschaltverlustenergie pro Puls turn-on energy loss per pulse | $I_C = 200\ \text{A}, V_{CE} = 600\ \text{V}$ $V_{GE} = \pm 15\ \text{V}, L_S = 60\ \text{nH}$ $R_{Gon} = 4,7\ \Omega$ | $T_{vj} = 25^{\circ}\text{C}$ $T_{vj} = 125^{\circ}\text{C}$ | E_{on} | 22,0 | | | mJ mJ |
| Abschaltverlustenergie pro Puls turn-off energy loss per pulse | $I_C = 200\ \text{A}, V_{CE} = 600\ \text{V}$ $V_{GE} = \pm 15\ \text{V}, L_S = 60\ \text{nH}$ $R_{Goff} = 4,7\ \Omega$ | $T_{vj} = 25^{\circ}\text{C}$ $T_{vj} = 125^{\circ}\text{C}$ | E_{off} | 23,0 | | | mJ mJ |
| Kurzschlußverhalten SC data | $t_P \leq 10\ \mu\text{s}, V_{GE} \leq 15\ \text{V}$ $T_{vj} = 125^{\circ}\text{C}, V_{CC} = 900\ \text{V}, V_{CEmax} = V_{CES} - L_{sCE} \cdot di/dt$ | | I_{SC} | 1300 | | | A |
| Innerer Wärmewiderstand thermal resistance, junction to case | pro IGBT per IGBT | | R_{thJC} | | | 0,09 | K/W |
| Übergangs-Wärmewiderstand thermal resistance, case to heatsink | pro IGBT / per IGBT $\lambda_{Paste} = 1\ \text{W}/(\text{m}\cdot\text{K}) / \lambda_{grease} = 1\ \text{W}/(\text{m}\cdot\text{K})$ | | R_{thCH} | | | 0,03 | K/W |

| | |
|-----------------------------|--------------------------------|
| prepared by: Martin Knecht | date of publication: 2004-6-28 |
| approved by: Wilhelm Rusche | revision: 2.0 |

Vorläufige Daten
preliminary data

Diode-Wechselrichter / diode-inverter

Höchstzulässige Werte / maximum rated values

| | | | | |
|---|--|-----------|------|----------------------|
| Periodische Spitzensperrspannung repetitive peak reverse voltage | $T_{vj} = 25^{\circ}\text{C}$ | V_{RRM} | 1200 | V |
| Dauergleichstrom DC forward current | | I_F | 200 | A |
| Periodischer Spitzenstrom repetitive peak forward current | $t_P = 1 \text{ ms}$ | I_{FRM} | 400 | A |
| Grenzlastintegral I^2t - value | $V_R = 0 \text{ V}, t_P = 10 \text{ ms}, T_{vj} = 125^{\circ}\text{C}$ | I^2t | 6900 | A^2s |

Charakteristische Werte / characteristic values

| | | | | min. | typ. | max. | |
|---|---|--------------------------------|------------|------|------|------|---------------|
| Durchlassspannung forward voltage | $I_F = 200 \text{ A}, V_{GE} = 0 \text{ V}$ | $T_{vj} = 25^{\circ}\text{C}$ | V_F | | 1,80 | 2,30 | V |
| | $I_F = 200 \text{ A}, V_{GE} = 0 \text{ V}$ | $T_{vj} = 125^{\circ}\text{C}$ | | | 1,70 | 2,20 | V |
| Rückstromspitze peak reverse recovery current | $I_F = 200 \text{ A}, -di_F/dt = 4000 \text{ A}/\mu\text{s}$ $V_R = 600 \text{ V}$ $V_{GE} = -15 \text{ V}$ | $T_{vj} = 25^{\circ}\text{C}$ | I_{RM} | | 240 | | A |
| | | $T_{vj} = 125^{\circ}\text{C}$ | | | 300 | | A |
| Sperrverzögerungsladung recovered charge | $I_F = 200 \text{ A}, -di_F/dt = 4000 \text{ A}/\mu\text{s}$ $V_R = 600 \text{ V}$ $V_{GE} = -15 \text{ V}$ | $T_{vj} = 25^{\circ}\text{C}$ | Q_r | | 23,0 | | μC |
| | | $T_{vj} = 125^{\circ}\text{C}$ | | | 42,0 | | μC |
| Abschaltenergie pro Puls reverse recovery energy | $I_F = 200 \text{ A}, -di_F/dt = 4000 \text{ A}/\mu\text{s}$ $V_R = 600 \text{ V}$ $V_{GE} = -15 \text{ V}$ | $T_{vj} = 25^{\circ}\text{C}$ | E_{rec} | | 6,00 | | mJ |
| | | $T_{vj} = 125^{\circ}\text{C}$ | | | 14,0 | | mJ |
| Innerer Wärmewiderstand thermal resistance, junction to case | pro Diode per diode | | R_{thJC} | | | 0,18 | K/W |
| Übergangs-Wärmewiderstand thermal resistance, case to heatsink | pro Diode / per diode $\lambda_{Paste} = 1 \text{ W}/(\text{m}\cdot\text{K}) / \lambda_{grease} = 1 \text{ W}/(\text{m}\cdot\text{K})$ | | R_{thCH} | | 0,06 | | K/W |

prepared by: Martin Knecht

date of publication: 2004-6-28

approved by: Wilhelm Rusche

revision: 2.0

Vorläufige Daten
preliminary data

Diode-Brems-Chopper / Diode-brake-chopper

Höchstzulässige Werte / maximum rated values

| | | | | |
|---|--|-----------|-------|----------------------|
| Periodische Spitzensperrspannung repetitive peak reverse voltage | $T_{vj} = 25^{\circ}\text{C}$ | V_{RRM} | 1200 | V |
| Dauergleichstrom DC forward current | | I_F | 300 | A |
| Periodischer Spitzenstrom repetitive peak forw. current | $t_p = 1 \text{ ms}$ | I_{FRM} | 600 | A |
| Grenzlastintegral I^2t - value | $V_R = 0 \text{ V}, t_p = 10 \text{ ms}, T_{vj} = 125^{\circ}\text{C}$ | I^2t | 19000 | A^2s |

Charakteristische Werte / characteristic values

| | | | | min. | typ. | max. | |
|---|---|--------------------------------|------------|------|------|-------|---------------|
| Durchlaßspannung forward voltage | $I_F = 300 \text{ A}, V_{GE} = 0 \text{ V}$ | $T_{vj} = 25^{\circ}\text{C}$ | V_F | | 1,80 | 2,30 | V |
| | $I_F = 300 \text{ A}, V_{GE} = 0 \text{ V}$ | $T_{vj} = 125^{\circ}\text{C}$ | | | 1,70 | 2,20 | V |
| Rückstromspitze peak reverse recovery current | $I_F = 300 \text{ A}, -di_F/dt = 5400 \text{ A}/\mu\text{s}$ $V_R = 600 \text{ V}$ $V_{GE} = -15 \text{ V}$ | $T_{vj} = 25^{\circ}\text{C}$ | I_{RM} | | 350 | | A |
| | | $T_{vj} = 125^{\circ}\text{C}$ | | | 420 | | A |
| Sperrverzögerungsladung recovered charge | $I_F = 300 \text{ A}, -di_F/dt = 5400 \text{ A}/\mu\text{s}$ $V_R = 600 \text{ V}$ $V_{GE} = -15 \text{ V}$ | $T_{vj} = 25^{\circ}\text{C}$ | Q_r | | 28,0 | | μC |
| | | $T_{vj} = 125^{\circ}\text{C}$ | | | 58,0 | | μC |
| Abschaltenergie pro Puls reverse recovery energy | $I_F = 300 \text{ A}, -di_F/dt = 5400 \text{ A}/\mu\text{s}$ $V_R = 600 \text{ V}$ $V_{GE} = -15 \text{ V}$ | $T_{vj} = 25^{\circ}\text{C}$ | E_{rec} | | 9,00 | | mJ |
| | | $T_{vj} = 125^{\circ}\text{C}$ | | | 21,0 | | mJ |
| Innerer Wärmewiderstand thermal resistance, junction to case | pro Diode per diode | | R_{thJC} | | | 0,125 | K/W |
| Übergangs-Wärmewiderstand thermal resistance, case to heatsink | pro Diode / per diode $\lambda_{Paste} = 1 \text{ W}/(\text{m}\cdot\text{K}) / \lambda_{grease} = 1 \text{ W}/(\text{m}\cdot\text{K})$ | | R_{thCH} | | 0,06 | | K/W |

prepared by: Martin Knecht

date of publication: 2004-6-28

approved by: Wilhelm Rusche

revision: 2.0

Technische Information / technical information

IGBT-Module
IGBT-modules

BSM200GAL120DLC



Vorläufige Daten preliminary data

Modul / module

| | | | | | |
|--|--|---------------------|--------------------------------|------|---------|
| Isolations-Prüfspannung insulation test voltage | RMS, f = 50 Hz, t = 1 min. | V _{ISOL} | 2,5 | | kV |
| Material Modulgrundplatte material of module baseplate | | | Cu | | |
| Material für innere Isolation material for internal insulation | | | Al ₂ O ₃ | | |
| Kriechstrecke creepage distance | Kontakt - Kühlkörper / terminal to heatsink Kontakt - Kontakt / terminal to terminal | | 20,0 | | mm |
| Luftstrecke clearance distance | Kontakt - Kühlkörper / terminal to heatsink Kontakt - Kontakt / terminal to terminal | | 11,0 | | mm |
| Vergleichszahl der Kriechwegbildung comparative tracking index | | CTI | > 425 | | |
| | | | min. | typ. | max. |
| Übergangs-Wärmewiderstand thermal resistance, case to heatsink | pro Modul / per module $\lambda_{\text{Paste}} = 1 \text{ W/(m}\cdot\text{K)} / \lambda_{\text{grease}} = 1 \text{ W/(m}\cdot\text{K)}$ | R _{thCH} | 0,01 | | K/W |
| Modulinduktivität stray inductance module | | L _{sCE} | 20 | | nH |
| Modulleitungswiderstand, Anschlüsse - Chip module lead resistance, terminals - chip | T _c = 25°C, pro Schalter / per switch | R _{CC+EE'} | 0,70 | | mΩ |
| Höchstzulässige Sperrschichttemperatur maximum junction temperature | Wechselrichter, Brems-Chopper / Inverter, Brake-Chopper | T _{vj max} | | | 150 °C |
| Temperatur im Schaltbetrieb temperature under switching conditions | Wechselrichter, Brems-Chopper / Inverter, Brake-Chopper | T _{vj op} | -40 | | 125 °C |
| Lagertemperatur storage temperature | | T _{stg} | -40 | | 125 °C |
| Anzugsdrehmoment f. mech. Befestigung mounting torque | Schraube / screw M6 | M | 3,00 | - | 6,00 Nm |
| Anzugsdrehmoment f. elektr. Anschlüsse terminal connection torque | Schraube / screw M6 | M | 2,5 | - | 5,0 Nm |
| Gewicht weight | | G | 340 | | g |

Mit dieser technischen Information werden Halbleiterbauelemente spezifiziert, jedoch keine Eigenschaften zugesichert. Sie gilt in Verbindung mit den zugehörigen technischen Erläuterungen.

This technical information specifies semiconductor devices but guarantees no characteristics. It is valid with the appropriate technical explanations.

| | |
|-----------------------------|--------------------------------|
| prepared by: Martin Knecht | date of publication: 2004-6-28 |
| approved by: Wilhelm Rusche | revision: 2.0 |

Vorläufige Daten
preliminary data

Ausgangskennlinie IGBT-Wechselr. (typisch)
output characteristic IGBT-inverter (typical)
 $I_c = f(V_{CE})$
 $V_{GE} = 15\text{ V}$

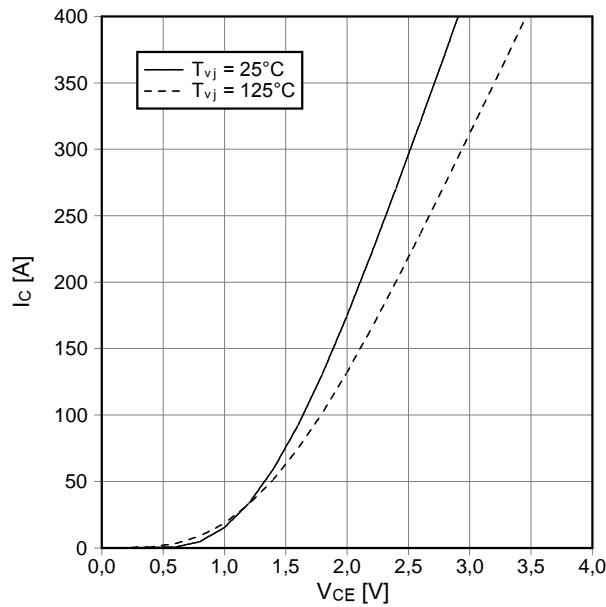

Ausgangskennlinienfeld IGBT-Wechselr. (typisch)
output characteristic IGBT-inverter (typical)
 $I_c = f(V_{CE})$
 $T_{vj} = 125^\circ\text{C}$

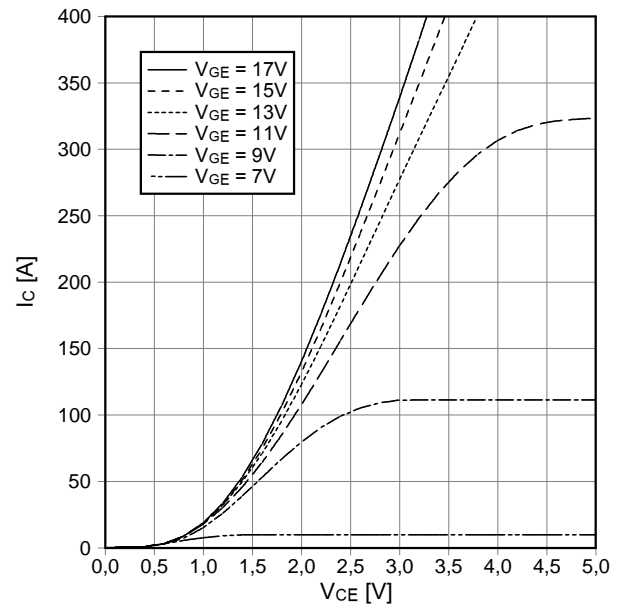

Übertragungscharakteristik IGBT-Wechselr. (typisch)
transfer characteristic IGBT-inverter (typical)
 $I_c = f(V_{GE})$
 $V_{CE} = 20\text{ V}$

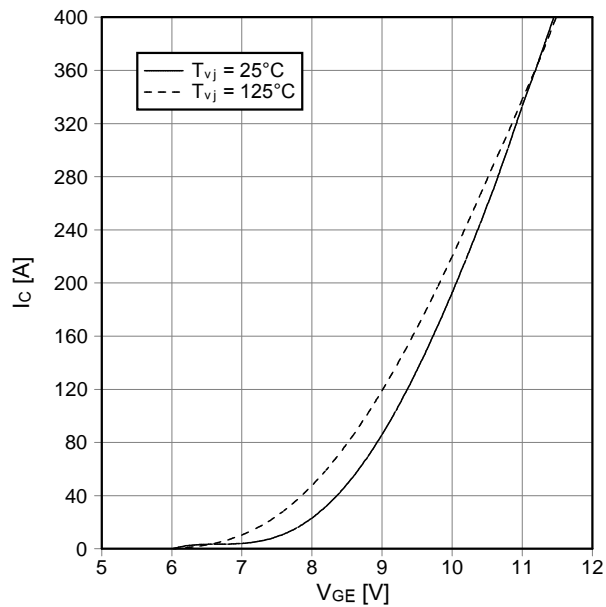

Schaltverluste IGBT-Wechselr. (typisch)
switching losses IGBT-inverter (typical)
 $E_{on} = f(I_c)$, $E_{off} = f(I_c)$
 $V_{GE} = \pm 15\text{ V}$, $R_{Gon} = 4,7\ \Omega$, $R_{Goff} = 4,7\ \Omega$, $V_{CE} = 600\text{ V}$

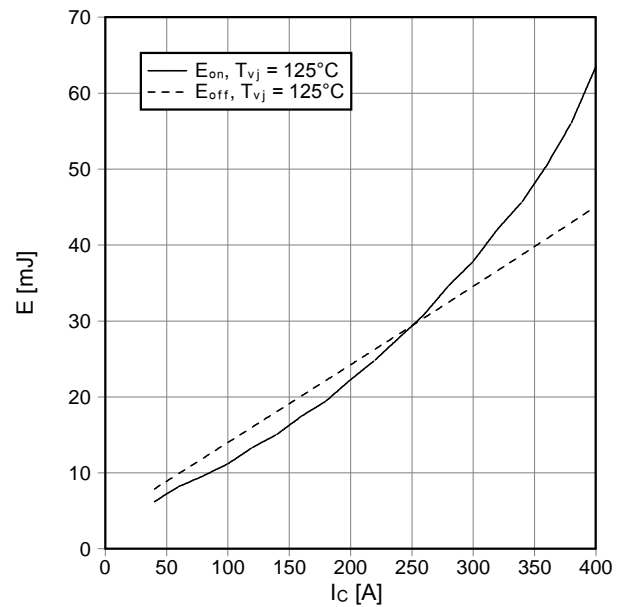

| | |
|-----------------------------|--------------------------------|
| prepared by: Martin Knecht | date of publication: 2004-6-28 |
| approved by: Wilhelm Rusche | revision: 2.0 |

Vorläufige Daten
preliminary data

Schaltverluste IGBT-Wechselr. (typisch)
switching losses IGBT-Inverter (typical)
 $E_{on} = f(R_G)$, $E_{off} = f(R_G)$
 $V_{GE} = \pm 15\text{ V}$, $I_C = 200\text{ A}$, $V_{CE} = 600\text{ V}$

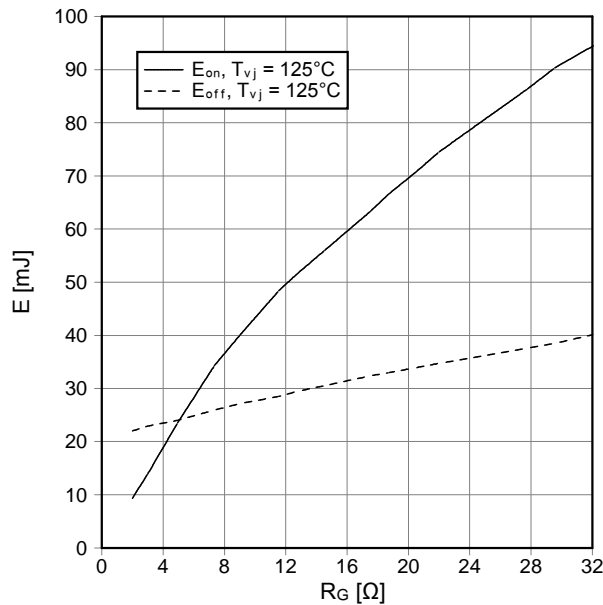

Transienter Wärmewiderstand IGBT-Wechselr.
transient thermal impedance IGBT-inverter
 $Z_{thJC} = f(t)$

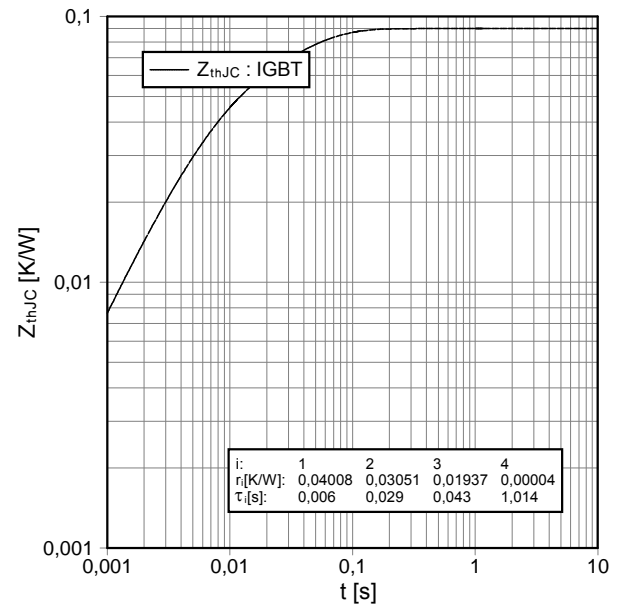

| | | | | |
|------------|---------|---------|---------|---------|
| i: | 1 | 2 | 3 | 4 |
| r_i [K/W]: | 0,04008 | 0,03051 | 0,01937 | 0,00004 |
| τ_i [s]: | 0,006 | 0,029 | 0,043 | 1,014 |

Sicherer Rückwärts-Arbeitsbereich IGBT-Wr. (RBSOA)
reverse bias safe operating area IGBT-inv. (RBSOA)
 $I_C = f(V_{CE})$
 $V_{GE} = \pm 15\text{ V}$, $R_{Goff} = 4,7\ \Omega$, $T_{vj} = 125^\circ\text{C}$

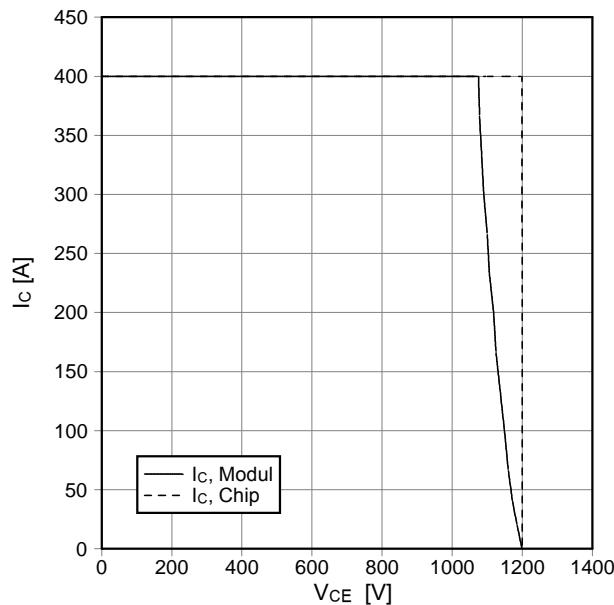

Durchlaßkennlinie der Diode-Wechselr. (typisch)
forward characteristic of diode-inverter (typical)
 $I_F = f(V_F)$

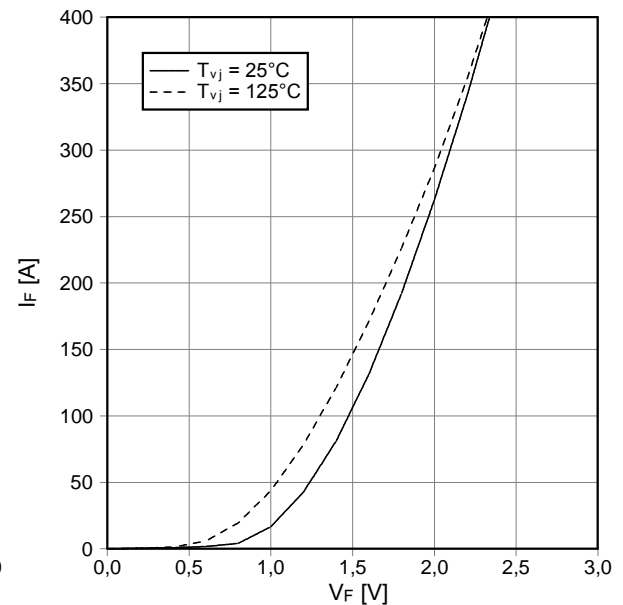

| | |
|-----------------------------|--------------------------------|
| prepared by: Martin Knecht | date of publication: 2004-6-28 |
| approved by: Wilhelm Rusche | revision: 2.0 |

Vorläufige Daten
preliminary data

Schaltverluste Diode-Wechselr. (typisch)
switching losses diode-inverter (typical)

$E_{rec} = f(I_F)$
 $R_{Gon} = 4,7 \Omega, V_{CE} = 600 V$

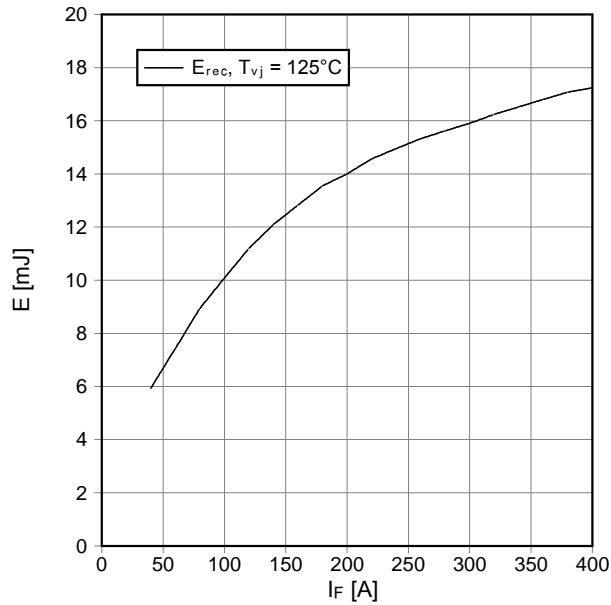

Schaltverluste Diode-Wechselr. (typisch)
switching losses diode-inverter (typical)

$E_{rec} = f(R_G)$
 $I_F = 200 A, V_{CE} = 600 V$

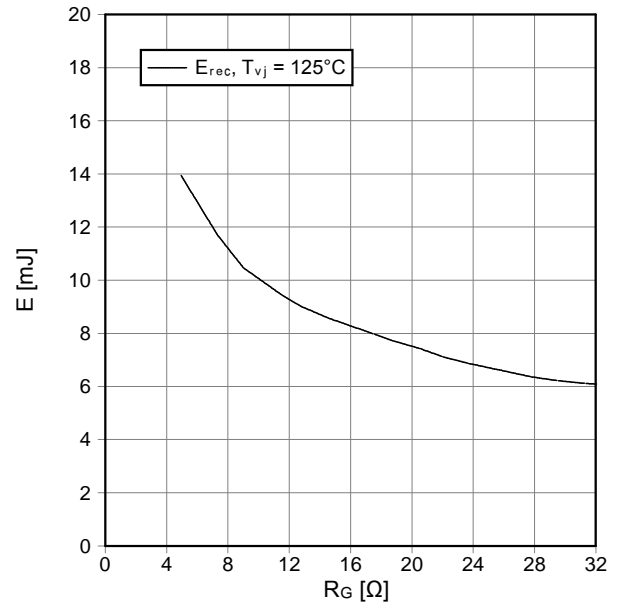

Transienter Wärmewiderstand Diode-Wechselr.
transient thermal impedance diode-inverter

$Z_{thJC} = f(t)$

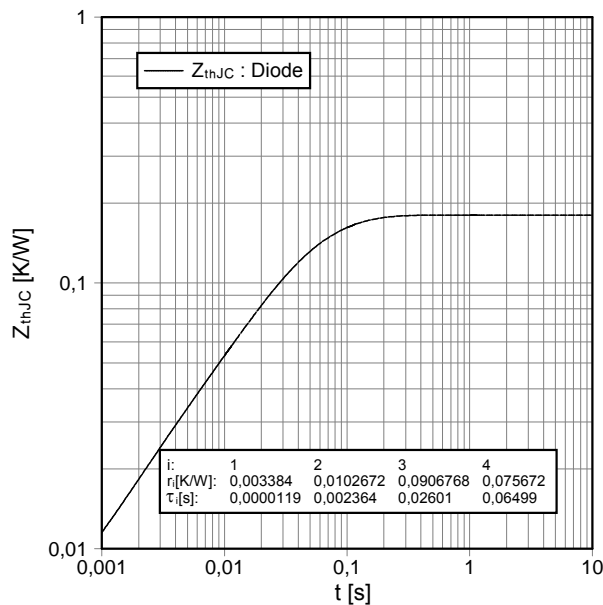

Durchlaßkennlinie der Diode-Brems-Chopper (typisch)
forward characteristic of diode-brake-chopper (typical)

$I_F = f(V_F)$

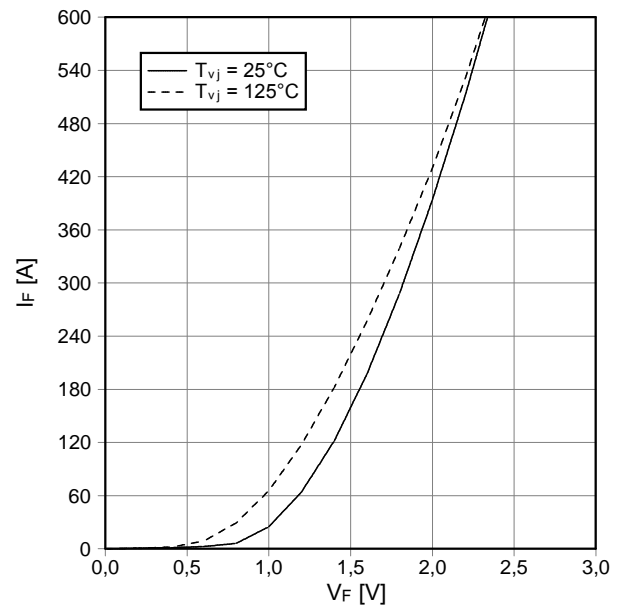

| | |
|-----------------------------|--------------------------------|
| prepared by: Martin Knecht | date of publication: 2004-6-28 |
| approved by: Wilhelm Rusche | revision: 2.0 |

Vorläufige Daten
preliminary data

Schaltverluste Diode-Brems-Chopper (typisch)
switching losses diode-brake-chopper (typical)
 $E_{rec} = f(I_F)$
 $R_{Gon} = \Omega, V_{CE} = 600 V$

Schaltverluste Diode-Brems-Chopper (typisch)
switching losses diode-brake-chopper (typical)
 $E_{rec} = f(R_G)$
 $I_F = 300 A, V_{CE} = 600 V$

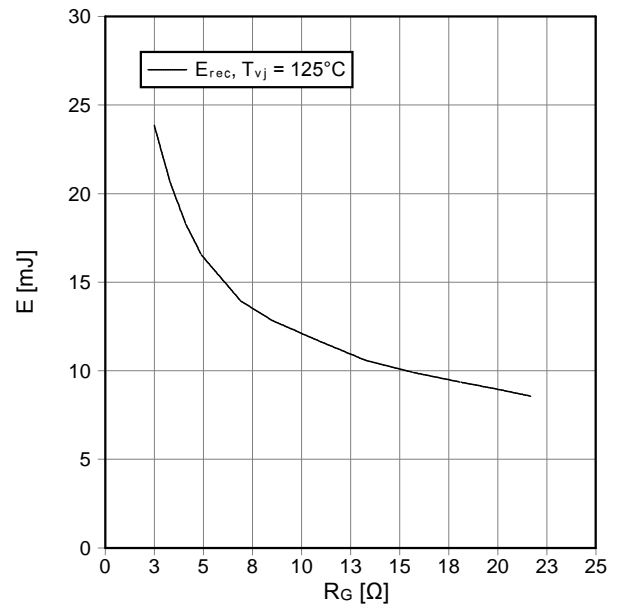
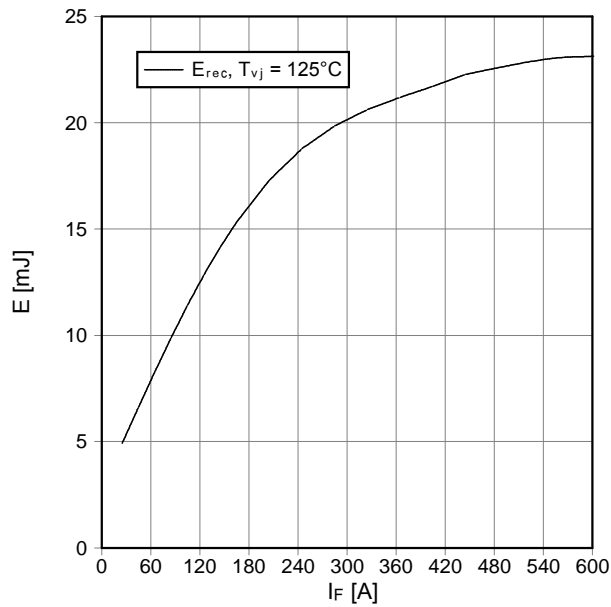

Transienter Wärmewiderstand Diode-Brems-Chopper
transient thermal impedance diode-brake-chopper
 $Z_{thJC} = f(t)$

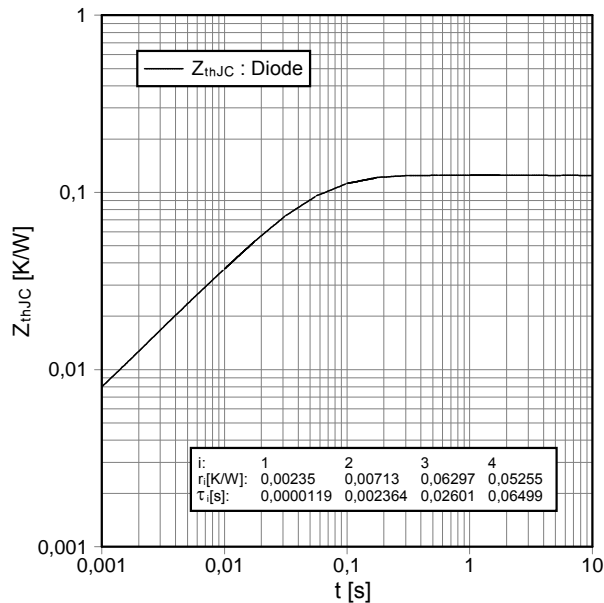

| | |
|-----------------------------|--------------------------------|
| prepared by: Martin Knecht | date of publication: 2004-6-28 |
| approved by: Wilhelm Rusche | revision: 2.0 |

Vorläufige Daten
preliminary data

Schaltplan / circuit diagram

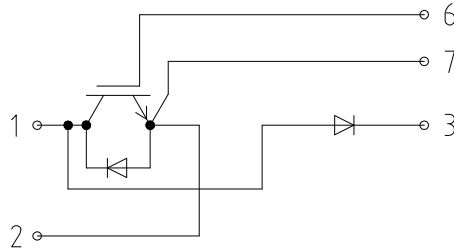

Gehäuseabmessungen / package outlines

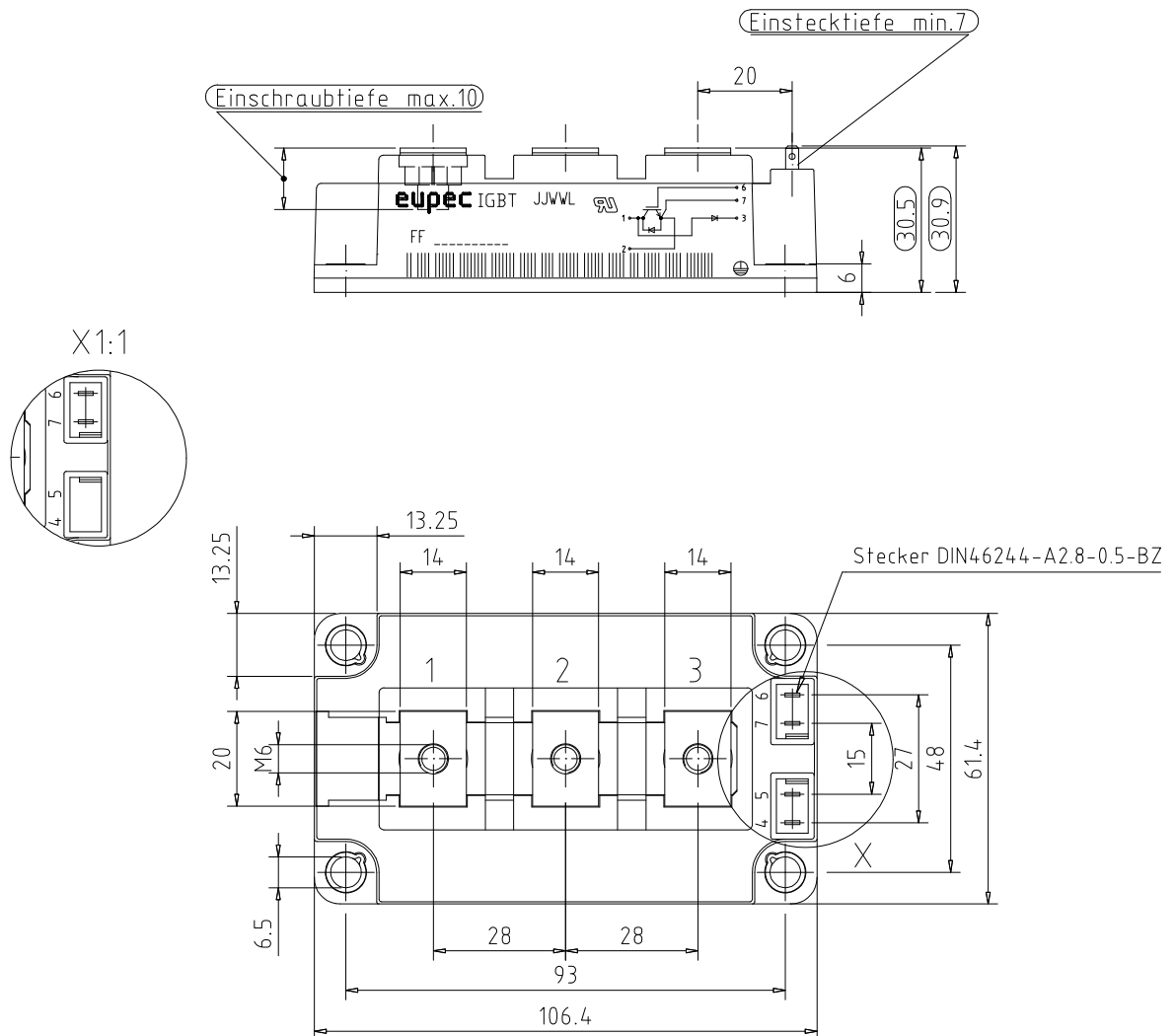

| | |
|-----------------------------|--------------------------------|
| prepared by: Martin Knecht | date of publication: 2004-6-28 |
| approved by: Wilhelm Rusche | revision: 2.0 |

Nutzungsbedingungen

Die in diesem Produktdatenblatt enthaltenen Daten sind ausschließlich für technisch geschultes Fachpersonal bestimmt. Die Beurteilung der Geeignetheit dieses Produktes für die von Ihnen anvisierte Anwendung sowie die Beurteilung der Vollständigkeit der bereitgestellten Produktdaten für diese Anwendung obliegt Ihnen bzw. Ihren technischen Abteilungen.

In diesem Produktdatenblatt werden diejenigen Merkmale beschrieben, für die wir eine liefervertragliche Gewährleistung übernehmen. Eine solche Gewährleistung richtet sich ausschließlich nach Maßgabe der im jeweiligen Liefervertrag enthaltenen Bestimmungen. Garantien jeglicher Art werden für das Produkt und dessen Eigenschaften keinesfalls übernommen.

Sollten Sie von uns Produktinformationen benötigen, die über den Inhalt dieses Produktdatenblatts hinausgehen und insbesondere eine spezifische Verwendung und den Einsatz dieses Produktes betreffen, setzen Sie sich bitte mit dem für Sie zuständigen Vertriebsbüro in Verbindung (siehe www.eupec.com, Vertrieb&Kontakt). Für Interessenten halten wir Application Notes bereit.

Aufgrund der technischen Anforderungen könnte unser Produkt gesundheitsgefährdende Substanzen enthalten. Bei Rückfragen zu den in diesem Produkt jeweils enthaltenen Substanzen setzen Sie sich bitte ebenfalls mit dem für Sie zuständigen Vertriebsbüro in Verbindung.

Sollten Sie beabsichtigen, das Produkt in Anwendungen der Luftfahrt, in gesundheits- oder lebensgefährdenden oder lebenserhaltenden Anwendungsbereichen einzusetzen, bitten wir um Mitteilung. Wir weisen darauf hin, dass wir für diese Fälle

- die gemeinsame Durchführung eines Risiko- und Qualitätsassessments;
- den Abschluss von speziellen Qualitätssicherungsvereinbarungen;
- die gemeinsame Einführung von Maßnahmen zu einer laufenden Produktbeobachtung dringend empfehlen und gegebenenfalls die Belieferung von der Umsetzung solcher Maßnahmen abhängig machen.

Soweit erforderlich, bitten wir Sie, entsprechende Hinweise an Ihre Kunden zu geben.

Inhaltliche Änderungen dieses Produktdatenblatts bleiben vorbehalten.

Terms & Conditions of usage

The data contained in this product data sheet is exclusively intended for technically trained staff. You and your technical departments will have to evaluate the suitability of the product for the intended application and the completeness of the product data with respect to such application.

This product data sheet is describing the characteristics of this product for which a warranty is granted. Any such warranty is granted exclusively pursuant the terms and conditions of the supply agreement. There will be no guarantee of any kind for the product and its characteristics.

Should you require product information in excess of the data given in this product data sheet or which concerns the specific application of our product, please contact the sales office, which is responsible for you (see www.eupec.com, sales&contact). For those that are specifically interested we may provide application notes.

Due to technical requirements our product may contain dangerous substances. For information on the types in question please contact the sales office, which is responsible for you.

Should you intend to use the Product in aviation applications, in health or live endangering or life support applications, please notify.

Please note, that for any such applications we urgently recommend

- to perform joint Risk and Quality Assessments;
- the conclusion of Quality Agreements;
- to establish joint measures of an ongoing product survey, and that we may make delivery depended on the realization of any such measures.

If and to the extent necessary, please forward equivalent notices to your customers.

Changes of this product data sheet are reserved.