

SERIES: AMT303 **DESCRIPTION:** MODULAR ENCODER

FEATURES

- U, V, W commutation lines
- small size 37 mm
- line count up to 1024 PPR
- optional line driver output (303LD)
- single pulse index
- capacitive ASIC technology
- modular locking hub design for ease of installation
- 2, 4, 6, 8, 10, 12, or 20 pole motors
- 6 programmable functions
- 'One Touch' commutation signal alignment

ELECTRICAL

| parameter | conditions/description | min | nom | max | units |
|--------------------------------|---|-----|-----|------|-------|
| power supply | | 4.5 | 5 | 5.5 | V |
| current consumption | | | 8 | 10 | mA |
| commutation output signals | U, V, W phase | | | | |
| commutation pole | 2, 4, 6, 8, 10, 12, 20 (software programmable) | | | | |
| incremental output signals | A, B, Z (AMT303) A, \bar{A} , B, \bar{B} , Z, \bar{Z} (AMT303LD) | | | | |
| incremental output waveform | square wave | | | | |
| incremental output resolutions | 96, 192, 200, 250, 384, 400, 500, 512, 800, 1000, 1024 | | | | PPR |
| index | one pulse per 360 deg. | | | | |
| incremental output current | output voltage - sourcing to +5 V at -32 mA | 3.8 | | | V |
| | output voltage - sinking to ground at -32 mA | | | 0.55 | V |

MECHANICAL

| parameter | conditions/description | min | nom | max | units |
|------------------|--|-----|-----|-----|-------|
| output range | | | | 360 | deg. |
| mounting options | A) 2 x M1.6 on 16 mm (0.63") bolt circle B) 2 x #4 on 19.05 mm (0.75") bolt circle C) 2 x M1.6 or M2 on 20 mm (0.787") bolt circle D) 3 x M1.6 or M2 on 20.9 mm (0.823") bolt circle with washers in option B holes E) 3 x M1.6 or M2 on 22 mm (0.866") bolt circle F) 4 x M1.6 or M2 on 25.4 mm (1") bolt circle | | | | |

ENVIRONMENTAL

| parameter | conditions/description | min | nom | max | units |
|-----------------------|-------------------------------|-----|-----|-----|-------|
| operating temperature | | -40 | | 125 | °C |
| humidity | | | | 85 | % |
| vibration | 1.5 mm, 3 directions, 2 hours | 10 | | 55 | Hz |





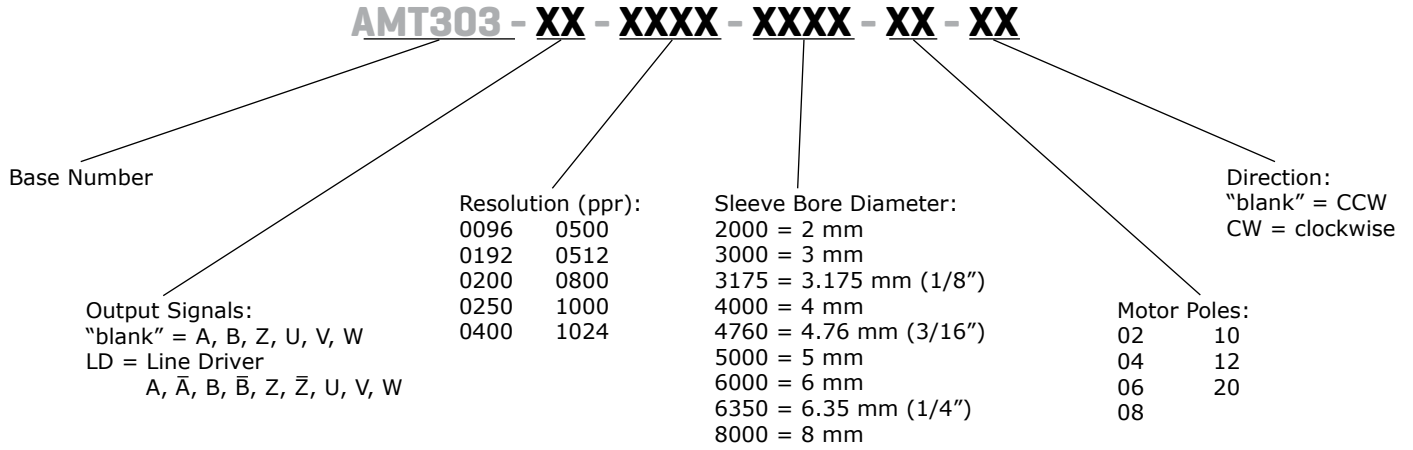

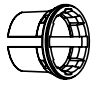

PART NUMBER KEY

For customers that prefer a specific AMT303 configuration, please reference the custom configuration key below.



AMT303 KITS

In order to provide maximum flexibility for our customers, the AMT303 series is provided in kit form standard. This allows the user to implement the encoder into a range of applications using one sku#, reducing engineering and inventory costs.

| SLEEVES | | | | | | | | |
|---|---|---|--|---|---|---|---|---|
|  |  |  |  |  |  |  |  |  |
| 8mm | 1/4 inch (6.35mm) | 6mm | 5mm | 3/16 inch (4.76mm) | 4mm | 1/8 inch (3.175mm) | 3mm | 2mm |
| Blue | Snow | Red1 | Green1 | Yellow1 | Gray60 | Purple1 | Orange | Light Sky Blue |

ORDERING GUIDE

AMT303XX-V

Output Signals:
"blank" = A, B, Z, U, V, W signals
LD = Line Driver
A, \bar{A} , B, \bar{B} , Z, \bar{Z} , U, V, W signals

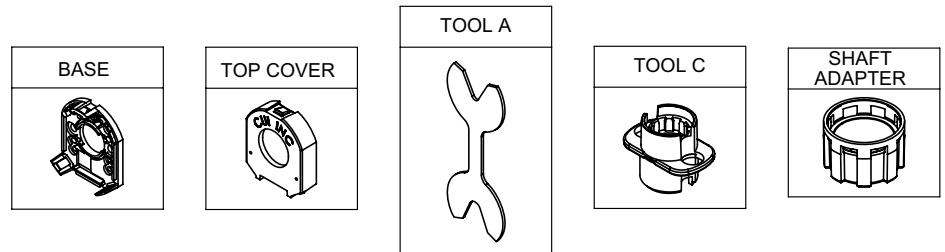

ENCODER INTERFACE

| PINOUT CONNECTOR 1 | | |
|--------------------|----------|----------|
| FUNCTION | | |
| # | AMT303 | AMT303LD |
| 14 | GND_C | GND_C |
| 13 | N/A | -Z |
| 12 | Z | Z |
| 11 | N/A | -A |
| 10 | A | A |
| 9 | N/A | -B |
| 8 | B | B |
| 7 | V | V |
| 6 | 5 V+ | 5 V+ |
| 5 | W | W |
| 4 | GND | GND |
| 3 | U | U |
| 2 | zero set | zero set |
| 1 | N/A | N/A |

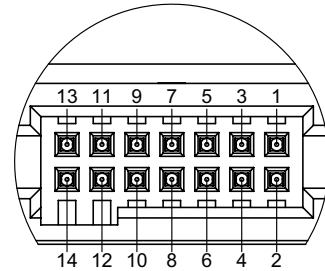
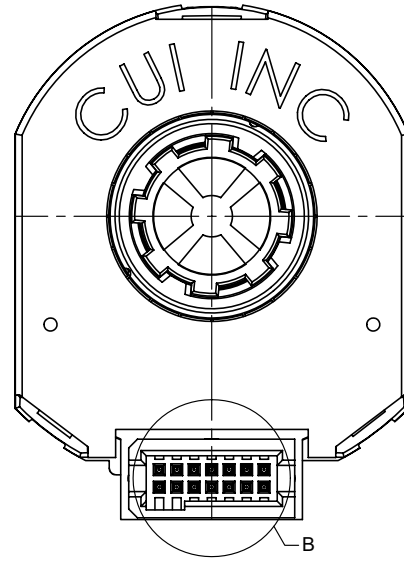

DETAIL B
SCALE 4 : 1

Encoder Side

Demo Board Side

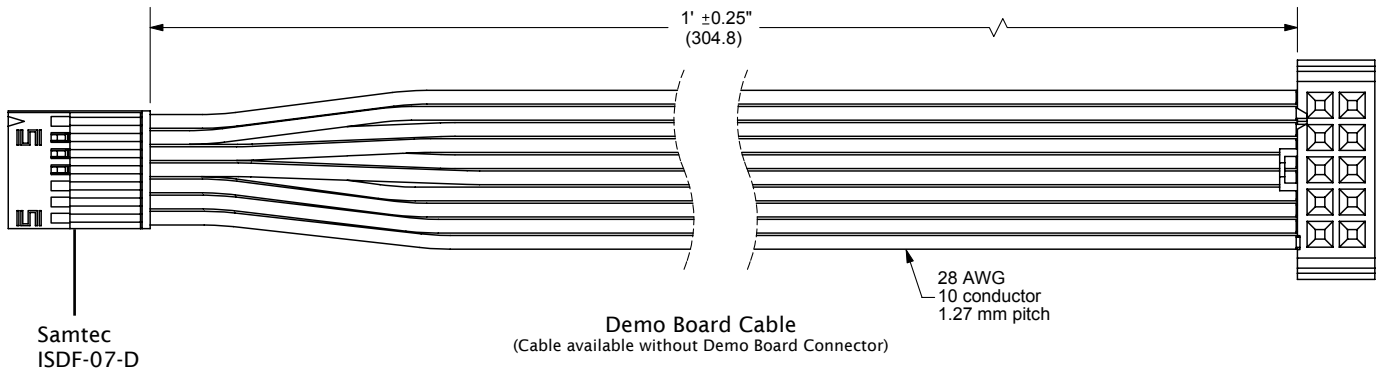

MECHANICAL DRAWING

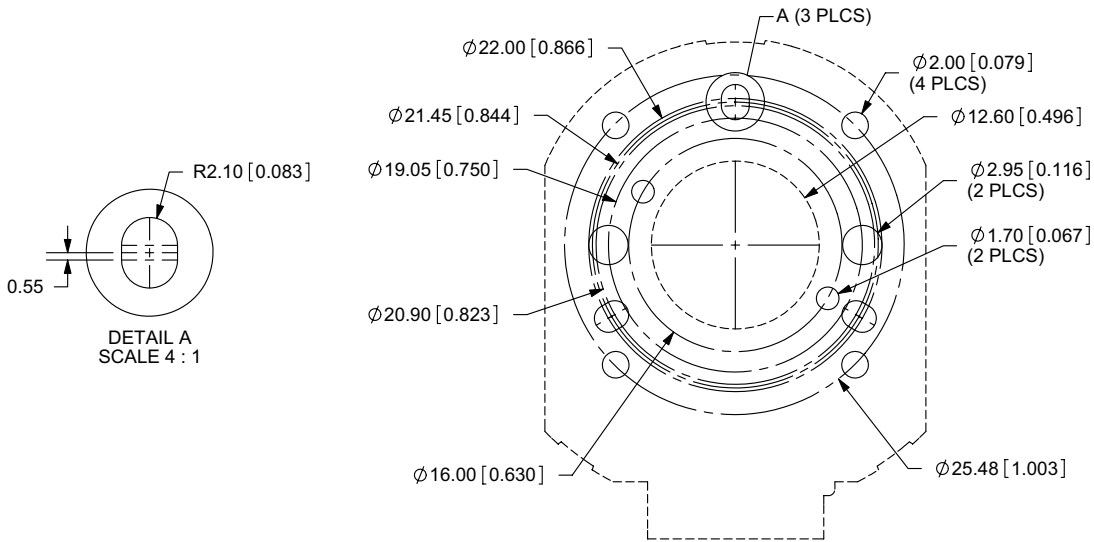
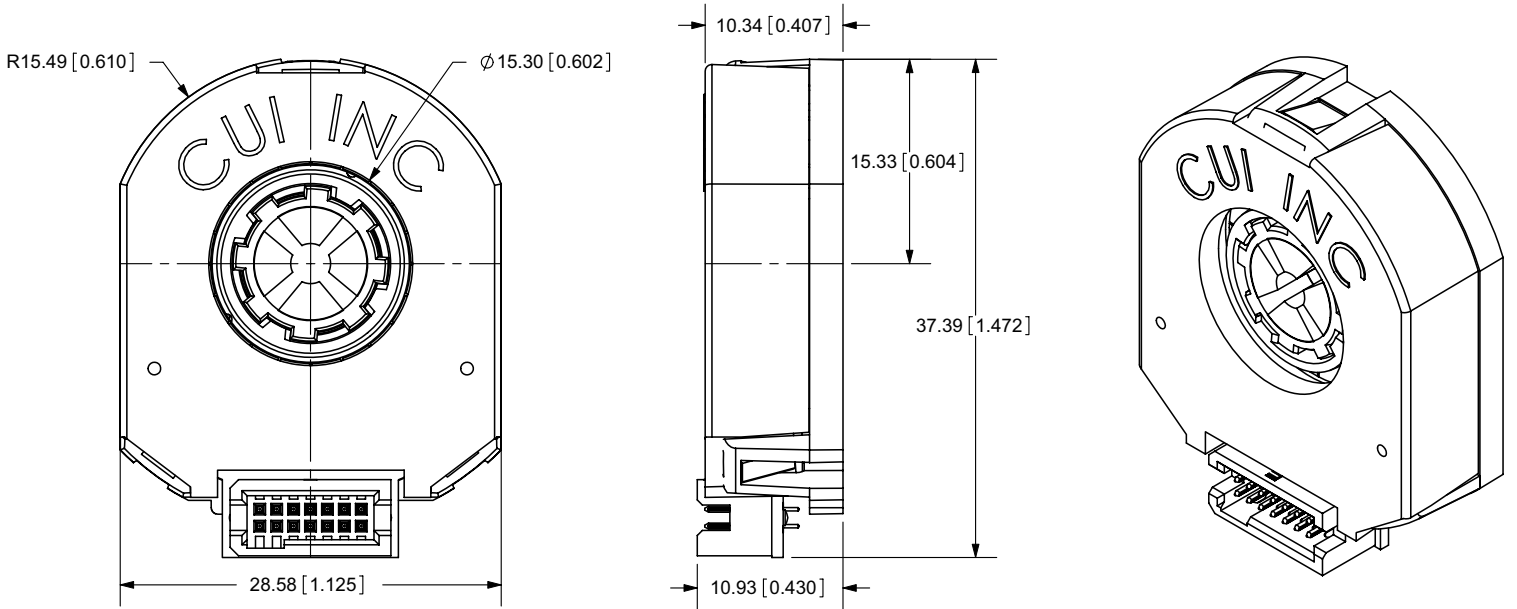

TOLERANCE:
±0.05mm UNLESS OTHERWISE SPECIFIED



ENCODER OPERATIONAL MODE

Initialization mode:

- At power up the encoder goes through an initiation and stabilization procedure. This includes microprocessor stabilization and the program for combining Coarse and Fine channel of the encoder for getting the absolute start position. This takes less than 0.1 seconds.

Tracking mode:

- MCU 12 bit position register is updated from Fine Asic every 48 μ s.
- The commutation program in the MCU has a compensation for the average delay caused by the update rate, leaving a remaining jitter of less than 24 μ s RMS.
 - The communication jitter expressed in electrical degrees will be proportional speed and does not reach 6 deg RMS until the speed reaches the following values:

| | | | | | | |
|-----------------|--------|--------|-------|-------|-------|-------|
| Pole Count | 4 | 6 | 8 | 10 | 12 | 20 |
| Speed Limit RPM | 17,361 | 11,574 | 8,681 | 6,944 | 5,787 | 3,472 |

COMMUTATION ALIGNMENT AND SETTING THE ZERO POINT

We strongly recommend the use of the AMT303 series demo board to set commutation zero. It greatly simplifies and expedites the process. The demo board also allows setting of resolution, # of motor poles, direction of quadrature increment, and commutation angle offset (when required). If you do not have or cannot obtain a demo board, use the following procedure to align the AMT303XX commutation angle with your motor:

1. Mount the AMT303 series encoder to the motor.
2. Put the motor in a 'locked rotor' condition. This is usually done by applying +V to phase A and ground to phase B. Consult your motor manufacturer if you are not certain how to lock the rotor for commutation alignment.
3. With the motor in a locked rotor position, pull pin# 2 (zero set) low to write the rotor position into non-volatile memory in the encoder.
4. Power cycle the encoder, i.e., remove power from it. The commutation position is now permanently aligned with the motor rotor zero position and will use this offset at initialization every time at startup.

Note: *The procedure is based on the standard "WYE" motor phase connection configuration. If your motor uses other than the "WYE" phase connection, you must acquire the AMT303 series demo board to program the required offset to align encoder commutation signal zero with motor zero position.*

AMT303 series demo board instructions can be found [HERE](#).

REVISION HISTORY

| rev. | description | date |
|------|-----------------|------------|
| 1.0 | initial release | 05/04/2011 |

The revision history provided is for informational purposes only and is believed to be accurate.



Headquarters
20050 SW 112th Ave.
Tualatin, OR 97062
800.275.4899

Fax 503.612.2383
cui.com
techsupport@cui.com

CUI offers a two (1) year limited warranty. Complete warranty information is listed on our website.

CUI reserves the right to make changes to the product at any time without notice. Information provided by CUI is believed to be accurate and reliable. However, no responsibility is assumed by CUI for its use, nor for any infringements of patents or other rights of third parties which may result from its use.

CUI products are not authorized or warranted for use as critical components in equipment that requires an extremely high level of reliability. A critical component is any component of a life support device or system whose failure to perform can be reasonably expected to cause the failure of the life support device or system, or to affect its safety or effectiveness.