

ISS.	DATE	E.C.N.	DESCRIPTION
1	17-Nov-08		FIRST ISSUE

© 2008 CARCLO
ALL DIMENSIONS IN mm

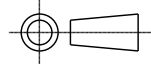

CUSTOMER DRAWING

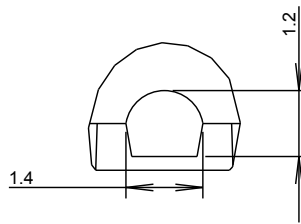
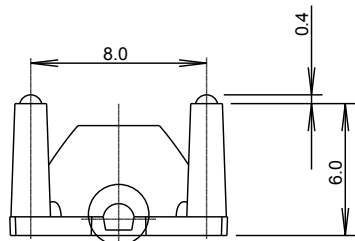
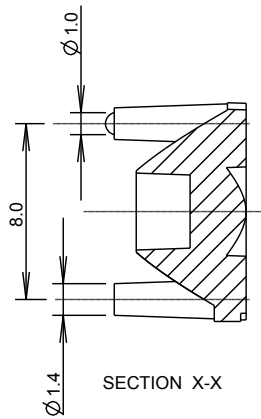
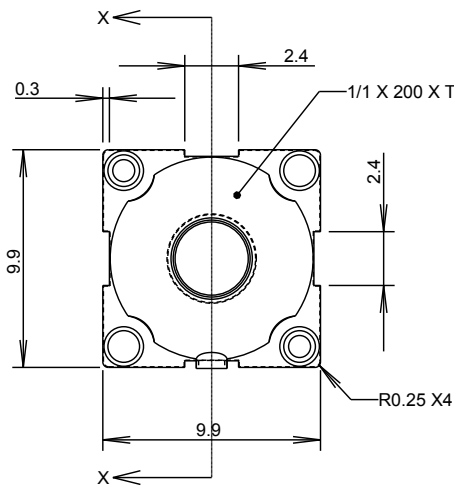

3D VIEW
SCALE 1:1

SEE DETAIL A

- NOTES:
1. MATERIAL - UV STABILISED POLYCARBONATE
2. INCLUSIONS SPECIFIED TO BS4301



CARCLO TECHNICAL PLASTICS (SLOUGH) LTD.
111 BUCKINGHAM AVE, SLOUGH
SL1 4PF, ENGLAND
TEL: +44 1753 575011 FAX: +44 1753 811359
e-mail: design@ctpcoil.co.uk

GENERAL TOLERANCES (UNLESS STATED)

LINEAR	ANGULAR
X +/- 0.25	X +/- 1°
X.X +/- 0.1	X.X +/- 0.5°
X.XX +/- 0.05	X.XX +/- 0.1°

CUSTOMER

CARCLO

TITLE

10MM SQUARE LED OPTIC
FRONT LENS VERSION

DRAWN

DATE

AJD

17-Nov-08

CHK'D

DATE

APP'D

DATE

SCALE

4:1

COIL PART No.

10417

SIZE

A4

COIL DRG. No.

60553

SHEET

1 OF 2

ISS.	DATE	E.C.N.	DESCRIPTION
1	17-Nov-08		FIRST ISSUE

© 2008 CARCLO
ALL DIMENSIONS IN mm

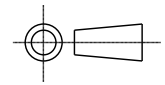

PCB GLUE PAD AND ALIGNMENT HOLE LAYOUT DIMENSIONS

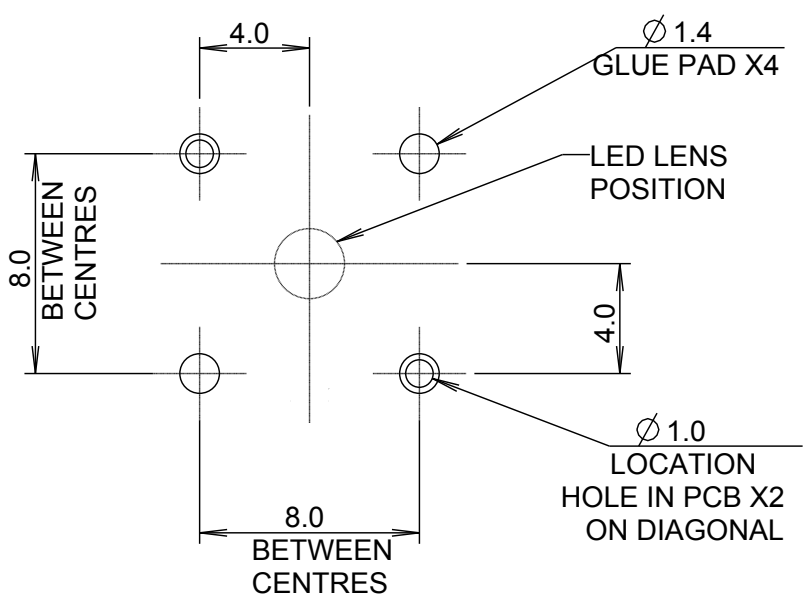

carclo
technical plastics

CARCLO TECHNICAL PLASTICS (SLOUGH)
111 BUCKINGHAM AVE, SLOUGH
SL1 4PF, ENGLAND
TEL: +44 1753 575011 FAX: +44 1753 811359
e-mail: design@carclo-optics.com}

GENERAL TOLERANCES (UNLESS STATED)

LINEAR	ANGULAR
X +/- 0.25	X +/- 1°
X.X +/- 0.1	X.X +/- 0.5°
X.XX +/- 0.05	X.XX +/- 0.1°

CUSTOMER		
CARCLO		
TITLE		
10MM SQUARE LED OPTIC FRONT LENS VERSION		
DRAWN	DATE	
AJD	25-Jun-07	
CHK'D	DATE	
APP'D	DATE	
SCALE	CARCLO PART No.	
5:1	10417	
SIZE	CARCLO DRG. No.	SHEET
A4	60553	2 OF 2