

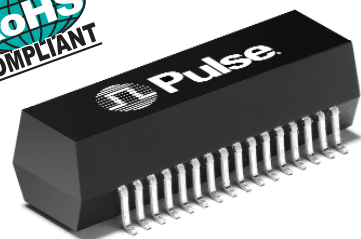





T3/DS3/E3/STS-1 TRANSFORMERS

Eight Transformers Designed for T3, DS3, E3 and STS-1 Interface



-  Eight transformers in a surface mount package
-  Models matched to leading transceiver ICs
-  Return loss meets requirements of G.703
-  Recognized by UL1950 (some parts pending approval)
-  Isolation voltage: 1500Vrms

Electrical Specifications @ 25°C

RoHS-5 Compliant PN#	RoHS-6 Compliant PN#	Turns Ratio (Pri:Sec ±2%)	OCL Primary @ 25°C (μH MIN)	LL (μH MAX)	C _{ww} (pF MAX)	Isolation Voltage (Vrms MIN)	Package/Schematic	Primary Pins
T3048	T3048NL	1:1	40	.150	10	1500	YB/1	1-2, 3-4, 5-6, 7-8 9-10, 11-12, 13-14, 15-16
T3049	T3049NL	1:2	19	.150	10	1500	YB/1	1-2, 3-4, 5-6, 7-8 9-10, 11-12, 13-14, 15-16
TX3047*	TX3047NL*	1:1	100	.150	10	1500	YB/1	1-2, 3-4, 5-6, 7-8 9-10, 11-12, 13-14, 15-16
TX3045*	TX3045NL*	1:1 & 1:2	100 & 40	.120	10	1500	YB/1	1-2, 5-6, 9-10, 13-14 & 3-4, 7-8, 11-12, 15-16

*NOTE: Operating Temperature Range: -40°C to +85°C.

For Tape & Reel packaging, add a "T" suffix to the part number when ordering (e.g. T3048 becomes T3048T, and T3048NL becomes T3048NLT).

Mechanical

Schematic

YB

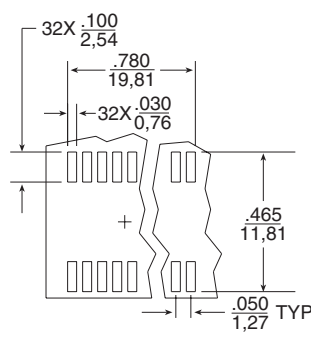
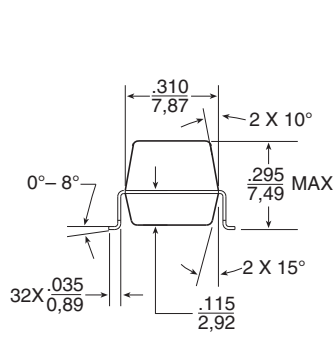
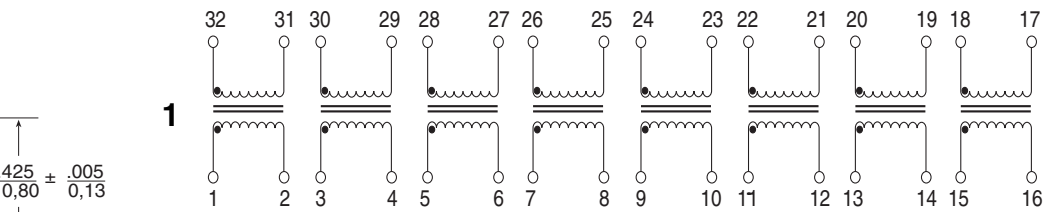
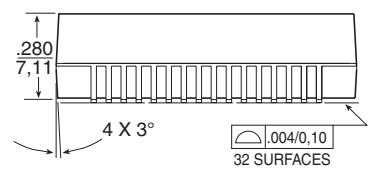
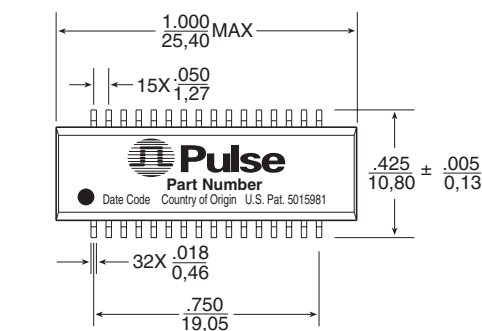

Weight27 grams
Tape & Reel200/reel
Tube20/tube

Dimensions: Inches
mm
Unless otherwise specified,
all tolerances are ± .010
0,25

For More Information:

Pulse Worldwide Headquarters 12220 World Trade Dr. San Diego, CA 92128 U.S.A. www.pulseeng.com TEL: 858 674 8100 FAX: 858 674 8262	Pulse Europe Einsteinstrasse 1 D-71083 Herrenberg Germany Tel: 49 7032 7806 116 Fax: 49 7032 7806 135	Pulse China Headquarters No. 1 Industrial District Changan, Dongguan China Tel: 86 769 85538070 Fax: 86 769 85538870	Pulse North China Room 1503 XinYin Building No. 888 YiShan Rd. Shanghai 200233 China Tel: 86 21 54643211/2 Fax: 86 21 54643210	Pulse South Asia 150 Kampong Ampat #07-01/02 KA Centre Singapore 368324 Tel: 65 6287 8998 Fax: 65 6280 0080	Pulse North Asia No. 26 Kao Ching Rd. Yang Mei Chen Taoyuan Hsien Taiwan, R. O. C. Tel: 886 3 4641811 Fax: 886 3 4641911
---	---	---	--	--	--

Performance warranty of products offered on this data sheet is limited to the parameters specified. Data is subject to change without notice. Other brand and product names mentioned herein may be trademarks or registered trademarks of their respective owners.
 © Copyright, 2006. Pulse Engineering, Inc. All rights reserved.

www.pulseeng.com

T663.B (9/06)