

“[Underlined blue text](#)” links to the corresponding page on the right.

TABLE of CONTENTS

| | |
|--|----|
| 01 - Mini-Line EE20 - 0.08VA-0.5VA | |
| EE20 / 4 - 0.08VA | 2 |
| EE20 / 6.1 - 0.35VA | 3 |
| EE20 / 10 - 0.50VA | 4 |
| 02 - Print-Line EI30 - 0.5VA-2.8 VA | |
| EI30 / 5 - 0.5VA | 5 |
| EI30 / 10.5 - 1VA | 6 |
| EI30 / 12.5 - 1.2VA | 7 |
| EI30 / 12.5 - 1.5VA | 8 |
| EI30 / 15.5 - 2VA | 9 |
| EI30 / 18 - 2.3VA | 10 |
| EI30 / 23 - 2.8VA | 11 |
| 03 - Print-Line EI38 - 3.2VA-4VA | |
| EI38 / 13.6 - 3.2VA | 12 |
| EI38 / 13.6 - 4VA | 13 |
| 04 - Print-Line EI42-EI54 - 5VA-16VA | |
| EI42 / 14.8 - 5VA | 14 |
| EI48 / 16.8 - 10VA | 15 |
| EI54 / 18.8 - 16VA | 16 |
| 05 - Transformers with mounting brackets - 5VA-50VA | |
| EI42 / 14.8 - 5VA | 17 |
| EI48 / 16.8 - 10VA | 18 |
| EI54 / 18.8 - 16VA | 19 |
| EI60 / 25.5 - 25VA | 20 |
| EI66 / 23 - 36VA | 21 |
| EI66 / 34.7 - 50VA (230V) | 22 |
| EI66 / 34.7 - 50VA (2x115V) | 23 |
| 06 - Low Profile Transformers - 2VA-30VA | |
| UI30 / 5.5 - 2VA | 24 |
| UI30 / 7.5 - 4VA | 25 |
| UI30 / 10.5 - 6VA | 26 |
| UI30 / 16.5 - 10VA | 27 |
| UI39 / 8 - 10VA | 28 |
| UI39 / 10.2 - 14VA | 29 |
| UI39 / 13.5 - 18VA | 30 |
| UI39 / 17 - 24VA | 31 |
| UI39 / 21 - 30VA | 32 |
| 07 - Compact Power Supplies - 8.4VA-60VA | |
| EI48 / 16.8 (AC) | 33 |
| EI48 / 16.8 (DC) | 33 |
| EI66 / 23 | 34 |
| EI84 / 29.5 | 34 |
| 08 - Ignition Transformers | |
| Spark-Line - 233-375mH | 35 |
| Spark-Line - Secondary external (1x) | 36 |
| Spark-Line - Secondary external (2x) | 37 |

LAMINATED TRANSFORMERS

Type EE20 / 4 - 0.08VA









AGENCY APPROVALS 

1. UL 506, File E113449 

2. UL 1585, File E175197 

| Primary (V) | Secondary (V / mA) | No-Load Voltage (V) | Schematic No. | Part Number | Agency Approvals |
|-------------|--------------------|---------------------|---------------|-------------|------------------|
| 230 | 6 / 13.30 | 9.20 | 1 | 020-5480.0 | 1/2 |
| 230 | 9 / 8.88 | 13.60 | 1 | 020-5481.0 | 1/2 |
| 230 | 12 / 6.67 | 18.30 | 1 | 020-5482.0 | 1/2 |
| 230 | 15 / 5.33 | 22.60 | 1 | 020-5483.0 | 1/2 |
| 230 | 18 / 4.44 | 27.20 | 1 | 020-5484.0 | 1/2 |
| 115 | 6 / 13.3 | 9.20 | 1 | 020-5470.0 | 1/2 |
| 115 | 9 / 8.88 | 13.60 | 1 | 020-5471.0 | 1/2 |
| 115 | 12 / 6.67 | 18.30 | 1 | 020-5472.0 | 1/2 |
| 115 | 15 / 5.33 | 22.60 | 1 | 020-5473.0 | 1/2 |
| 115 | 18 / 4.44 | 27.20 | 1 | 020-5474.0 | 1/2 |

-  Frequency 50/60Hz
-  Potted under vacuum
-  Split-bobbin
-  Temperature class ta 70°C/B
-  Short-circuit-proof (where noted: 1/2/3* under Agency Approvals)
-  Weight: 0.018kg
-  Packaging unit: 40 pieces (tray)

Mechanical

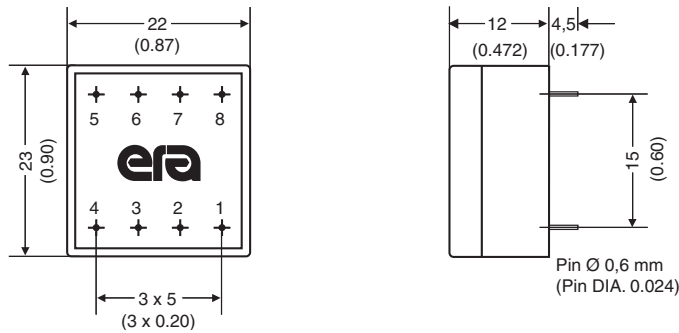

Schematic

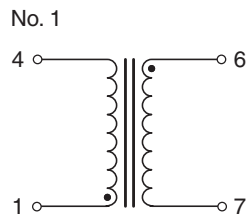



LAMINATED TRANSFORMERS

Type EE20 / 6.1 - 0.35VA









AGENCY APPROVALS 

1. UL 506, File E113449  **Class 2/3**

2. UL 1585, File E175197  **Class 2/3**

3. EN61558 

-  Frequency 50/60Hz
-  Potted under vacuum
-  Split-bobbin
-  Temperature class ta 70°C/B
-  Short-circuit-proof (where noted: 1/2/3* under Agency Approvals)
-  Weight: 0.024kg
-  Packaging unit: 40 pieces (tray)

Mechanical

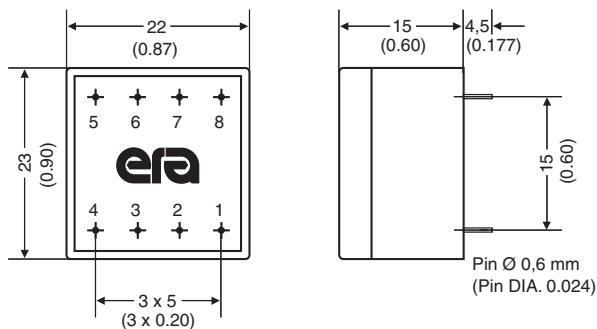

| Primary (V) | Secondary (V / mA) | No-Load Voltage (V) | Schematic No. | Part Number | Agency Approvals |
|-------------|--------------------|---------------------|---------------|-------------|------------------|
| 230 | 6 / 58.0 | 10.80 | 1 | 020-5423.0 | 1/2/3* |
| 230 | 9 / 39.0 | 16.50 | 1 | 020-5424.0 | 1/2/3* |
| 230 | 12 / 29.0 | 21.90 | 1 | 020-5425.0 | 1/2/3* |
| 230 | 15 / 23.0 | 27.00 | 1 | 020-5426.0 | 1/2/3* |
| 230 | 18 / 19.0 | 31.50 | 1 | 020-5427.0 | 1/2/3* |
| 230 | 24 / 14.0 | 41.70 | 1 | 020-5428.0 | 1/2/3* |
| 230 | 2x6 / 29.0 | 2x10.95 | 2 | 020-5429.0 | 1/2/3* |
| 230 | 2x9 / 19.0 | 2x15.60 | 2 | 020-5430.0 | 1/2/3* |
| 230 | 2x12 / 14.0 | 2x20.70 | 2 | 020-5431.0 | 1/2/3* |
| 230 | 2x15 / 12.0 | 2x26.00 | 2 | 020-5432.0 | 1 |
| 230 | 2x18 / 9.5 | 2x31.20 | 2 | 020-5433.0 | 1 |
| 230 | 2x24 / 7.0 | 2x41.90 | 2 | 020-5434.0 | 1 |
| 115 | 6 / 58.0 | 10.80 | 1 | 020-5411.0 | 1/2/3* |
| 115 | 9 / 39.0 | 16.50 | 1 | 020-5412.0 | 1/2/3* |
| 115 | 12 / 29.0 | 21.90 | 1 | 020-5413.0 | 1/2/3* |
| 115 | 15 / 23.0 | 27.00 | 1 | 020-5414.0 | 1/2/3* |
| 115 | 18 / 19.0 | 31.50 | 1 | 020-5415.0 | 1/2/3* |
| 115 | 24 / 14.0 | 41.70 | 1 | 020-5416.0 | 1/2/3* |
| 115 | 2x6 / 29.0 | 2x10.95 | 2 | 020-5417.0 | 1/2/3* |
| 115 | 2x9 / 19.0 | 2x15.60 | 2 | 020-5418.0 | 1/2/3* |
| 115 | 2x12 / 14.0 | 2x20.70 | 2 | 020-5419.0 | 1/2/3* |
| 115 | 2x15 / 12.0 | 2x26.00 | 2 | 020-5420.0 | 1 |
| 115 | 2x18 / 9.5 | 2x31.20 | 2 | 020-5421.0 | 1 |
| 115 | 2x24 / 7.0 | 2x41.90 | 2 | 020-5422.0 | 1 |

*NOTE: When checking the approval status of this product with VDE, add the prefix "BV" and the suffix "M" to the orderable Part Number (these letters will also be found on the part label). The prefix and suffix are not part of the orderable Part Number.

Schematics

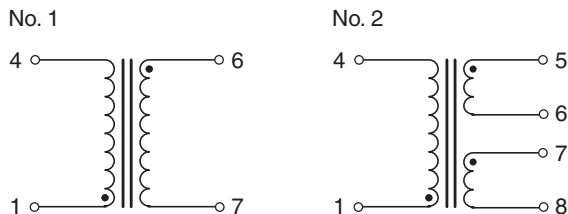

LAMINATED TRANSFORMERS

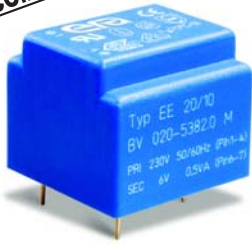

Type EE20 / 10 - 0.50VA









AGENCY APPROVALS 

1. UL 506, File E113449 

2. UL 1585, File E175197 [Class 2/3]

3. EN61558  

-  Frequency 50/60Hz
-  Potted under vacuum
-  Split-bobbin
-  Temperature class ta 70°C/B
-  Short-circuit-proof (where noted: 1/2/3* under Agency Approvals)
-  Weight: 0.035kg
-  Packaging unit: 40 pieces (tray)

| Primary (V) | Secondary (V / mA) | No-Load Voltage (V) | Schematic No. | Part Number | Agency Approvals |
|-------------|--------------------|---------------------|---------------|-------------|------------------|
| 230 | 6 / 83 | 8.90 | 1 | 020-5382.0 | 1/2/3* |
| 230 | 9 / 55 | 13.50 | 1 | 020-5383.0 | 1/2/3* |
| 230 | 12 / 42 | 19.40 | 1 | 020-5384.0 | 1/2/3* |
| 230 | 15 / 34 | 24.60 | 1 | 020-5385.0 | 1/2/3* |
| 230 | 18 / 28 | 29.50 | 1 | 020-5386.0 | 1/2/3* |
| 230 | 24 / 21 | 39.60 | 1 | 020-5387.0 | 1/2/3* |
| 230 | 2x6 / 42 | 2x9.60 | 2 | 020-5388.0 | 1/2/3* |
| 230 | 2x9 / 28 | 2x15.20 | 2 | 020-5389.0 | 1/2/3* |
| 230 | 2x12 / 21 | 2x19.10 | 2 | 020-5390.0 | 1/2/3* |
| 230 | 2x15 / 16 | 2x23.30 | 2 | 020-5391.0 | 1/2/3* |
| 230 | 2x18 / 14 | 2x29.2 | 2 | 020-5392.0 | 1 |
| 230 | 2x24 / 10 | 2x38.8 | 2 | 020-5393.0 | 1 |
| 115 | 6 / 83 | 8.90 | 1 | 020-5370.0 | 1/2/3* |
| 115 | 9 / 55 | 13.50 | 1 | 020-5371.0 | 1/2/3* |
| 115 | 12 / 42 | 19.40 | 1 | 020-5372.0 | 1/2/3* |
| 115 | 15 / 34 | 24.60 | 1 | 020-5373.0 | 1/2/3* |
| 115 | 18 / 28 | 29.50 | 1 | 020-5374.0 | 1/2/3* |
| 115 | 24 / 21 | 39.60 | 1 | 020-5375.0 | 1/2/3* |
| 115 | 2x6 / 42 | 2x9.60 | 2 | 020-5376.0 | 1/2/3* |
| 115 | 2x9 / 28 | 2x15.20 | 2 | 020-5377.0 | 1/2/3* |
| 115 | 2x12 / 21 | 2x19.10 | 2 | 020-5378.0 | 1/2/3* |
| 115 | 2x15 / 16 | 2x23.30 | 2 | 020-5379.0 | 1/2/3* |
| 115 | 2x18 / 14 | 2x29.20 | 2 | 020-5380.0 | 1 |
| 115 | 2x24 / 10 | 2x38.80 | 2 | 020-5381.0 | 1 |

Mechanical

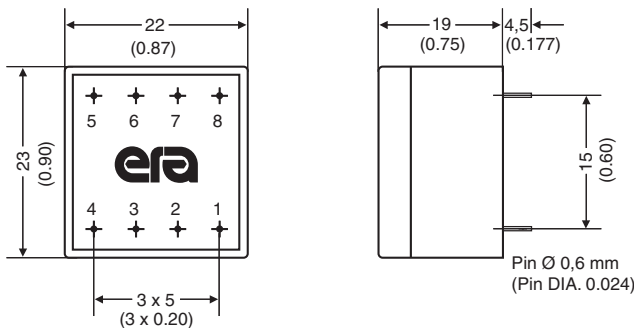

***NOTE:** When checking the approval status of this product with VDE, add the prefix "BV" and the suffix "M" to the orderable Part Number (these letters will also be found on the part label). **The prefix and suffix are not part of the orderable Part Number.**

Schematics

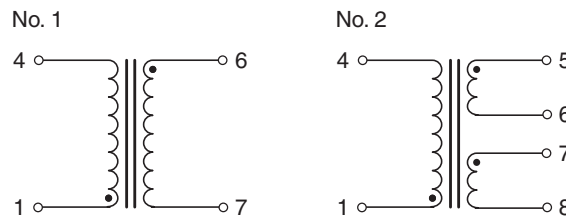

LAMINATED TRANSFORMERS

Type EI30 / 5 - 0.5VA









AGENCY APPROVALS 

1. UL 506, File E113449 

2. UL 1585, File E175197 

3. EN61558  

-  Frequency 50/60Hz
-  Potted under vacuum
-  Split-bobbin
-  Temperature class ta 70°C/B
-  Short-circuit-proof (where noted: 1/2/3* under Agency Approvals)
-  Weight: 0.06kg
-  Packaging unit: 25 pieces (tube)

Mechanical

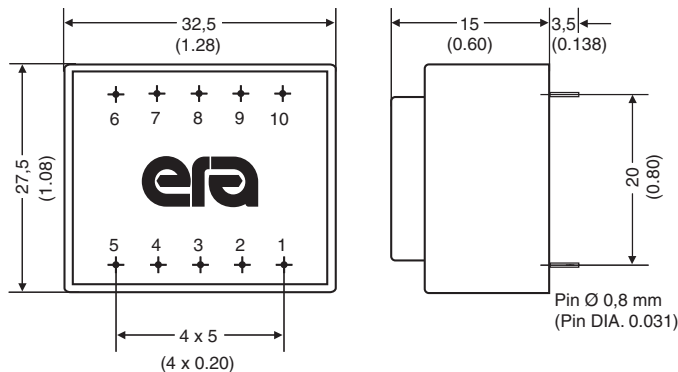

Schematics

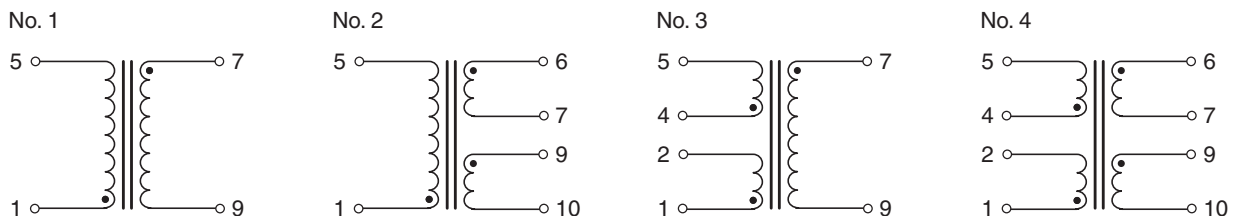

| Primary (V) | Secondary (V / mA) | No-Load Voltage (V) | Schematic No. | Part Number | Agency Approvals |
|-------------|--------------------|---------------------|---------------|-------------|------------------|
| 230 | 6 / 83 | 10.40 | 1 | 030-7196.0 | 1/2/3* |
| 230 | 9 / 55 | 15.60 | 1 | 030-7197.0 | 1/2/3* |
| 230 | 12 / 42 | 20.80 | 1 | 030-7198.0 | 1/2/3* |
| 230 | 15 / 33 | 25.40 | 1 | 030-7199.0 | 1/2/3* |
| 230 | 18 / 28 | 29.50 | 1 | 030-7200.0 | 1/2/3* |
| 230 | 24 / 20 | 38.10 | 1 | 030-7201.0 | 1/2/3* |
| 230 | 2x6 / 42 | 2x10.60 | 2 | 030-7202.0 | 1/2/3* |
| 230 | 2x9 / 28 | 2x15.50 | 2 | 030-7203.0 | 1/2/3* |
| 230 | 2x12 / 20 | 2x19.70 | 2 | 030-7204.0 | 1/2/3* |
| 230 | 2x15 / 16 | 2x24.80 | 2 | 030-7205.0 | 1/2/3* |
| 230 | 2x18 / 13 | 2x29.80 | 2 | 030-7206.0 | 1 |
| 230 | 2x24 / 10 | 2x39.10 | 2 | 030-7207.0 | 1 |
| 115 | 6 / 83 | 10.40 | 1 | 030-7184.0 | 1/2/3* |
| 115 | 9 / 55 | 15.60 | 1 | 030-7185.0 | 1/2/3* |
| 115 | 12 / 42 | 20.80 | 1 | 030-7186.0 | 1/2/3* |
| 115 | 15 / 33 | 25.40 | 1 | 030-7187.0 | 1/2/3* |
| 115 | 18 / 28 | 29.50 | 1 | 030-7188.0 | 1/2/3* |
| 115 | 24 / 20 | 38.10 | 1 | 030-7189.0 | 1/2/3* |
| 115 | 2x6 / 42 | 2x10.60 | 2 | 030-7190.0 | 1/2/3* |
| 115 | 2x9 / 28 | 2x15.50 | 2 | 030-7191.0 | 1/2/3* |
| 115 | 2x12 / 20 | 2x19.70 | 2 | 030-7192.0 | 1/2/3* |
| 115 | 2x15 / 16 | 2x24.80 | 2 | 030-7193.0 | 1/2/3* |
| 115 | 2x18 / 13 | 2x29.80 | 2 | 030-7194.0 | 1 |
| 115 | 2x24 / 10 | 2x39.10 | 2 | 030-7195.0 | 1 |
| 2x115 | 6 / 83 | 10.40 | 3 | 030-5325.0 | 1/2/3* |
| 2x115 | 9 / 55 | 15.60 | 3 | 030-5328.0 | 1/2/3* |
| 2x115 | 12 / 42 | 20.80 | 3 | 030-5331.0 | 1/2/3* |
| 2x115 | 15 / 33 | 25.40 | 3 | 030-5334.0 | 1/2/3* |
| 2x115 | 18 / 28 | 29.50 | 3 | 030-5337.0 | 1/2/3* |
| 2x115 | 24 / 20 | 38.10 | 3 | 030-5343.0 | 1/2/3* |
| 2x115 | 2x6 / 42 | 2x10.60 | 4 | 030-5348.0 | 1/2/3* |
| 2x115 | 2x9 / 28 | 2x15.50 | 4 | 030-5351.0 | 1/2/3* |
| 2x115 | 2x12 / 20 | 2x19.70 | 4 | 030-5354.0 | 1/2/3* |
| 2x115 | 2x15 / 16 | 2x24.80 | 4 | 030-5357.0 | 1/2/3* |
| 2x115 | 2x18 / 13 | 2x29.80 | 4 | 030-5360.0 | 1 |
| 2x115 | 2x24 / 10 | 2x39.10 | 4 | 030-5366.0 | 1 |

*NOTE: When checking the approval status of this product with VDE, add the prefix "BV" and the suffix "P" to the orderable Part Number (these letters will also be found on the part label). The prefix and suffix are not part of the orderable Part Number.

LAMINATED TRANSFORMERS



Type EI30 / 10.5 - 1.0VA









AGENCY APPROVALS 

1. UL 506, File E113449 

2. UL 1585, File E175197  Class 2/3

3. EN61558  

-  Frequency 50/60Hz
-  Potted under vacuum
-  Split-bobbin
-  Temperature class ta 70°C/B
-  Short-circuit-proof (where noted: 1/2/3* under Agency Approvals)
-  Weight: 0.07kg
-  Packaging unit: 35 pieces (tray)
25 pieces (tube)

| Primary (V) | Secondary (V / mA) | No-Load Voltage (V) | Schematic No. | Part Number | Agency Approvals |
|-------------|--------------------|---------------------|---------------|-------------|------------------|
| 230 | 6 / 166 | 8.50 | 1 | 030-7232.0 | 1/2/3* |
| 230 | 9 / 111 | 12.45 | 1 | 030-7233.0 | 1/2/3* |
| 230 | 12 / 84 | 16.30 | 1 | 030-7234.0 | 1/2/3* |
| 230 | 15 / 66 | 20.20 | 1 | 030-7235.0 | 1/2/3* |
| 230 | 18 / 55 | 24.20 | 1 | 030-7236.0 | 1/2/3* |
| 230 | 24 / 42 | 32.20 | 1 | 030-7237.0 | 1/2/3* |
| 230 | 2x6 / 84 | 2x8.30 | 2 | 030-7238.0 | 1/2/3* |
| 230 | 2x9 / 55 | 2x11.90 | 2 | 030-7239.0 | 1/2/3* |
| 230 | 2x12 / 42 | 2x16.20 | 2 | 030-7240.0 | 1/2/3* |
| 230 | 2x15 / 33 | 2x20.40 | 2 | 030-7241.0 | 1/2/3* |
| 230 | 2x18 / 28 | 2x24.20 | 2 | 030-7242.0 | 1 |
| 230 | 2x24 / 21 | 2x32.10 | 2 | 030-7243.0 | 1 |
| 115 | 6 / 166 | 8.50 | 1 | 030-7220.0 | 1/2/3* |
| 115 | 9 / 111 | 12.45 | 1 | 030-7221.0 | 1/2/3* |
| 115 | 12 / 84 | 16.30 | 1 | 030-7222.0 | 1/2/3* |
| 115 | 15 / 66 | 20.20 | 1 | 030-7223.0 | 1/2/3* |
| 115 | 18 / 55 | 24.20 | 1 | 030-7224.0 | 1/2/3* |
| 115 | 24 / 42 | 32.20 | 1 | 030-7225.0 | 1/2/3* |
| 115 | 2x6 / 84 | 2x8.30 | 2 | 030-7226.0 | 1/2/3* |
| 115 | 2x9 / 55 | 2x11.90 | 2 | 030-7227.0 | 1/2/3* |
| 115 | 2x12 / 42 | 2x16.20 | 2 | 030-7228.0 | 1/2/3* |
| 115 | 2x15 / 33 | 2x20.40 | 2 | 030-7229.0 | 1/2/3* |
| 115 | 2x18 / 28 | 2x24.20 | 2 | 030-7230.0 | 1 |
| 115 | 2x24 / 21 | 2x32.10 | 2 | 030-7231.0 | 1 |
| 2x115 | 6 / 166 | 8.50 | 3 | 030-5693.0 | 1/2/3* |
| 2x115 | 9 / 111 | 12.45 | 3 | 030-5696.0 | 1/2/3* |
| 2x115 | 12 / 84 | 16.30 | 3 | 030-5699.0 | 1/2/3* |
| 2x115 | 15 / 66 | 20.20 | 3 | 030-5702.0 | 1/2/3* |
| 2x115 | 18 / 55 | 24.20 | 3 | 030-5705.0 | 1/2/3* |
| 2x115 | 24 / 42 | 32.20 | 3 | 030-5711.0 | 1/2/3* |
| 2x115 | 2x6 / 84 | 2x8.30 | 4 | 030-5716.0 | 1/2/3* |
| 2x115 | 2x9 / 55 | 2x11.90 | 4 | 030-5719.0 | 1/2/3* |
| 2x115 | 2x12 / 42 | 2x16.20 | 4 | 030-5722.0 | 1/2/3* |
| 2x115 | 2x15 / 33 | 2x20.40 | 4 | 030-5725.0 | 1/2/3* |
| 2x115 | 2x18 / 28 | 2x24.20 | 4 | 030-5728.0 | 1 |
| 2x115 | 2x24 / 21 | 2x32.10 | 4 | 030-5734.0 | 1 |

Mechanical

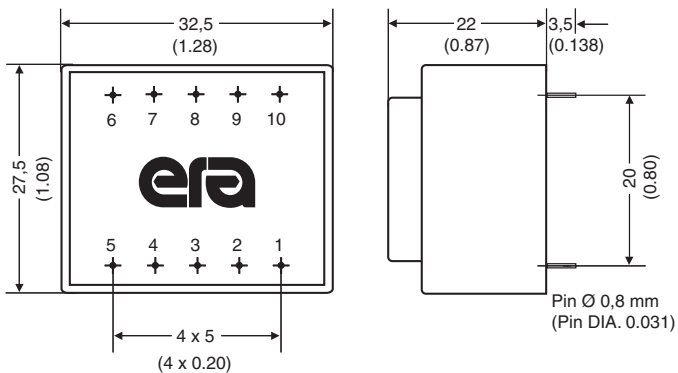

Schematics

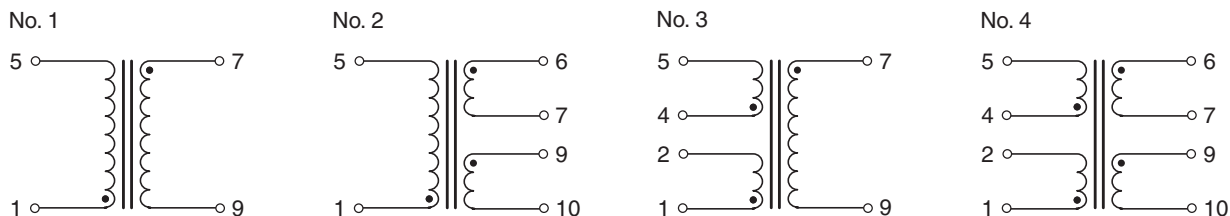



*NOTE: When checking the approval status of this product with VDE, add the prefix "BV" and the suffix "R" to the orderable Part Number (these letters will also be found on the part label). The prefix and suffix are not part of the orderable Part Number.

LAMINATED TRANSFORMERS



Type EI30 / 12.5 - 1.2VA









AGENCY APPROVALS 

1. UL 506, File E113449 

2. UL 1585, File E175197 [Class 2/3] 

3. EN61558  

-  Frequency 50/60Hz
-  Potted under vacuum
-  Split-bobbin
-  Temperature class ta 70°C/B
-  Short-circuit-proof (where noted: 1/2/3* under Agency Approvals)
-  Weight: 0.08kg
-  Packaging unit: 25 pieces (tube)

Mechanical

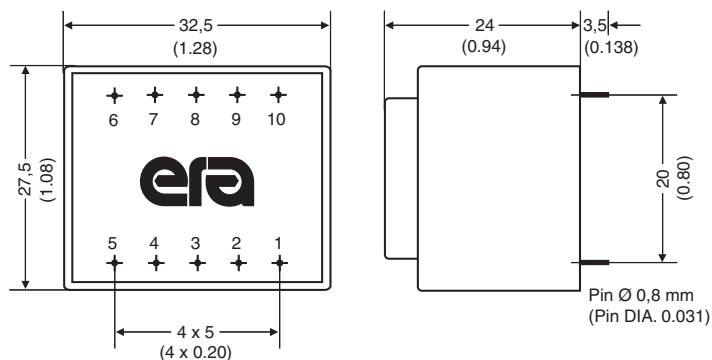

Schematics

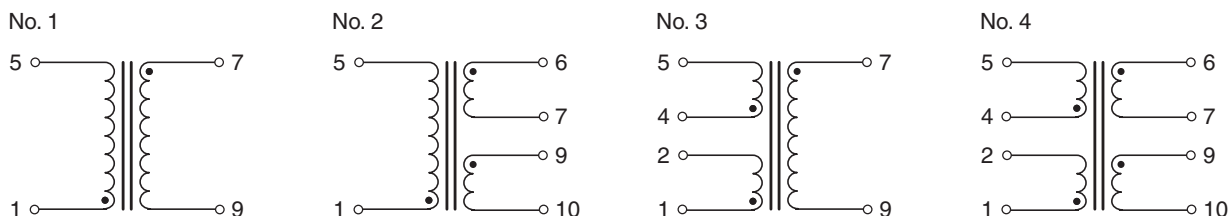

| Primary (V) | Secondary (V / mA) | No-Load Voltage (V) | Schematic No. | Part Number | Agency Approvals |
|-------------|--------------------|---------------------|---------------|-------------|------------------|
| 230 | 6 / 200 | 8.70 | 1 | 030-7268.0 | 1/2/3* |
| 230 | 9 / 133 | 12.30 | 1 | 030-7269.0 | 1/2/3* |
| 230 | 12 / 100 | 16.60 | 1 | 030-7270.0 | 1/2/3* |
| 230 | 15 / 80 | 21.20 | 1 | 030-7271.0 | 1/2/3* |
| 230 | 18 / 66 | 27.80 | 1 | 030-7272.0 | 1/2/3* |
| 230 | 24 / 50 | 34.50 | 1 | 030-7273.0 | 1/2/3* |
| 230 | 2x6 / 100 | 2x8.70 | 2 | 030-7274.0 | 1/2/3* |
| 230 | 2x9 / 66 | 2x12.30 | 2 | 030-7275.0 | 1/2/3* |
| 230 | 2x12 / 50 | 2x16.60 | 2 | 030-7276.0 | 1/2/3* |
| 230 | 2x15 / 40 | 2x20.60 | 2 | 030-7277.0 | 1/2/3* |
| 230 | 2x18 / 33 | 2x25.80 | 2 | 030-7278.0 | 1 |
| 230 | 2x24 / 25 | 2x32.90 | 2 | 030-7279.0 | 1 |
| 115 | 6 / 200 | 8.70 | 1 | 030-7256.0 | 1/2/3* |
| 115 | 9 / 133 | 12.30 | 1 | 030-7257.0 | 1/2/3* |
| 115 | 12 / 100 | 16.60 | 1 | 030-7258.0 | 1/2/3* |
| 115 | 15 / 80 | 21.20 | 1 | 030-7259.0 | 1/2/3* |
| 115 | 18 / 66 | 27.80 | 1 | 030-7260.0 | 1/2/3* |
| 115 | 24 / 50 | 34.50 | 1 | 030-7261.0 | 1/2/3* |
| 115 | 2x6 / 100 | 2x8.70 | 2 | 030-7262.0 | 1/2/3* |
| 115 | 2x9 / 66 | 2x12.30 | 2 | 030-7263.0 | 1/2/3* |
| 115 | 2x12 / 50 | 2x16.60 | 2 | 030-7264.0 | 1/2/3* |
| 115 | 2x15 / 40 | 2x20.60 | 2 | 030-7265.0 | 1/2/3* |
| 115 | 2x18 / 33 | 2x25.80 | 2 | 030-7266.0 | 1 |
| 115 | 2x24 / 25 | 2x32.90 | 2 | 030-7267.0 | 1 |
| 2x115 | 6 / 200 | 8.95 | 3 | 030-6061.0 | 1/2/3* |
| 2x115 | 9 / 133 | 12.90 | 3 | 030-6064.0 | 1/2/3* |
| 2x115 | 12 / 100 | 16.70 | 3 | 030-6067.0 | 1/2/3* |
| 2x115 | 15 / 80 | 24.70 | 3 | 030-6070.0 | 1/2/3* |
| 2x115 | 18 / 66 | 29.50 | 3 | 030-6073.0 | 1/2/3* |
| 2x115 | 24 / 50 | 35.80 | 3 | 030-6079.0 | 1/2/3* |
| 2x115 | 2x6 / 100 | 2x9.15 | 4 | 030-6084.0 | 1/2/3* |
| 2x115 | 2x9 / 66 | 2x13.70 | 4 | 030-6087.0 | 1/2/3* |
| 2x115 | 2x12 / 50 | 2x17.30 | 4 | 030-6090.0 | 1/2/3* |
| 2x115 | 2x15 / 40 | 2x24.70 | 4 | 030-6093.0 | 1/2/3* |
| 2x115 | 2x18 / 33 | 2x29.40 | 4 | 030-6096.0 | 1 |
| 2x115 | 2x24 / 25 | 2x35.80 | 4 | 030-6102.0 | 1 |

*NOTE: When checking the approval status of this product with VDE, add the prefix "BV" and the suffix "V" to the orderable Part Number (these letters will also be found on the part label). The prefix and suffix are not part of the orderable Part Number.

LAMINATED TRANSFORMERS

Type EI30 / 12.5 - 1.5VA









AGENCY APPROVALS 

1. UL 506, File E113449 

2. UL 1585, File E175197  Class 2/3

3. EN61558 

-  Frequency 50/60Hz
-  Potted under vacuum
-  Split-bobbin
-  Temperature class ta 70°C/B
-  Short-circuit-proof (where noted: 1/2/3* under Agency Approvals)
-  Weight: 0.08kg
-  Packaging unit: 25 pieces (tube)

Mechanical

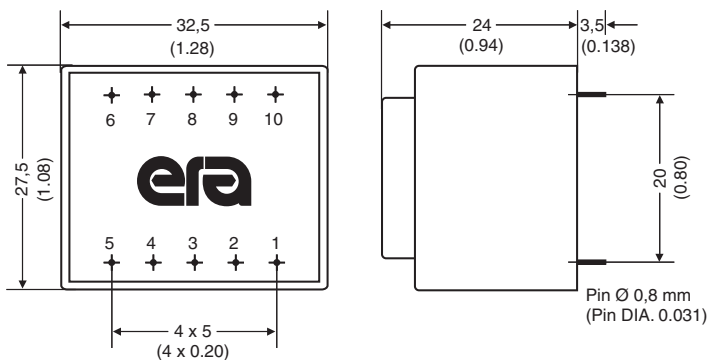

Schematics

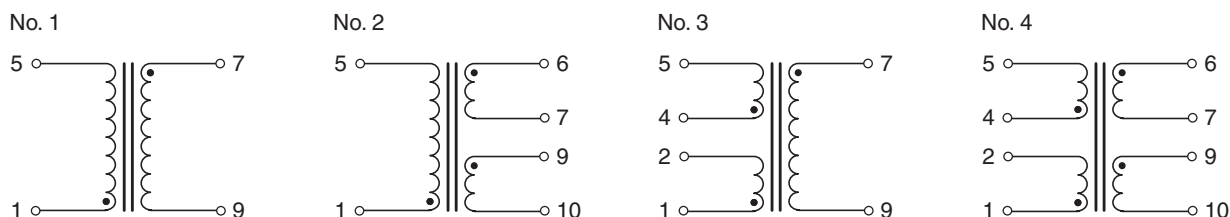

| Primary (V) | Secondary (V / mA) | No-Load Voltage (V) | Schematic No. | Part Number | Agency Approvals |
|-------------|--------------------|---------------------|---------------|-------------|------------------|
| 230 | 6 / 250 | 8.95 | 1 | 030-7161.0 | 1/2/3* |
| 230 | 9 / 166 | 12.90 | 1 | 030-7162.0 | 1/2/3* |
| 230 | 12 / 125 | 16.70 | 1 | 030-7139.0 | 1/2/3* |
| 230 | 15 / 100 | 24.70 | 1 | 030-7163.0 | 1/2/3* |
| 230 | 18 / 83 | 29.50 | 1 | 030-7164.0 | 1/2/3* |
| 230 | 24 / 62 | 35.80 | 1 | 030-7165.0 | 1/2/3* |
| 230 | 2x6 / 125 | 2x9.15 | 2 | 030-7166.0 | 1/2/3* |
| 230 | 2x9 / 83 | 2x13.70 | 2 | 030-7167.0 | 1/2/3* |
| 230 | 2x12 / 62 | 2x17.30 | 2 | 030-7168.0 | 1/2/3* |
| 230 | 2x15 / 50 | 2x24.70 | 2 | 030-7169.0 | 1/2/3* |
| 230 | 2x18 / 41 | 2x29.40 | 2 | 030-7170.0 | 1 |
| 230 | 2x24 / 31 | 2x35.80 | 2 | 030-7171.0 | 1 |
| 115 | 6 / 250 | 8.95 | 1 | 030-7150.0 | 1/2/3* |
| 115 | 9 / 166 | 12.90 | 1 | 030-7151.0 | 1/2/3* |
| 115 | 12 / 125 | 16.70 | 1 | 030-7136.0 | 1/2/3* |
| 115 | 15 / 100 | 24.70 | 1 | 030-7152.0 | 1/2/3* |
| 115 | 18 / 83 | 29.50 | 1 | 030-7153.0 | 1/2/3* |
| 115 | 24 / 62 | 35.80 | 1 | 030-7154.0 | 1/2/3* |
| 115 | 2x6 / 125 | 2x9.15 | 2 | 030-7155.0 | 1/2/3* |
| 115 | 2x9 / 83 | 2x13.70 | 2 | 030-7156.0 | 1/2/3* |
| 115 | 2x12 / 62 | 2x17.30 | 2 | 030-7157.0 | 1/2/3* |
| 115 | 2x15 / 50 | 2x24.70 | 2 | 030-7158.0 | 1/2/3* |
| 115 | 2x18 / 41 | 2x29.40 | 2 | 030-7159.0 | 1 |
| 115 | 2x24 / 31 | 2x35.80 | 2 | 030-7160.0 | 1 |
| 2x115 | 6 / 250 | 8.95 | 3 | 030-7711.0 | 1/2/3* |
| 2x115 | 9 / 166 | 12.90 | 3 | 030-7712.0 | 1/2/3* |
| 2x115 | 12 / 125 | 16.70 | 3 | 030-7713.0 | 1/2/3* |
| 2x115 | 15 / 100 | 24.70 | 3 | 030-7714.0 | 1/2/3* |
| 2x115 | 18 / 83 | 29.50 | 3 | 030-7715.0 | 1/2/3* |
| 2x115 | 24 / 62 | 35.80 | 3 | 030-7716.0 | 1/2/3* |
| 2x115 | 2x6 / 125 | 2x9.15 | 4 | 030-7717.0 | 1/2/3* |
| 2x115 | 2x9 / 83 | 2x13.70 | 4 | 030-7718.0 | 1/2/3* |
| 2x115 | 2x12 / 62 | 2x17.30 | 4 | 030-7719.0 | 1/2/3* |
| 2x115 | 2x15 / 50 | 2x24.70 | 4 | 030-7720.0 | 1/2/3* |
| 2x115 | 2x18 / 41 | 2x29.40 | 4 | 030-7721.0 | 1 |
| 2x115 | 2x24 / 31 | 2x35.80 | 4 | 030-7722.0 | 1 |

*NOTE: When checking the approval status of this product with VDE, add the prefix "BV" and the suffix "N" to the orderable Part Number (these letters will also be found on the part label). The prefix and suffix are not part of the orderable Part Number.

LAMINATED TRANSFORMERS

Type EI30 / 15.5 - 2.0VA



- ⦿ Frequency 50/60Hz
- ⦿ Potted under vacuum
- ⦿ Split-bobbin
- ⦿ Temperature class ta 70°C/B
- ⦿ Weight: 0.10kg
- ⦿ Packaging unit: 25 pieces (tube)

Mechanical

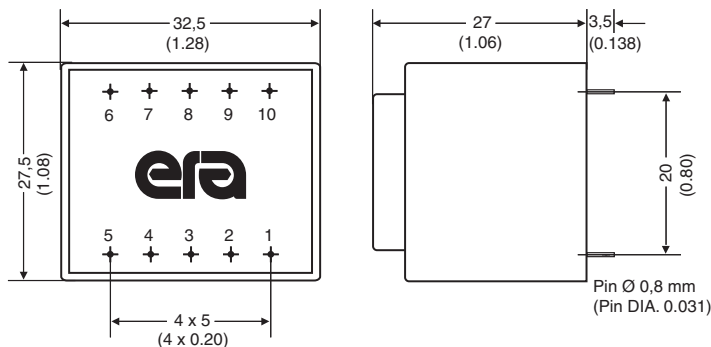

Schematics

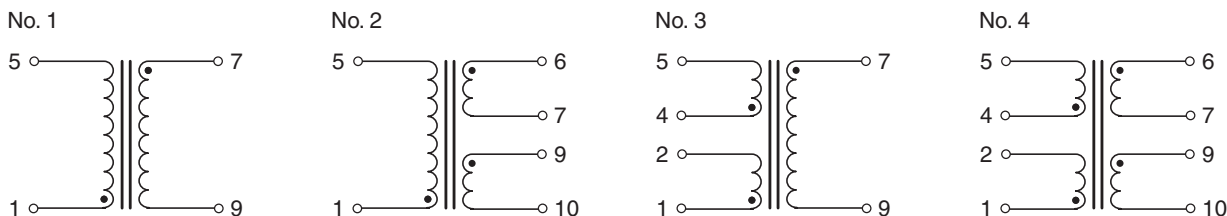

| Primary (V) | Secondary (V / mA) | No-Load Voltage (V) | Schematic No. | Part Number | Agency Approvals |
|-------------|--------------------|---------------------|---------------|-------------|------------------|
| 230 | 6 / 333 | 10.50 | 1 | 030-7304.0 | 1/3* |
| 230 | 9 / 222 | 14.60 | 1 | 030-7305.0 | 1/3* |
| 230 | 12 / 166 | 20.00 | 1 | 030-7306.0 | 1/3* |
| 230 | 15 / 133 | 26.00 | 1 | 030-7307.0 | 1/3* |
| 230 | 18 / 111 | 29.60 | 1 | 030-7308.0 | 1/3* |
| 230 | 24 / 83 | 37.20 | 1 | 030-7309.0 | 1/3* |
| 230 | 2x6 / 166 | 2x8.70 | 2 | 030-7310.0 | 1/3* |
| 230 | 2x9 / 111 | 2x14.60 | 2 | 030-7311.0 | 1/3* |
| 230 | 2x12 / 83 | 2x19.45 | 2 | 030-7312.0 | 1/3* |
| 230 | 2x15 / 66 | 2x24.10 | 2 | 030-7313.0 | 1/3* |
| 230 | 2x18 / 55 | 2x29.10 | 2 | 030-7314.0 | 1 |
| 230 | 2x24 / 42 | 2x36.50 | 2 | 030-7315.0 | 1 |
| 115 | 6 / 333 | 10.50 | 1 | 030-7292.0 | 1/3* |
| 115 | 9 / 222 | 14.60 | 1 | 030-7293.0 | 1/3* |
| 115 | 12 / 166 | 20.00 | 1 | 030-7294.0 | 1/3* |
| 115 | 15 / 133 | 26.00 | 1 | 030-7295.0 | 1/3* |
| 115 | 18 / 111 | 29.60 | 1 | 030-7296.0 | 1/3* |
| 115 | 24 / 83 | 37.20 | 1 | 030-7297.0 | 1/3* |
| 115 | 2x6 / 166 | 2x8.70 | 2 | 030-7298.0 | 1/3* |
| 115 | 2x9 / 111 | 2x14.60 | 2 | 030-7299.0 | 1/3* |
| 115 | 2x12 / 83 | 2x19.45 | 2 | 030-7300.0 | 1/3* |
| 115 | 2x15 / 66 | 2x24.10 | 2 | 030-7301.0 | 1/3* |
| 115 | 2x18 / 55 | 2x29.10 | 2 | 030-7302.0 | 1 |
| 115 | 2x24 / 42 | 2x36.50 | 2 | 030-7303.0 | 1 |
| 2x115 | 6 / 333 | 10.50 | 3 | 030-6429.0 | 1/3* |
| 2x115 | 9 / 222 | 14.60 | 3 | 030-6432.0 | 1/3* |
| 2x115 | 12 / 166 | 20.00 | 3 | 030-6435.0 | 1/3* |
| 2x115 | 15 / 133 | 26.00 | 3 | 030-6438.0 | 1/3* |
| 2x115 | 18 / 111 | 29.60 | 3 | 030-6441.0 | 1/3* |
| 2x115 | 24 / 83 | 37.20 | 3 | 030-6447.0 | 1/3* |
| 2x115 | 2x6 / 166 | 2x8.70 | 4 | 030-6452.0 | 1/3* |
| 2x115 | 2x9 / 111 | 2x14.60 | 4 | 030-6455.0 | 1/3* |
| 2x115 | 2x12 / 83 | 2x19.45 | 4 | 030-6458.0 | 1/3* |
| 2x115 | 2x15 / 66 | 2x24.10 | 4 | 030-6461.0 | 1/3* |
| 2x115 | 2x18 / 55 | 2x29.10 | 4 | 030-6464.0 | 1 |
| 2x115 | 2x24 / 42 | 2x36.50 | 4 | 030-6470.0 | 1 |

*NOTE: When checking the approval status of this product with VDE, add the prefix "BV" and the suffix "S" to the orderable Part Number (these letters will also be found on the part label). The prefix and suffix are **not** part of the orderable Part Number.

LAMINATED TRANSFORMERS







Type EI30 / 18.0 - 2.3VA



AGENCY APPROVALS 

1. UL 506, File E113449 

3. EN61558  

-  Frequency 50/60Hz
-  Potted under vacuum
-  Split-bobbin
-  Temperature class ta 70°C/B
-  Weight: 0.112kg
-  Packaging unit: 25 pieces (tube)

Mechanical

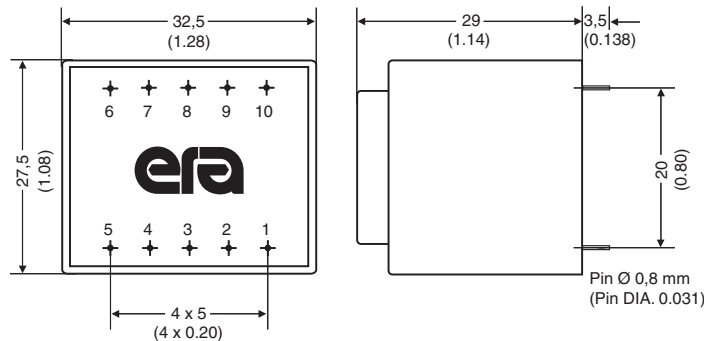

Schematics

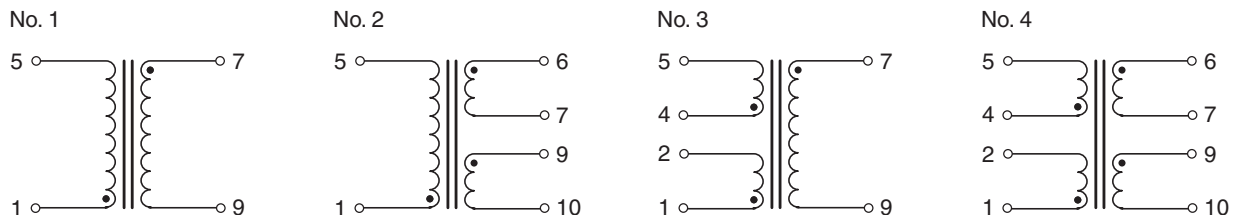

| Primary (V) | Secondary (V / mA) | No-Load Voltage (V) | Schematic No. | Part Number | Agency Approvals |
|-------------|--------------------|---------------------|---------------|-------------|------------------|
| 230 | 6 / 384 | 10.00 | 1 | 030-7340.0 | 1/3* |
| 230 | 9 / 256 | 13.80 | 1 | 030-7341.0 | 1/3* |
| 230 | 12 / 192 | 18.60 | 1 | 030-7342.0 | 1/3* |
| 230 | 15 / 154 | 23.80 | 1 | 030-7343.0 | 1/3* |
| 230 | 18 / 128 | 27.80 | 1 | 030-7344.0 | 1/3* |
| 230 | 24 / 96 | 34.70 | 1 | 030-7345.0 | 1/3* |
| 230 | 2x6 / 192 | 2x9.90 | 2 | 030-7346.0 | 1/3* |
| 230 | 2x9 / 128 | 2x14.00 | 2 | 030-7347.0 | 1/3* |
| 230 | 2x12 / 96 | 2x17.50 | 2 | 030-7348.0 | 1/3* |
| 230 | 2x15 / 77 | 2x24.40 | 2 | 030-7349.0 | 1/3* |
| 230 | 2x18 / 64 | 2x29.30 | 2 | 030-7350.0 | 1 |
| 230 | 2x24 / 48 | 2x35.80 | 2 | 030-7351.0 | 1 |
| 115 | 6 / 384 | 10.00 | 1 | 030-7328.0 | 1/3* |
| 115 | 9 / 256 | 13.80 | 1 | 030-7329.0 | 1/3* |
| 115 | 12 / 192 | 18.60 | 1 | 030-7330.0 | 1/3* |
| 115 | 15 / 154 | 23.80 | 1 | 030-7331.0 | 1/3* |
| 115 | 18 / 128 | 27.80 | 1 | 030-7332.0 | 1/3* |
| 115 | 24 / 96 | 34.70 | 1 | 030-7333.0 | 1/3* |
| 115 | 2x6 / 192 | 2x9.90 | 2 | 030-7334.0 | 1/3* |
| 115 | 2x9 / 128 | 2x14.00 | 2 | 030-7335.0 | 1/3* |
| 115 | 2x12 / 96 | 2x17.50 | 2 | 030-7336.0 | 1/3* |
| 115 | 2x15 / 77 | 2x24.40 | 2 | 030-7337.0 | 1/3* |
| 115 | 2x18 / 64 | 2x29.30 | 2 | 030-7338.0 | 1 |
| 115 | 2x24 / 48 | 2x35.80 | 2 | 030-7339.0 | 1 |
| 2x115 | 6 / 384 | 10.00 | 3 | 030-6797.0 | 1/3* |
| 2x115 | 9 / 256 | 13.80 | 3 | 030-6800.0 | 1/3* |
| 2x115 | 12 / 192 | 18.60 | 3 | 030-6803.0 | 1/3* |
| 2x115 | 15 / 154 | 23.80 | 3 | 030-6806.0 | 1/3* |
| 2x115 | 18 / 128 | 27.80 | 3 | 030-6809.0 | 1/3* |
| 2x115 | 24 / 96 | 34.70 | 3 | 030-6815.0 | 1/3* |
| 2x115 | 2x6 / 192 | 2x9.90 | 4 | 030-6820.0 | 1/3* |
| 2x115 | 2x9 / 128 | 2x14.00 | 4 | 030-6823.0 | 1/3* |
| 2x115 | 2x12 / 96 | 2x17.50 | 4 | 030-6826.0 | 1/3* |
| 2x115 | 2x15 / 77 | 2x24.40 | 4 | 030-6829.0 | 1/3* |
| 2x115 | 2x18 / 64 | 2x29.30 | 4 | 030-6832.0 | 1 |
| 2x115 | 2x24 / 48 | 2x35.80 | 4 | 030-6838.0 | 1 |







*NOTE: When checking the approval status of this product with VDE, add the prefix "BV" and the suffix "T" to the orderable Part Number (these letters will also be found on the part label). The prefix and suffix are not part of the orderable Part Number.

LAMINATED TRANSFORMERS

Type EI30 / 23.0 - 2.8VA



AGENCY APPROVALS 
 1. UL 506, File E113449 
 3. EN61558 

-  Frequency 50/60Hz
-  Potted under vacuum
-  Split-bobbin
-  Temperature class ta 70°C/B
-  Weight: 0.134kg
-  Packaging unit: 25 pieces (tube)

Mechanical

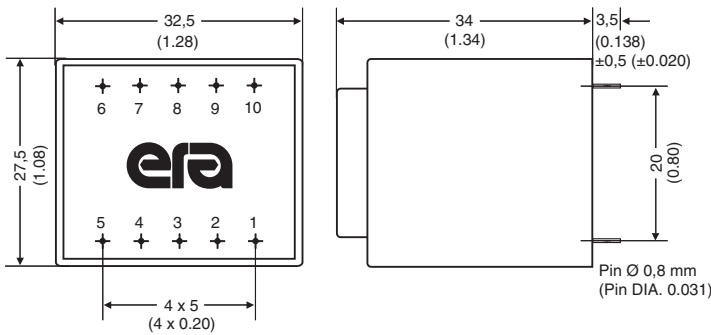

Schematics

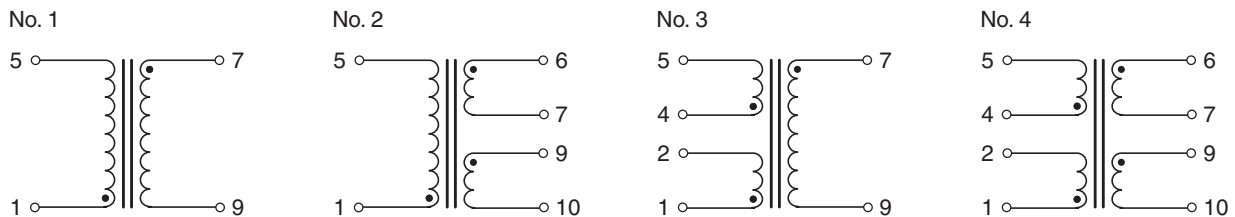

| Primary (V) | Secondary (V / mA) | No-Load Voltage (V) | Schematic No. | Part Number | Agency Approvals |
|-------------|--------------------|---------------------|---------------|-------------|------------------|
| 230 | 6 / 466 | 10.70 | 1 | 030-7584.0 | 1/3* |
| 230 | 9 / 311 | 14.80 | 1 | 030-7585.0 | 1/3* |
| 230 | 12 / 233 | 20.80 | 1 | 030-7586.0 | 1/3* |
| 230 | 15 / 186 | 24.00 | 1 | 030-7587.0 | 1/3* |
| 230 | 18 / 155 | 29.90 | 1 | 030-7588.0 | 1/3* |
| 230 | 24 / 116 | 38.80 | 1 | 030-7589.0 | 1/3* |
| 230 | 2x6 / 233 | 2x10.70 | 2 | 030-7590.0 | 1/3* |
| 230 | 2x9 / 155 | 2x16.00 | 2 | 030-7591.0 | 1/3* |
| 230 | 2x12 / 116 | 2x20.40 | 2 | 030-7592.0 | 1/3* |
| 230 | 2x15 / 93 | 2x25.00 | 2 | 030-7593.0 | 1/3* |
| 230 | 2x18 / 77 | 2x30.50 | 2 | 030-7594.0 | 1 |
| 230 | 2x24 / 58 | 2x38.70 | 2 | 030-7595.0 | 1 |
| 115 | 6 / 466 | 10.70 | 1 | 030-7596.0 | 1/3* |
| 115 | 9 / 311 | 14.80 | 1 | 030-7597.0 | 1/3* |
| 115 | 12 / 233 | 20.80 | 1 | 030-7598.0 | 1/3* |
| 115 | 15 / 186 | 24.00 | 1 | 030-7599.0 | 1/3* |
| 115 | 18 / 155 | 29.90 | 1 | 030-7600.0 | 1/3* |
| 115 | 24 / 116 | 38.80 | 1 | 030-7601.0 | 1/3* |
| 115 | 2x6 / 233 | 2x10.70 | 2 | 030-7602.0 | 1/3* |
| 115 | 2x9 / 155 | 2x16.00 | 2 | 030-7603.0 | 1/3* |
| 115 | 2x12 / 116 | 2x20.40 | 2 | 030-7604.0 | 1/3* |
| 115 | 2x15 / 93 | 2x25.00 | 2 | 030-7605.0 | 1/3* |
| 115 | 2x18 / 77 | 2x30.50 | 2 | 030-7606.0 | 1 |
| 115 | 2x24 / 58 | 2x38.70 | 2 | 030-7607.0 | 1 |
| 2x115 | 6 / 466 | 10.70 | 3 | 030-7723.0 | 1/3* |
| 2x115 | 9 / 311 | 14.80 | 3 | 030-7724.0 | 1/3* |
| 2x115 | 12 / 233 | 20.80 | 3 | 030-7725.0 | 1/3* |
| 2x115 | 15 / 186 | 24.00 | 3 | 030-7726.0 | 1/3* |
| 2x115 | 18 / 155 | 29.90 | 3 | 030-7727.0 | 1/3* |
| 2x115 | 24 / 116 | 38.80 | 3 | 030-7728.0 | 1/3* |
| 2x115 | 2x6 / 233 | 2x10.70 | 4 | 030-7729.0 | 1/3* |
| 2x115 | 2x9 / 155 | 2x16.00 | 4 | 030-7730.0 | 1/3* |
| 2x115 | 2x12 / 116 | 2x20.40 | 4 | 030-7731.0 | 1/3* |
| 2x115 | 2x15 / 93 | 2x25.00 | 4 | 030-7732.0 | 1/3* |
| 2x115 | 2x18 / 77 | 2x30.50 | 4 | 030-7733.0 | 1 |
| 2x115 | 2x24 / 58 | 2x38.70 | 4 | 030-7734.0 | 1 |

*NOTE: When checking the approval status of this product with VDE, add the prefix "BV" and the suffix "U" to the orderable Part Number (these letters will also be found on the part label). The prefix and suffix are **not** part of the orderable Part Number.

LAMINATED TRANSFORMERS







Type EI38 / 13.6 - 3.2VA



AGENCY APPROVALS 

1. UL 506, File E113449  

3. EN61558  

-  Frequency 50/60Hz
-  Potted under vacuum
-  Split-bobbin
-  Temperature class ta 70°C/B
-  Weight: 0.155kg
-  Packaging unit: 25 pieces (tray)

Mechanical

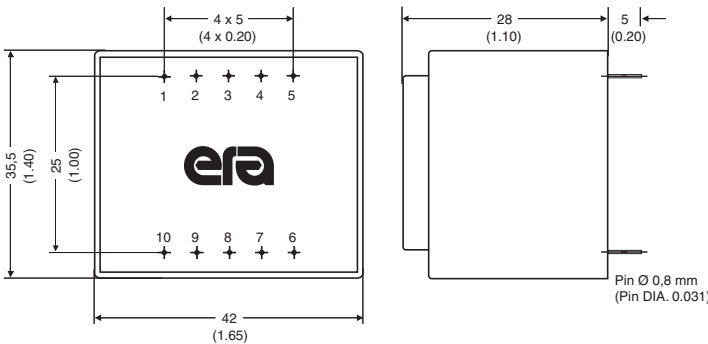

Schematics

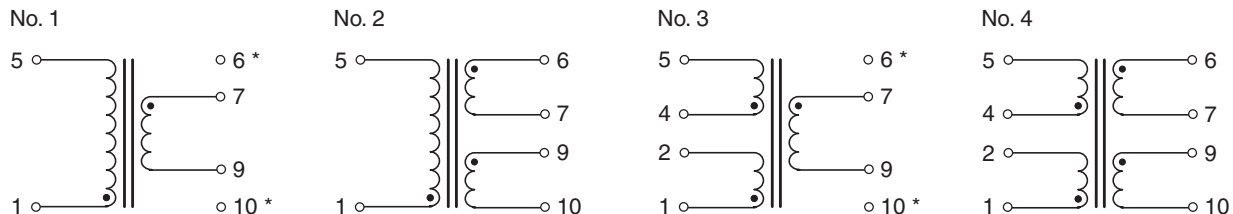

* Empty-Pin

| Primary (V) | Secondary (V / mA) | No-Load Voltage (V) | Schematic No. | Part Number | Agency Approvals |
|-------------|--------------------|---------------------|---------------|-------------|------------------|
| 230 | 6 / 534 | 9.20 | 1 | 038-5187.0 | 1/3* |
| 230 | 9 / 356 | 13.95 | 1 | 038-5190.0 | 1/3* |
| 230 | 12 / 267 | 17.80 | 1 | 038-5193.0 | 1/3* |
| 230 | 15 / 214 | 22.20 | 1 | 038-5196.0 | 1/3* |
| 230 | 18 / 178 | 27.00 | 1 | 038-5199.0 | 1/3* |
| 230 | 24 / 134 | 35.00 | 1 | 038-5205.0 | 1/3* |
| 230 | 2x6 / 267 | 2x8.90 | 2 | 038-5210.0 | 1/3* |
| 230 | 2x9 / 178 | 2x13.40 | 2 | 038-5213.0 | 1/3* |
| 230 | 2x12 / 134 | 2x17.50 | 2 | 038-5216.0 | 1/3* |
| 230 | 2x15 / 107 | 2x22.30 | 2 | 038-5219.0 | 1/3* |
| 230 | 2x18 / 89 | 2x25.80 | 2 | 038-5222.0 | 1 |
| 230 | 2x24 / 67 | 2x35.90 | 2 | 038-5228.0 | 1 |
| 115 | 6 / 534 | 9.20 | 1 | 038-5049.0 | 1/3* |
| 115 | 9 / 356 | 13.95 | 1 | 038-5052.0 | 1/3* |
| 115 | 12 / 267 | 17.80 | 1 | 038-5055.0 | 1/3* |
| 115 | 15 / 214 | 22.20 | 1 | 038-5058.0 | 1/3* |
| 115 | 18 / 178 | 27.00 | 1 | 038-5061.0 | 1/3* |
| 115 | 24 / 134 | 35.00 | 1 | 038-5067.0 | 1/3* |
| 115 | 2x6 / 267 | 2x8.90 | 2 | 038-5072.0 | 1/3* |
| 115 | 2x9 / 178 | 2x13.40 | 2 | 038-5075.0 | 1/3* |
| 115 | 2x12 / 134 | 2x17.50 | 2 | 038-5078.0 | 1/3* |
| 115 | 2x15 / 107 | 2x22.30 | 2 | 038-5081.0 | 1/3* |
| 115 | 2x18 / 89 | 2x25.80 | 2 | 038-5084.0 | 1 |
| 115 | 2x24 / 67 | 2x35.90 | 2 | 038-5090.0 | 1 |
| 2x115 | 6 / 534 | 9.20 | 3 | 038-5325.0 | 1/3* |
| 2x115 | 9 / 356 | 13.95 | 3 | 038-5328.0 | 1/3* |
| 2x115 | 12 / 267 | 17.80 | 3 | 038-5331.0 | 1/3* |
| 2x115 | 15 / 214 | 22.20 | 3 | 038-5334.0 | 1/3* |
| 2x115 | 18 / 178 | 27.00 | 3 | 038-5337.0 | 1/3* |
| 2x115 | 24 / 134 | 35.00 | 3 | 038-5343.0 | 1/3* |
| 2x115 | 2x6 / 267 | 2x8.90 | 4 | 038-5348.0 | 1/3* |
| 2x115 | 2x9 / 178 | 2x13.40 | 4 | 038-5351.0 | 1/3* |
| 2x115 | 2x12 / 134 | 2x17.50 | 4 | 038-5354.0 | 1/3* |
| 2x115 | 2x15 / 107 | 2x22.30 | 4 | 038-5357.0 | 1/3* |
| 2x115 | 2x18 / 89 | 2x25.80 | 4 | 038-5360.0 | 1 |
| 2x115 | 2x24 / 67 | 2x35.90 | 4 | 038-5366.0 | 1 |

*NOTE: When checking the approval status of this product with VDE, add the prefix "BV" and the suffix "F" to the orderable Part Number (these letters will also be found on the part label). The prefix and suffix are not part of the orderable Part Number.

LAMINATED TRANSFORMERS







Type EI38 / 13.6 - 4.0VA



AGENCY APPROVALS   

1. UL 506, File E113449 

3. EN61558 

-  Frequency 50/60Hz
-  Potted under vacuum
-  Split-bobbin
-  Temperature class ta 70°C/B
-  Weight: 0.155kg
-  Packaging unit: 25 pieces (tray)

Mechanical

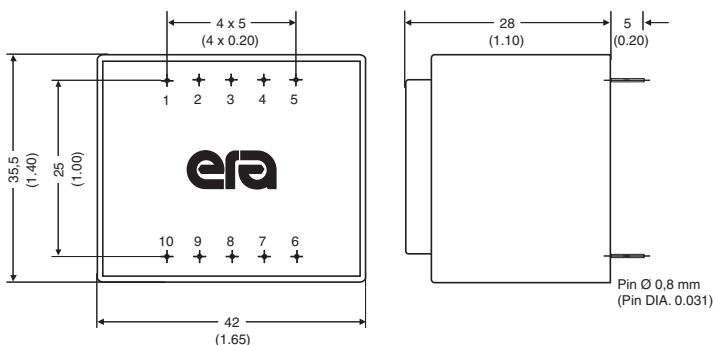

Schematics

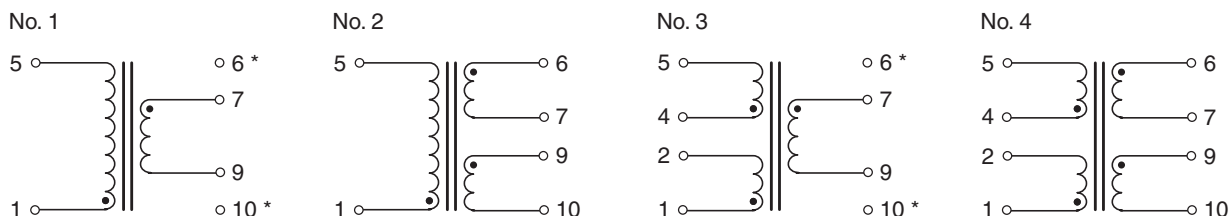

* Empty-Pin

| Primary (V) | Secondary (V / mA) | No-Load Voltage (V) | Schematic No. | Part Number | Agency Approvals |
|-------------|--------------------|---------------------|---------------|-------------|------------------|
| 230 | 6 / 667 | 8.50 | 1 | 038-5412.0 | 1/3* |
| 230 | 9 / 444 | 12.60 | 1 | 038-5413.0 | 1/3* |
| 230 | 12 / 333 | 16.40 | 1 | 038-5414.0 | 1/3* |
| 230 | 15 / 267 | 20.90 | 1 | 038-5415.0 | 1/3* |
| 230 | 18 / 222 | 24.30 | 1 | 038-5416.0 | 1/3* |
| 230 | 24 / 167 | 32.80 | 1 | 038-5417.0 | 1/3* |
| 230 | 2x6 / 333 | 2x8.50 | 2 | 038-5418.0 | 1/3* |
| 230 | 2x9 / 222 | 2x12.50 | 2 | 038-5419.0 | 1/3* |
| 230 | 2x12 / 167 | 2x16.40 | 2 | 038-5420.0 | 1/3* |
| 230 | 2x15 / 133 | 2x21.20 | 2 | 038-5421.0 | 1/3* |
| 230 | 2x18 / 111 | 2x24.50 | 2 | 038-5422.0 | 1/3* |
| 230 | 2x24 / 83 | 2x32.70 | 2 | 038-5423.0 | 1 |
| 115 | 6 / 667 | 8.50 | 1 | 038-5400.0 | 1/3* |
| 115 | 9 / 444 | 12.60 | 1 | 038-5401.0 | 1/3* |
| 115 | 12 / 333 | 16.40 | 1 | 038-5402.0 | 1/3* |
| 115 | 15 / 267 | 20.90 | 1 | 038-5403.0 | 1/3* |
| 115 | 18 / 222 | 24.30 | 1 | 038-5404.0 | 1/3* |
| 115 | 24 / 167 | 32.80 | 1 | 038-5405.0 | 1/3* |
| 115 | 2x6 / 333 | 2x8.50 | 2 | 038-5406.0 | 1/3* |
| 115 | 2x9 / 222 | 2x12.50 | 2 | 038-5407.0 | 1/3* |
| 115 | 2x12 / 167 | 2x16.40 | 2 | 038-5408.0 | 1/3* |
| 115 | 2x15 / 133 | 2x21.20 | 2 | 038-5409.0 | 1/3* |
| 115 | 2x18 / 111 | 2x24.50 | 2 | 038-5410.0 | 1/3* |
| 115 | 2x24 / 83 | 2x32.70 | 2 | 038-5411.0 | 1 |
| 2x115 | 6 / 667 | 8.50 | 3 | 038-5424.0 | 1/3* |
| 2x115 | 9 / 444 | 12.60 | 3 | 038-5425.0 | 1/3* |
| 2x115 | 12 / 333 | 16.40 | 3 | 038-5426.0 | 1/3* |
| 2x115 | 15 / 267 | 20.90 | 3 | 038-5427.0 | 1/3* |
| 2x115 | 18 / 222 | 24.30 | 3 | 038-5428.0 | 1/3* |
| 2x115 | 24 / 167 | 32.80 | 3 | 038-5429.0 | 1/3* |
| 2x115 | 2x6 / 333 | 2x8.50 | 4 | 038-5430.0 | 1/3* |
| 2x115 | 2x9 / 222 | 2x12.50 | 4 | 038-5431.0 | 1/3* |
| 2x115 | 2x12 / 167 | 2x16.40 | 4 | 038-5432.0 | 1/3* |
| 2x115 | 2x15 / 133 | 2x21.20 | 4 | 038-5433.0 | 1/3* |
| 2x115 | 2x18 / 111 | 2x24.50 | 4 | 038-5434.0 | 1/3* |
| 2x115 | 2x24 / 83 | 2x32.70 | 4 | 038-5435.0 | 1 |

*NOTE: When checking the approval status of this product with VDE, add the prefix "BV" and the suffix "F" to the orderable Part Number (these letters will also be found on the part label). The prefix and suffix are not part of the orderable Part Number.

LAMINATED TRANSFORMERS







Type EI42 / 14.8 - 5.0VA



AGENCY APPROVALS 

1. UL 506, File E113449 

3. EN61558 

-  Frequency 50/60Hz
-  Potted under vacuum
-  Split-bobbin
-  Temperature class ta 70°C/B
-  Weight: 0.2kg
-  Packaging unit: 25 pieces (tray)

Mechanical

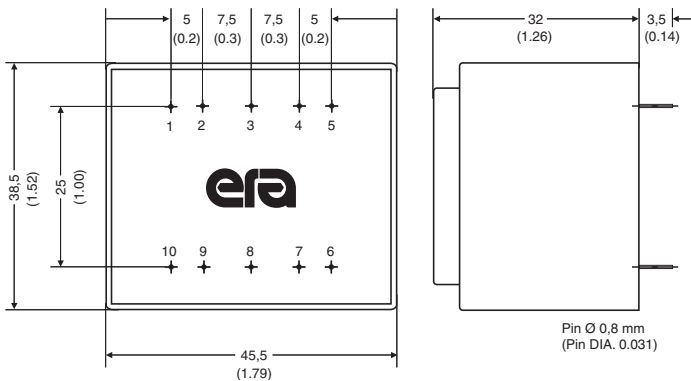

Schematics

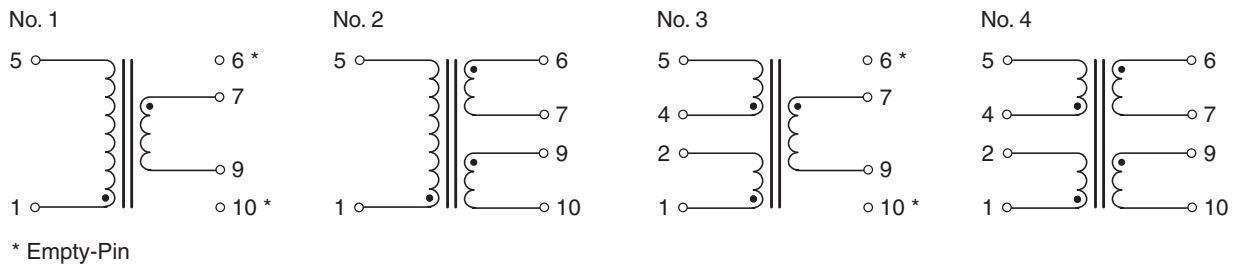

| Primary (V) | Secondary (V / mA) | No-Load Voltage (V) | Schematic No. | Part Number | Agency Approvals |
|-------------|--------------------|---------------------|---------------|-------------|------------------|
| 230 | 6 / 834 | 8.10 | 1 | 042-5187.0 | 1/3* |
| 230 | 9 / 556 | 12.00 | 1 | 042-5190.0 | 1/3* |
| 230 | 12 / 417 | 15.50 | 1 | 042-5193.0 | 1/3* |
| 230 | 15 / 334 | 19.20 | 1 | 042-5196.0 | 1/3* |
| 230 | 18 / 278 | 23.00 | 1 | 042-5199.0 | 1/3* |
| 230 | 24 / 208 | 30.50 | 1 | 042-5205.0 | 1/3* |
| 230 | 2x6 / 417 | 2x7.70 | 2 | 042-5210.0 | 1/3* |
| 230 | 2x9 / 278 | 2x11.60 | 2 | 042-5213.0 | 1/3* |
| 230 | 2x12 / 208 | 2x15.20 | 2 | 042-5216.0 | 1/3* |
| 230 | 2x15 / 167 | 2x19.40 | 2 | 042-5219.0 | 1/3* |
| 230 | 2x18 / 139 | 2x23.10 | 2 | 042-5222.0 | 1/3* |
| 230 | 2x24 / 104 | 2x30.80 | 2 | 042-5228.0 | 1 |
| 115 | 6 / 834 | 8.10 | 1 | 042-5049.0 | 1/3* |
| 115 | 9 / 556 | 12.00 | 1 | 042-5052.0 | 1/3* |
| 115 | 12 / 417 | 15.50 | 1 | 042-5055.0 | 1/3* |
| 115 | 15 / 334 | 19.20 | 1 | 042-5058.0 | 1/3* |
| 115 | 18 / 278 | 23.00 | 1 | 042-5061.0 | 1/3* |
| 115 | 24 / 208 | 30.50 | 1 | 042-5067.0 | 1/3* |
| 115 | 2x6 / 417 | 2x7.70 | 2 | 042-5072.0 | 1/3* |
| 115 | 2x9 / 278 | 2x11.60 | 2 | 042-5075.0 | 1/3* |
| 115 | 2x12 / 208 | 2x15.20 | 2 | 042-5078.0 | 1/3* |
| 115 | 2x15 / 167 | 2x19.40 | 2 | 042-5081.0 | 1/3* |
| 115 | 2x18 / 139 | 2x23.10 | 2 | 042-5084.0 | 1/3* |
| 115 | 2x24 / 104 | 2x30.80 | 2 | 042-5090.0 | 1 |
| 2x115 | 6 / 834 | 8.10 | 3 | 042-5325.0 | 1/3* |
| 2x115 | 9 / 556 | 12.00 | 3 | 042-5328.0 | 1/3* |
| 2x115 | 12 / 417 | 15.50 | 3 | 042-5331.0 | 1/3* |
| 2x115 | 15 / 334 | 19.20 | 3 | 042-5334.0 | 1/3* |
| 2x115 | 18 / 278 | 23.00 | 3 | 042-5337.0 | 1/3* |
| 2x115 | 24 / 208 | 30.50 | 3 | 042-5343.0 | 1/3* |
| 2x115 | 2x6 / 417 | 2x7.70 | 4 | 042-5348.0 | 1/3* |
| 2x115 | 2x9 / 278 | 2x11.60 | 4 | 042-5351.0 | 1/3* |
| 2x115 | 2x12 / 208 | 2x15.20 | 4 | 042-5354.0 | 1/3* |
| 2x115 | 2x15 / 167 | 2x19.40 | 4 | 042-5357.0 | 1/3* |
| 2x115 | 2x18 / 139 | 2x23.10 | 4 | 042-5360.0 | 1/3* |
| 2x115 | 2x24 / 104 | 2x30.80 | 4 | 042-5366.0 | 1 |

*NOTE: When checking the approval status of this product with VDE, add the prefix "BV" and the suffix "G" to the orderable Part Number (these letters will also be found on the part label). The prefix and suffix are not part of the orderable Part Number.

LAMINATED TRANSFORMERS

Type EI48 / 16.8 - 10VA



AGENCY APPROVALS CE

1. UL 506, File E113449 **UL** US

3. EN61558 **IEC** 10 **VDE**

- Frequency 50/60Hz
- Potted under vacuum
- Split-bobbin
- Temperature class ta 40°C/B
- Weight: 0.295kg
- Packaging unit: 15 pieces (tray)

Mechanical

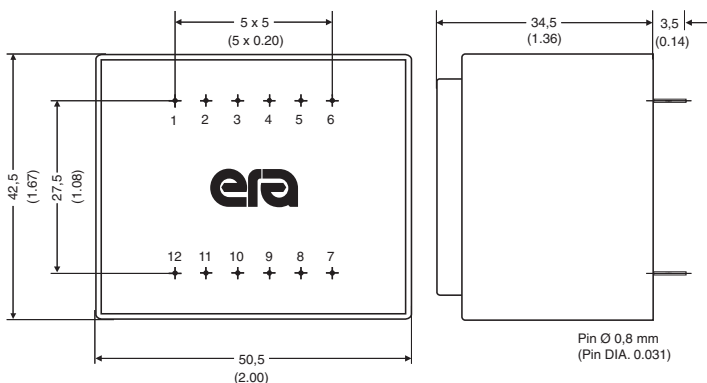

Schematics

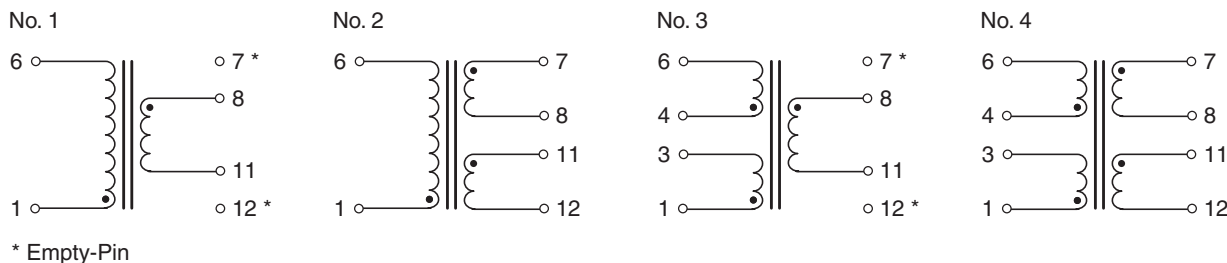

| Primary (V) | Secondary (V / mA) | No-Load Voltage (V) | Schematic No. | Part Number | Agency Approvals |
|-------------|--------------------|---------------------|---------------|-------------|------------------|
| 230 | 6 / 1666 | 7.90 | 1 | 048-5187.0 | 1/3* |
| 230 | 9 / 1111 | 12.00 | 1 | 048-5190.0 | 1/3* |
| 230 | 12 / 834 | 15.70 | 1 | 048-5193.0 | 1/3* |
| 230 | 15 / 666 | 19.20 | 1 | 048-5196.0 | 1/3* |
| 230 | 18 / 555 | 22.90 | 1 | 048-5199.0 | 1/3* |
| 230 | 24 / 416 | 30.60 | 1 | 048-5205.0 | 1/3* |
| 230 | 2x6 / 834 | 2x8.10 | 2 | 048-5210.0 | 1/3* |
| 230 | 2x9 / 555 | 2x11.60 | 2 | 048-5213.0 | 1/3* |
| 230 | 2x12 / 416 | 2x15.70 | 2 | 048-5216.0 | 1/3* |
| 230 | 2x15 / 333 | 2x19.50 | 2 | 048-5219.0 | 1/3* |
| 230 | 2x18 / 277 | 2x23.50 | 2 | 048-5222.0 | 1/3* |
| 230 | 2x24 / 208 | 2x30.00 | 2 | 048-5228.0 | 1 |
| 115 | 6 / 1666 | 7.90 | 1 | 048-5049.0 | 1/3* |
| 115 | 9 / 1111 | 12.00 | 1 | 048-5052.0 | 1/3* |
| 115 | 12 / 834 | 15.70 | 1 | 048-5055.0 | 1/3* |
| 115 | 15 / 666 | 19.20 | 1 | 048-5058.0 | 1/3* |
| 115 | 18 / 555 | 22.90 | 1 | 048-5061.0 | 1/3* |
| 115 | 24 / 416 | 30.60 | 1 | 048-5067.0 | 1/3* |
| 115 | 2x6 / 834 | 2x8.10 | 2 | 048-5072.0 | 1/3* |
| 115 | 2x9 / 555 | 2x11.60 | 2 | 048-5075.0 | 1/3* |
| 115 | 2x12 / 416 | 2x15.70 | 2 | 048-5078.0 | 1/3* |
| 115 | 2x15 / 333 | 2x19.50 | 2 | 048-5081.0 | 1/3* |
| 115 | 2x18 / 277 | 2x23.50 | 2 | 048-5084.0 | 1/3* |
| 115 | 2x24 / 208 | 2x30.00 | 2 | 048-5090.0 | 1 |
| 2x115 | 6 / 1666 | 7.90 | 3 | 048-5325.0 | 1/3* |
| 2x115 | 9 / 1111 | 12.00 | 3 | 048-5328.0 | 1/3* |
| 2x115 | 12 / 834 | 15.70 | 3 | 048-5331.0 | 1/3* |
| 2x115 | 15 / 666 | 19.20 | 3 | 048-5334.0 | 1/3* |
| 2x115 | 18 / 555 | 22.90 | 3 | 048-5337.0 | 1/3* |
| 2x115 | 24 / 416 | 30.60 | 3 | 048-5343.0 | 1/3* |
| 2x115 | 2x6 / 834 | 2x8.10 | 4 | 048-5348.0 | 1/3* |
| 2x115 | 2x9 / 555 | 2x11.60 | 4 | 048-5351.0 | 1/3* |
| 2x115 | 2x12 / 416 | 2x15.70 | 4 | 048-5354.0 | 1/3* |
| 2x115 | 2x15 / 333 | 2x19.50 | 4 | 048-5357.0 | 1/3* |
| 2x115 | 2x18 / 277 | 2x23.50 | 4 | 048-5360.0 | 1/3* |
| 2x115 | 2x24 / 208 | 2x30.00 | 4 | 048-5366.0 | 1 |

*NOTE: When checking the approval status of this product with VDE, add the prefix "BV" and the suffix "H" to the orderable Part Number (these letters will also be found on the part label). The prefix and suffix are **not** part of the orderable Part Number.

LAMINATED TRANSFORMERS







Type EI54 / 18.8 - 16VA



AGENCY APPROVALS   

1. UL 506, File E113449 

3. EN61558 

-  Frequency 50/60Hz
-  Potted under vacuum
-  Split-bobbin
-  Temperature class ta 40°C/B
-  Weight: 0.42kg
-  Packaging unit: 10 pieces (tray)

Mechanical

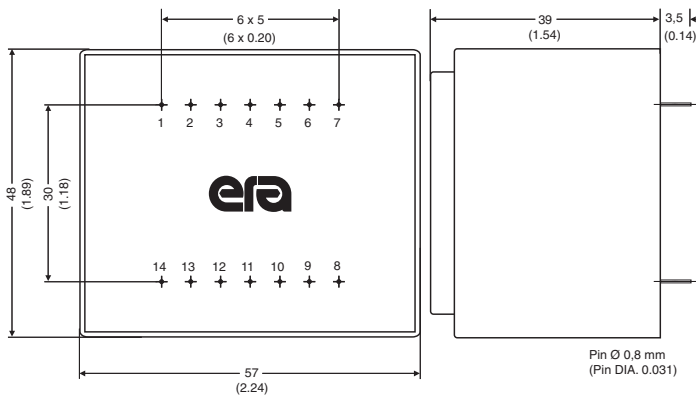

Schematics

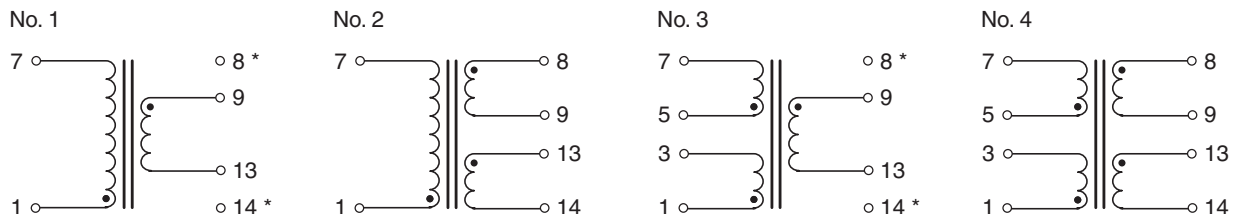

* Empty-Pin

| Primary (V) | Secondary (V / mA) | No-Load Voltage (V) | Schematic No. | Part Number | Agency Approvals |
|-------------|--------------------|---------------------|---------------|-------------|------------------|
| 230 | 6 / 2666 | 7.60 | 1 | 054-5187.0 | 1/3* |
| 230 | 9 / 1777 | 11.30 | 1 | 054-5190.0 | 1/3* |
| 230 | 12 / 1333 | 14.90 | 1 | 054-5193.0 | 1/3* |
| 230 | 15 / 1066 | 18.40 | 1 | 054-5196.0 | 1/3* |
| 230 | 18 / 888 | 22.40 | 1 | 054-5199.0 | 1/3* |
| 230 | 24 / 666 | 29.60 | 1 | 054-5205.0 | 1/3* |
| 230 | 2x6 / 1333 | 2x7.70 | 2 | 054-5210.0 | 1/3* |
| 230 | 2x9 / 888 | 2x11.40 | 2 | 054-5213.0 | 1/3* |
| 230 | 2x12 / 666 | 2x15.00 | 2 | 054-5216.0 | 1/3* |
| 230 | 2x15 / 533 | 2x18.70 | 2 | 054-5219.0 | 1/3* |
| 230 | 2x18 / 444 | 2x22.40 | 2 | 054-5222.0 | 1/3* |
| 230 | 2x24 / 333 | 2x29.00 | 2 | 054-5228.0 | 1 |
| 115 | 6 / 2666 | 7.60 | 1 | 054-5049.0 | 1/3* |
| 115 | 9 / 1777 | 11.30 | 1 | 054-5052.0 | 1/3* |
| 115 | 12 / 1333 | 14.90 | 1 | 054-5055.0 | 1/3* |
| 115 | 15 / 1066 | 18.40 | 1 | 054-5058.0 | 1/3* |
| 115 | 18 / 888 | 22.40 | 1 | 054-5061.0 | 1/3* |
| 115 | 24 / 666 | 29.60 | 1 | 054-5067.0 | 1/3* |
| 115 | 2x6 / 1333 | 2x7.70 | 2 | 054-5072.0 | 1/3* |
| 115 | 2x9 / 888 | 2x11.40 | 2 | 054-5075.0 | 1/3* |
| 115 | 2x12 / 666 | 2x15.00 | 2 | 054-5078.0 | 1/3* |
| 115 | 2x15 / 533 | 2x18.70 | 2 | 054-5081.0 | 1/3* |
| 115 | 2x18 / 444 | 2x22.40 | 2 | 054-5084.0 | 1/3* |
| 115 | 2x24 / 333 | 2x29.00 | 2 | 054-5090.0 | 1 |
| 2x115 | 6 / 2666 | 7.60 | 3 | 054-5325.0 | 1/3* |
| 2x115 | 9 / 1777 | 11.30 | 3 | 054-5328.0 | 1/3* |
| 2x115 | 12 / 1333 | 14.90 | 3 | 054-5331.0 | 1/3* |
| 2x115 | 15 / 1066 | 18.40 | 3 | 054-5334.0 | 1/3* |
| 2x115 | 18 / 888 | 22.40 | 3 | 054-5337.0 | 1/3* |
| 2x115 | 24 / 666 | 29.60 | 3 | 054-5343.0 | 1/3* |
| 2x115 | 2x6 / 1333 | 2x7.70 | 4 | 054-5348.0 | 1/3* |
| 2x115 | 2x9 / 888 | 2x11.40 | 4 | 054-5351.0 | 1/3* |
| 2x115 | 2x12 / 666 | 2x15.00 | 4 | 054-5354.0 | 1/3* |
| 2x115 | 2x15 / 533 | 2x18.70 | 4 | 054-5357.0 | 1/3* |
| 2x115 | 2x18 / 444 | 2x22.40 | 4 | 054-5360.0 | 1/3* |
| 2x115 | 2x24 / 333 | 2x29.00 | 4 | 054-5366.0 | 1 |

*NOTE: When checking the approval status of this product with VDE, add the prefix "BV" and the suffix "K" to the orderable Part Number (these letters will also be found on the part label). The prefix and suffix are not part of the orderable Part Number.

LAMINATED TRANSFORMERS

Type EI42 / 14.8 - 5VA









AGENCY APPROVALS 

1. UL 506, File E113449  

3. EN61558  

| Primary (V) | Secondary (V / mA) | No-Load Voltage (V) | Schematic No. | Part Number | Agency Approvals |
|-------------|--------------------|---------------------|---------------|-------------------|------------------|
| 230 | 6 / 834 | 8.10 | 1 | 042-5381.0 | 1/3* |
| 230 | 9 / 556 | 12.00 | 1 | 042-5382.0 | 1/3* |
| 230 | 12 / 417 | 15.50 | 1 | 042-5383.0 | 1/3* |
| 230 | 15 / 334 | 19.20 | 1 | 042-5384.0 | 1/3* |
| 230 | 18 / 278 | 23.20 | 1 | 042-5385.0 | 1/3* |
| 230 | 24 / 208 | 30.50 | 1 | 042-5386.0 | 1/3* |
| 230 | 2x6 / 417 | 2x7.80 | 2 | 042-5387.0 | 1/3* |
| 230 | 2x9 / 278 | 2x11.60 | 2 | 042-5388.0 | 1/3* |
| 230 | 2x12 / 208 | 2x15.20 | 2 | 042-5389.0 | 1/3* |
| 230 | 2x15 / 167 | 2x19.40 | 2 | 042-5390.0 | 1/3* |

*NOTE: When checking the approval status of this product with VDE, add the prefix "BV" and the suffix "G" to the orderable Part Number (these letters will also be found on the part label). The prefix and suffix are not part of the orderable Part Number.

-  Frequency 50/60Hz
-  Potted under vacuum
-  Split-bobbin
-  Temperature class ta 70°C/B
-  Weight: 0.2kg
-  Packaging unit: 15 pieces (tray)

Mechanical

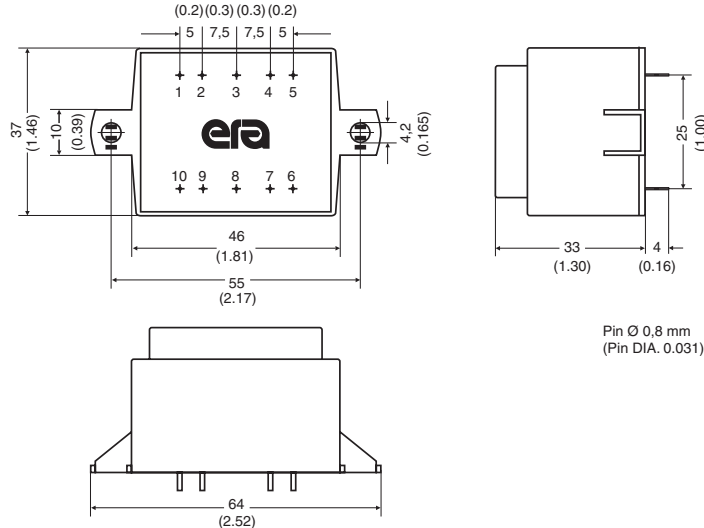

Schematics

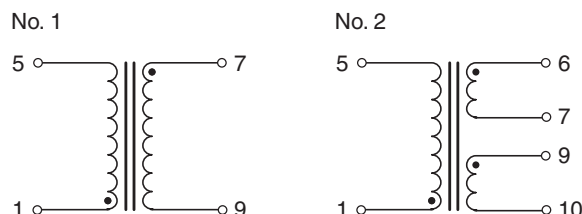

LAMINATED TRANSFORMERS

Type EI48 / 16.8 - 10VA



| Primary (V) | Secondary (V / mA) | No-Load Voltage (V) | Schematic No. | Part Number | Agency Approvals |
|-------------|--------------------|---------------------|---------------|-------------|------------------|
| 230 | 6 / 1666 | 7.90 | 1 | 048-5381.0 | 1/3* |
| 230 | 9 / 1111 | 12.00 | 1 | 048-5382.0 | 1/3* |
| 230 | 12 / 834 | 15.70 | 1 | 048-5383.0 | 1/3* |
| 230 | 15 / 666 | 19.20 | 1 | 048-5384.0 | 1/3* |
| 230 | 18 / 555 | 22.90 | 1 | 048-5385.0 | 1/3* |
| 230 | 24 / 416 | 30.60 | 1 | 048-5386.0 | 1/3* |
| 230 | 2x6 / 834 | 2x7.90 | 2 | 048-5387.0 | 1/3* |
| 230 | 2x9 / 555 | 2x12.00 | 2 | 048-5388.0 | 1/3* |
| 230 | 2x12 / 416 | 2x15.70 | 2 | 048-5389.0 | 1/3* |
| 230 | 2x15 / 333 | 2x19.20 | 2 | 048-5390.0 | 1/3* |

*NOTE: When checking the approval status of this product with VDE, add the prefix "BV" and the suffix "H" to the orderable Part Number (these letters will also be found on the part label). The prefix and suffix are not part of the orderable Part Number.

- ⦿ Frequency 50/60Hz
- ⦿ Potted under vacuum
- ⦿ Split-bobbin
- ⦿ Temperature class ta 40°C/B
- ⦿ Weight: 0.295kg
- ⦿ Packaging unit: 10 pieces (tray)

Mechanical

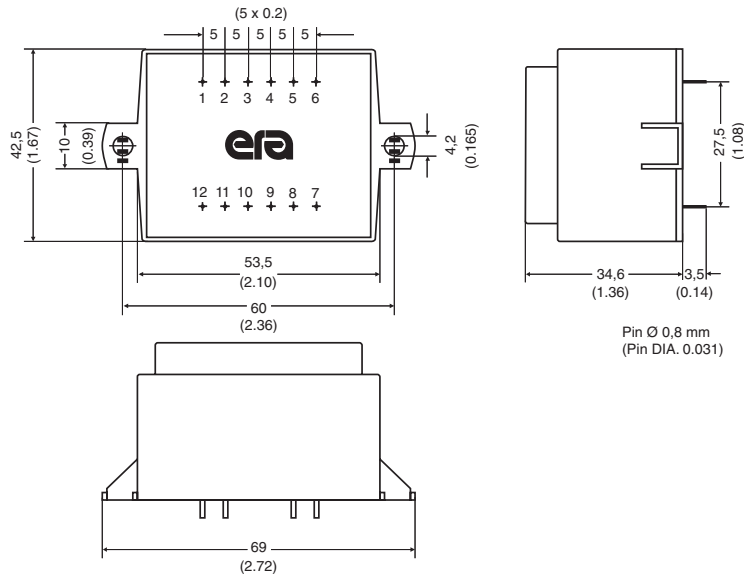

Schematics

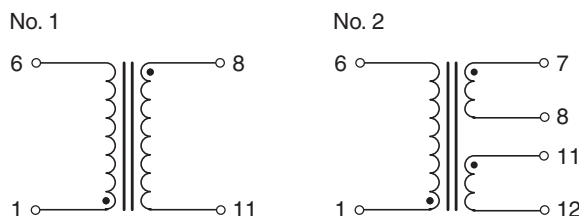

LAMINATED TRANSFORMERS

Type EI60 / 25.5 - 25VA



- Frequency 50/60Hz
- Potted under vacuum
- Split-bobbin
- Temperature class ta 40°C/B
- Weight: 0.67kg
- Packaging unit: 6 pieces (tray)

| Primary (V) | Secondary (V / mA) | No-Load Voltage (V) | Schematic No. | Part Number | Agency Approvals |
|-------------|--------------------|---------------------|---------------|-------------|------------------|
| 230 | 6 / 4170 | 6.90 | 1 | 060-0201.0 | 3* |
| 230 | 9 / 2780 | 10.30 | 1 | 060-0202.0 | 3* |
| 230 | 12 / 2080 | 13.60 | 1 | 060-0203.0 | 3* |
| 230 | 15 / 1670 | 17.00 | 1 | 060-0204.0 | 3* |
| 230 | 18 / 1390 | 20.50 | 1 | 060-0205.0 | 3* |
| 230 | 24 / 1040 | 27.00 | 1 | 060-0206.0 | 3* |
| 230 | 2x6 / 2080 | 2x6.90 | 2 | 060-0207.0 | 3* |
| 230 | 2x9 / 1390 | 2x10.50 | 2 | 060-0208.0 | 3* |
| 230 | 2x12 / 1040 | 2x13.60 | 2 | 060-0209.0 | 3* |
| 230 | 2x15 / 830 | 2x17.30 | 2 | 060-0210.0 | 3* |
| 2x115 | 6 / 4170 | 6.90 | 3 | 060-0272.0 | 3* |
| 2x115 | 9 / 2780 | 10.30 | 3 | 060-0273.0 | 3* |
| 2x115 | 12 / 2080 | 13.60 | 3 | 060-0274.0 | 3* |
| 2x115 | 15 / 1670 | 17.00 | 3 | 060-0275.0 | 3* |
| 2x115 | 18 / 1390 | 20.50 | 3 | 060-0276.0 | 3* |
| 2x115 | 24 / 1040 | 27.00 | 3 | 060-0277.0 | 3* |
| 2x115 | 2x6 / 2080 | 2x6.90 | 4 | 060-0278.0 | 3* |
| 2x115 | 2x9 / 1390 | 2x10.50 | 4 | 060-0279.0 | 3* |
| 2x115 | 2x12 / 1040 | 2x13.60 | 4 | 060-0280.0 | 3* |
| 2x115 | 2x15 / 830 | 2x17.30 | 4 | 060-0281.0 | 3* |

Mechanical

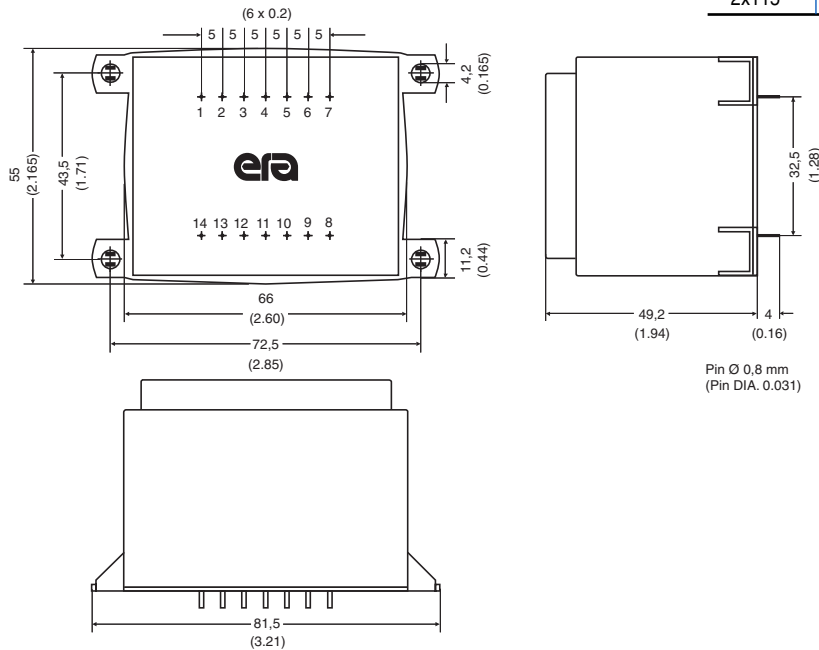

***NOTE:** When checking the approval status of this product with VDE, add the prefix "BV" to the orderable Part Number (these letters will also be found on the part label). The prefix is **not** part of the orderable Part Number.

Schematics

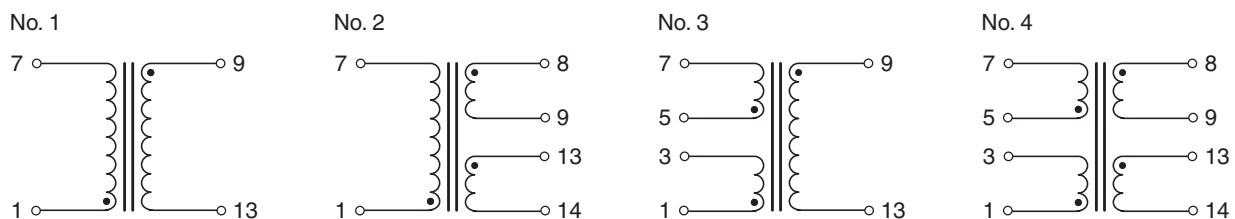

LAMINATED TRANSFORMERS

Type EI66 / 23 - 36VA



- Frequency 50/60Hz
- Potted under vacuum
- Split-bobbin
- Temperature class ta 40°C/B
- Weight: 0.75kg
- Packaging unit: 6 pieces (tray)

| Primary (V) | Secondary (V / mA) | No-Load Voltage (V) | Schematic No. | Part Number | Agency Approvals |
|-------------|--------------------|---------------------|---------------|-------------|------------------|
| 230 | 6 / 6000 | 6.90 | 1 | 066-0131.0 | 3* |
| 230 | 9 / 4000 | 10.30 | 1 | 066-0132.0 | 3* |
| 230 | 12 / 3000 | 13.60 | 1 | 066-0133.0 | 3* |
| 230 | 15 / 2400 | 17.00 | 1 | 066-0134.0 | 3* |
| 230 | 18 / 2000 | 20.50 | 1 | 066-0135.0 | 3* |
| 230 | 24 / 1500 | 27.00 | 1 | 066-0136.0 | 3* |
| 230 | 2x6 / 3000 | 2x6.90 | 2 | 066-0137.0 | 3* |
| 230 | 2x9 / 2000 | 2x10.50 | 2 | 066-0138.0 | 3* |
| 230 | 2x12 / 1500 | 2x13.60 | 2 | 066-0139.0 | 3* |
| 230 | 2x15 / 1200 | 2x17.30 | 2 | 066-0140.0 | 3* |
| 2x115 | 6 / 6000 | 6.90 | 3 | 066-0226.0 | 3* |
| 2x115 | 9 / 4000 | 10.30 | 3 | 066-0227.0 | 3* |
| 2x115 | 12 / 3000 | 13.60 | 3 | 066-0228.0 | 3* |
| 2x115 | 15 / 2400 | 17.00 | 3 | 066-0229.0 | 3* |
| 2x115 | 18 / 2000 | 20.50 | 3 | 066-0230.0 | 3* |
| 2x115 | 24 / 1500 | 27.00 | 3 | 066-0231.0 | 3* |
| 2x115 | 2x6 / 3000 | 2x6.90 | 4 | 066-0232.0 | 3* |
| 2x115 | 2x9 / 2000 | 2x10.50 | 4 | 066-0233.0 | 3* |
| 2x115 | 2x12 / 1500 | 2x13.60 | 4 | 066-0234.0 | 3* |
| 2x115 | 2x15 / 1200 | 2x17.30 | 4 | 066-0235.0 | 3* |

Mechanical

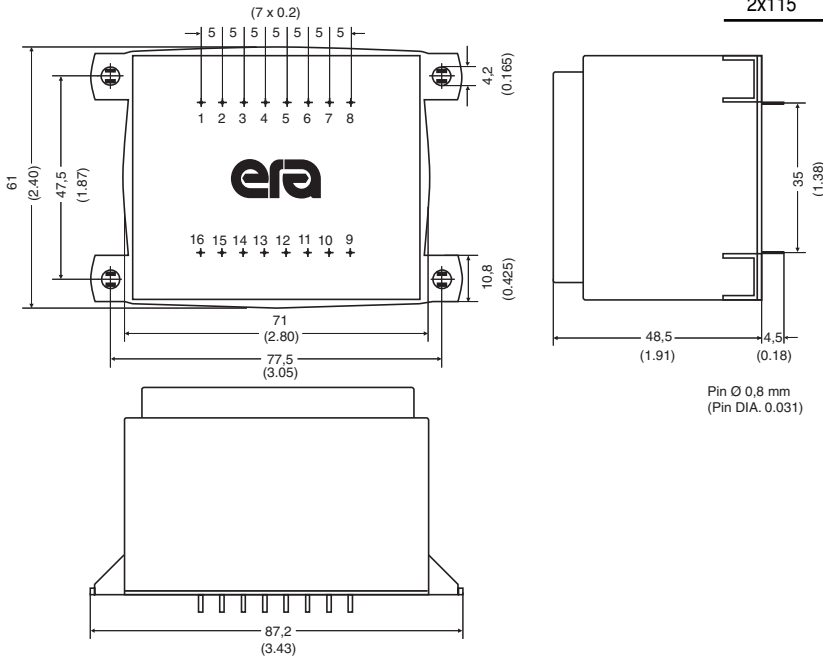

***NOTE:** When checking the approval status of this product with VDE, add the prefix "BV" and the suffix "A" to the orderable Part Number (these letters will also be found on the part label). The prefix and suffix are **not** part of the orderable Part Number.

Schematics

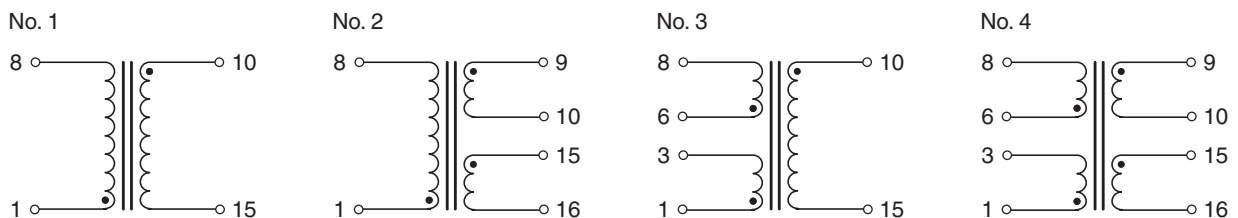

LAMINATED TRANSFORMERS

Type EI66 / 34.7 - 50VA (230V)



| Primary (V) | Secondary (V / mA) | No-Load Voltage (V) | Schematic No. | Part Number | Agency Approvals |
|-------------|--------------------|---------------------|---------------|-------------|------------------|
| 230 | 6 / 8333 | 7.20 | 1 | 066-0141.0 | 3* |
| 230 | 9 / 5560 | 10.40 | 1 | 066-0142.0 | 3* |
| 230 | 12 / 4170 | 13.40 | 1 | 066-0143.0 | 3* |
| 230 | 15 / 3330 | 17.00 | 1 | 066-0144.0 | 3* |
| 230 | 18 / 2780 | 20.50 | 1 | 066-0145.0 | 3* |
| 230 | 24 / 2080 | 27.10 | 1 | 066-0146.0 | 3* |
| 230 | 2x6 / 4170 | 2x7.00 | 2 | 066-0147.0 | 3* |
| 230 | 2x9 / 2780 | 2x10.40 | 2 | 066-0148.0 | 3* |
| 230 | 2x12 / 2080 | 2x13.60 | 2 | 066-0149.0 | 3* |
| 230 | 2x15 / 1670 | 2x17.60 | 2 | 066-0150.0 | 3* |

*NOTE: When checking the approval status of this product with VDE, add the prefix "BV" and the suffix "B" to the orderable Part Number (these letters will also be found on the part label). The prefix and suffix are not part of the orderable Part Number.

- ⦿ Frequency 50/60Hz
- ⦿ Potted under vacuum
- ⦿ Split-bobbin
- ⦿ Temperature class ta 40°C/B
- ⦿ Weight: 1.04kg
- ⦿ Packaging unit: 6 pieces (tray)

Mechanical

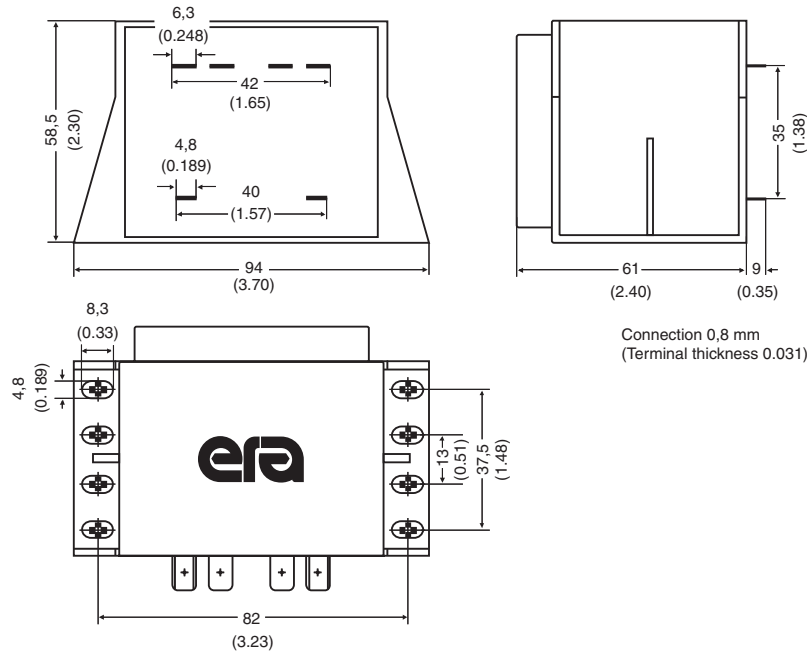

Schematics

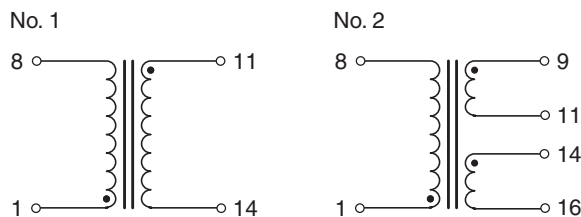

LAMINATED TRANSFORMERS

Type EI66 / 34.7 - 50VA (2x115V)



| Primary (V) | Secondary (V / mA) | No-Load Voltage (V) | Schematic No. | Part Number | Agency Approvals |
|-------------|--------------------|---------------------|---------------|-------------|------------------|
| 2x115 | 6 / 8333 | 7.20 | 1 | 066-0236.0 | 3* |
| 2x115 | 9 / 5560 | 10.40 | 1 | 066-0237.0 | 3* |
| 2x115 | 12 / 4170 | 13.40 | 1 | 066-0238.0 | 3* |
| 2x115 | 15 / 3330 | 17.00 | 1 | 066-0239.0 | 3* |
| 2x115 | 18 / 2780 | 20.50 | 1 | 066-0240.0 | 3* |
| 2x115 | 24 / 2080 | 27.10 | 1 | 066-0241.0 | 3* |
| 2x115 | 2x6 / 4170 | 2x7.00 | 2 | 066-0242.0 | 3* |
| 2x115 | 2x9 / 2780 | 2x10.40 | 2 | 066-0243.0 | 3* |
| 2x115 | 2x12 / 2080 | 2x13.60 | 2 | 066-0244.0 | 3* |
| 2x115 | 2x15 / 1670 | 2x17.60 | 2 | 066-0245.0 | 3* |

*NOTE: When checking the approval status of this product with VDE, add the prefix "BV" and the suffix "B" to the orderable Part Number (these letters will also be found on the part label). The prefix and suffix are not part of the orderable Part Number.

- ⊕ Frequency 50/60Hz
- ⊕ Potted under vacuum
- ⊕ Split-bobbin
- ⊕ Temperature class ta 40°C/B
- ⊕ Weight: 1.04kg
- ⊕ Packaging unit: 6 pieces (tray)

Mechanical

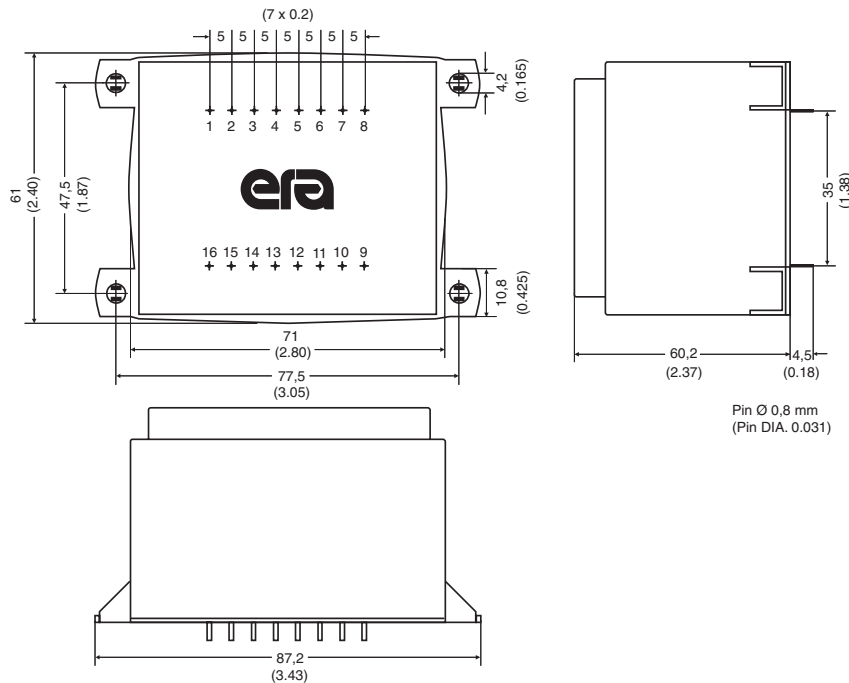

Schematics

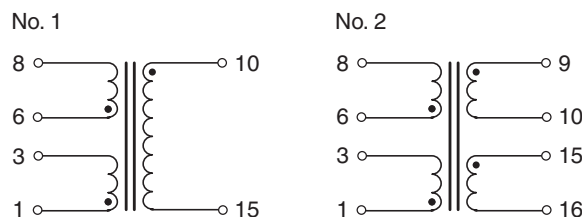

LAMINATED TRANSFORMERS

Type UI30 / 5.5 - 2VA









AGENCY APPROVALS 

1. UL 506, File E113449 

3. EN61558 

| Primary (V) | Secondary (V / mA) | No-Load Voltage (V) | Part Number | Agency Approvals |
|-------------|--------------------|---------------------|-------------------|------------------|
| 2x115 | 6/166 / 6/166 | 9.10/9.10 | 030-6866.0 | 1/3* |
| 2x115 | 9/111 / 9/111 | 13.60/13.60 | 030-6869.0 | 1/3* |
| 2x115 | 12/83 / 12/83 | 17.60/17.60 | 030-6872.0 | 1/3* |
| 2x115 | 15 / 66 / 15/66 | 23.00/23.00 | 030-6875.0 | 1/3* |
| 2x115 | 18/55 / 18/55 | 24.80/24.80 | 030-6878.0 | 1/3* |
| 2x115 | 21/47 / 21/47 | 30.50/30.50 | 030-6881.0 | 1 |

***NOTE:** When checking the approval status of this product with VDE, add the prefix "BV" and the suffix "L" to the orderable Part Number (these letters will also be found on the part label). **The prefix and suffix are not part of the orderable Part Number.**

-  Frequency 50/60Hz
-  Potted under vacuum
-  Split-bobbin
-  Temperature class ta 70°C/B
-  Weight: 0.115kg
-  Packaging unit: 15 pieces (tray)
-  Fixing material for □ 2,5mm (0.098 inch)
 - Self-tapping screws: DIN 7513 (M 3x8)
 - Sheet-metal screws: DIN 7971 (2,9x6,5)

Mechanical

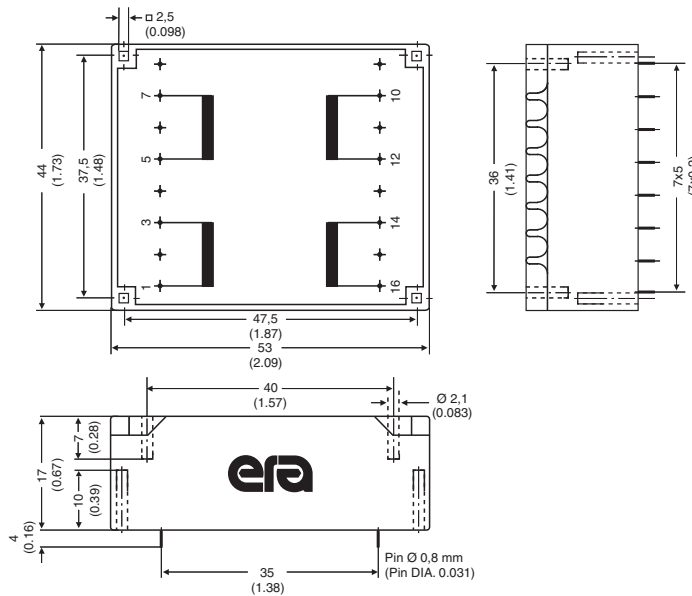

Schematics

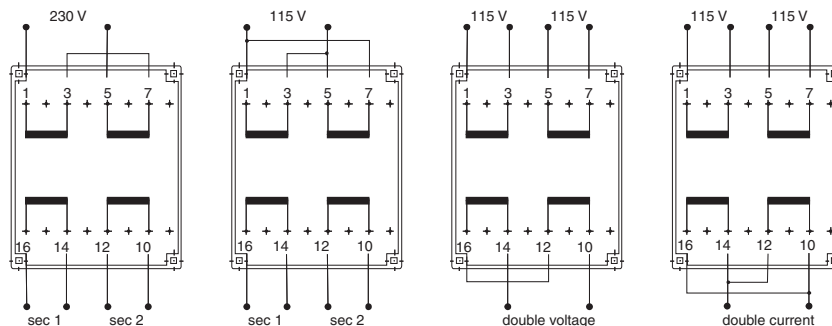

LAMINATED TRANSFORMERS

Type UI30 / 7.5 - 4VA









AGENCY APPROVALS   

1. UL 506, File E113449

3. EN61558

| Primary (V) | Secondary (V / mA) | No-Load Voltage (V) | Part Number | Agency Approvals |
|-------------|--------------------|---------------------|-------------------|------------------|
| 2x115 | 6/333 / 6/333 | 8.60/8.60 | 030-6935.0 | 1/3* |
| 2x115 | 9/222 / 9/222 | 12.40/12.40 | 030-6938.0 | 1/3* |
| 2x115 | 12/166 / 12/166 | 15.90/15.90 | 030-6941.0 | 1/3* |
| 2x115 | 15/133 / 15/133 | 20.80/20.80 | 030-6944.0 | 1/3* |
| 2x115 | 18/111 / 18/111 | 24.30/24.30 | 030-6947.0 | 1/3* |
| 2x115 | 21/95 / 21/95 | 28.10/28.10 | 030-6950.0 | 1 |

***NOTE:** When checking the approval status of this product with VDE, add the prefix "BV" and the suffix "L" to the orderable Part Number (these letters will also be found on the part label). The prefix and suffix are not part of the orderable Part Number.

-  Frequency 50/60Hz
-  Potted under vacuum
-  Split-bobbin
-  Temperature class ta 70°C/B
-  Weight: 0.145kg
-  Packaging unit: 15 pieces (tray)
-  Fixing material for □ 2,5mm (0.098 inch)
 - Self-tapping screws: DIN 7513 (M 3x8)
 - Sheet-metal screws: DIN 7971 (2,9x6,5)

Mechanical

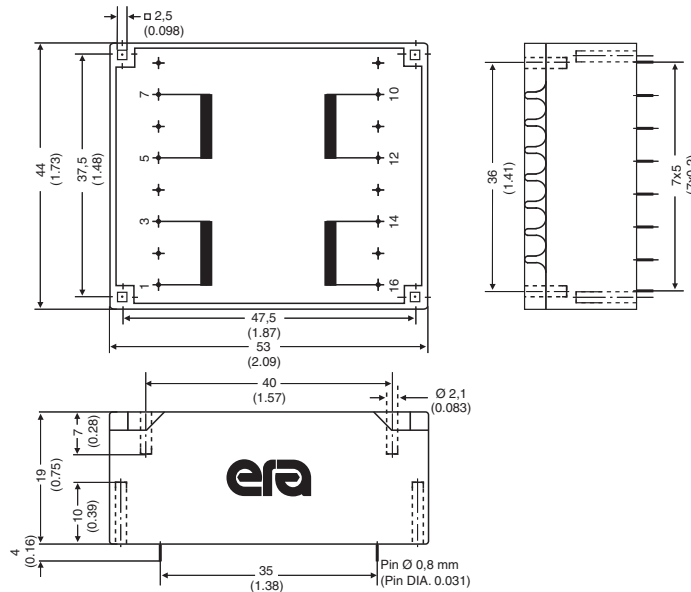

Schematics

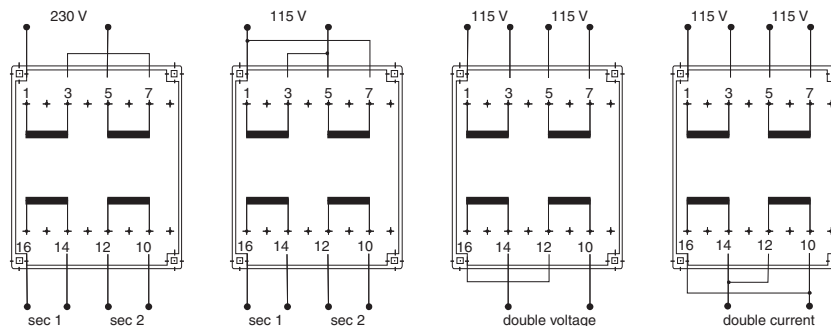

LAMINATED TRANSFORMERS

Type UI30 / 10.5 - 6VA









AGENCY APPROVALS 

1. UL 506, File E113449 

3. EN61558  

| Primary (V) | Secondary (V / mA) | No-Load Voltage (V) | Part Number | Agency Approvals |
|-------------|--------------------|---------------------|-------------------|------------------|
| 2x115 | 6/500 / 6/500 | 8.50/8.50 | 030-7004.0 | 1/3* |
| 2x115 | 9/333 / 9/333 | 12.70/12.70 | 030-7007.0 | 1/3* |
| 2x115 | 12/250 / 12/250 | 16.30/16.30 | 030-7010.0 | 1/3* |
| 2x115 | 15/200 / 15/200 | 20.30/20.30 | 030-7013.0 | 1/3* |
| 2x115 | 18/166 / 18/166 | 24.30/24.30 | 030-7016.0 | 1/3* |
| 2x115 | 21/142 / 21/142 | 28.30/28.30 | 030-7019.0 | 1 |

***NOTE:** When checking the approval status of this product with VDE, add the prefix "BV" and the suffix "L" to the orderable Part Number (these letters will also be found on the part label). The prefix and suffix are not part of the orderable Part Number.

-  Frequency 50/60Hz
-  Potted under vacuum
-  Split-bobbin
-  Temperature class ta 40°C/B
-  Weight: 0.175kg
-  Packaging unit: 15 pieces (tray)
-  Fixing material for \square 2,5mm (0.098 inch)
 - Self-tapping screws: DIN 7513 (M 3x8)
 - Sheet-metal screws: DIN 7971 (2,9x6,5)

Mechanical

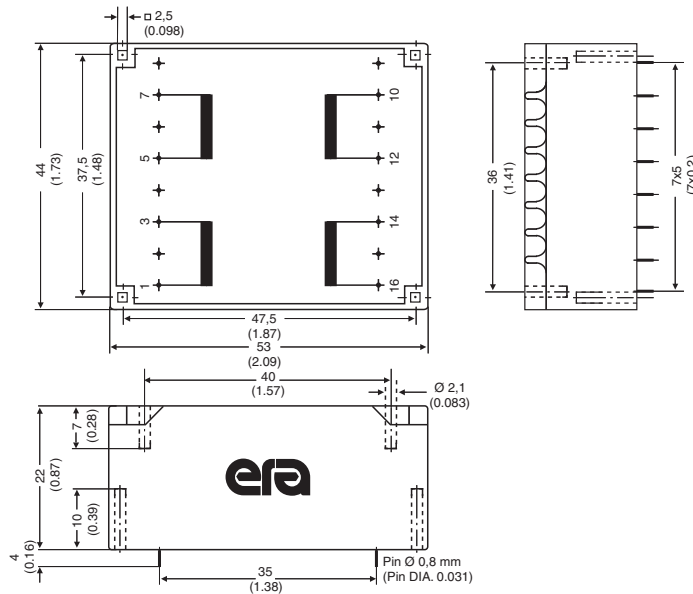

Schematics

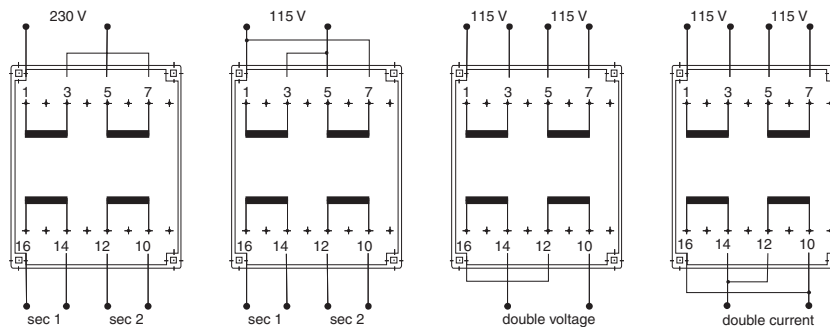

LAMINATED TRANSFORMERS

Type UI30 / 16.5 - 10VA









AGENCY APPROVALS   

1. UL 506, File E113449 

3. EN61558 

| Primary (V) | Secondary (V / mA) | No-Load Voltage (V) | Part Number | Agency Approvals |
|-------------|--------------------|---------------------|-------------------|------------------|
| 2x115 | 6/833 / 6/833 | 9.00/9.00 | 030-7073.0 | 1/3* |
| 2x115 | 9/555 / 9/555 | 13.40/13.40 | 030-7076.0 | 1/3* |
| 2x115 | 12/416 / 12/416 | 17.20/17.20 | 030-7079.0 | 1/3* |
| 2x115 | 15/333 / 15/333 | 21.70/21.70 | 030-7082.0 | 1/3* |
| 2x115 | 18/277 / 18/277 | 24.80/24.80 | 030-7085.0 | 1/3* |
| 2x115 | 21/238 / 21/238 | 29.50/29.50 | 030-7088.0 | 1 |

*NOTE: When checking the approval status of this product with VDE, add the prefix "BV" and the suffix "L" to the orderable Part Number (these letters will also be found on the part label). The prefix and suffix are not part of the orderable Part Number.

-  Frequency 50/60Hz
-  Potted under vacuum
-  Split-bobbin
-  Temperature class ta 40°C/B
-  Weight: 0.24kg
-  Packaging unit: 15 pieces (tray)
-  Fixing material for □ 2,5mm (0.098 inch)
 - Self-tapping screws: DIN 7513 (M 3x8)
 - Sheet-metal screws: DIN 7971 (2,9x6,5)

Mechanical

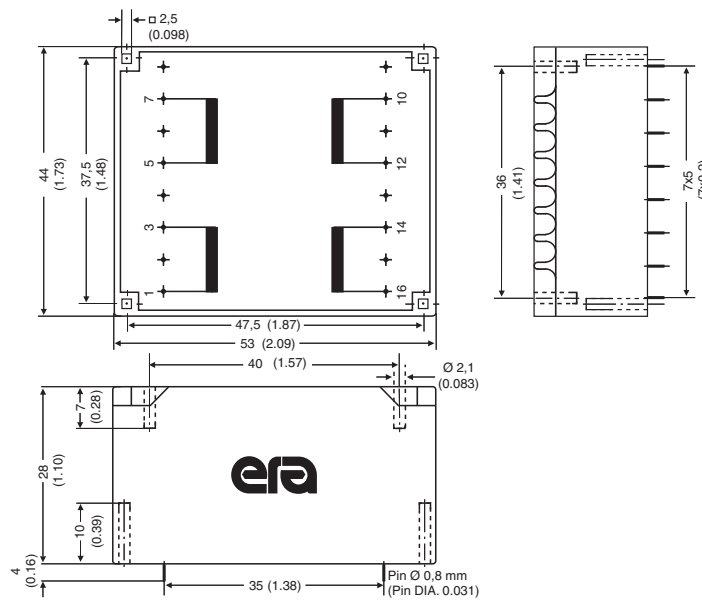

Schematics

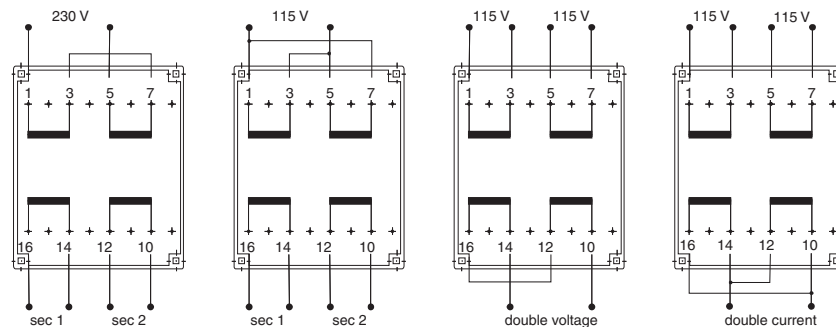



LAMINATED TRANSFORMERS

Type UI39 / 8 - 10VA









AGENCY APPROVALS 

1. UL 506, File E113449 

3. EN61558  

| Primary (V) | Secondary (V / mA) | No-Load Voltage (V) | Part Number | Agency Approvals |
|-------------|--------------------|---------------------|-------------------|------------------|
| 2x115 | 6/833 / 6/833 | 8.50/8.50 | 039-5026.0 | 1/3* |
| 2x115 | 9/555 / 9/555 | 12.40/12.40 | 039-5029.0 | 1/3* |
| 2x115 | 12/416 / 12/416 | 15.90/15.90 | 039-5032.0 | 1/3* |
| 2x115 | 15/333 / 15/333 | 20.30/20.30 | 039-5035.0 | 1/3* |
| 2x115 | 18/277 / 18/277 | 24.30/24.30 | 039-5038.0 | 1/3* |
| 2x115 | 21/238 / 21/238 | 28.10/28.10 | 039-5041.0 | 1 |

***NOTE:** When checking the approval status of this product with VDE, add the prefix "BV" and the suffix "L" to the orderable Part Number (these letters will also be found on the part label). **The prefix and suffix are not part of the orderable Part Number.**

-  Frequency 50/60Hz
-  Potted under vacuum
-  Split-bobbin
-  Temperature class ta 40°C/B
-  Weight: 0.28kg
-  Packaging unit: 10 pieces (tray)
-  Fixing material for \square 2,5mm (0.098 inch)
 - Self-tapping screws: DIN 7513 (M 3x8)
 - Sheet-metal screws: DIN 7971 (2,9x6,5)

Mechanical

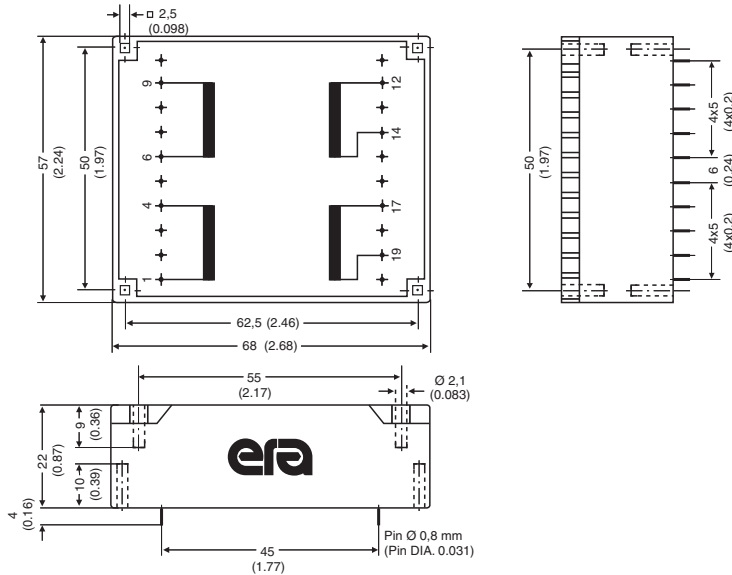

Schematics

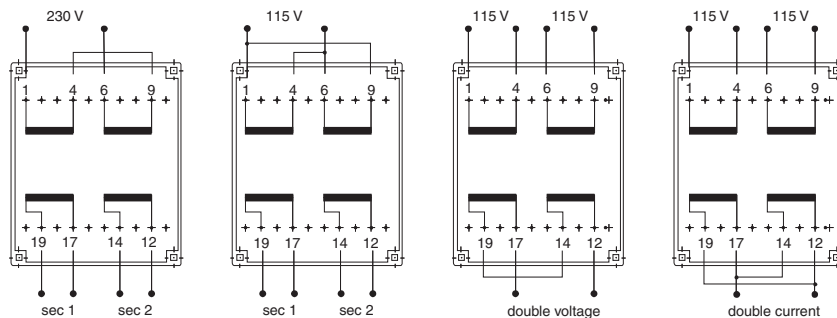

USA 858 674 8100 • Germany 49 7032 7806 0 • Singapore 65 6287 8998 • Shanghai 86 21 54643211 / 2 • China 86 769 85538070 • Taiwan 886 3 4641811

LAMINATED TRANSFORMERS

Type UI39 / 10.2 - 14VA









AGENCY APPROVALS    

1. UL 506, File E113449

3. EN61558

| Primary (V) | Secondary (V / mA) | No-Load Voltage (V) | Part Number | Agency Approvals |
|-------------|--------------------|---------------------|-------------------|------------------|
| 2x115 | 6/1166 / 6/1166 | 7.80/7.80 | 039-5095.0 | 1/3* |
| 2x115 | 9/777 / 9/777 | 11.20/11.20 | 039-5098.0 | 1/3* |
| 2x115 | 12/583 / 12/583 | 14.80/14.80 | 039-5101.0 | 1/3* |
| 2x115 | 15/466 / 15/466 | 18.80/18.80 | 039-5104.0 | 1/3* |
| 2x115 | 18/388 / 18/388 | 22.70/22.70 | 039-5107.0 | 1/3* |
| 2x115 | 21/333 / 21/333 | 24.80/24.80 | 039-5110.0 | 1/3* |

*NOTE: When checking the approval status of this product with VDE, add the prefix "BV" and the suffix "L" to the orderable Part Number (these letters will also be found on the part label). The prefix and suffix are not part of the orderable Part Number.

-  Potted under vacuum
-  Split-bobbin
-  Temperature class ta 40°C/B
-  Weight: 0.315kg
-  Packaging unit: 10 pieces (tray)
-  Fixing material for □ 2,5mm (0.098 inch)
 - Self-tapping screws: DIN 7513 (M 3x8)
 - Sheet-metal screws: DIN 7971 (2,9x6,5)

Mechanical

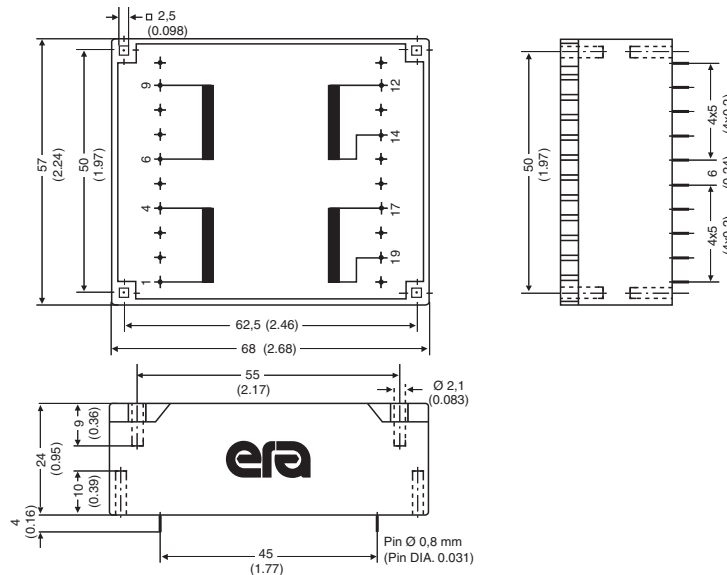

Schematics

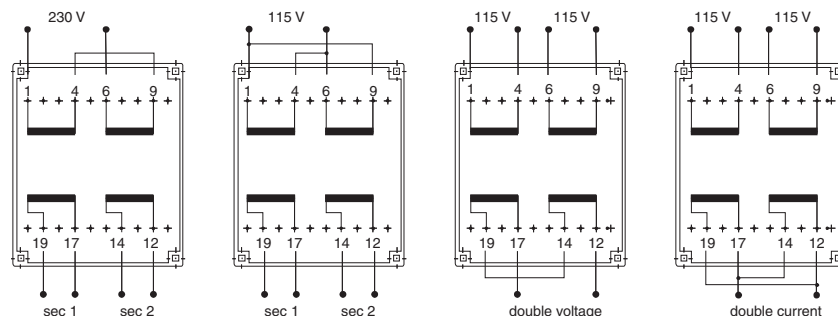

LAMINATED TRANSFORMERS

Type UI39 / 13.5 - 18VA









AGENCY APPROVALS   

1. UL 506, File E113449

3. EN61558

| Primary (V) | Secondary (V / mA) | No-Load Voltage (V) | Part Number | Agency Approvals |
|-------------|--------------------|---------------------|-------------------|------------------|
| 2x115 | 6/1500 / 6/1500 | 8.40/8.40 | 039-5164.0 | 1/3* |
| 2x115 | 9/1000 / 9/1000 | 11.60/11.60 | 039-5167.0 | 1/3* |
| 2x115 | 12/750 / 12/750 | 15.30/15.30 | 039-5170.0 | 1/3* |
| 2x115 | 15/600 / 15/600 | 19.40/19.40 | 039-5173.0 | 1/3* |
| 2x115 | 18/500 / 18/500 | 22.50/22.50 | 039-5176.0 | 1/3* |
| 2x115 | 21/428 / 21/428 | 24.60/24.60 | 039-5179.0 | 1/3* |

*NOTE: When checking the approval status of this product with VDE, add the prefix "BV" and the suffix "L" to the orderable Part Number (these letters will also be found on the part label). The prefix and suffix are not part of the orderable Part Number.

-  Frequency 50/60Hz
-  Potted under vacuum
-  Split-bobbin
-  Temperature class ta 40°C/B
-  Weight: 0.375kg
-  Packaging unit: 10 pieces (tray)
-  Fixing material for □ 2,5mm (0.098 inch)
 - Self-tapping screws: DIN 7513 (M 3x8)
 - Sheet-metal screws: DIN 7971 (2,9x6,5)

Mechanical

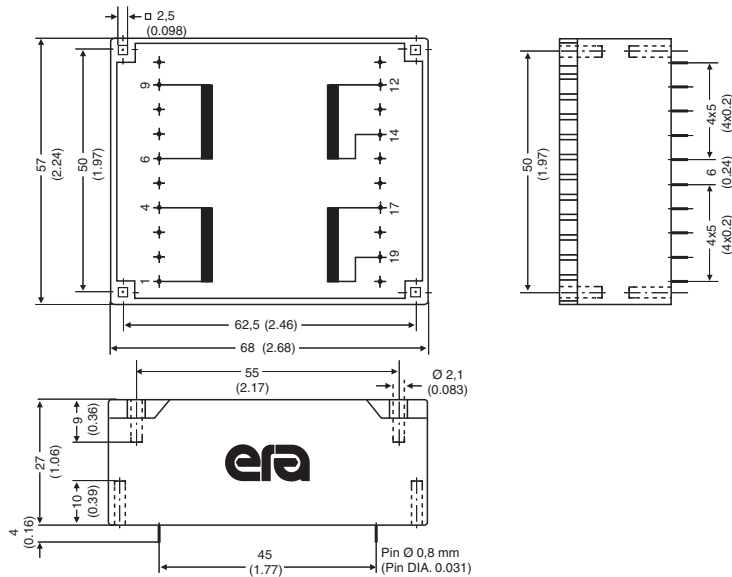

Schematics

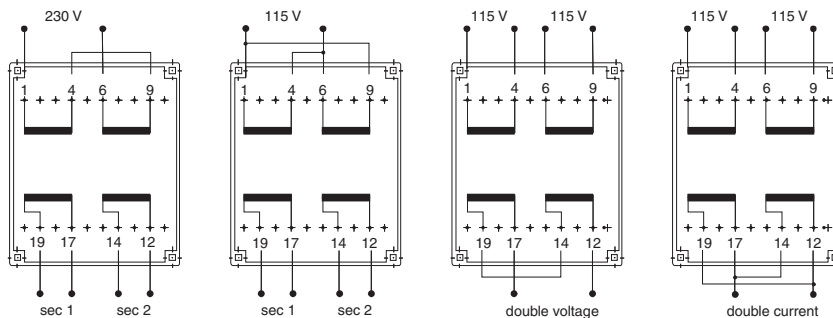

USA 858 674 8100 • Germany 49 7032 7806 0 • Singapore 65 6287 8998 • Shanghai 86 21 54643211 / 2 • China 86 769 85538070 • Taiwan 886 3 4641811

LAMINATED TRANSFORMERS

Type UI39 / 17 - 24VA









AGENCY APPROVALS   

1. UL 506, File E113449 

3. EN61558 

| Primary (V) | Secondary (V / mA) | No-Load Voltage (V) | Part Number | Agency Approvals |
|-------------|--------------------|---------------------|-------------------|------------------|
| 2x115 | 6/2000 / 6/2000 | 8.10/8.10 | 039-5233.0 | 1/3* |
| 2x115 | 9/1333 / 9/1333 | 11.10/11.10 | 039-5236.0 | 1/3* |
| 2x115 | 12/1000 / 12/1000 | 14.40/14.40 | 039-5239.0 | 1/3* |
| 2x115 | 15/800 / 15/800 | 19.20/19.20 | 039-5242.0 | 1/3* |
| 2x115 | 18/666 / 18/666 | 22.10/22.10 | 039-5245.0 | 1/3* |
| 2x115 | 21/571 / 21/571 | 24.70/24.70 | 039-5248.0 | 1/3* |

*NOTE: When checking the approval status of this product with VDE, add the prefix "BV" and the suffix "L" to the orderable Part Number (these letters will also be found on the part label). The prefix and suffix are not part of the orderable Part Number.

-  Frequency 50/60Hz
-  Weight: 0.445kg
-  Potted under vacuum
-  Packaging unit: 10 pieces (tray)
-  Split-bobbin
-  Fixing material for □ 2,5mm (0.098 inch)
-  Temperature class ta 40°C/B
- Self-tapping screws: DIN 7513 (M 3x8)
 - Sheet-metal screws: DIN 7971 (2,9x6,5)

Mechanical

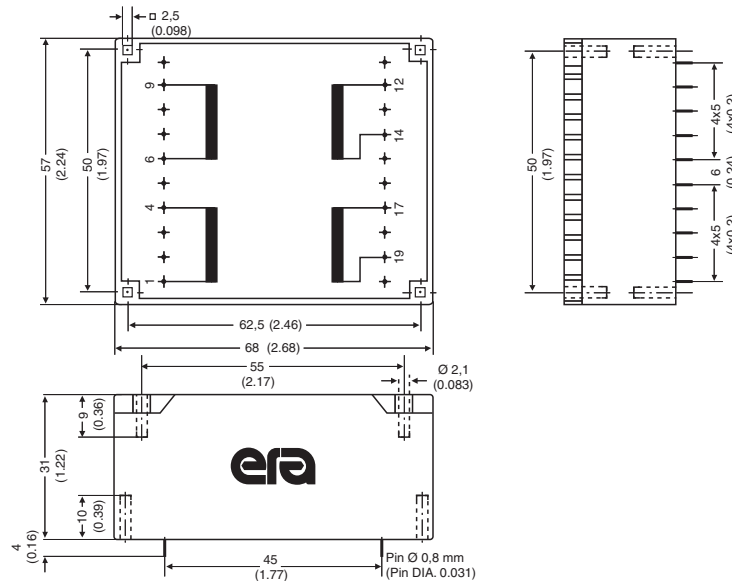

Schematics

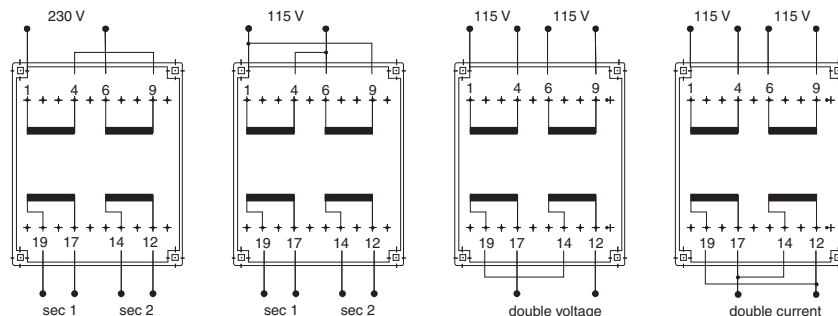

USA 858 674 8100 • Germany 49 7032 7806 0 • Singapore 65 6287 8998 • Shanghai 86 21 54643211 / 2 • China 86 769 85538070 • Taiwan 886 3 4641811



LAMINATED TRANSFORMERS

Type UI39 / 21 - 30VA









AGENCY APPROVALS 

1. UL 506, File E113449 

3. EN61558  

| Primary (V) | Secondary (V / mA) | No-Load Voltage (V) | Part Number | Agency Approvals |
|-------------|--------------------|---------------------|-------------------|------------------|
| 2x115 | 6/2500 / 6/2500 | 6.70/6.70 | 039-5302.0 | 1/3* |
| 2x115 | 9/1666 / 9/1666 | 10.30/10.30 | 039-5305.0 | 1/3* |
| 2x115 | 12/1250 / 12/1250 | 13.80/13.80 | 039-5308.0 | 1/3* |
| 2x115 | 15/1000 / 15/1000 | 17.20/17.20 | 039-5311.0 | 1/3* |
| 2x115 | 18/833 / 18/833 | 20.60/20.60 | 039-5314.0 | 1/3* |
| 2x115 | 21/714 / 21/714 | 23.50/23.50 | 039-5317.0 | 1/3* |

*NOTE: When checking the approval status of this product with VDE, add the prefix "BV" and the suffix "L" to the orderable Part Number (these letters will also be found on the part label). The prefix and suffix are not part of the orderable Part Number.

-  Frequency 50/60Hz
-  Potted under vacuum
-  Split-bobbin
-  Temperature class ta 40°C/B
-  Weight: 0.53kg
-  Packaging unit: 10 pieces (tray)
-  Fixing material for \square 2,5mm (0.098 inch)
 - Self-tapping screws: DIN 7513 (M 3x8)
 - Sheet-metal screws: DIN 7971 (2,9x6,5)

Mechanical

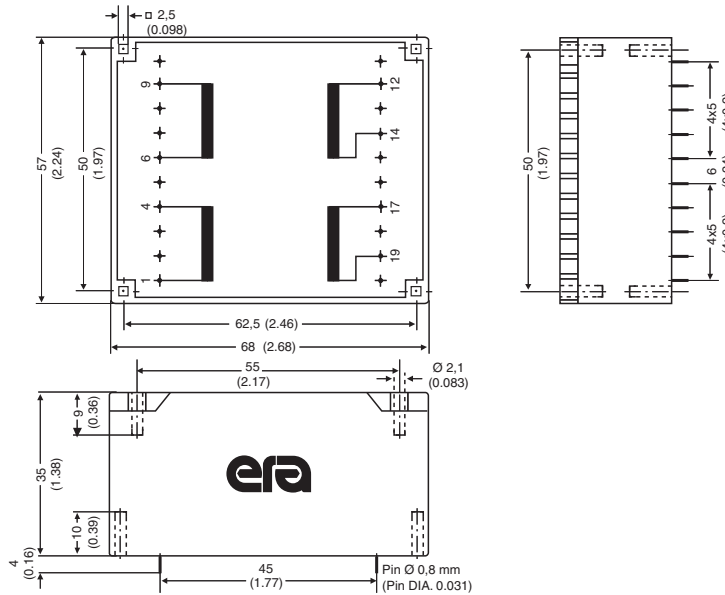

Schematics

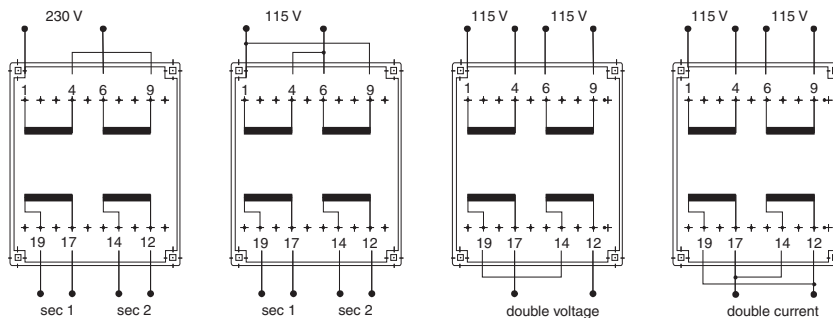

USA 858 674 8100 • Germany 49 7032 7806 0 • Singapore 65 6287 8998 • Shanghai 86 21 54643211 / 2 • China 86 769 85538070 • Taiwan 886 3 4641811

LAMINATED TRANSFORMERS

Type EI48 / 16.8 (AC)



- ⊕ Potted under vacuum
- ⊕ Split-bobbin
- ⊕ Temperature class ta 40°C/B
- ⊕ Non-inherently short circuit proof with integrated thermal fuse
- ⊕ Connection via lead wire with ferrule
- ⊕ Wire length: 150mm
- ⊕ Weight: 0.3kg
- ⊕ Packaging unit: 8 pieces (tray)

| Part Number | Primary (V) | Secondary (V _{AC} / mA) | No-Load Voltage (V) |
|-------------|-------------|----------------------------------|---------------------|
| 048-0738.4 | 230 | 8/1250 | 10.50 |

Type EI48 / 16.8 (DC)



- ⊕ Potted under vacuum
- ⊕ Split-bobbin
- ⊕ Temperature class ta 40°C/B
- ⊕ Integrated rectifier
- ⊕ Non-inherently short circuit proof with integrated thermal fuse
- ⊕ Connection via lead wire with ferrule
- ⊕ Wire length: 150mm
- ⊕ Weight: 0.3kg
- ⊕ Packaging unit: 8 pieces (tray)

| Part Number | Primary (V) | Secondary (V _{DC} / mA) | No-Load Voltage (V) |
|-------------|-------------|----------------------------------|---------------------|
| 048-0739.4 | 230 | 12/700 | 27.50 |
| 048-0740.4 | 230 | 24/350 | 46.00 |

LAMINATED TRANSFORMERS

Type EI66 / 23



- ⊕ Potted under vacuum
- ⊕ Split-bobbin
- ⊕ Temperature class ta 40°C/B
- ⊕ Integrated rectifier
- ⊕ Non-inherently short circuit proof with integrated thermal fuse
- ⊕ Connection via lead wire with ferrule
- ⊕ Wire length: 150mm
- ⊕ DIN-rail mounting
- ⊕ Weight: 1.0kg
- ⊕ Packaging unit: 4 pieces (tray)

| Part Number | Primary (V) | Secondary (Vdc / mA) | No-Load Voltage (V) |
|-------------|-------------|----------------------|---------------------|
| 066-0329.4 | 230 | 12/2000 | 18.00 |
| 066-0330.4 | 230 | 24/1000 | 36.50 |

Type EI84 / 29.5







- ⊕ Potted under vacuum
- ⊕ Split-bobbin
- ⊕ Temperature class ta 40°C/B
- ⊕ Integrated rectifier
- ⊕ Connection via lead wire with ferrule
- ⊕ Wire length: 150mm
- ⊕ DIN-rail mounting
- ⊕ Weight: 1.94kg
- ⊕ Packaging unit: 4 pieces (tray)

| Part Number | Primary (V) | Secondary (Vdc / mA) | No-Load Voltage (V) |
|-------------|-------------|----------------------|---------------------|
| 084-0082.0 | 230 | 12/5000 | 18.00 |
| 084-0083.0 | 230 | 24/2500 | 35.50 |

IGNITION TRANSFORMERS

Spark-Line - 233mH - 375mH



-  Compact Design
-  Available up to 23kV
-  Ambient Temperature 70°C
-  Weight: 0.018kg
-  Packaging unit: 55 pieces (tray)

| Part Number | Primary Resistance (±10%) (Pin 1-2) | Secondary Resistance (±10%) (Pin 3-4) | Primary Inductance (±15%) (Pin 1-2) | Secondary Inductance (±15%) (Pin 3-4) | Winding Ratio | Secondary Voltage @ load 30pF | Ambient Temperature | No-Load Operation (MAX) |
|-------------|--|--|--|--|---------------|-------------------------------|---------------------|-------------------------|
| 125-0028.0 | 26mΩ | 520Ω | 6μH | 240mH | 1:200 | >22kV | 70°C | 30s |
| 125-0031.0 | 26mΩ | 786Ω | 6μH | 375mH | 1:256 | >20kV | 70°C | 30s |
| 125-0033.0 | 59mΩ | 822Ω | 12μH | 340mH | 1:175 | >23kV | 70°C | 30s |
| 125-0039.0 | 59mΩ | 590Ω | 12μH | 233mH | 1:150 | >23kV | 70°C | 30s |

Mechanical

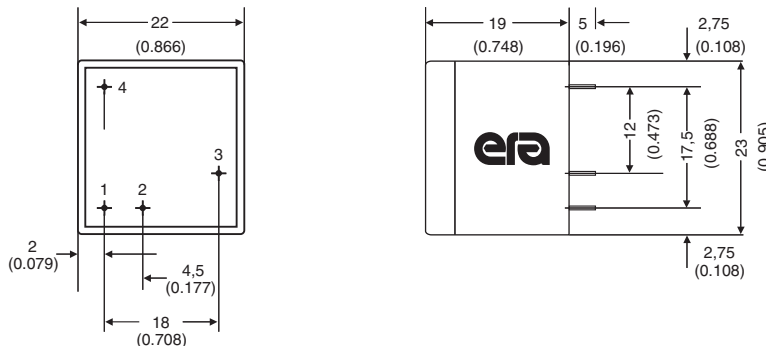



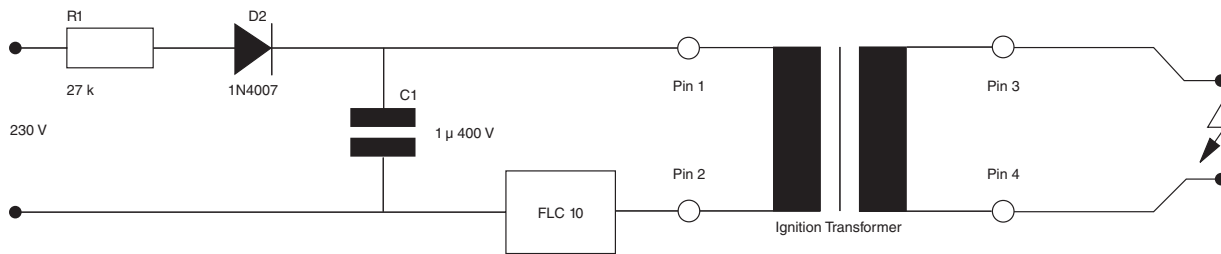

Schematic



IGNITION TRANSFORMERS

Spark-Line - Secondary External (1x)



-  Compact Design
-  Available up to 22kV
-  Ambient Temperature 70°C
-  Weight: 0.019kg
-  Packaging unit: 45 pieces (tray)

| Part Number | Primary Resistance (±10%) (Pin 1-2) | Secondary Resistance (±10%) (Pin 3-6) | Primary Inductance (±15%) (Pin 1-2) | Secondary Inductance (±15%) (Pin 3-6) | Winding Ratio | Secondary Voltage @ load 30pF | Ambient Temperature | No-Load Operation (MAX) |
|-------------|---|---|---|---|---------------|----------------------------------|---------------------|-------------------------|
| 125-0032.0 | 26mΩ | 520Ω | 6μH | 240mH | 1:200 | >22kV | 70°C | 30s |

Mechanical

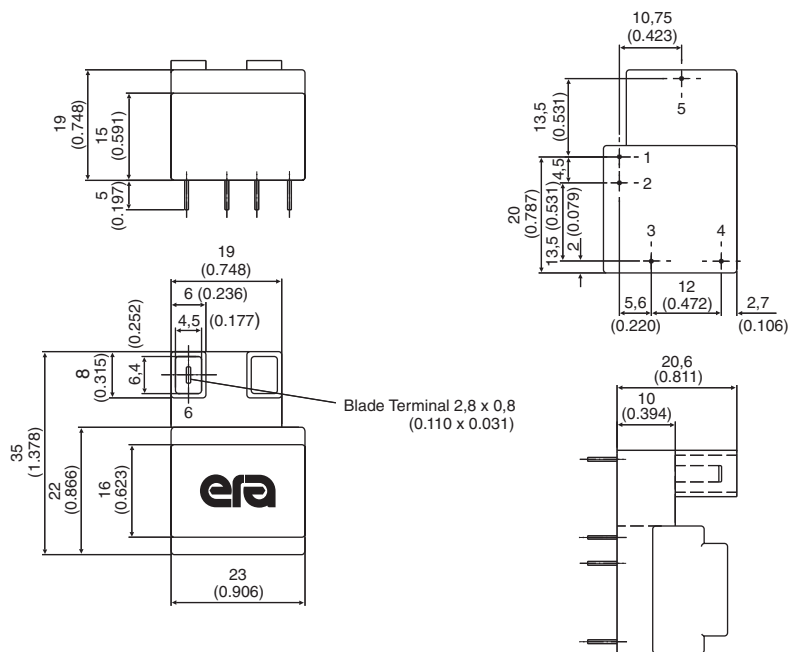

Schematic

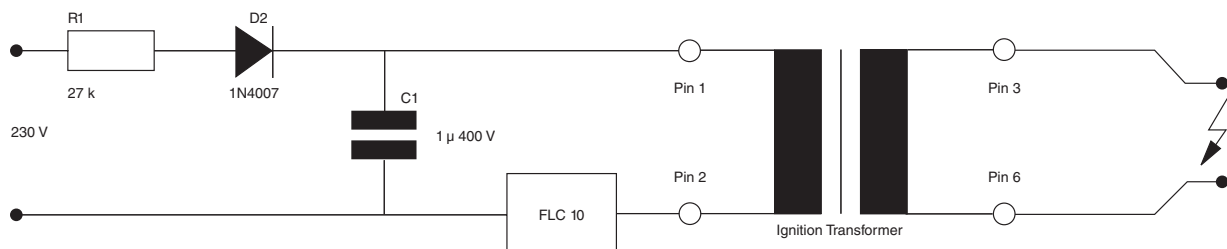

IGNITION TRANSFORMERS

Spark-Line - Secondary External (2x)



- Compact Design
- Available up to 23kV
- Ambient Temperature 70°C
- Weight: 0.018kg
- Packaging unit: 45 pieces (tray)

| Part Number | Primary Resistance (±10%) (Pin 1-2) | Secondary Resistance (±10%) (Pin 6-7) | Primary Inductance (±15%) (Pin 1-2) | Secondary Inductance (±15%) (Pin 6-7) | Winding Ratio | Secondary Voltage @ load 30pF | Ambient Temperature | No-Load Operation (MAX) |
|-------------|--|--|--|--|---------------|-------------------------------|---------------------|-------------------------|
| 125-0035.0 | 26mΩ | 520Ω | 6μH | 240mH | 1:200 | >22kV | 70°C | 30s |
| 125-0049.0 | 59mΩ | 822Ω | 12μH | 340mH | 1:175 | >23kV | 70°C | 30s |

Mechanical

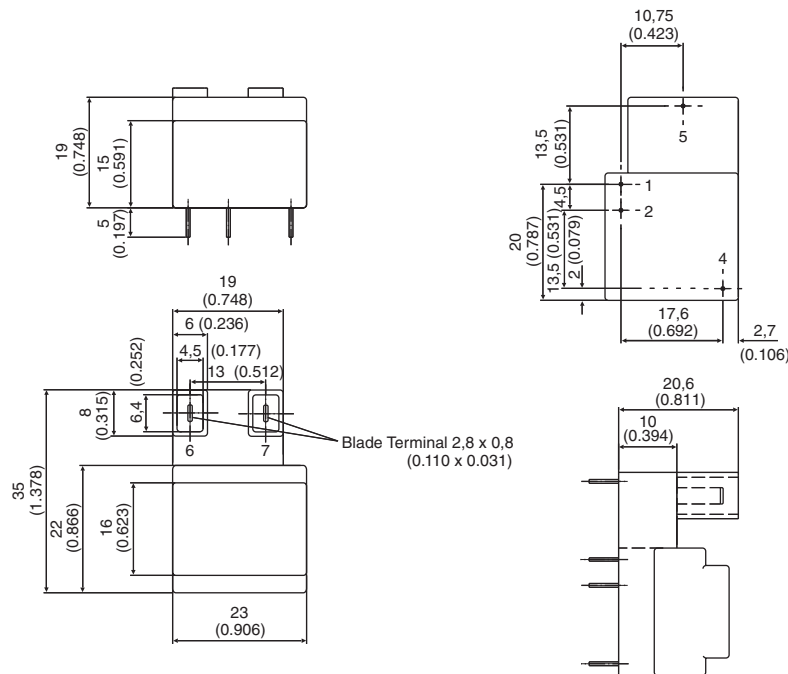

Schematic

