

## ISM BAND FSK TRANSMITTER MODULE

### RFM02

(the purpose of this spec covers mainly for the physical characteristic of the module, for register configure and its related command info please refer to [RF02 data sheets](#))

### General Introduction

RFM02 is a low costing ISM band transmitter module implemented with unique PLL approach. It works with FSK modulated signal ranges from 433/868/915MHZ bands, comply with FCC, ETSI regulation. The SPI interface is used to communicate with microcontroller for parameter setting. RFM02 works with RFM01 receiver module. At 433MHZ band, the pair of module can work up to 300m in the free open air.

RFM02



### Features:

- Low costing, high performance and price ratio
- Tuning free during production
- FSK transmission
- PLL employed
- Fast PLL lock time
- High resolution PLL with 2.5 KHz step
- Programmable frequency deviation (from 30 kHz to 210 kHz, step 30 kHz)
- Programmable output power
- High data rate (up to 115.2 kbps with FSK modulation)
- Differential antenna output
- Automatic antenna tuning
- SPI interface
- Clock and reset signal output for external MCU use
- 10MHz crystal for PLL reference
- Programmable crystal load capacitor bank
- Wakeup timer
- low battery detection
- 2.2V - 5.4V power supply
- Low power consumption
- stand by current less than 0.3 $\mu$ A

## Typical Application:

- Remote control
- Remote sensor
- Wireless data collection
- Home security system
- Toys
- Tire pressure monitoring system

## Pin Definition:

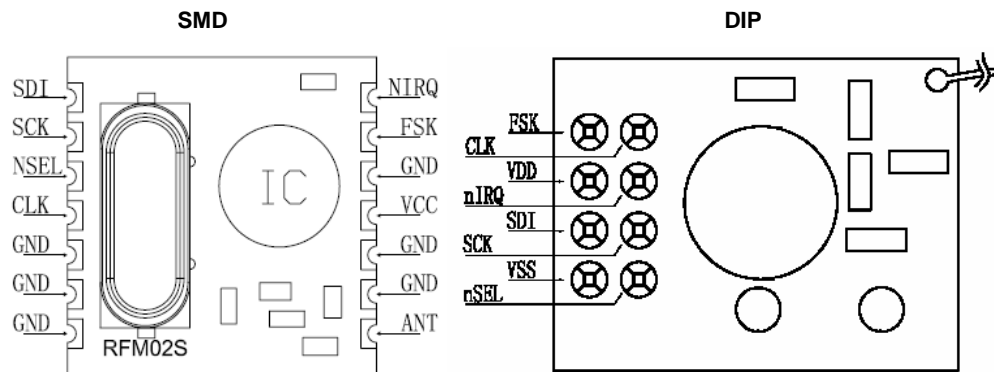

Definition	TYPE	function
FSK	DI	FSK data input
CLK	DO	clock out for MCU (1 MHz-10 MHz)
VDD	S	Positive power supply
nIRQ	DO	Interrupts request output ( active low )
SDI	DI	SPI data input
SCK	DI	SPI clock input
VSS	S	negative power supply, GND
nSEL	DI	Chip select (active low)

## Electrical Specification:

### Maximum (not at working mode)

symbol	parameter	min	max	unit
V <sub>dd</sub>	Positive power supply	-0.5	6.0	V
V <sub>in</sub>	All pin input level	-0.5	V <sub>dd</sub> +0.5	V
I <sub>in</sub>	Input current except power	-25	25	mA
ESD	Human body model		1000	V
T <sub>st</sub>	Storage temperature	-55	125	°C
T <sub>ld</sub>	Soldering temperature(10s)		260	°C

### Recommended working range

symbol	parameter	min	max	unit
V <sub>dd</sub>	Positive power supply	2.2	5.4	V
T <sub>op</sub>	operation temperature	-40	85	°C

### DC Characteristics:

symbol	parameter	conditions/note	min	typ	max	unit
I <sub>dd_TX_0</sub>	current consumption	433 MHz band	0 dBm power output	12		mA
		868 MHz band		14		
		915 MHz band		15		
I <sub>dd_TX_PMAX</sub>	current consumption	433 MHz band	max power output	23		mA
		868 MHz band		25		
		915 MHz band		26		
I <sub>pd</sub>	sleep mode current	all blocks off		0.3		μA
I <sub>wt</sub>	waek-up timer current consumption			1.5		μA
I <sub>lb</sub>	low battery detector current consumption			0.5		μA
I <sub>x</sub>	idle mode current	only crystal work		1.5		mA
V <sub>lba</sub>	low battery detection accuracy			75		mV
V <sub>lb</sub>	low battery detection range	0.1V step	2.2		5.3	V
V <sub>il</sub>	Low level input				0.3*V <sub>dd</sub>	V
V <sub>ih</sub>	High level input		0.7*V <sub>dd</sub>			V
I <sub>il</sub>	Leakage current	V <sub>il</sub> = 0 V	-1		1	μA
I <sub>ih</sub>	Leakage current	V <sub>ih</sub> = V <sub>dd</sub> , V <sub>dd</sub> = 5.4V	-1		1	μA
V <sub>ol</sub>	Low level output	I <sub>ol</sub> = 2 mA			0.4	V
V <sub>oh</sub>	High level output	I <sub>oh</sub> = -2 mA	V <sub>dd</sub> -0.4			V

### DC Characteristics:

symbol	parameter	conditions/notes	min	typ	max	unit
$f_{ref}$	PLL reference frequency	Parallel fundamental	9	10	11	MHz
$f_o$	Output frequency ( $f_{ref}=10\text{MHz}$ )	433MHz band,2.5kHz step 868MHz band,5.0kHz step 915MHz band,7.5kHz step	430.24 860.48 900.72		439.75 879.51 929.27	MHz
$f_o$	Output frequency ( $f_{ref}=9\text{MHz}$ )	433MHz band,2.5kHz step 868MHz band,5.0kHz step 915MHz band,7.5kHz step	387.22 774.43 810.65		395.76 791.56 836.34	MHz
$f_o$	Output frequency( $f_{ref}=11\text{MHz}$ )	433MHz band,2.5kHz step 868MHz band,5.0kHz step 915MHz band,7.5kHz step	473.26 946.53 990.79		483.73 967.46 1022.2	MHz
$t_{lock}$	PLL lock time	After 10MHz step hopping, frequency error <10 kHz		20		$\mu\text{s}$
$t_{sp}$	PLL start time	After crystal stabilized			250	$\mu\text{s}$
$P_{max}$	Max available output power	433MHz band	5	7		dBm
		868MHz band	2	4		
		915MHz band	2	4		
$C_o$	output capacitance(set by antenna tuning circuit)	low bands high bands	1.5 1.6	2.3 2.2	3.1 2.8	pF
$Q_o$	Q factor of output capacitance		16	18	22	
$BR_{FSK}$	FSK data rate				115.2	kbps
$df_{fsk}$	FSK deviation	30KHz step	30KHz		210	KHz
$C_{xl}$	crystal load capacitance	0.5pF step,tolerance +/-10%	8.5		16	pF
$t_{PBt}$	period of wake-up timer clock	calibrated evry 30 seconds	0.95		1.05	ms
$t_{wake-up}$	wake-up time(programable)		1		$2*10E9$	ms
$t_{POR}$	internal POR time	after power reached 90% VDD			100	ms
$t_{sx}$	Crystal start time	ESR < 100 ohms			5	ms

### Field testing range

operation band	condition	range
433MHz band	Bandwidth=134KHz, data rate=1.2kbps Frequency deviation=60KHZ ( matches with RFM01 ) in free open area	>200m
868MHz band	Bandwidth=134KHz, data rate=1.2kbps Frequency deviation=60KHZ ( matches with RFM01 ) in free open area	>200m
915MHz band	Bandwidth=134KHz, data rate=1.2kbps Frequency deviation=60KHZ ( matches with RFM01 ) in free open area	>200m

Tel: +86-755-82973805 Fax: +86-755-82973550 E-mail: [sales@hoperf.com](mailto:sales@hoperf.com) <http://www.hoperf.com>

### SGS Reports

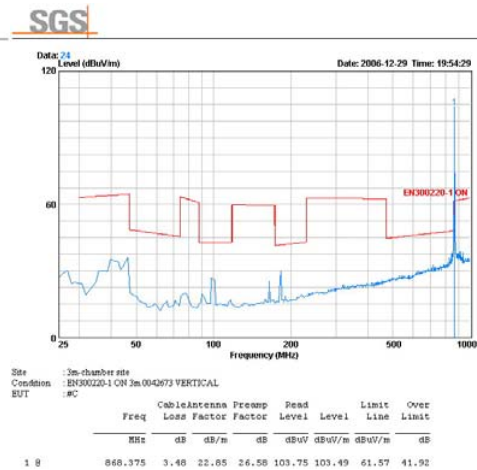
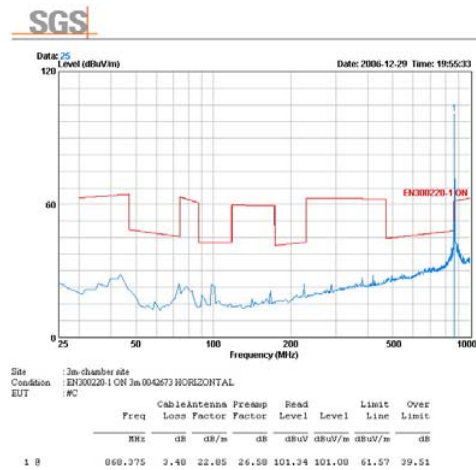
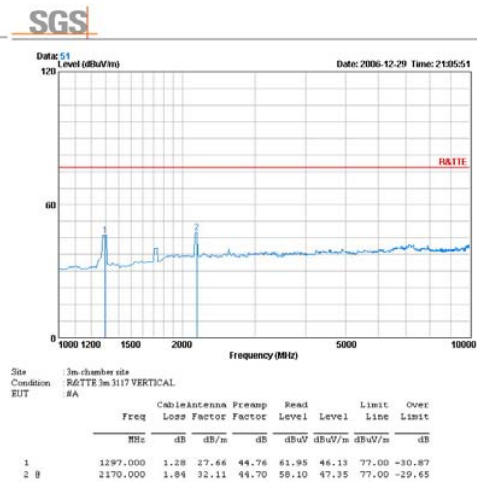
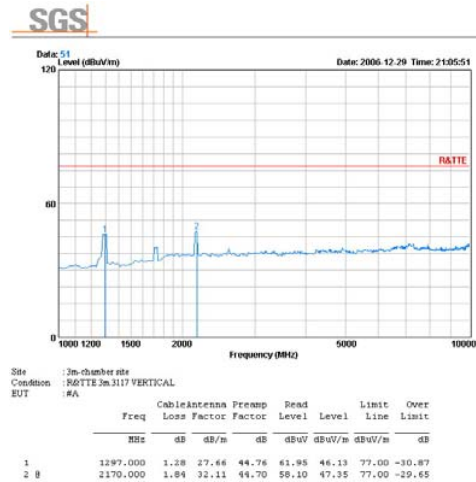
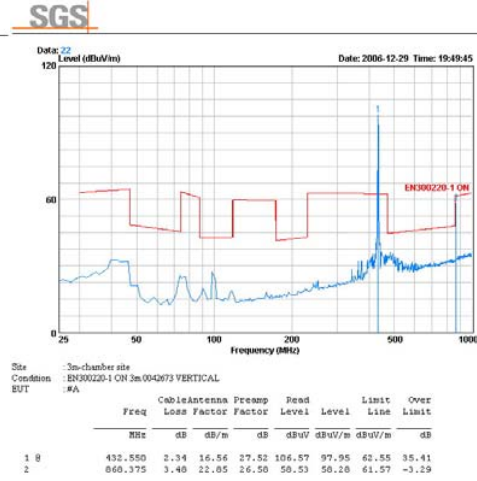
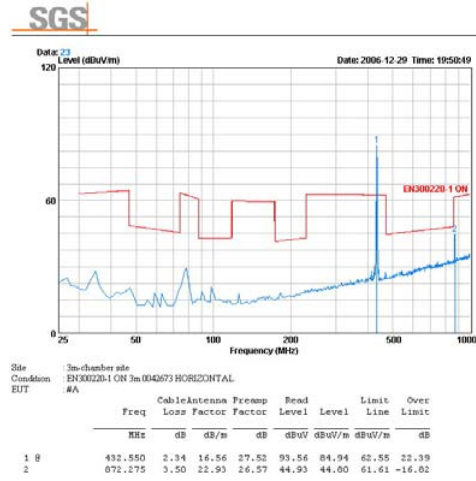

SGS

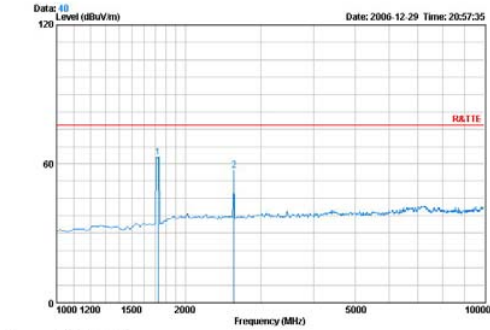

Site : 3m chamber site  
Condition : R&TTE 3m 3117 HORIZONTAL  
EUT : #C

	Freq	CableAntenna Loss Factor	Preamp Factor	Read Level	Limit Level	Over Line
	MHz	dB	dB/m	dB	dBuV	dBuV/m
1	1729.000	1.59	29.86	44.70	76.11	62.86 77.00 -14.14
2	2602.000	2.04	32.54	44.60	67.38	57.16 77.00 -19.84

SGS

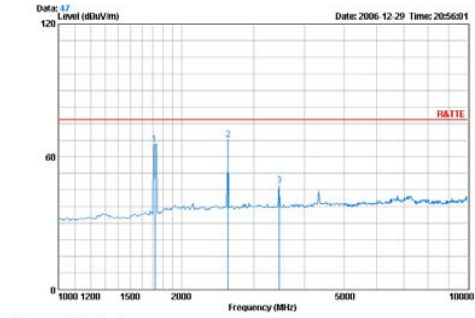

Site : 3m chamber site  
Condition : R&TTE 3m 3117 VERTICAL  
EUT : #C

	Freq	CableAntenna Loss Factor	Preamp Factor	Read Level	Limit Level	Over Line
	MHz	dB	dB/m	dB	dBuV	dBuV/m
1	1720.000	1.59	29.82	44.70	78.87	65.58 77.00 -11.42
2	2602.000	2.04	32.54	44.60	70.13	67.91 77.00 -9.09
3	3466.000	2.35	33.21	45.01	56.47	47.02 77.00 -29.98

SGS

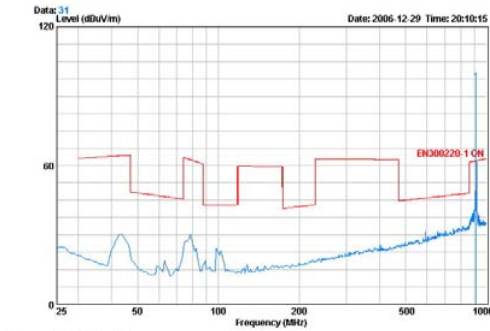

Site : 3m chamber site  
Condition : EN300220-1 CH 3m 004073 HORIZONTAL  
EUT : #E

	Freq	CableAntenna Loss Factor	Preamp Factor	Read Level	Limit Level	Over Line
	MHz	dB	dB/m	dB	dBuV	dBuV/m
1	914.200	3.62	23.26	26.43	95.64	96.09 62.05 34.04

SGS

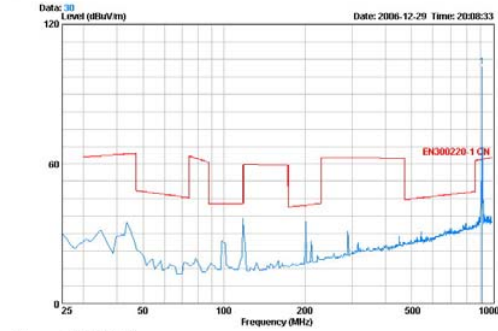

Site : 3m chamber site  
Condition : EN300220-1 CH 3m 004073 VERTICAL  
EUT : #E

	Freq	CableAntenna Loss Factor	Preamp Factor	Read Level	Limit Level	Over Line
	MHz	dB	dB/m	dB	dBuV	dBuV/m
1	914.200	3.62	23.26	26.43	101.18	101.63 62.05 39.57

SGS

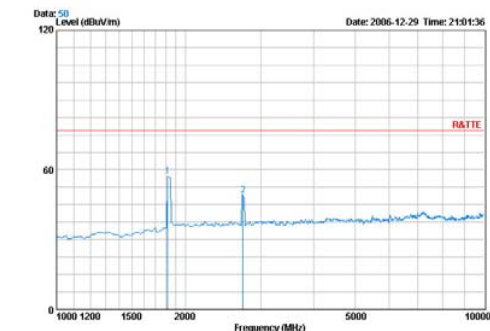

Site : 3m chamber site  
Condition : R&TTE 3m 3117 HORIZONTAL  
EUT : #E

	Freq	CableAntenna Loss Factor	Preamp Factor	Read Level	Limit Level	Over Line
	MHz	dB	dB/m	dB	dBuV	dBuV/m
1	1819.000	1.45	30.41	44.69	69.51	67.09 77.00 -19.91
2	2728.000	2.09	32.82	44.84	58.95	49.03 77.00 -27.97

SGS

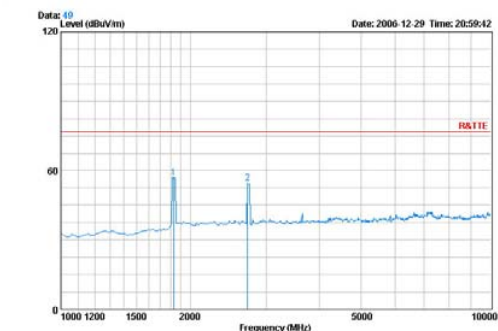

Site : 3m chamber site  
Condition : R&TTE 3m 3117 VERTICAL  
EUT : #E

	Freq	CableAntenna Loss Factor	Preamp Factor	Read Level	Limit Level	Over Line
	MHz	dB	dB/m	dB	dBuV	dBuV/m
1	1828.000	1.66	30.70	44.69	69.20	56.87 77.00 -20.13
2	2719.000	2.09	32.01	44.03	64.43	54.49 77.00 -22.51

## Mechanical Dimension:

(all dimensions in mm)

### SMD PACKAGE (S1)

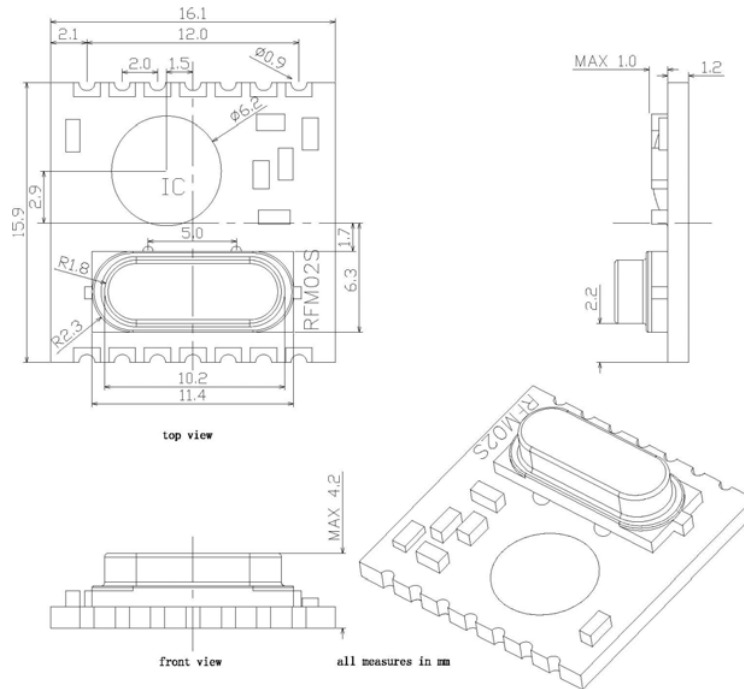

### SMD PACKAGE (S2)

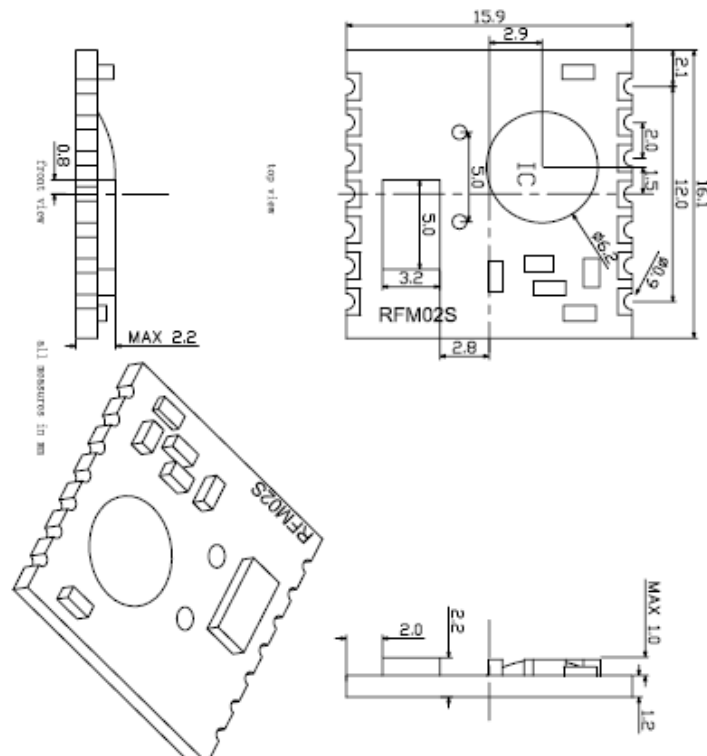

### DIP PACKAGE (D)

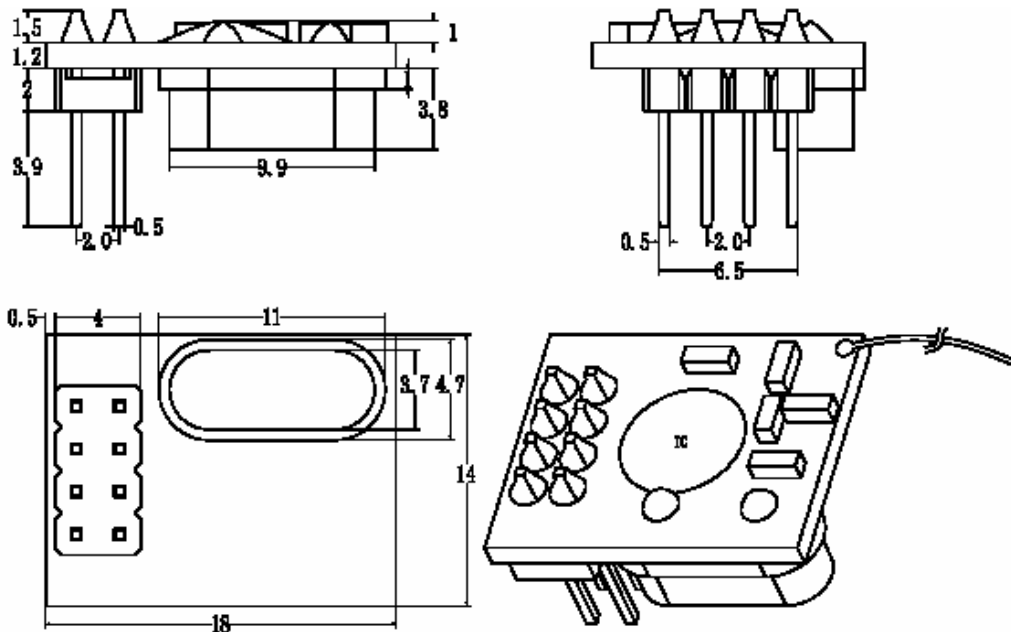

## Module Definition

model=module-operation\_band-package\_type

**RFM02B-433-D**

module type

operation band

Package

eg: 1, RFM02 module at 433MHz band, DIP : RFM02-433-D.

2, RFM02 module at 868MHz band, SMD, thickness at 4.2mm : RFM02-868-S1.

<p><b>HOPE MICROELECTRONICS CO.,LTD</b>          Add:4/F, Block B3, East Industrial Area,          Huaqiaocheng, Shenzhen, Guangdong,          China          Tel: 86-755-82973805          Fax: 86-755-82973550          Email: <a href="mailto:sales@hoperf.com">sales@hoperf.com</a>  <a href="mailto:trade@hoperf.com">trade@hoperf.com</a>          Website: <a href="http://www.hoperf.com">http://www.hoperf.com</a>  <a href="http://www.hoperf.cn">http://www.hoperf.cn</a>  <a href="http://hoperf.en.alibaba.com">http://hoperf.en.alibaba.com</a></p>	<p>This document may contain preliminary information and is subject to change by Hope Microelectronics without notice. Hope Microelectronics assumes no responsibility or liability for any use of the information contained herein. Nothing in this document shall operate as an express or implied license or indemnity under the intellectual property rights of Hope Microelectronics or third parties. The products described in this document are not intended for use in implantation or other direct life support applications where malfunction may result in the direct physical harm or injury to persons. NO WARRANTIES OF ANY KIND, INCLUDING, BUT NOT LIMITED TO, THE IMPLIED WARRANTIES OF MECHANABILITY OR FITNESS FOR A PARTICULAR PURPOSE, ARE OFFERED IN THIS DOCUMENT.</p> <p>©2006, HOPE MICROELECTRONICS CO.,LTD. All rights reserved.</p>
---	--