

# LM49100 Boomer® Audio Power Amplifier Series

## Mono Class AB Audio Sub-System with a True-Ground Headphone Amplifier

### General Description

The LM49100 is a fully integrated audio subsystem capable of delivering 1.275W of continuous average power into a mono 8Ω bridged-tied load (BTL) with 1% THD+N and with a 5V power supply. The LM49100 also has a stereo true-ground headphone amplifier capable of 50mW per channel of continuous average power into a 32Ω single-ended (SE) loads with 1% THD+N.

The LM49100 has three input channels. One pair of SE inputs can be used with a stereo signal. The other input channel is fully differential and may be used with a mono input signal. The LM49100 features a 32-step digital volume control and ten distinct output modes. The mixer, volume control, and device mode select are controlled through an I<sup>2</sup>C compatible interface.

Thermal overload protection prevent the device from being damaged during fault conditions. Superior click and pop suppression eliminates audible transients on power-up/down and during shutdown.

### Key Specifications

- |   |                    |
|---|--------------------|
| <ul style="list-style-type: none"> <li>■ Power Output at <math>V_{DD} = 5V</math>:<br/>Loudspeaker (LS):<br/><math>R_L = 8\Omega</math>, THD+N <math>\leq 1\%</math></li> <li>Headphone (<math>V_{DDHP} = 2.8V</math>):<br/><math>R_L = 32\Omega</math>, THD+N <math>\leq 1\%</math></li> </ul> | 1.275W<br><br>50mW |
| <ul style="list-style-type: none"> <li>■ Shutdown current</li> </ul>  | 0.01μA             |

### Features

- Mono and stereo inputs
- Thermal Overload Protection
- True-ground Headphone Drivers
- I<sup>2</sup>C Control Interface
- Input mute attenuation
- 2nd Stage headphone attenuator
- 32-step digital volume control
- 10 Operating Modes
- Minimum external components
- Click and Pop suppression
- Micro-power shutdown
- Available in space-saving 3mm x 3mm 25 bump GR package
- RF Suppression

### Applications

- Mobile Phones
- PDAs
- Laptops
- Portable Electronics

# Typical Application

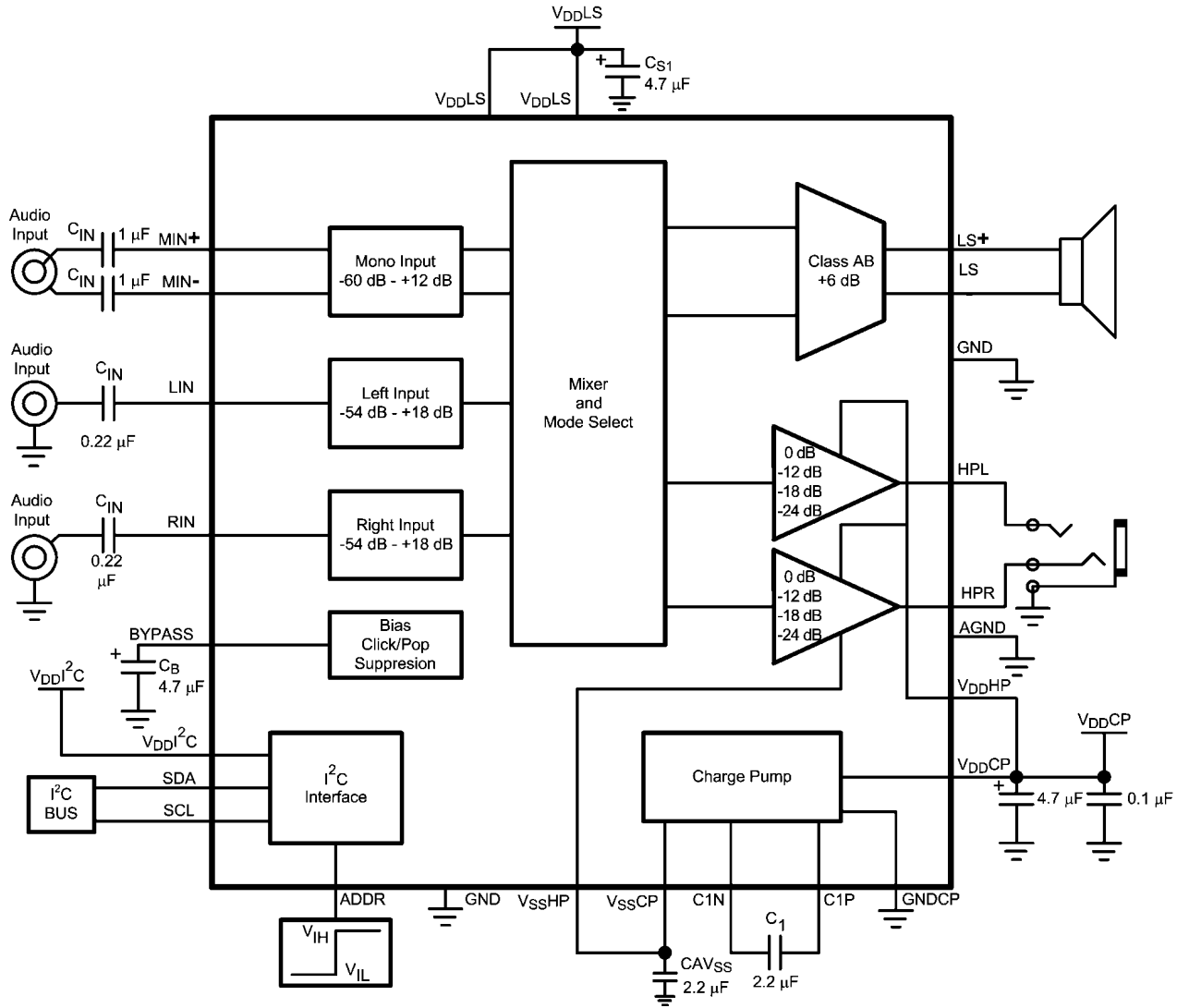

30001504

FIGURE 1. Typical Audio Amplifier Application Circuit

# Connection Diagrams

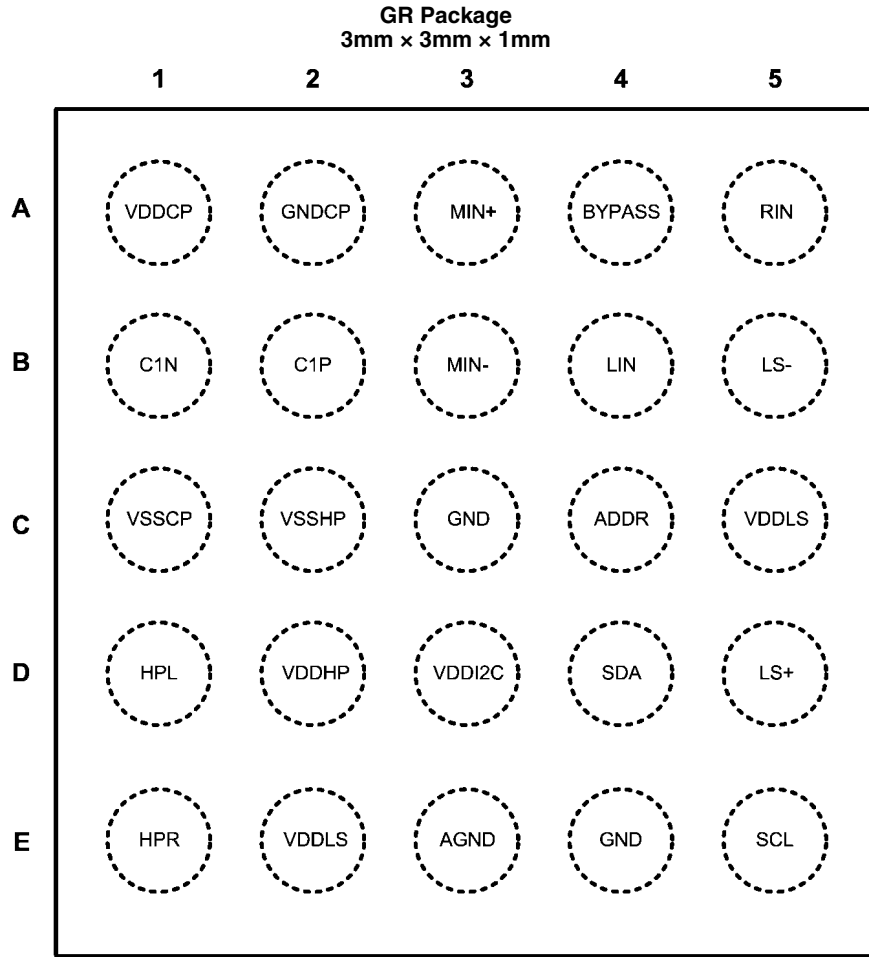

300015o3

**Top View**  
Order Number LM49100GR  
See NS Package Number GRA25A

### GR Package Marking

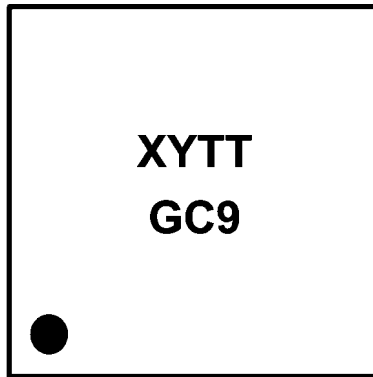

300015f6

**Top View**  
XY — 2 Digit datecode  
TT — Lot traceability  
G — Boomer Family  
C9 — LM49100GR

## Bump Descriptions

Bump	Name	Description
A1	V <sub>DD</sub> CP	Positive Charge Pump Power Supply
A2	GND <sub>CP</sub>	Charge Pump Ground
A3	MIN+	Positive Mono Input
A4	BYPASS	Half-Supply Bypass
A5	RIN	Right Input
B1	C1N	Negative Terminal – Charge Pump Flying Capacitor
B2	C1P	Positive Terminal – Charge Pump Flying Capacitor
B3	MIN-	Negative Mono Input
B4	LIN	Left Input
B5	LS-	Negative Loudspeaker Output
C1	V <sub>SS</sub> CP	Negative Charge Pump Power Supply
C2	V <sub>SS</sub> HP	Negative Headphone Power Supply
C3	GND	Ground
C4	ADDR	I <sup>2</sup> C Address Identification
C5	V <sub>DD</sub> LS	Loudspeaker Power Supply
D1	HPL	Left Headphone Output
D2	V <sub>DD</sub> HP	Positive Headphone Power Supply
D3	V <sub>DD</sub> I <sup>2</sup> C	I <sup>2</sup> C Power Supply
D4	SDA	I <sup>2</sup> C Data
D5	LS+	Loudspeaker Output Positive
E1	HPR	Right Headphone Output
E2	V <sub>DD</sub> LS	Loudspeaker Power Supply
E3	AGND	Headphone Signal Ground (See Application Information section).
E4	GND	Ground
E5	SCL	I <sup>2</sup> C Clock

**Absolute Maximum Ratings** (Notes 1, 2)

If Military/Aerospace specified devices are required, please contact the National Semiconductor Sales Office/Distributors for availability and specifications.

Supply Voltage (Loudspeaker)	6V
Supply Voltage (Headphone)	3V
Storage Temperature	-65°C to +150°C
Input Voltage	-0.3V to $V_{DD} + 0.3V$
Power Dissipation (Note 3)	Internally Limited
ESD Susceptibility (Note 4)	2000V
ESD Susceptibility (Note 5)	200V
Junction Temperature	150°C

Thermal Resistance

 $\theta_{JA}$  (GR)

50.2°C/W

**Operating Ratings**

Temperature Range

 $T_{MIN} \leq T_A \leq T_{MAX}$  $-40^\circ\text{C} \leq T_A \leq +85^\circ\text{C}$ Supply Voltage  $V_{DDLS}$  $2.7V \leq V_{DDLS} \leq 5.5V$ Supply Voltage  $V_{DDHP}$  $2.4V \leq V_{DDHP} \leq 2.9V$ I<sup>2</sup>C Voltage ( $V_{DDI^2C}$ ) $1.7V \leq V_{DDI^2C} \leq 5.5V$  $V_{DDHP} \leq V_{DDLS}$  $V_{DDI^2C} \leq V_{DDLS}$ **Electrical Characteristics  $V_{DDLS} = 3.6V$ ,  $V_{DDHP} = 2.8V$**  (Notes 1, 2)

The following specifications apply for all programmable gain set to 0 dB,  $C_B = 4.7\mu\text{F}$ ,  $R_{L(SP)} = 8\Omega$ ,  $R_{L(HP)} = 32\Omega$ ,  $f = 1\text{ kHz}$  unless otherwise specified. Limits apply for  $T_A = 25^\circ\text{C}$ .

Symbol	Parameter	Conditions	LM49100		Units (Limits)	
			Typical (Note 6)	Limit (Note 7)		
$I_{DD}$	Supply Current	$V_{DDLS} = 3.0V$ $V_{DDHP} = 2.8V$	Modes 1, 3, 5 $V_{IN} = 0V$ , No Load	2.9		mA
			Modes 2, 4, 6 $V_{IN} = 0V$ , No Load	3.4		mA
			Modes 7, 10, 14 $V_{IN} = 0V$ , No Load	4.8		mA
		$V_{DDLS} = 3.6V$ $V_{DDHP} = 2.8V$	Modes 1, 3, 5 $V_{IN} = 0V$ , No Load	2.9	4.3	mA (max)
			Modes 2, 4, 6 $V_{IN} = 0V$ , No Load	3.5	5.4	mA (max)
			Modes 7, 10, 14 $V_{IN} = 0V$ , No Load	4.8	7.4	mA (max)
		$V_{DDLS} = 5.0V$ $V_{DDHP} = 2.8V$	Modes 1, 3, 5 $V_{IN} = 0V$ , No Load	3.1		mA
			Modes 2, 4, 6 $V_{IN} = 0V$ , No Load	3.6		mA
			Modes 7, 10, 14 $V_{IN} = 0V$ , No Load	5.0		mA
$I_{SD}$	Shutdown Supply Current	Mode 0	0.01	1	$\mu\text{A}$ (max)	
$V_{OS}$	Output Offset Voltage	$V_{IN} = 0V$ , Mode 7, Mono	6.0	25	mV (max)	
		$V_{IN} = 0V$ , Mode 7, Headphone Gain = -24dB	2.2	5.5	mV	
		$V_{IN} = 0V$ , Mode 7, Headphone Gain = -18dB	2.4		mV (max)	
		$V_{IN} = 0V$ , Mode 7, Headphone Gain = -12dB	3.2		mV	
		$V_{IN} = 0V$ , Mode 7, Headphone Gain = 0dB	7	15	mV (max)	
$P_{OUT}$	Output Power	$V_{DDLS} = 3.0V$	LS $f = 1\text{ kHz}$	$R_L = 8\Omega$		
				1%	425	mW
				10%	525	mW
			HP $f = 1\text{ kHz}$	$R_L = 16\Omega$		
				1%	49	mW
				10%	69	mW
	$R_L = 32\Omega$					
	1%	35	mW			
	10%	44	mW			

Symbol	Parameter	Conditions		LM49100		Units (Limits)	
				Typical (Note 6)	Limit (Note 7)		
P <sub>OUT</sub>	Output Power	V <sub>DDLS</sub> = 3.6V	LS f = 1kHz	R <sub>L</sub> = 8Ω 1% 10%	640 790	600	mW (min) mW
			HP f = 1kHz	R <sub>L</sub> = 16Ω 1% 10%	49 72		mW mW
				R <sub>L</sub> = 32Ω 1% 10%	50 62	46	mW (min) mW
P <sub>OUT</sub>	Output Power	V <sub>DDLS</sub> = 5.0V	LS f = 1kHz	R <sub>L</sub> = 8Ω 1% 10%	1275 1575		mW mW
			HP f = 1kHz	R <sub>L</sub> = 16Ω 1% 10%	49 72		mW mW
				R <sub>L</sub> = 32Ω 1% 10%	53 62		mW mW
THD+N	Total Harmonic Distortion + Noise	V <sub>DDLS</sub> = 3.0V	f = 1kHz	Loudspeaker; Mode 1, R <sub>L</sub> = 8Ω, P <sub>OUT</sub> = 215mW	0.05		%
				Headphone; Mode 4, R <sub>L</sub> = 32Ω, P <sub>OUT</sub> = 25mW	0.02		%
THD+N	Total Harmonic Distortion + Noise	V <sub>DDLS</sub> = 3.6V	f = 1kHz	Loudspeaker; Mode 1, R <sub>L</sub> = 8Ω, P <sub>OUT</sub> = 320mW	0.05		%
				Headphone; Mode 4, R <sub>L</sub> = 32Ω, P <sub>OUT</sub> = 25mW	0.02		%
THD+N	Total Harmonic Distortion + Noise	V <sub>DDLS</sub> = 5.0V	f = 1kHz	Loudspeaker; Mode 1, R <sub>L</sub> = 8Ω, P <sub>OUT</sub> = 630mW	0.035		%
				Headphone; Mode 4, R <sub>L</sub> = 32Ω, P <sub>OUT</sub> = 25mW	0.02		%

Symbol	Parameter	Conditions	LM49100		Units (Limits)	
			Typical (Note 6)	Limit (Note 7)		
$e_N$	Noise	A-weighted, 0 dB, inputs terminated to GND, output referred	Headphone			
			Mode 2, 10	12		$\mu\text{V}$
			Mode 4, 7	13		$\mu\text{V}$
			Mode 6, 14	16		$\mu\text{V}$
			Loudspeaker			
			Mode 1	14		$\mu\text{V}$
			Mode 3, 7, 10, 14	23		$\mu\text{V}$
	Mode 5	27		$\mu\text{V}$		
$T_{ON}$	Turn-on Time		26		ms	
$T_{OFF}$	Turn-off Time		1		ms	
$Z_{IN}$	Input Impedance	Maximum gain setting	12.5	10 15	k $\Omega$ (min) k $\Omega$ (max)	
		Maximum attenuation setting	110	90 130	k $\Omega$ (min) k $\Omega$ (max)	
$A_V$	Volume Control	Stereo (Left and Right Channels)	Input referred maximum attenuation	-54	-52 -56	dB (min) dB (max)
			Input referred maximum gain	18	17.5 18.5	dB (min) dB (max)
		Mono	Input referred maximum attenuation	-60	-58 -62	dB (min) dB (max)
			Input referred maximum gain	12	11.5 12.5	dB (min) dB (max)
CMRR	Common Mode Rejection Ratio	Headphone Mode 2, $f = 217\text{ Hz}$ , $V_{CM} = 1 V_{PP}$ , $R_L = 32\Omega$	64		dB	
		Loudspeaker Mode 1, $f = 217\text{ Hz}$ , $V_{CM} = 1 V_{PP}$ , $R_L = 8\Omega$	58		dB	
PSRR	Power Supply Rejection Ratio	$V_{RIPPLE} = 200\text{mVpp}$ on $V_{DD}$ LS, output referred, inputs terminated to GND, $f = 217\text{ Hz}$				
		LS, Mode 1	90		dB	
		LS, Mode 3, 7, 10, 14	78		dB	
PSRR	Power Supply Rejection Ratio	LS, Mode 5	77		dB	
		$V_{RIPPLE} = 200\text{mVpp}$ on $V_{DD}$ HP, output referred, inputs terminated to GND, $f = 217\text{ Hz}$				
PSRR	Power Supply Rejection Ratio	LS, Mode 7, 10, 14	83		dB	
		$V_{RIPPLE} = 200\text{mVpp}$ on $V_{DD}$ LS, output referred, inputs terminated to GND, $f = 217\text{ Hz}$				
PSRR	Power Supply Rejection Ratio	HP, Mode 2, 10	90		dB	
		HP, Mode 4, 7	88		dB	
		HP, Mode 6, 14	87		dB	
PSRR	Power Supply Rejection Ratio	$V_{RIPPLE} = 200\text{mVpp}$ on $V_{DD}$ HP, output referred, inputs terminated to GND, $f = 217\text{ Hz}$				
		HP, Mode 2, 10	83		dB	
		HP, Mode 4, 7	83		dB	
		HP, Mode 6, 14	80		dB	

**I<sup>2</sup>C** (Notes 2, 7)

The following specifications apply for  $V_{DD} = 5.0V$  and  $3.3V$ ,  $T_A = 25^\circ C$ ,  $2.2V \leq V_{DD}^{I^2C} \leq 5.5V$ , unless otherwise specified.

Symbol	Parameter	Conditions (Note 8)	LM49100		Units (Limits)
			Typical (Note 6)	Limits (Note 7)	
$t_1$	I <sup>2</sup> C Clock Period			2.5	$\mu s$ (min)
$t_2$	I <sup>2</sup> C Data Setup Time			100	ns (min)
$t_3$	I <sup>2</sup> C Data Stable Time			0	ns (min)
$t_4$	Start Condition Time			100	ns (min)
$t_5$	Stop Condition Time			100	ns (min)
$t_6$	I <sup>2</sup> C Data Hold Time			100	ns (min)
$V_{IH}$	I <sup>2</sup> C Input Voltage High			$0.7 \times V_{DD}^{I^2C}$	V (min)
$V_{IL}$	I <sup>2</sup> C Input Voltage Low			$0.3 \times V_{DD}^{I^2C}$	V (max)

**I<sup>2</sup>C** (Notes 2, 7)

The following specifications apply for  $V_{DD} = 5.0V$  and  $3.3V$ ,  $T_A = 25^\circ C$ ,  $1.7V \leq V_{DD}^{I^2C} \leq 2.2V$ , unless otherwise specified.

Symbol	Parameter	Conditions (Note 8)	LM49100		Units (Limits)
			Typical (Note 6)	Limits (Note 7)	
$t_1$	I <sup>2</sup> C Clock Period			2.5	$\mu s$ (min)
$t_2$	I <sup>2</sup> C Data Setup Time			250	ns (min)
$t_3$	I <sup>2</sup> C Data Stable Time			0	ns (min)
$t_4$	Start Condition Time			250	ns (min)
$t_5$	Stop Condition Time			250	ns (min)
$t_6$	I <sup>2</sup> C Data Hold Time			250	ns (min)
$V_{IH}$	I <sup>2</sup> C Input Voltage High			$0.7 \times V_{DD}^{I^2C}$	V (min)
$V_{IL}$	I <sup>2</sup> C Input Voltage Low			$0.3 \times V_{DD}^{I^2C}$	V (max)

**Note 1:** All voltages are measured with respect to the GND pin unless otherwise specified.

**Note 2:** *Absolute Maximum Ratings* indicate limits beyond which damage to the device may occur. *Operating Ratings* indicate conditions for which the device is functional but do not guarantee specific performance limits. *Electrical Characteristics* state DC and AC electrical specifications under particular test conditions which guarantee specific performance limits. This assumes that the device is within the Operating Ratings. Specifications are not guaranteed for parameters where no limit is given, however, the typical value is a good indication of device performance.

**Note 3:** The maximum power dissipation must be derated at elevated temperatures and is dictated by  $T_{JMAX}$ ,  $\theta_{JA}$ , and the ambient temperature,  $T_A$ . The maximum allowable power dissipation is  $P_{DMAX} = (T_{JMAX} - T_A) / \theta_{JA}$  or the number given in Absolute Maximum Ratings, whichever is lower. For the LM49100, see power derating currents for more information.

**Note 4:** Human body model, 100 pF discharged through a 1.5k $\Omega$  resistor.

**Note 5:** Machine Model, 220pF - 240pF discharged through all pins.

**Note 6:** Typicals are measured at 25°C and represent the parametric norm.

**Note 7:** Limits are guaranteed to National's AOQL (Average Outgoing Quality Level).

**Note 8:** Please refer to Figure 3 (I<sup>2</sup>C Timing Diagram).



# Typical Performance Characteristics

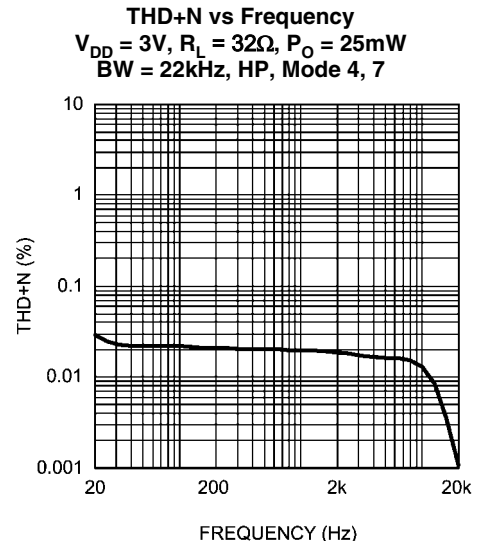
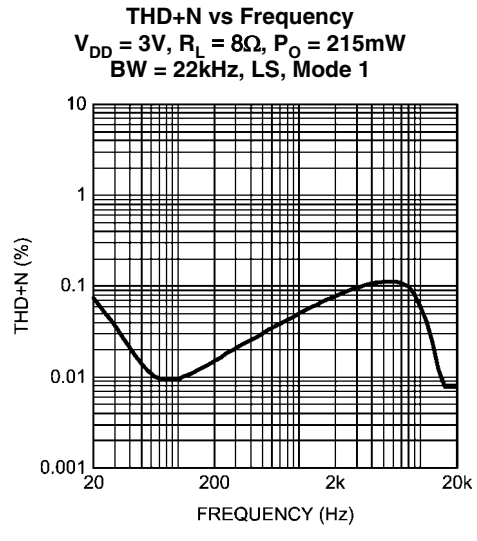
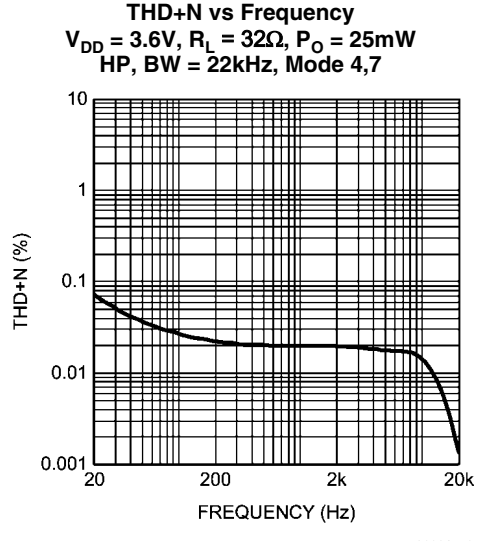
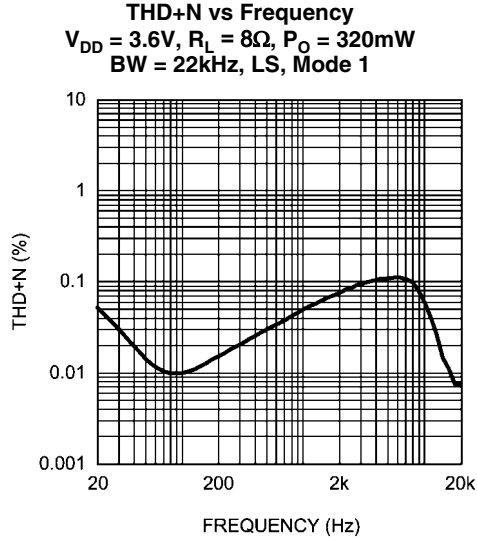

**THD+N vs Frequency**  
 $V_{DD} = 5V, R_L = 8\Omega, P_O = 630mW$   
 BW = 22kHz, Loudspeaker, Mode 1

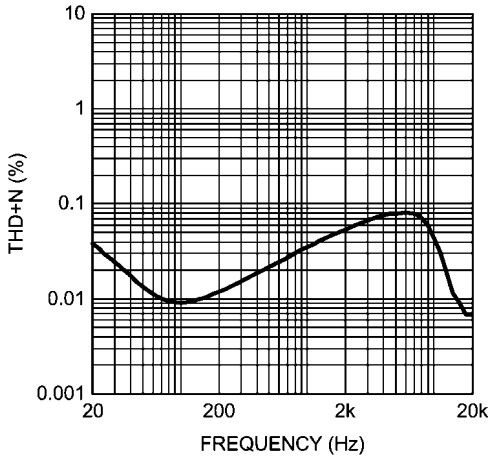

300015p1

**THD+N vs Frequency**  
 $V_{DD} = 5V, R_L = 32\Omega, P_O = 25mW$   
 BW = 22kHz, Headphone, Mode 4,7

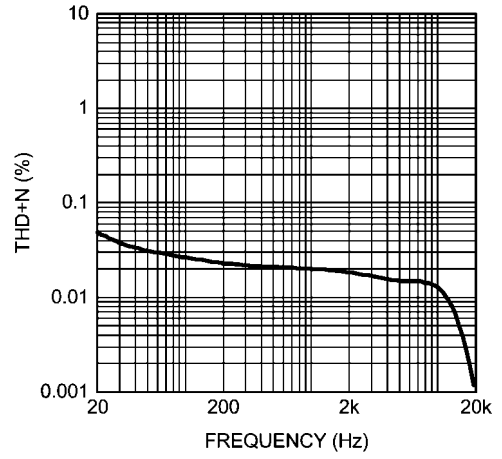

300015p2

**THD+N vs Output Power**  
 $R_L = 32\Omega, f = 1kHz$   
 BW = 22kHz, HP, Mode 4

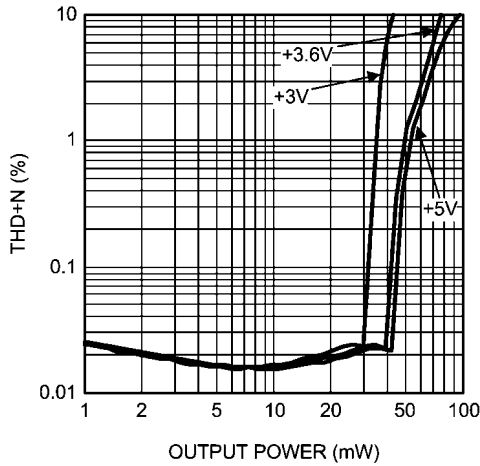

300015q0

**THD+N vs Output Power**  
 $R_L = 8\Omega, f = 1kHz$   
 BW = 22kHz, LS, Mode 1

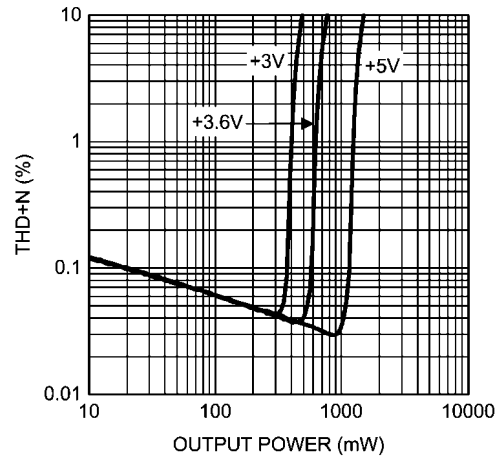

300015e7

**Output Power vs Supply Voltage**  
 $V_{DDHP} = 2.8V, R_L = 8\Omega,$   
 $f = 1kHz, LS$

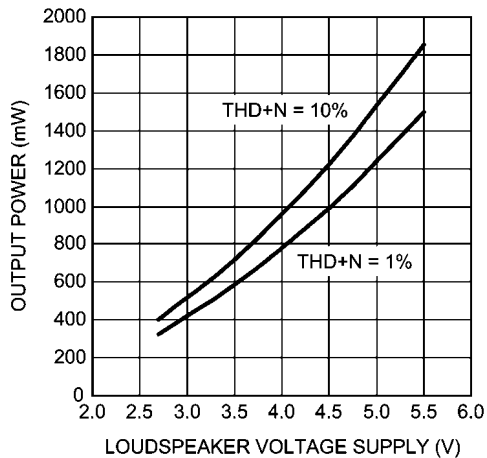

300015d8

**Output Power vs Supply Voltage**  
 $V_{DDHP} = 2.8V, R_L = 32\Omega,$   
 $f = 1kHz, HP$

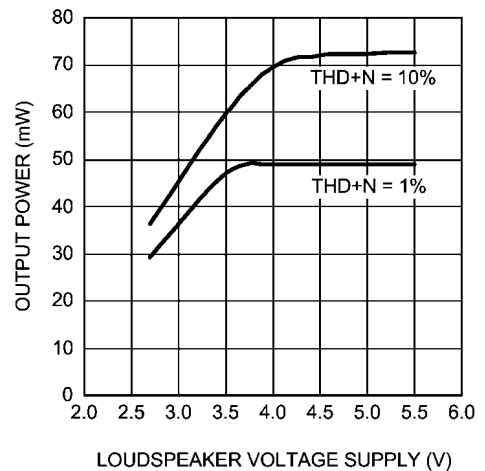

300015p8

**Power Dissipation vs Output Power**  
 $V_{DD} = 3.6V$ ,  $R_L = 8\Omega$ ,  
 $f = 1kHz$ , Mode 1

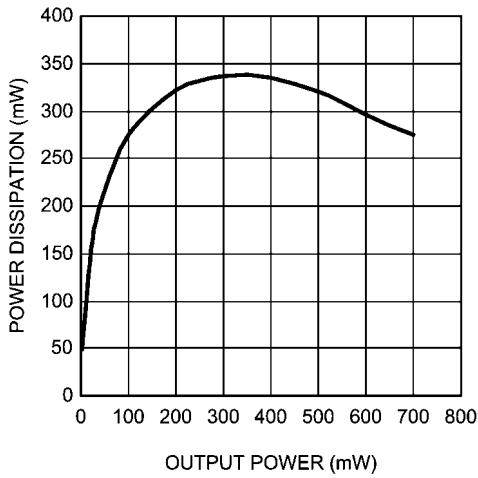

300015p5

**Power Dissipation vs Output Power**  
 $V_{DD} = 3V$ ,  $R_L = 8\Omega$ ,  
 $f = 1kHz$ , Mode 1

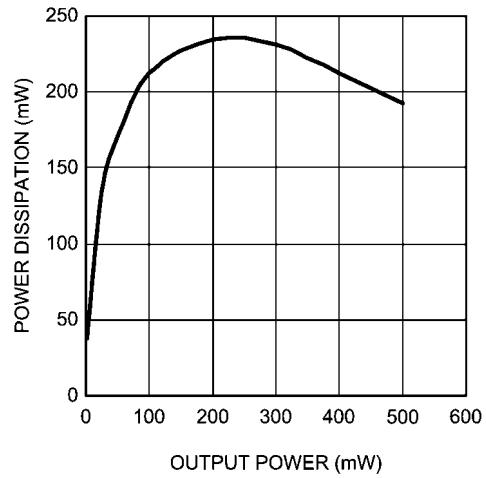

300015p6

**Power Dissipation vs Output Power**  
 $V_{DD} = 5V$ ,  $R_L = 8\Omega$ ,  
 $f = 1kHz$ , Mode 1

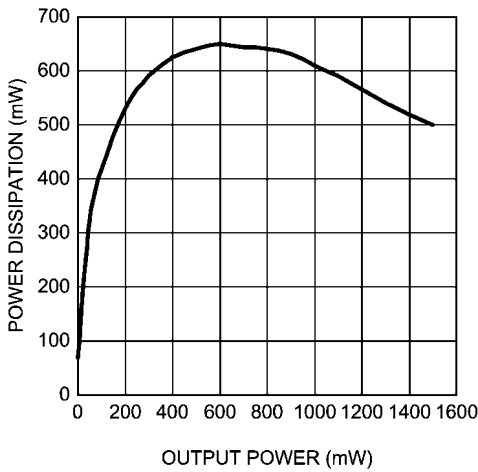

300015p7

**Supply Current vs  $V_{DDLS}$**   
 $V_{DDHP} = 2.8V$ , Mode 1, 3, 5, No Load

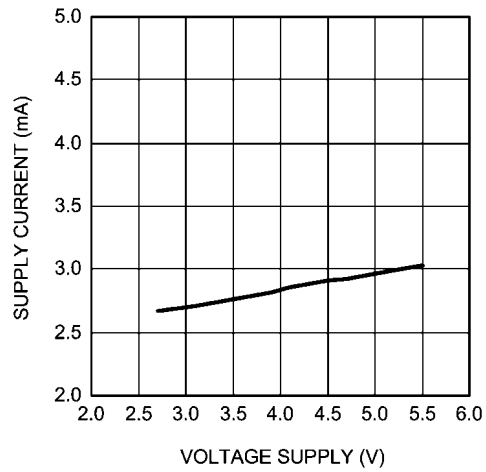

30001564

**Supply Current vs  $V_{DDLS}$**   
 $V_{DDHP} = 2.8V$ , Mode 2, 4, 6, No Load

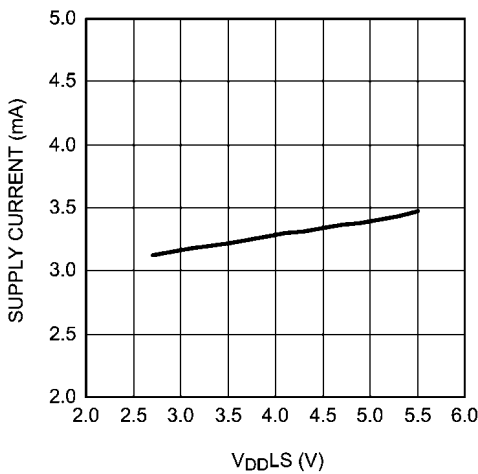

30001565

**Supply Current vs  $V_{DDLS}$**   
 $V_{DDHP} = 2.8V$ , Mode 7, 10, 14, No Load

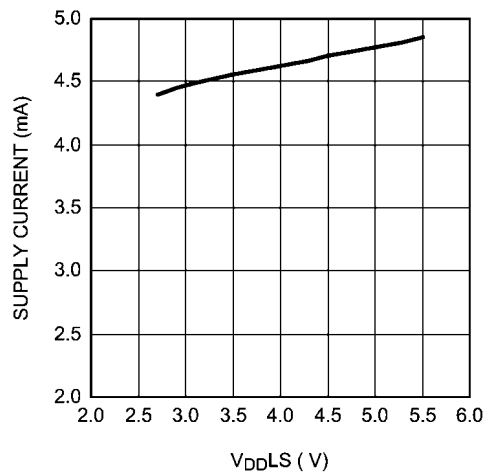

30001570

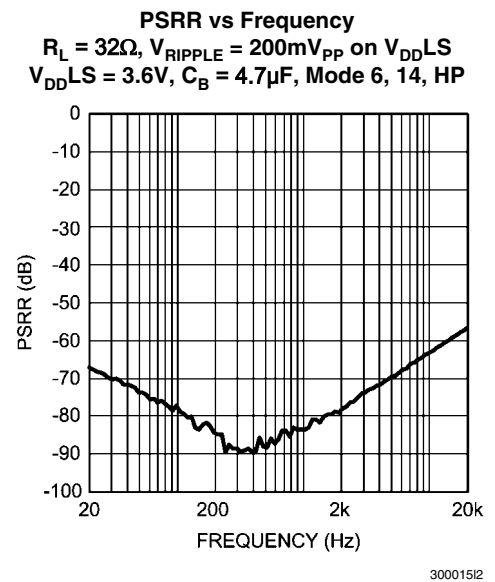
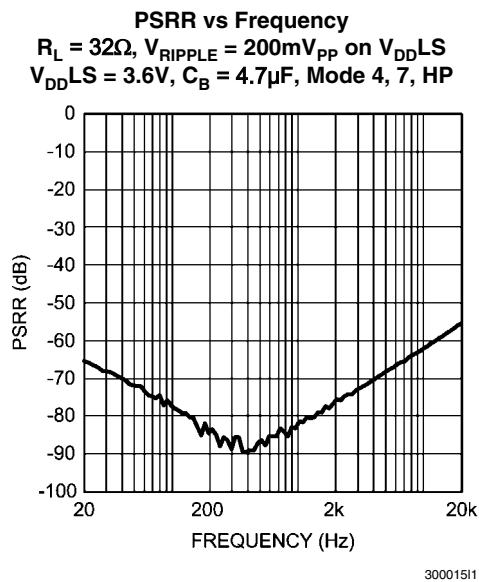
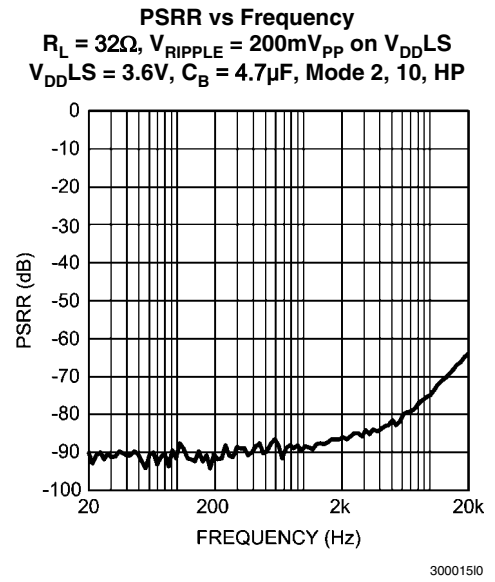
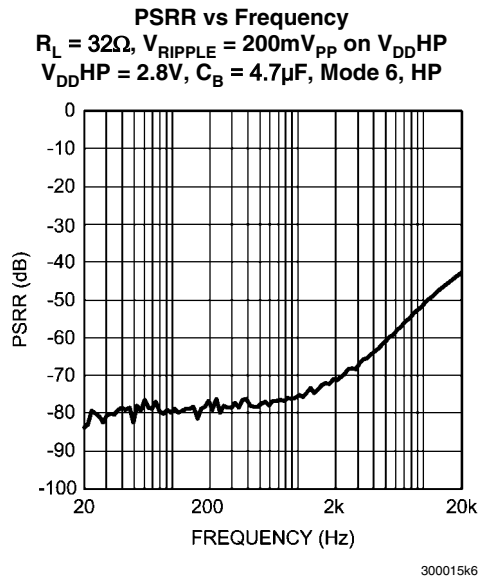
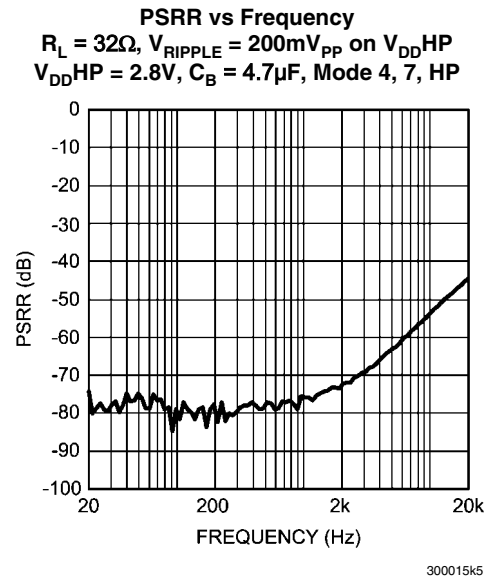
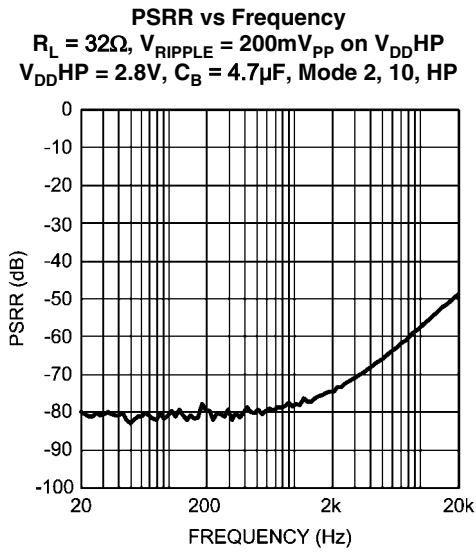

**PSRR vs Frequency**  
 $R_L = 8\Omega$ ,  $V_{RIPPLE} = 200mV_{PP}$  on  $V_{DDHP}$   
 $V_{DDHP} = 2.8V$ ,  $C_B = 4.7\mu F$ , Mode 7, 10, 14, LS+HP

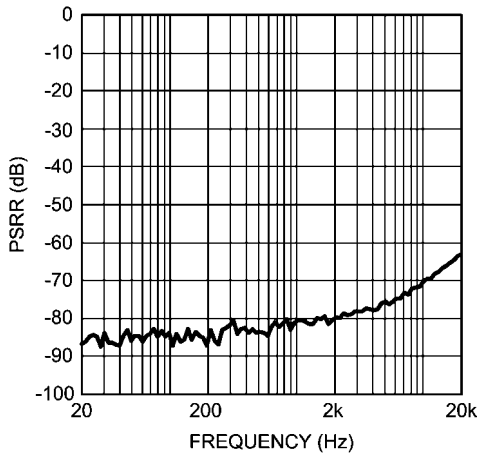

300015m3

**PSRR vs Frequency**  
 $R_L = 8\Omega$ ,  $V_{RIPPLE} = 200mV_{PP}$  on  $V_{DDL S}$   
 $V_{DDL S} = 3.6V$ ,  $C_B = 4.7\mu F$ , Mode 1, LS

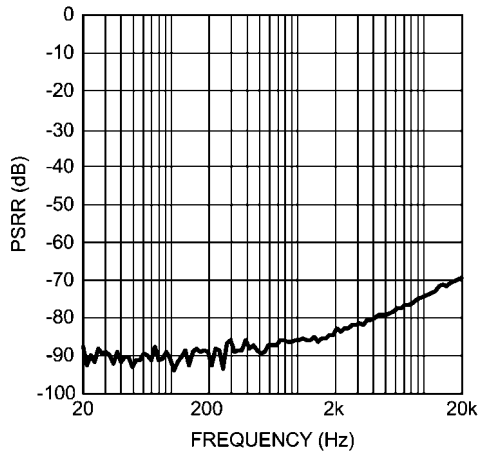

300015i6

**PSRR vs Frequency**  
 $R_L = 8\Omega$ ,  $V_{RIPPLE} = 200mV_{PP}$  on  $V_{DDL S}$   
 $V_{DDL S} = 3.6V$ ,  $C_B = 4.7\mu F$ , Mode 7, 10, 14, LS+HP

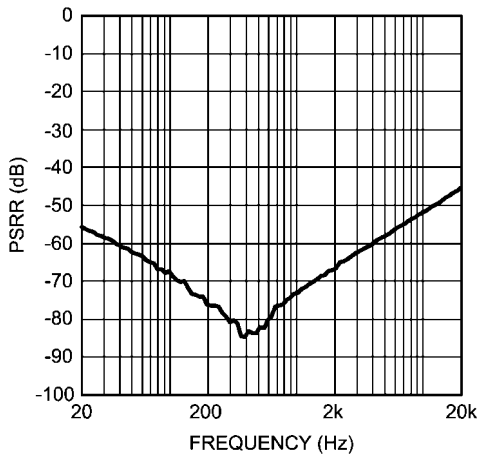

300015m0

**PSRR vs Frequency**  
 $R_L = 8\Omega$ ,  $V_{RIPPLE} = 200mV_{PP}$  on  $V_{DDL S}$   
 $V_{DDL S} = 3.6V$ ,  $C_B = 4.7\mu F$ , Mode 3, LS

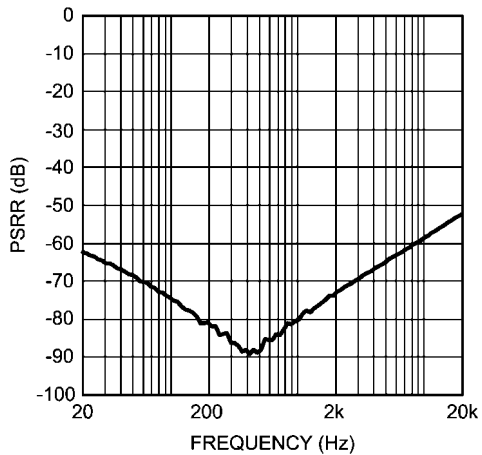

300015i7

**PSRR vs Frequency**  
 $R_L = 8\Omega$ ,  $V_{RIPPLE} = 200mV_{PP}$  on  $V_{DDL S}$   
 $V_{DDL S} = 3.6V$ ,  $C_B = 4.7\mu F$ , Mode 5, LS

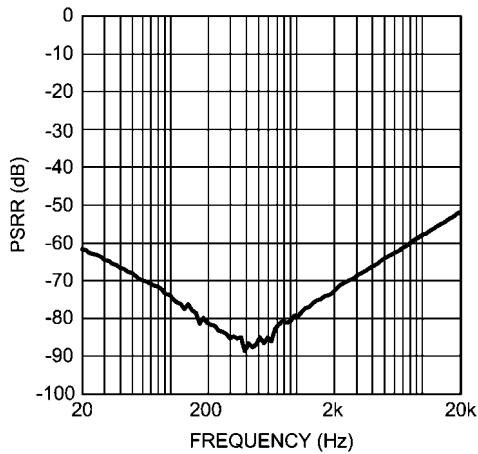

300015i8

**Crosstalk vs Frequency**  
 $P_O = 12mW$ ,  $f = 1kHz$ , Mode 4, HP

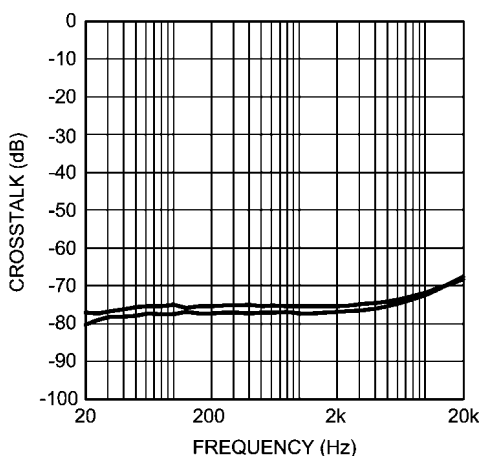

30001525

## LM49100 Control Tables

**TABLE 1. I<sup>2</sup>C Control Register Table**

The LM49100 is controlled through an I<sup>2</sup>C compatible interface. The I<sup>2</sup>C chip address is 0xF8 (ADR pin = 0) or 0xFAh (ADDR pin = 1).

	D7	D6	D5	D4	D3	D2	D1	D0
<b>Modes Control</b>	0	0	1	1	MC3	MC2	MC1	MC0
<b>HP Volume (Gain) Control</b>	0	1	INPUT_MUTE	0	0	HPR_SD	HPVC1	HPVC0
<b>Mono Volume Control</b>	1	0	0	MV4	MV3	MV2	MV1	MV0
<b>Left Volume (Gain) Control</b>	1	1	0	LV4	LV3	LV2	LV1	LV0
<b>Right Volume (Gain) Control</b>	1	1	1	RV4	RV3	RV2	RV1	RV0

**TABLE 2. Headphone Attenuation Control**

The following bits have added for extra headphone output attenuation:

Gain Select	HPVC1	HPVC0	Gain, dB
0	0	0	0
1	0	1	-12
2	1	0	-18
3	1	1	-24

**TABLE 3. Output Mode Selection**

Output Mode Number	MC3	MC2	MC1	MC0	Handsfree Mono Output	Right HP Output	Left HP Output
0	0	0	0	0	SD	SD	SD
1	0	0	0	1	$2 \times G_M \times M$	SD	SD
2	0	0	1	0	SD	$G_{HP} \times (G_M \times M)$	$G_{HP} \times (G_M \times M)$
3	0	0	1	1	$2 \times (G_L \times L + G_R \times R)$	SD	SD
4	0	1	0	0	SD	$G_{HP} \times (G_R \times R)$	$G_{HP} \times (G_L \times L)$
5	0	1	0	1	$2 \times (G_L \times L + G_R \times R + G_M \times M)$	SD	SD
6	0	1	1	0	SD	$G_{HP} \times (G_R \times R + G_M \times M)$	$G_{HP} \times (G_L \times L + G_M \times M)$
7	0	1	1	1	$2 \times (G_L \times L + G_R \times R)$	$G_{HP} \times (G_R \times R)$	$G_{HP} \times (G_L \times L)$
10	1	0	1	0	$2 \times (G_L \times L + G_R \times R)$	$G_{HP} \times (G_M \times M)$	$G_{HP} \times (G_M \times M)$
14	1	1	1	0	$2 \times (G_L \times L + G_R \times R)$	$G_{HP} \times (G_R \times R + G_M \times M)$	$G_{HP} \times (G_L \times L + G_M \times M)$

$G_L$  — Left channel gain  
 $G_R$  — Right channel gain  
 $G_M$  — Mono channel gain  
 $G_{HP}$  — Headphone Amplifier gain  
 $R$  — Right input signal  
 $L$  — Left input signal  
 $SD$  — Shutdown  
 $M$  — Mono input signal

TABLE 4. Mono/Stereo Left/Stereo Right Input Gain Control

Volume Step	MV4/LV4/RV4	MV3/LV3/RV3	MV2/LV2/RV2	MV1/LV1/RV1	MV0/LV0/RV0	R/L Gain, dB	MonoGain, dB
1	0	0	0	0	0	-54	-60
2	0	0	0	0	1	-47	-53
3	0	0	0	1	0	-40.5	-46.5
4	0	0	0	1	1	-34.5	-40.5
5	0	0	1	0	0	-30.0	-36
6	0	0	1	0	1	-27	-33
7	0	0	1	1	0	-24	-30
8	0	0	1	1	1	-21	-27
9	0	1	0	0	0	-18	-24
10	0	1	0	0	1	-15	-21
11	0	1	0	1	0	-13.5	-19.5
12	0	1	0	1	1	-12	-18
13	0	1	1	0	0	-10.5	-16.5
14	0	1	1	0	1	-9	-15
15	0	1	1	1	0	-7.5	-13.5
16	0	1	1	1	1	-6	-12
17	1	0	0	0	0	-4.5	-10.5
18	1	0	0	0	1	-3	-9
19	1	0	0	1	0	-1.5	-7.5
20	1	0	0	1	1	0	-6
21	1	0	1	0	0	1.5	-4.5
22	1	0	1	0	1	3	-3
23	1	0	1	1	0	4.5	-1.5
24	1	0	1	1	1	6	0
25	1	1	0	0	0	7.5	1.5
26	1	1	0	0	1	9	3
27	1	1	0	1	0	10.5	4.5
28	1	1	0	1	1	12	6
29	1	1	1	0	0	13.5	7.5
30	1	1	1	0	1	15	9
31	1	1	1	1	0	16.5	10.5
32	1	1	1	1	1	18	12

## Application Information

### MINIMIZING CLICK AND POP

To minimize the audible click and pop heard through a headphone, maximize the input signal through the corresponding volume (gain) control registers and adjust the output amplifier gain accordingly to achieve the user's desired signal gain. For example, setting the output of the headphone amplifier to -24dB and setting the input volume control gain to 24dB will reduce the output offset from 7mV (typical) to 2.2mV (typical). This will reduce the audible click and pop noise significantly while maintaining a 0dB signal gain.

### SIGNAL GROUND NOISE

The LM49100 has proprietary suppression circuitry, which provides an additional -50dB (typical) attenuation of the headphone ground noise and its incursion into the headphone. For optimum utilization of this feature the headphone jack ground should connect to the AGND (E3) bump.

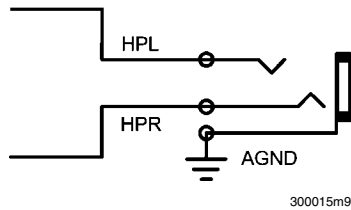

### I<sup>2</sup>C PIN DESCRIPTION

SDA: This is the serial data input pin.

SCL: This is the clock input pin.

ADDR: This is the address select input pin.

### I<sup>2</sup>C COMPATIBLE INTERFACE

The LM49100 uses a serial bus which conforms to the I<sup>2</sup>C protocol to control the chip's functions with two wires: clock (SCL) and data (SDA). The clock line is uni-directional. The data line is bi-directional (open-collector). The LM49100's I<sup>2</sup>C compatible interface supports standard (100kHz) and fast (400kHz) I<sup>2</sup>C modes. In this discussion, the master is the controlling microcontroller and the slave is the LM49100.

The I<sup>2</sup>C address for the LM49100 is determined using the ADDR pin. The LM49100's two possible I<sup>2</sup>C chip addresses

are of the form 111110X<sub>1</sub>0 (binary), where X<sub>1</sub> = 0, if ADDR pin is logic LOW; and X<sub>1</sub> = 1, if ADDR pin is logic HIGH. If the I<sup>2</sup>C interface is used to address a number of chips in a system, the LM49100's chip address can be changed to avoid any possible address conflicts.

The bus format for the I<sup>2</sup>C interface is shown in Figure 2. The bus format diagram is broken up into six major sections:

The "start" signal is generated by lowering the data signal while the clock signal is HIGH. The start signal will alert all devices attached to the I<sup>2</sup>C bus to check the incoming address against their own address.

The 8-bit chip address is sent next, most significant bit first. The data is latched in on the rising edge of the clock. Each address bit must be stable while the clock level is HIGH.

After the last bit of the address bit is sent, the master releases the data line HIGH (through a pull-up resistor). Then the master sends an acknowledge clock pulse. If the LM49100 has received the address correctly, then it holds the data line LOW during the acknowledge clock pulse. If the data line is not held LOW during the acknowledge clock pulse, then the master should abort the rest of the data transfer to the LM49100.

The 8 bits of data are sent next, most significant bit first. Each data bit should be valid while the clock level is stable HIGH.

After the data byte is sent, the master must check for another acknowledge to see if the LM49100 received the data.

If the master has more data bytes to send to the LM49100, then the master can repeat the previous two steps until all data bytes have been sent.

The "stop" signal ends the transfer. To signal "stop", the data signal goes HIGH while the clock signal is HIGH. The data line should be held HIGH when not in use.

### I<sup>2</sup>C INTERFACE POWER SUPPLY PIN (V<sub>DD</sub>I<sup>2</sup>C)

The LM49100's I<sup>2</sup>C interface is powered up through the V<sub>DD</sub>I<sup>2</sup>C pin. The LM49100's I<sup>2</sup>C interface operates at a voltage level set by the V<sub>DD</sub>I<sup>2</sup>C pin which can be set independent to that of the main power supply pin V<sub>DD</sub>. This is ideal whenever logic levels for the I<sup>2</sup>C interface are dictated by a microcontroller or microprocessor that is operating at a lower supply voltage than the main battery of a portable system.

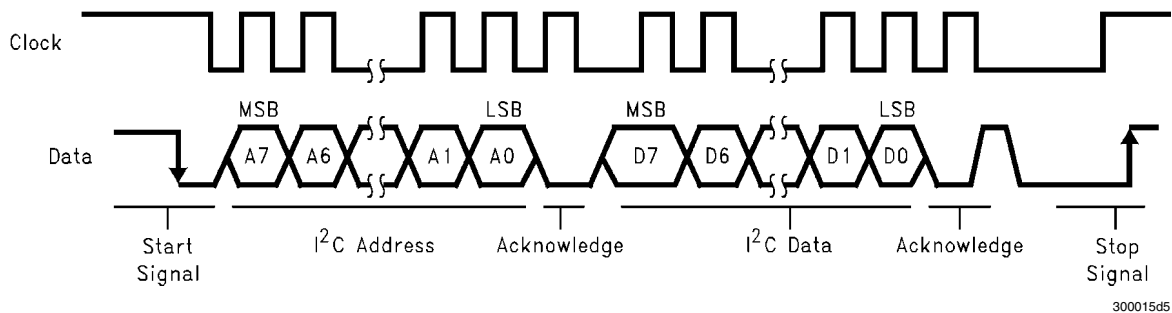
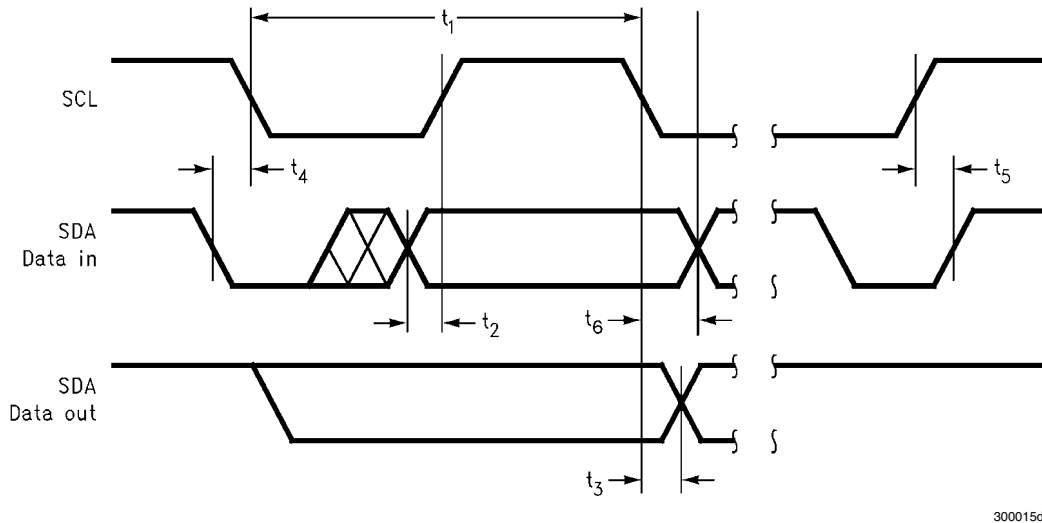

FIGURE 2. I<sup>2</sup>C Bus Format



FIGURE 3. I<sup>2</sup>C Timing Diagram

300015d6

### PCB LAYOUT AND SUPPLY REGULATION CONSIDERATIONS FOR DRIVING 8Ω LOAD

Power dissipated by a load is a function of the voltage swing across the load and the load's impedance. As load impedance decreases, load dissipation becomes increasingly dependent on the interconnect (PCB trace and wire) resistance between the amplifier output pins and the load's connections. Residual trace resistance causes a voltage drop, which results in power dissipated in the trace and not in the load as desired. For example, 0.1Ω trace resistance reduces the output power dissipated by an 8Ω load from 158.3mW to 156.4mW. The problem of decreased load dissipation is exacerbated as load impedance decreases. Therefore, to maintain the highest load dissipation and widest output voltage swing, PCB traces that connect the output pins to a load must be as wide as possible.

Poor power supply regulation adversely affects maximum output power. A poorly regulated supply's output voltage decreases with increasing load current. Reduced supply voltage causes decreased headroom, output signal clipping, and reduced output power. Even with tightly regulated supplies, trace resistance creates the same effects as poor supply regulation. Therefore, making the power supply traces as wide as possible helps maintain full output voltage swing.

### BRIDGE CONFIGURATION EXPLANATION

The LM49100 drives a load, such as a loudspeaker, connected between outputs, LS+ and LS-.

This results in both amplifiers producing signals identical in magnitude, but 180° out of phase. Taking advantage of this phase difference, a load is placed between LS- and LS+ and driven differentially (commonly referred to as "bridge mode").

Bridge mode amplifiers are different from single-ended amplifiers that drive loads connected between a single amplifier's output and ground. For a given supply voltage, bridge mode has a distinct advantage over the single-ended configuration: its differential output doubles the voltage swing across the load. Theoretically, this produces four times the output power when compared to a single-ended amplifier under the same conditions. This increase in attainable output power assumes that the amplifier is not current limited and that the output signal is not clipped.

Another advantage of the differential bridge output is no net DC voltage across the load. This is accomplished by biasing LS- and LS+ outputs at half-supply. This eliminates the coupling capacitor that single supply, single-ended amplifiers require. Eliminating an output coupling capacitor in a typical single-ended configuration forces a single-supply amplifier's half-supply bias voltage across the load. This increases internal IC power dissipation and may permanently damage loads such as loudspeakers.

### POWER DISSIPATION

Power dissipation is a major concern when designing a successful single-ended or bridged amplifier.

A direct consequence of the increased power delivered to the load by a bridge amplifier is higher internal power dissipation. The LM49100 has a pair of bridged-tied amplifiers driving a handsfree loudspeaker, LS. The maximum internal power dissipation operating in the bridge mode is twice that of a single-ended amplifier. From Equation (1), assuming a 5V power supply and an 8Ω load, the maximum MONO power dissipation is 634mW.

$$P_{\text{DMAX-LS}} = 4(V_{\text{DD}})^2 / (2\pi^2 R_L): \text{Bridge Mode} \quad (1)$$

The LM49100 also has a pair of single-ended amplifiers driving stereo headphones, HPR and HPL. The maximum internal power dissipation for HPR and HPL is given by equation (2). Assuming a 2.8V power supply and a 32Ω load, the maximum power dissipation for L<sub>OUT</sub> and R<sub>OUT</sub> is 49mW, or 99mW total.

$$P_{\text{DMAX-HPL}} = 4(V_{\text{DD}}\text{HP})^2 / (2\pi^2 R_L): \text{Single-ended Mode} \quad (2)$$

The maximum internal power dissipation of the LM49100 occurs when all three amplifiers pairs are simultaneously on; and is given by Equation (3).

$$P_{\text{DMAX-TOTAL}} = P_{\text{DMAX-LS}} + P_{\text{DMAX-HPL}} + P_{\text{DMAX-HPR}} \quad (3)$$

The maximum power dissipation point given by Equation (3) must not exceed the power dissipation given by Equation (4):

$$P_{\text{DMAX}} = (T_{\text{JMAX}} - T_{\text{A}}) / \theta_{\text{JA}} \quad (4)$$

The LM49100's  $T_{\text{JMAX}} = 150^{\circ}\text{C}$ . In the GR package, the LM49100's  $\theta_{\text{JA}}$  is  $50.2^{\circ}\text{C}/\text{W}$ . At any given ambient temperature  $T_{\text{A}}$ , use Equation (4) to find the maximum internal power dissipation supported by the IC packaging. Rearranging Equation (4) and substituting  $P_{\text{DMAX-TOTAL}}$  for  $P_{\text{DMAX}}$  results in Equation (5). This equation gives the maximum ambient temperature that still allows maximum stereo power dissipation without violating the LM49100's maximum junction temperature.

$$T_{\text{A}} = T_{\text{JMAX}} - P_{\text{DMAX-TOTAL}} \theta_{\text{JA}} \quad (5)$$

For a typical application with a 5V power supply and an  $8\Omega$  load, the maximum ambient temperature that allows maximum mono power dissipation without exceeding the maximum junction temperature is approximately  $114^{\circ}\text{C}$  for the GR package.

$$T_{\text{JMAX}} = P_{\text{DMAX-TOTAL}} \theta_{\text{JA}} + T_{\text{A}} \quad (6)$$

Equation (6) gives the maximum junction temperature  $T_{\text{JMAX}}$ . If the result violates the LM49100's  $150^{\circ}\text{C}$ , reduce the maximum junction temperature by reducing the power supply voltage or increasing the load resistance. Further allowance should be made for increased ambient temperatures.

The above examples assume that a device is a surface mount part operating around the maximum power dissipation point. Since internal power dissipation is a function of output power, higher ambient temperatures are allowed as output power or duty cycle decreases. If the result of Equation (3) is greater than that of Equation (4), then decrease the supply voltage, increase the load impedance, or reduce the ambient temperature. If these measures are insufficient, a heat sink can be added to reduce  $\theta_{\text{JA}}$ . The heat sink can be created using additional copper area around the package, with connections to the ground pin(s), supply pin and amplifier output pins.

#### POWER SUPPLY BYPASSING

As with any power amplifier, proper supply bypassing is critical for low noise performance and high power supply rejection. Applications that employ a 5V regulator typically use a

$1\mu\text{F}$  in parallel with a  $0.1\mu\text{F}$  filter capacitors to stabilize the regulator's output, reduce noise on the supply line, and improve the supply's transient response. However, their presence does not eliminate the need for a local  $4.7\mu\text{F}$  tantalum bypass capacitor and a parallel  $0.1\mu\text{F}$  ceramic capacitor connected between the LM49100's supply pin and ground. Keep the length of leads and traces that connect capacitors between the LM49100's power supply pin and ground as short as possible.

#### SELECTING EXTERNAL COMPONENTS

##### Input Capacitor Value Selection

Amplifying the lowest audio frequencies requires high value input coupling capacitor ( $C_{\text{IN}}$  in Figure 1). A high value capacitor can be expensive and may compromise space efficiency in portable designs. In many cases, however, the loudspeakers used in portable systems, whether internal or external, have little ability to reproduce signals below 150Hz. Applications using loudspeakers and headphones with this limited frequency response reap little improvement by using large input capacitor.

The internal input resistor ( $R_{\text{i}}$ ), typical  $12.5\text{k}\Omega$ , and the input capacitor ( $C_{\text{IN}}$ ) produce a high pass filter cutoff frequency that is found using Equation (7).

$$f_{\text{c}} = 1 / (2\pi R_{\text{i}} C_{\text{IN}}) \quad (7)$$

##### Bypass Capacitor Value Selection

Besides minimizing the input capacitor size, careful consideration should be paid to value of  $C_{\text{B}}$ , the capacitor connected to the BYPASS pin. Since  $C_{\text{B}}$  determines how fast the LM49100 settles to quiescent operation, its value is critical when minimizing turn-on pops. Choosing  $C_{\text{B}}$  equal to  $2.2\mu\text{F}$  along with a small value of  $C_{\text{i}}$  (in the range of  $0.1\mu\text{F}$  to  $0.33\mu\text{F}$ ), produces a click-less and pop-less shutdown function. As discussed above, choosing  $C_{\text{IN}}$  no larger than necessary for the desired bandwidth helps minimize clicks and pops.  $C_{\text{B}}$ 's value should be in the range of 4 to 5 times the value of  $C_{\text{IN}}$ . This ensures that output transients are eliminated when power is first applied or the LM49100 resumes operation after shutdown.

# Demo Board Schematic

LM49100

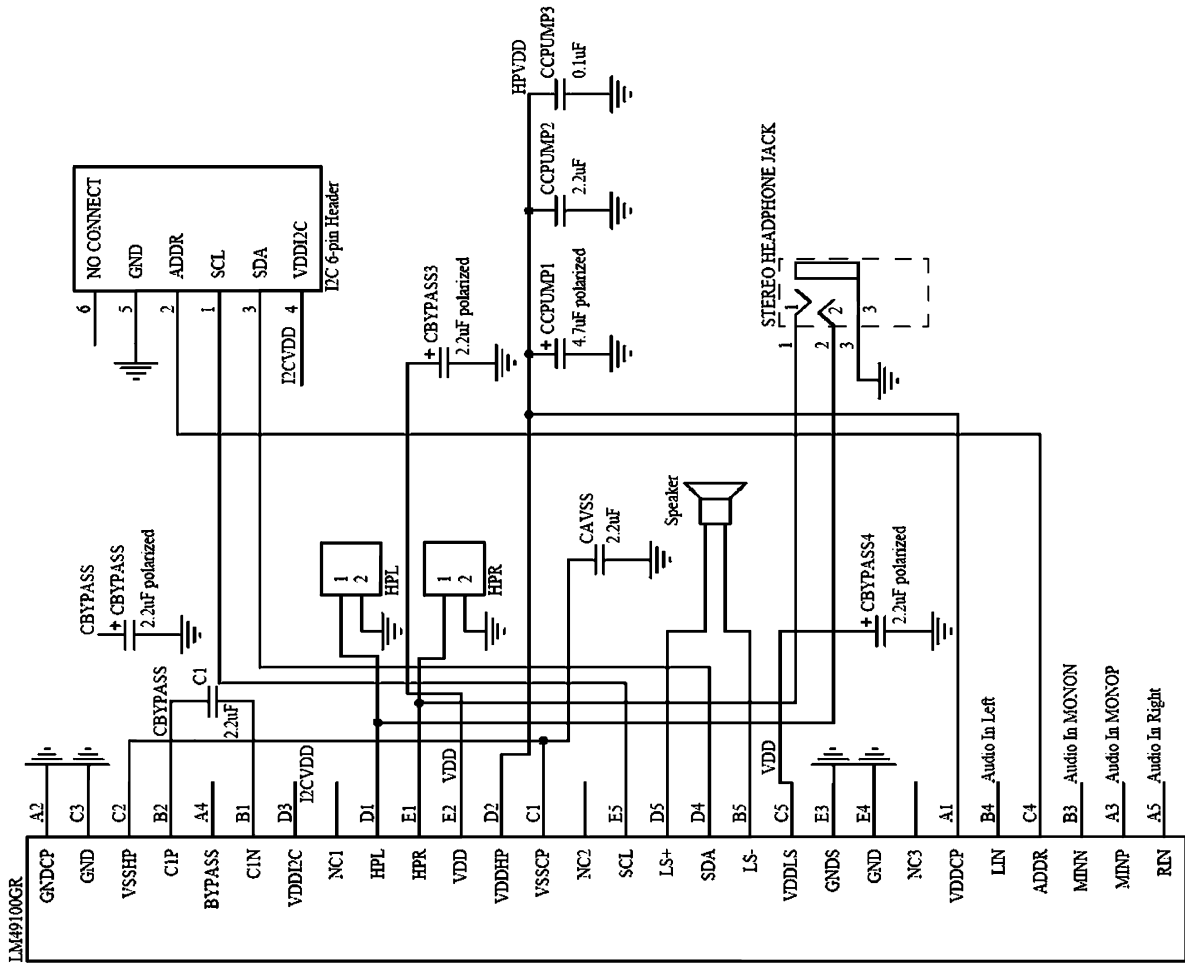

300015q3

Demo Board Schematic

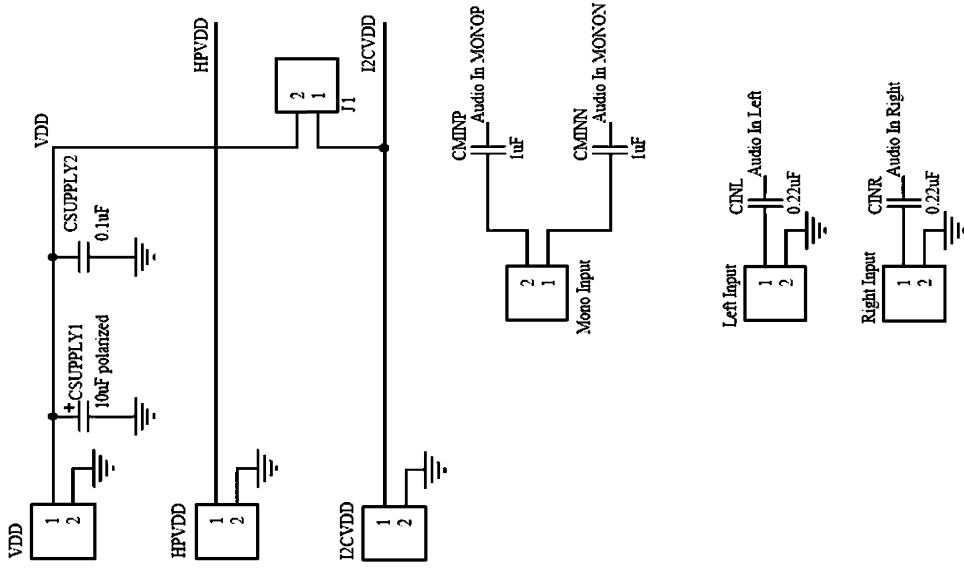

# Demonstration Board Layout

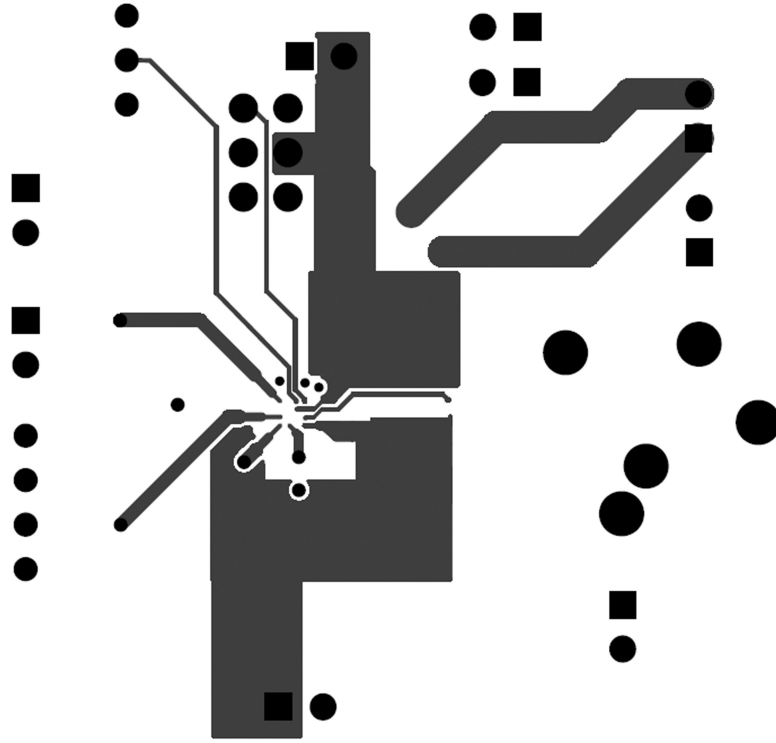

Signal 1 Layer

30001510

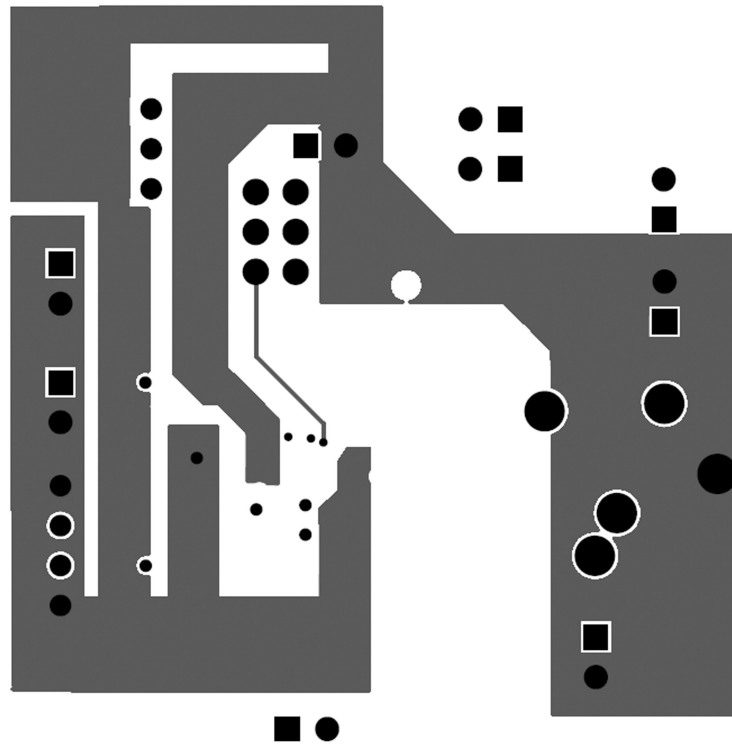

Signal 2 Layer

30001511

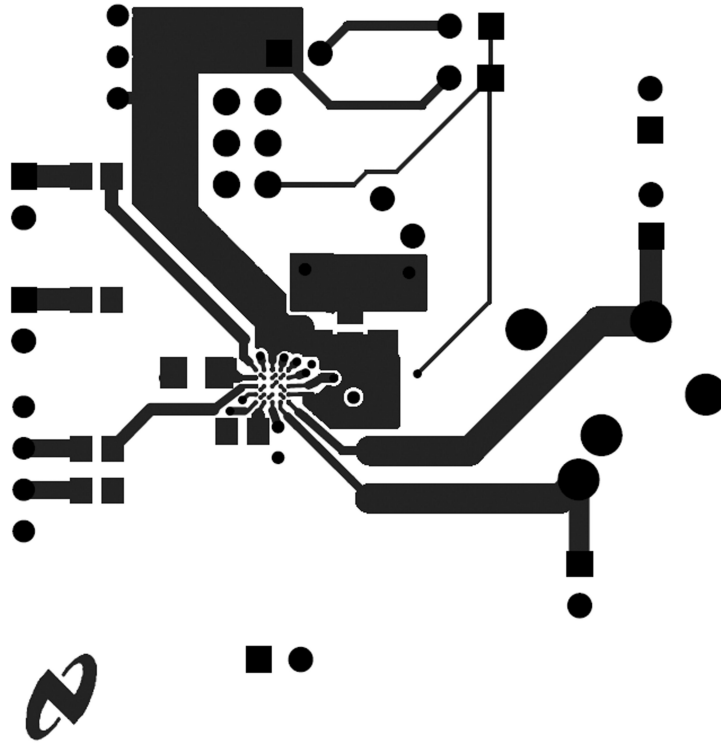

Top Layer

30001512

J1 = OPEN, Power applied to VDD and I2CUDD  
 J1 = SHORT, VDD = VDDI2C

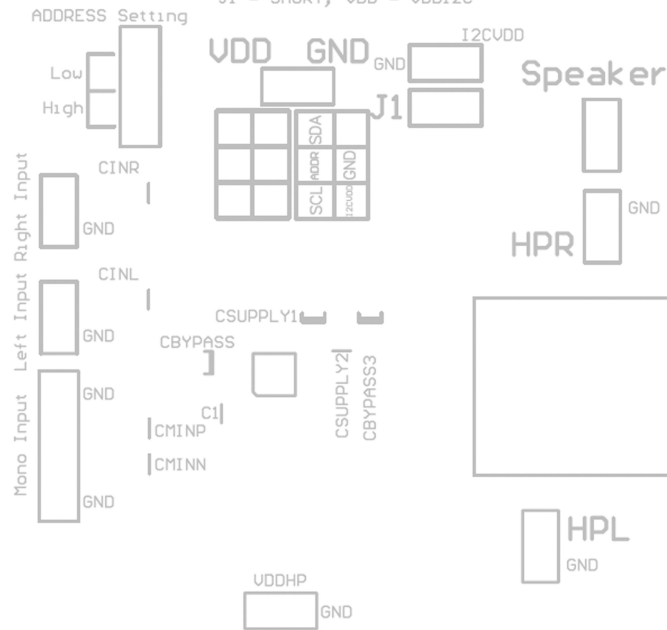

National Semiconductor  
 LM49100GR Audio Subsystem

Top Overlay

30001513

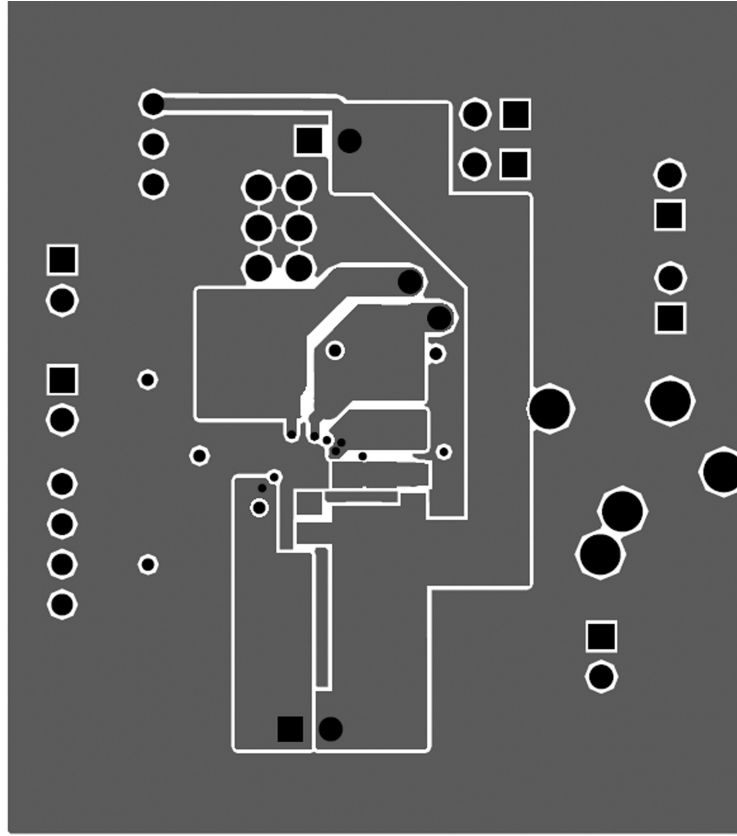

Bottom Layer

300015e8



22101302R-001 Rev. A

Bottom Overlay

300015e9

## Revision History

Rev	Date	Description
1.0	06/21/07	Initial release.
1.1	06/28/07	Changed the mktg outline from TLA25XXX to GRA25A.
1.2	08/09/07	Replaced some curves.
1.3	08/13/07	Changed the $f = 1\text{kHz}$ into $f = 217\text{Hz}$ (PSRR) in the Electrical Characteristics table.
1.4	08/14/07	Edited Table 1.
1.5	09/18/07	Edited the schematic diagram.

**Physical Dimensions** inches (millimeters) unless otherwise noted

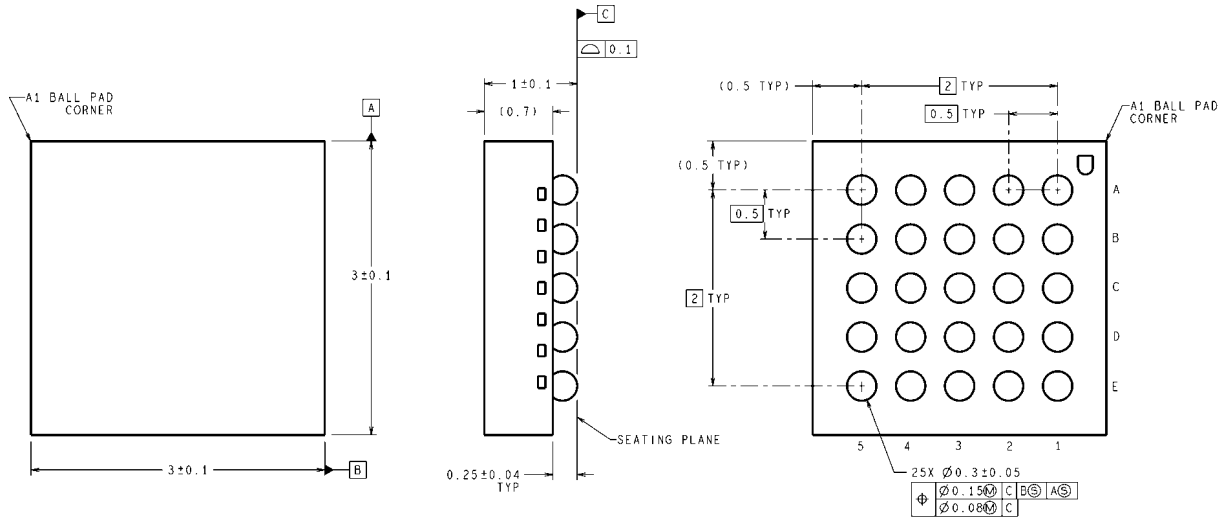

DIMENSIONS ARE IN MILLIMETERS  
DIMENSIONS IN ( ) FOR REFERENCE ONLY

**Dimensions:  $X_1 = X_2 = 3 \text{ mm}$ ,  $X_3 = 1 \text{ mm}$**   
**GR Package**  
**Order Number LM49100GR**  
**See NS Package Number GRA25A**

GRA25A (Rev A)



# Notes

LM49100

## Notes

THE CONTENTS OF THIS DOCUMENT ARE PROVIDED IN CONNECTION WITH NATIONAL SEMICONDUCTOR CORPORATION ("NATIONAL") PRODUCTS. NATIONAL MAKES NO REPRESENTATIONS OR WARRANTIES WITH RESPECT TO THE ACCURACY OR COMPLETENESS OF THE CONTENTS OF THIS PUBLICATION AND RESERVES THE RIGHT TO MAKE CHANGES TO SPECIFICATIONS AND PRODUCT DESCRIPTIONS AT ANY TIME WITHOUT NOTICE. NO LICENSE, WHETHER EXPRESS, IMPLIED, ARISING BY ESTOPPEL OR OTHERWISE, TO ANY INTELLECTUAL PROPERTY RIGHTS IS GRANTED BY THIS DOCUMENT.

TESTING AND OTHER QUALITY CONTROLS ARE USED TO THE EXTENT NATIONAL DEEMS NECESSARY TO SUPPORT NATIONAL'S PRODUCT WARRANTY. EXCEPT WHERE MANDATED BY GOVERNMENT REQUIREMENTS, TESTING OF ALL PARAMETERS OF EACH PRODUCT IS NOT NECESSARILY PERFORMED. NATIONAL ASSUMES NO LIABILITY FOR APPLICATIONS ASSISTANCE OR BUYER PRODUCT DESIGN. BUYERS ARE RESPONSIBLE FOR THEIR PRODUCTS AND APPLICATIONS USING NATIONAL COMPONENTS. PRIOR TO USING OR DISTRIBUTING ANY PRODUCTS THAT INCLUDE NATIONAL COMPONENTS, BUYERS SHOULD PROVIDE ADEQUATE DESIGN, TESTING AND OPERATING SAFEGUARDS.

EXCEPT AS PROVIDED IN NATIONAL'S TERMS AND CONDITIONS OF SALE FOR SUCH PRODUCTS, NATIONAL ASSUMES NO LIABILITY WHATSOEVER, AND NATIONAL DISCLAIMS ANY EXPRESS OR IMPLIED WARRANTY RELATING TO THE SALE AND/OR USE OF NATIONAL PRODUCTS INCLUDING LIABILITY OR WARRANTIES RELATING TO FITNESS FOR A PARTICULAR PURPOSE, MERCHANTABILITY, OR INFRINGEMENT OF ANY PATENT, COPYRIGHT OR OTHER INTELLECTUAL PROPERTY RIGHT.

### LIFE SUPPORT POLICY

**NATIONAL'S PRODUCTS ARE NOT AUTHORIZED FOR USE AS CRITICAL COMPONENTS IN LIFE SUPPORT DEVICES OR SYSTEMS WITHOUT THE EXPRESS PRIOR WRITTEN APPROVAL OF THE CHIEF EXECUTIVE OFFICER AND GENERAL COUNSEL OF NATIONAL SEMICONDUCTOR CORPORATION.** As used herein:

Life support devices or systems are devices which (a) are intended for surgical implant into the body, or (b) support or sustain life and whose failure to perform when properly used in accordance with instructions for use provided in the labeling can be reasonably expected to result in a significant injury to the user. A critical component is any component in a life support device or system whose failure to perform can be reasonably expected to cause the failure of the life support device or system or to affect its safety or effectiveness.

National Semiconductor and the National Semiconductor logo are registered trademarks of National Semiconductor Corporation. All other brand or product names may be trademarks or registered trademarks of their respective holders.

Copyright© 2007 National Semiconductor Corporation

For the most current product information visit us at [www.national.com](http://www.national.com)



**National Semiconductor  
Americas Customer  
Support Center**  
Email:  
[new.feedback@nsc.com](mailto:new.feedback@nsc.com)  
Tel: 1-800-272-9959

**National Semiconductor Europe  
Customer Support Center**  
Fax: +49 (0) 180-530-85-86  
Email: [europe.support@nsc.com](mailto:europe.support@nsc.com)  
Deutsch Tel: +49 (0) 69 9508 6208  
English Tel: +49 (0) 870 24 0 2171  
Français Tel: +33 (0) 1 41 91 8790

**National Semiconductor Asia  
Pacific Customer Support Center**  
Email: [ap.support@nsc.com](mailto:ap.support@nsc.com)

**National Semiconductor Japan  
Customer Support Center**  
Fax: 81-3-5639-7507  
Email: [jpn.feedback@nsc.com](mailto:jpn.feedback@nsc.com)  
Tel: 81-3-5639-7560