

Reflexlichtschranke
Reflective Interrupter
Lead (Pb) Free Product - RoHS Compliant

SFH 9202

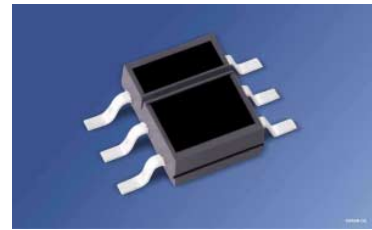

Wesentliche Merkmale

- Optimaler Arbeitsabstand 1 mm bis 5 mm
- IR-GaAs-Lumineszenzdiode in Kombination mit einem Si-NPN-Fototransistor
- Tageslichtsperrfilter
- Geringe Sättigungsspannung
- Sender und Empfänger galvanisch getrennt
- Vorbehandlung nach JEDEC Level 4

Anwendungen

- Positionsmelder
- Endabschalter
- Drehzahlüberwachung
- Bewegungssensor

Features

- Optimal operating distance 1 mm to 5 mm
- IR-GaAs-emitter in combination with a Silicon NPN phototransistor
- Daylight cut-off filter
- Low saturation voltage
- Emitter and detector electrically isolated
- Preconditioning acc. to JEDEC Level 4

Applications

- Position reporting
- End position switch
- Speed monitoring
- Motion transmitter

Typ Type	Bestellnummer Ordering Code	I_{CE} [mA] ($I_F = 10$ mA, $V_{CE} = 5$ V, $d = 1$ mm)
SFH 9202	Q65110A2712	0.063 ... 0.8
SFH 9202-2/3	Q65110A2705	0.063 ... 0.2
SFH 9202-3/4	Q65110A2710	0.10 ... 0.32
SFH 9202-4/5	Q65110A2709	0.16 ... 0.50
SFH 9202-5/6	Q65110A2711	0.25 ... 0.80

Grenzwerte
Maximum Ratings

Bezeichnung Parameter	Symbol Symbol	Wert Value	Einheit Unit
--------------------------	------------------	---------------	-----------------

Sender (GaAs-Diode)**Emitter** (GaAs diode)

Sperrspannung Reverse voltage	V_R	5	V
Vorwärtsgleichstrom Forward current	I_F	50	mA
Verlustleistung Power dissipation	P_{tot}	80	mW

Empfänger (Si-Fototransistor)**Detector** (silicon phototransistor)

Dauer-Kollektor-Emitter-Sperrspannung Continuous collector-emitter voltage	V_{CE}	16	V
Kollektor-Emitter-Sperrspannung, ($t \leq 1$ min) Collector-emitter voltage, ($t \leq 1$ min)	V_{CE}	30	
Emitter-Kollektor-Sperrspannung Emitter-collector voltage	V_{EC}	7	
Kollektorstrom Collector current	I_C	10	mA
Verlustleistung Total power dissipation	P_{tot}	100	mW

Reflexlichtschranke**Light Reflection Switch**

Lagertemperatur Storage temperature range	T_{stg}	- 40 ... + 100	°C
Umgebungstemperatur Ambient temperature range	T_A	- 40 ... + 100	
Verlustleistung Power dissipation	P_{tot}	150	mW
Elektrostatistische Entladung Electrostatic discharge	ESD	2	KV
Umweltbedingungen / Environment conditions	3 K3 acc. to EN 60721-3-3 (IEC 721-3-3)		

Kennwerte ($T_A = 25\text{ °C}$)

Characteristics

Bezeichnung Parameter	Symbol Symbol	Wert Value	Einheit Unit
--------------------------	------------------	---------------	-----------------

Sender (GaAs-Diode)**Emitter** (GaAs diode)

Durchlaßspannung Forward voltage $I_F = 50\text{ mA}$	V_F	1.25 (≤ 1.65)	V
Sperrstrom Reverse current $V_R = 5\text{ V}$	I_R	0.01 (≤ 1)	μA
Kapazität Capacitance $V_R = 0\text{ V}, f = 1\text{ MHz}$	C_O	25	pF
Wärmewiderstand ¹⁾ Thermal resistance ¹⁾	R_{thJA}	270	K/W

Empfänger (Si-Fototransistor)**Detector** (silicon phototransistor)

Kapazität Capacitance $V_{CE} = 5\text{ V}, f = 1\text{ MHz}$	C_{CE}	4	pF
Kollektor-Emitter-Reststrom Collector-emitter leakage current $V_{CE} = 20\text{ V}$	I_{CEO}	1 (≤ 50)	nA
Fotostrom (Fremdlichtempfindlichkeit) Photocurrent (outside light density) $V_{CE} = 5\text{ V}, E_v = 1000\text{ Lx}$	I_P	1	mA
Wärmewiderstand ¹⁾ Thermal resistance ¹⁾	R_{thJA}	270	K/W

Kennwerte ($T_A = 25\text{ °C}$)
Characteristics (cont'd)

Bezeichnung Parameter	Symbol Symbol	Wert Value	Einheit Unit
--------------------------	------------------	---------------	-----------------

Reflexlichtschranke
Light Reflection Switch

Kollektor-Emitterstrom Collector-emitter current Kodak neutral white test card, 90% Reflexion $I_F = 10\text{ mA}$; $V_{CE} = 5\text{ V}$; $d = 1\text{ mm}$	$I_{CE\text{ min.}}$ $I_{CE\text{ max}}$	63 800	μA μA
Kollektor-Emitter-Sättigungsspannung Collector-emitter saturation voltage Kodak neutral white test card, 90% Reflexion $I_F = 10\text{ mA}$; $d = 1\text{ mm}$; $I_C = 20\text{ }\mu\text{A}$	$V_{CE\text{ sat}}$	0.15 (≤ 0.6)	V

- 1) Montage auf PC-Board mit $> 5\text{ mm}^2$ Padgröße
 1) Mounting on pcb with $> 5\text{ mm}^2$ pad size

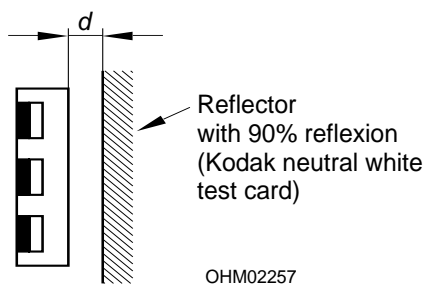

Schaltzeiten ($T_A = 25\text{ °C}$, $V_{CC} = 5\text{ V}$, $I_C = 100\text{ }\mu\text{A}^1$), $R_L = 1\text{ k}\Omega$)
Switching Times

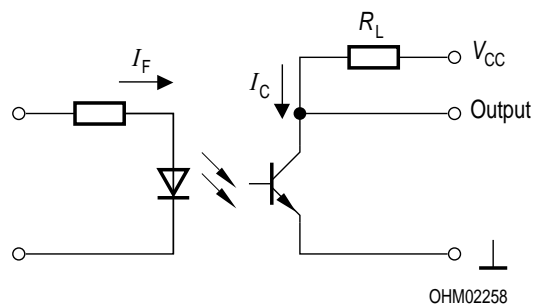

Bezeichnung Parameter	Symbol Symbol	Wert Value	Einheit Unit
Einschaltzeit Turn-on time	t_{ein} t_{on}	40	μs
Anstiegszeit Rise time	t_r	30	μs
Ausschaltzeit Turn-off time	t_{aus} t_{off}	45	μs
Abfallzeit Fall time	t_f	40	μs

¹⁾ I_C eingestellt über den Durchlaßstrom der Sendediode, den Reflexionsgrad und den Abstand des Reflektors vom Bauteil (d)

¹⁾ I_C as a function of the forward current of the emitting diode, the degree of reflection and the distance between reflector and component (d)

Collector Current $\frac{I_C}{I_{Cmax}} = f(d)$

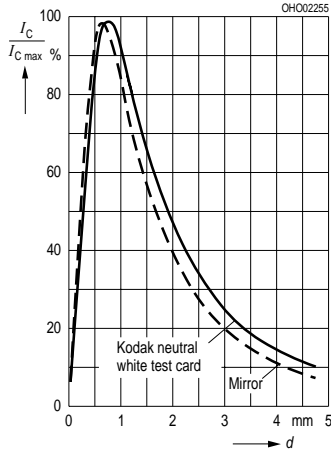

Permissible Power Dissipation for Diode and Transistor $P_{tot} = f(T_A)$

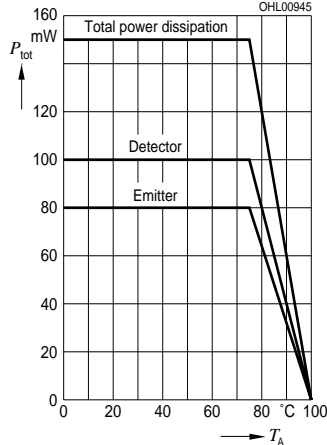

Switching Characteristics $t = f(R_L)$
 $T_A = 25^\circ\text{C}, I_F = 10\text{ mA}$

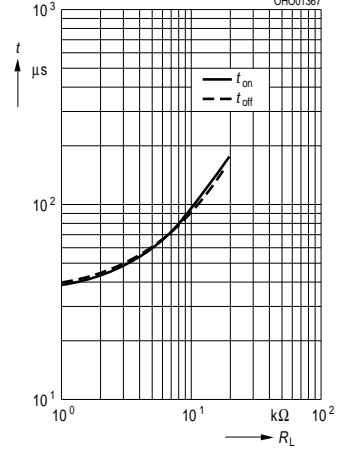

Max. Permissible Forward Current $I_F = f(T_A)$

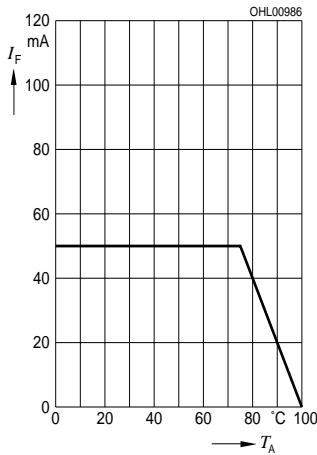

Transistor Capacitance (typ.) $C_{CE} = f(V_{CE}), T_A = 25^\circ\text{C}, f = 1\text{ MHz}$

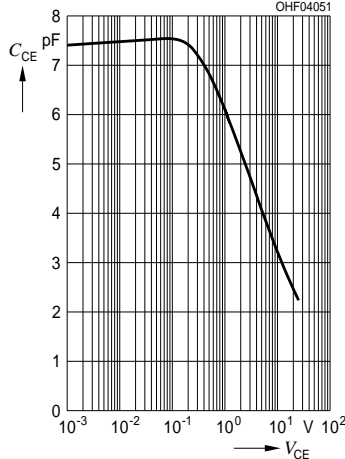

Collector Current $I_C = f(I_F)$, spacing d to reflector = 1 mm, 90% reflection

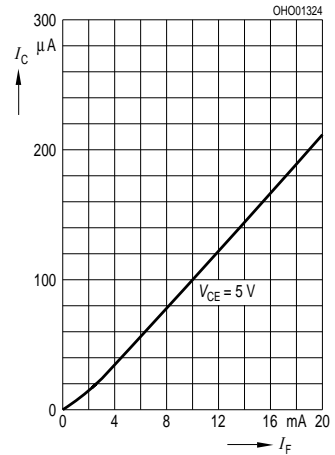

Forward Voltage (typ.) of the Diode $V_F = f(T)$

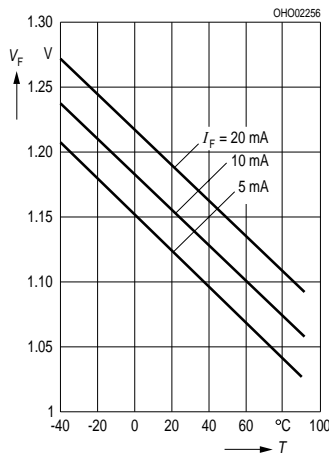

Relative Spectral Emission of Emitter (GaAs) $I_{rel} = f(\lambda)$ and Detector (Si) $S_{rel} = f(\lambda)$

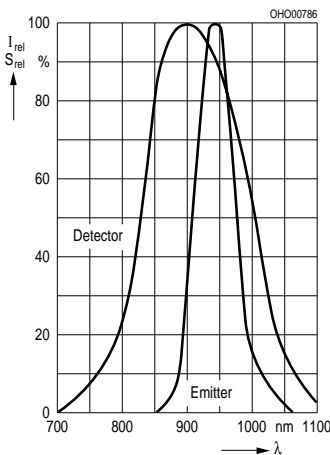

Output Characteristics (typ.) $I_C = f(V_{CE})$, spacing d to reflector = 1 mm, 90% reflection, $T_A = 25^\circ\text{C}$

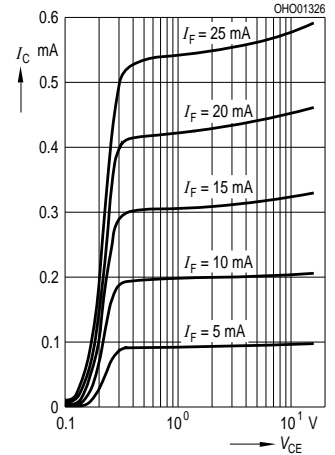

Perm. Pulse Handling Capability
 $I_F = f(t_p)$, Duty cycle $D =$ parameter,
 $T_A = 25\text{ }^\circ\text{C}$

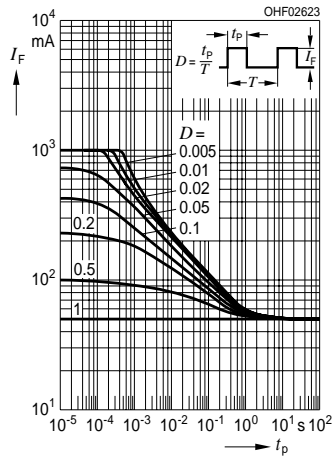

Perm. Pulse Handling Capability
 $I_F = f(t_p)$, Duty cycle $D =$ parameter,
 $T_A = 85\text{ }^\circ\text{C}$

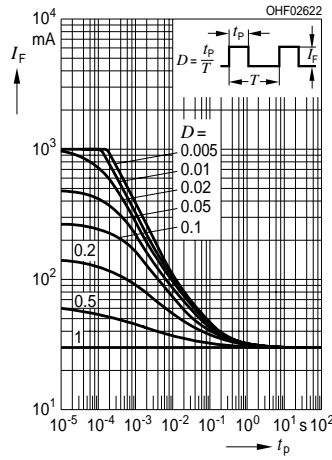

Maßzeichnung
Package Outlines

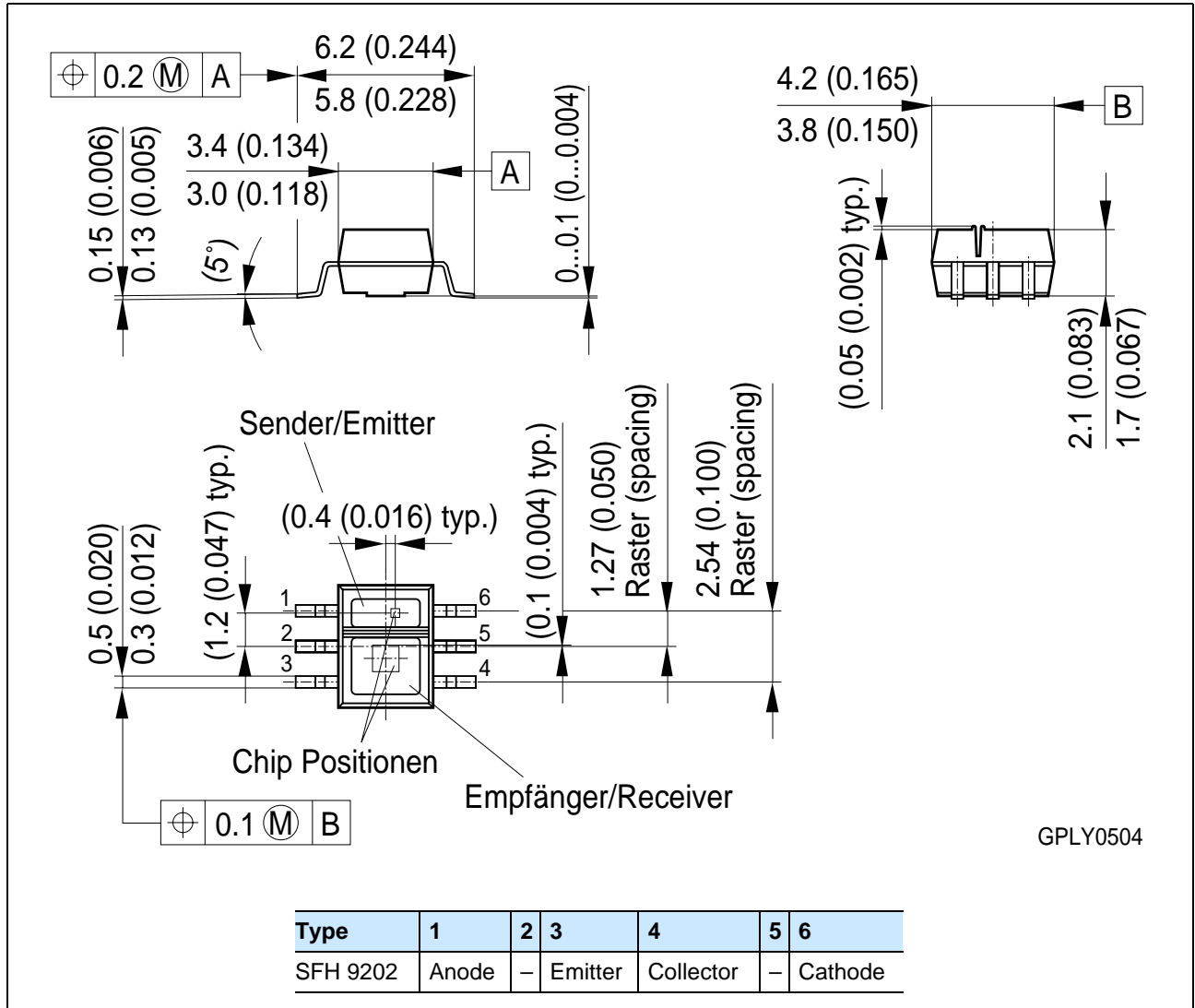

Maße in mm (inch) / Dimensions in mm (inch).

Empfohlenes Lötpad Design
Recommended Solder Pad

Reflow Lötén
 Reflow Soldering

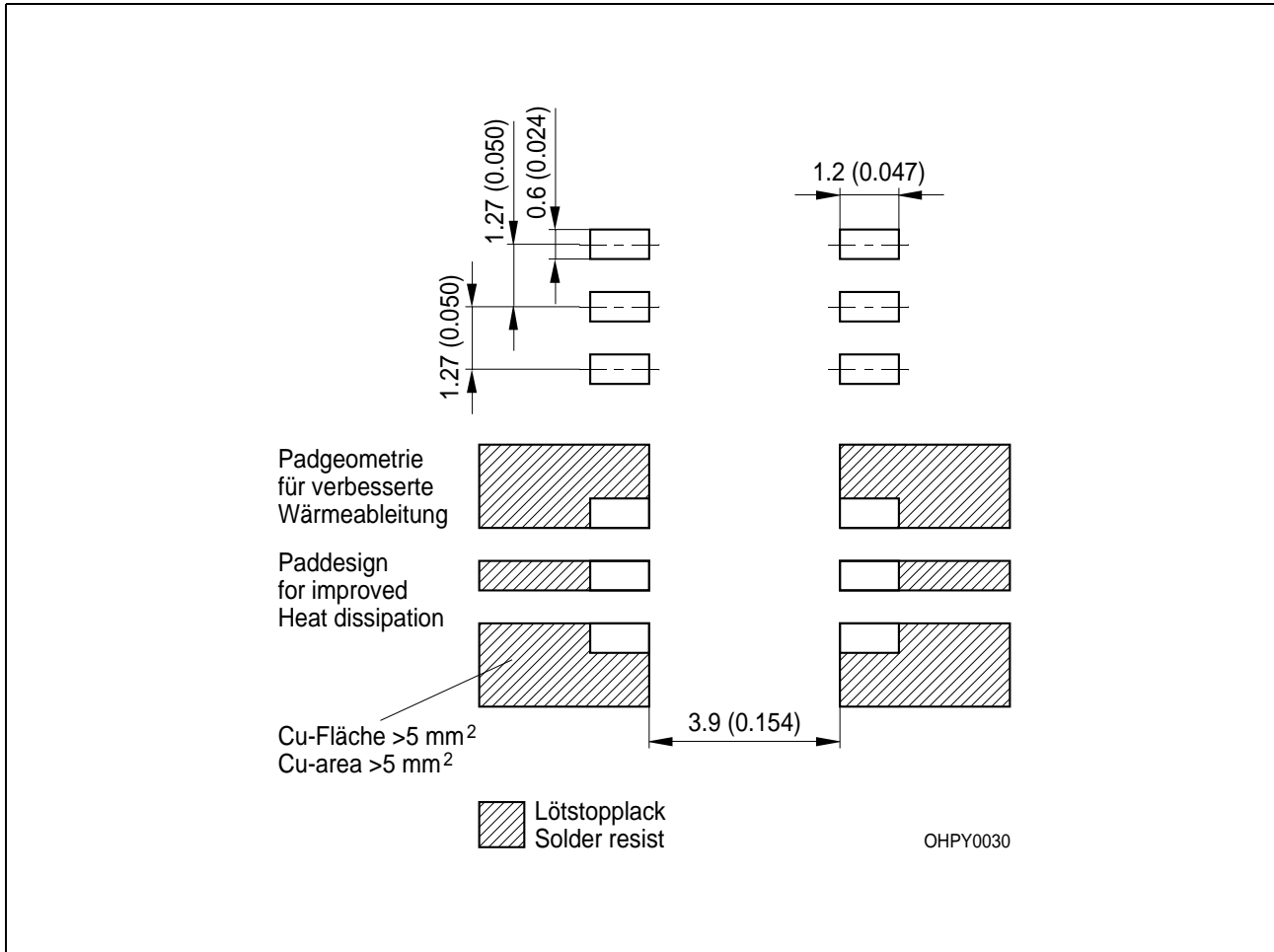

Maße in mm (inch) / Dimensions in mm (inch).

Löthinweise
Soldering Conditions

Bauform Type	Drypack Level acc. to IPS-stand. 020	Tauch-, Schwalllötung Dip, Wave Soldering		Reflowlötung Reflow Soldering		Kolbenlötung Iron Soldering (Iron temp.)
		Peak Temp. (solderbath)	Max. Time in peak zone	Peak Temp. (package temp.)	Max. Time in Peak Zone	
SFH 9202	4	n. a.	–	260 °C	20 sec.	n.a.

Lötbedingungen
Soldering Conditions
Reflow Lötprofil für bleifreies Löt
Reflow Soldering Profile for lead free soldering

Vorbehandlung nach JEDEC Level 4
Preconditioning acc. to JEDEC Level 4 (nach J-STD-020C)
(acc. to J-STD-020C)

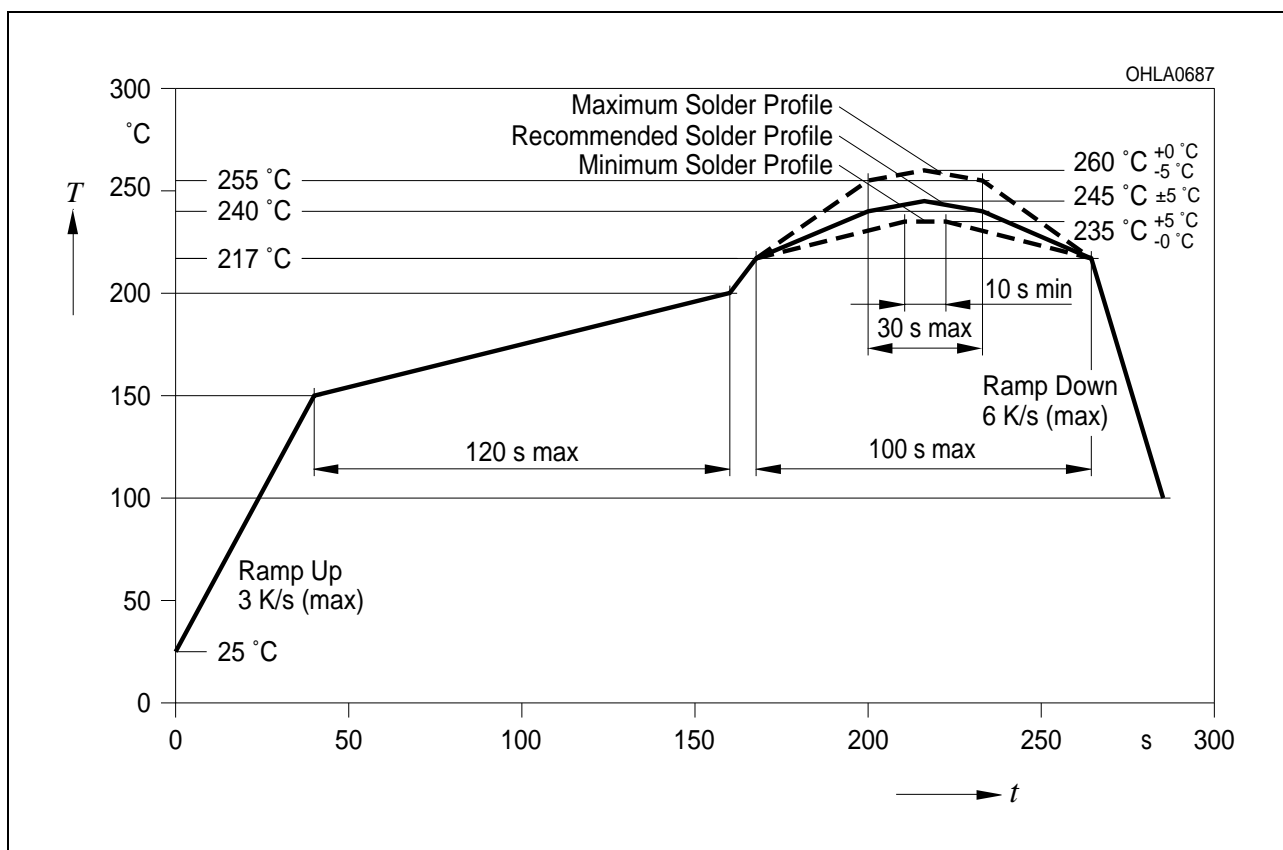

Gurtung / Polarität und Lage

siehe Dokument: Short Form Katalog: Gurtung und
Verpackung - SMT-Bauelemente - Gehäuse:SMT RLS

Methode of Taping / Polarity and Orientation

see document: Short Form Catalog: Tape and Reel -
SMT-Components - Package: SMT-RLS

Published by
OSRAM Opto Semiconductors GmbH
Leibnizstrasse 4, D-93055 Regensburg
www.osram-os.com
© All Rights Reserved.

EU RoHS and China RoHS compliant product



此产品符合欧盟 RoHS 指令的要求；

按照中国的相关法规和标准，不含有毒有害物质或元素。

The information describes the type of component and shall not be considered as assured characteristics. Terms of delivery and rights to change design reserved. Due to technical requirements components may contain dangerous substances. For information on the types in question please contact our Sales Organization.

Packing

Please use the recycling operators known to you. We can also help you – get in touch with your nearest sales office. By agreement we will take packing material back, if it is sorted. You must bear the costs of transport. For packing material that is returned to us unsorted or which we are not obliged to accept, we shall have to invoice you for any costs incurred.

Components used in life-support devices or systems must be expressly authorized for such purpose! Critical components ¹, may only be used in life-support devices or systems ² with the express written approval of OSRAM OS.

¹ A critical component is a component used in a life-support device or system whose failure can reasonably be expected to cause the failure of that life-support device or system, or to affect its safety or effectiveness of that device or system.

² Life support devices or systems are intended (a) to be implanted in the human body, or (b) to support and/or maintain and sustain human life. If they fail, it is reasonable to assume that the health of the user may be endangered.

2010-08-05

11