



128MB to 8GB
IDE Flash Disk Module



www.stec-inc.com

SLFDM(40/44)(V/H)-xxx(M/G)M1U(I)

Solid-State IDE Flash Disk Module
(No Moving Parts)

Capacity: 128MB - 8GB

ATA-5 Compatible

ATA Transfer modes:

- PIO 0-6, MWDMA 0-4

Supports TrueIDE and PC Card
Memory and I/O Modes

Form Factors:

- 40-Pin Vertical Plug-in
- 40-Pin Horizontal Plug in
- 40-Pin Vertical Plug-in, Housing
- 44-Pin Vertical Plug-in
- 44-Pin Horizontal Plug-in
- 44-Pin Vertical Plug-in, Housing

Endurance Guarantee of 2,000,000
Write/Erase Cycles

Master or Slave Select by Jumper

5V or 3.3V Power Supply

Commercial and Industrial
Operating Temperature Range

5-Byte Detection, 4-Byte Correction
ECC Engine

10 Year Data Retention

RoHS-6 Compliant

General Description and Key Features

STEC's flash storage adheres to the latest industry compliance and regulatory standards including UL, FCC, RoHS, and various compliance associations. Each device incorporates a proprietary state-of-the-art flash memory controller that provides the greatest flexibility to customer-specific applications while supporting key flash management features resulting in the industry's highest reliability and endurance. Key features include:

- Built-in ECC engine detects up to 5-byte and corrects up to 4-byte errors
- Sophisticated block management and wear leveling algorithms guarantees 2,000,000 write/erase cycles
- Power-down data protection ensures data integrity and errors in case of power loss
- Lifecycle management feature allows users to monitor the device's block management

STEC's IDE Flash Disk Module is the product of choice in applications requiring high reliability and high tolerance to shock, vibration, humidity, altitude, ESD, and temperature. The rugged industrial design combined with industrial temperature (-40°C to 85°C) testing and adherence to rigid JEDEC JESD22 standards ensures flawless execution in the harshest environments.

In addition to custom hardware and firmware designs, STEC also offers value-added services including:

- Custom labeling and packaging
- Custom software imaging and ID strings
- Full BOM control and product change notification
- Total supply-chain management to ensure continuity of supply
- In-field application engineering to help customers through product design-ins

Ordering Information: IDE Flash Disk Module

Part Number	Capacity
SLFDM(40/44)(V/H)-128MM1U(I)	128 Mbytes
SLFDM(40/44)(V/H)-256MM1U(I)	256 Mbytes
SLFDM(40/44)(V/H)-512MM1U(I)	512 Mbytes
SLFDM(40/44)(V/H)-1GM1U(I)	1 GByte
SLFDM(40/44)(V/H)-2GM1U(I)	2 GBytes
SLFDM(40/44)(V/H)-4GM1U(I)	4 GBytes
SLFDM(40/44)H-8GM1U(I)	8 GBytes

Legend:

- SLFDM** = STEC standard IDE Flash Disk Module part number prefix.
- (40/44)** = 40-pin IDE connector and 4-pin power connector (40) or a 44-pin IDE connector with power supply through the 44-pin IDE connector (44).
- (V/H)** = vertical (V) or horizontal (H) plug-in.
- (M/G)** = proceeding capacity (xxx) is in Megabytes (M) or Gigabytes (G).
- M1** = STEC Mach 1 controller.
- U** = RoHS-6 compliant lead-free.
- Part numbers without (I)** = Commercial temperature range (0°C to 70°C).
- (I)** = Industrial temperature range (-40°C to +85 °C).
- Part numbers with S before dash** = optional housing (e.g. SLFDM(40/44)VS-xxx(M/G)M1U(I)).

Table of Contents

General Description and Key Features.....	1
Ordering Information: IDE Flash Disk Module	1
1.0 Product Specifications	3
1.1 Package Dimensions, Pin Locations, and Master/Slave Jumpers	3
1.1.1 40-Pin Vertical Plug-in.....	3
1.1.2 40-Pin Horizontal Plug-in.....	4
1.1.3 40-Pin Vertical Plug-in with Housing	5
1.1.4 44-Pin Vertical Plug-in.....	6
1.1.5 44-Pin Horizontal Plug-in.....	7
1.1.6 44-Pin Vertical Plug-in with Housing	8
1.2 Pin Assignment.....	9
1.3 Signal Descriptions	10
1.4 Performance	11
1.5 CHS Parameters	11
1.6 Standards Compliance	12
1.6.1 CE and FCC Class B & D	12
1.6.2 RoHS.....	12
2.0 Environmental Specifications.....	13
2.1 Recommended Operating Conditions	13
2.2 Reliability	13
2.3 Shock, Vibration, and Humidity	13
3.0 Electrical Specifications	14
3.1 Absolute Maximum Ratings.....	14
3.2 DC Characteristics.....	14
3.3 AC Characteristics.....	15
3.3.1 True IDE Mode Register Access.....	15
3.3.2 True IDE Mode PIO Access	16
3.3.3 True IDE Mode Multiword DMA	18
4.0 Identify Drive Parameter Information	19
5.0 Registers	20
6.0 Supported ATA Commands	21
7.0 Revision History	23

1.0 Product Specifications

1.1 Package Dimensions, Pin Locations, and Master/Slave Jumpers

1.1.1 40-Pin Vertical Plug-in

Table 1 and Figure 1 show the mechanical dimensions of the 40-pin vertical plug-in module.

Table 1: Mechanical dimensions 40-pin vertical plug-in module

Parameter	Value
Length	54.23 ± 0.127 mm (2.135 ± 0.005 in)
Width	32.00 ± 0.140 mm (1.260 ± 0.055 in)
Height	12.65 mm (0.498 in) nominal

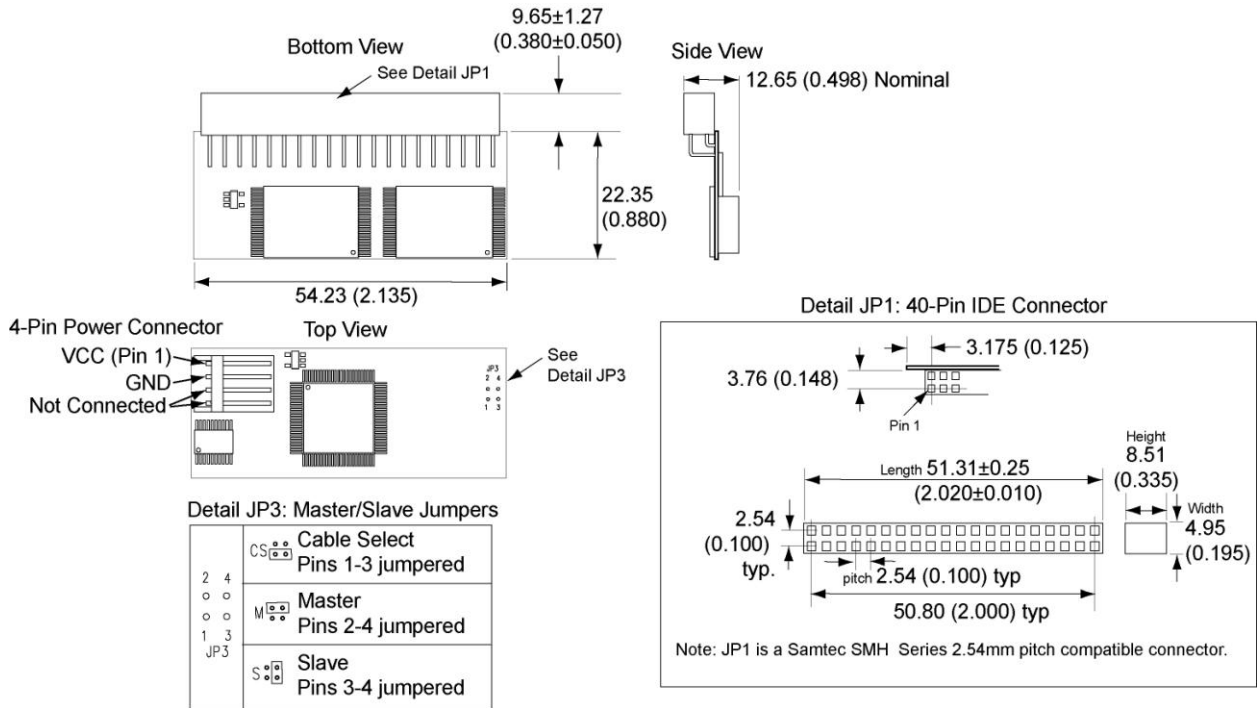

Figure 1: Mechanical dimensions 40-pin vertical plug-in module

1.1.2 40-Pin Horizontal Plug-in

Table 2 and Figure 2 show the mechanical dimensions of the 40-pin horizontal plug-in module.

Table 2: Mechanical dimensions 40-pin horizontal plug-in module

Parameter	Value
Length	54.23 ± 0.127 mm (2.135 ± 0.005 in)
Width	22.35 ± 0.127 mm (0.880 ± 0.005 in)
Height	16.33 mm (0.643 in) nominal

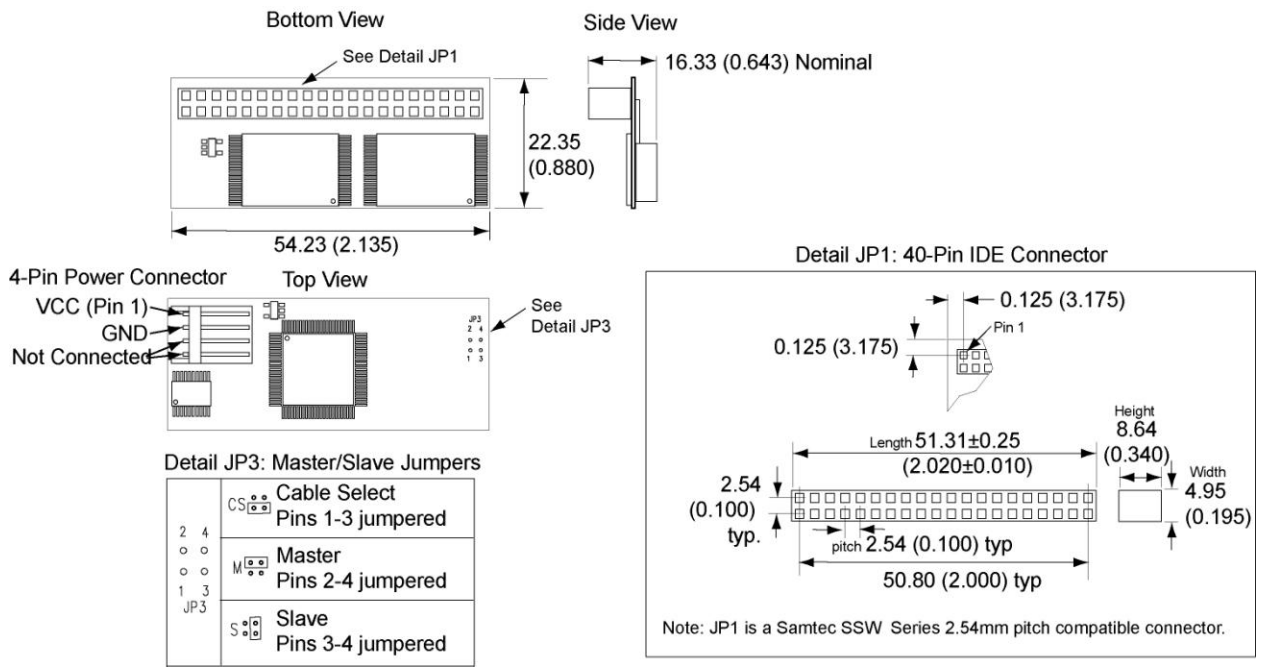

Figure 2: Mechanical dimensions 40-pin horizontal plug-in module

1.1.3 40-Pin Vertical Plug-in with Housing

Table 3 and Figure 3 show the mechanical dimensions of the 40-pin vertical plug-in module with Housing.

Table 3: Mechanical dimensions 40-pin vertical plug-in module with housing

Parameter	Value
Length	58.80 mm (2.315 in) typ
Width	27.69 mm (1.090 in) typ
Height	6.40 mm (0.252 in) typ

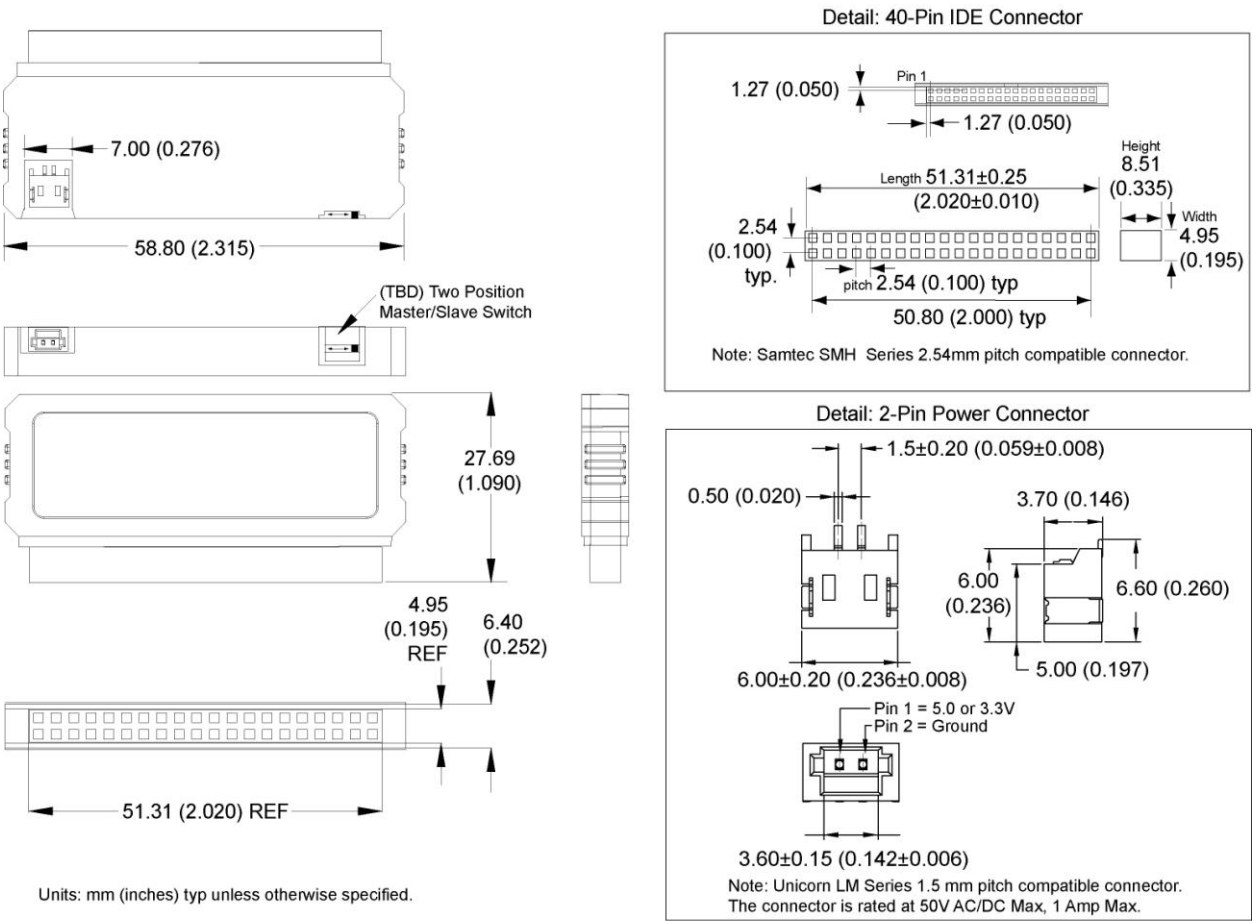

Figure 3: Mechanical dimensions 40-pin vertical plug-in module with housing

1.1.4 44-Pin Vertical Plug-in

Table 4 and Figure 4 show the mechanical dimensions of the 44-pin vertical plug-in module.

Table 4: Mechanical dimensions 44-pin vertical plug-in module

Parameter	Value
Length	50.80 ± 0.127 mm (2.000 ± 0.005 in)
Width	40.13 ± 0.140 mm (1.580 ± 0.055 in)
Height	11.10 mm (0.437 in) nominal

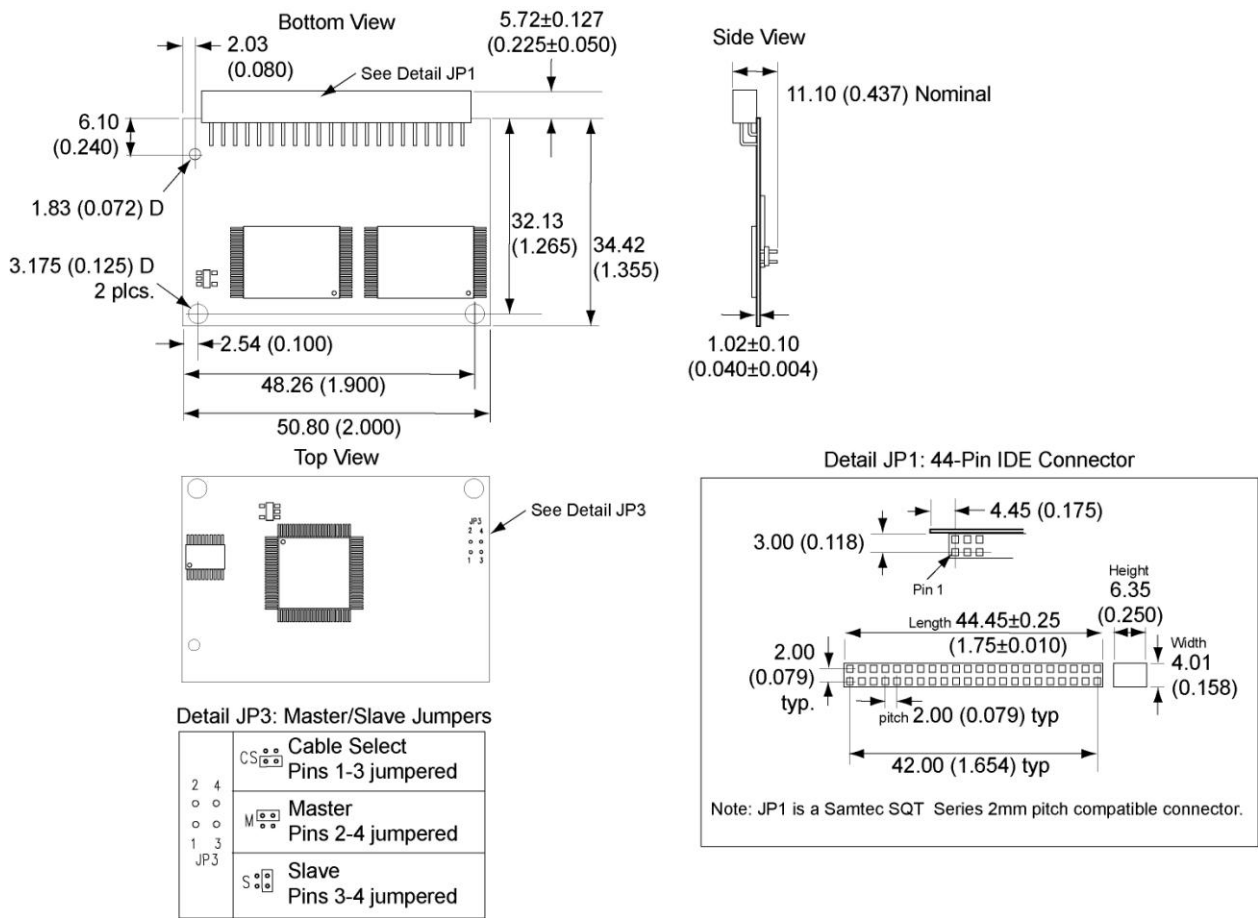

Figure 4: Mechanical dimensions 44-pin vertical plug-in module

1.1.5 44-Pin Horizontal Plug-in

Table 5 and Figure 5 show the mechanical dimensions of the 44-pin horizontal plug-in module.

Table 5: Mechanical dimensions 44-pin horizontal plug-in module

Parameter	Value
Length	50.80 ± 0.127 mm (2.000 ± 0.005 in)
Width	29.46 ± 0.127 mm (1.160 ± 0.005 in)
Height	14.71 mm (0.579 in) nominal

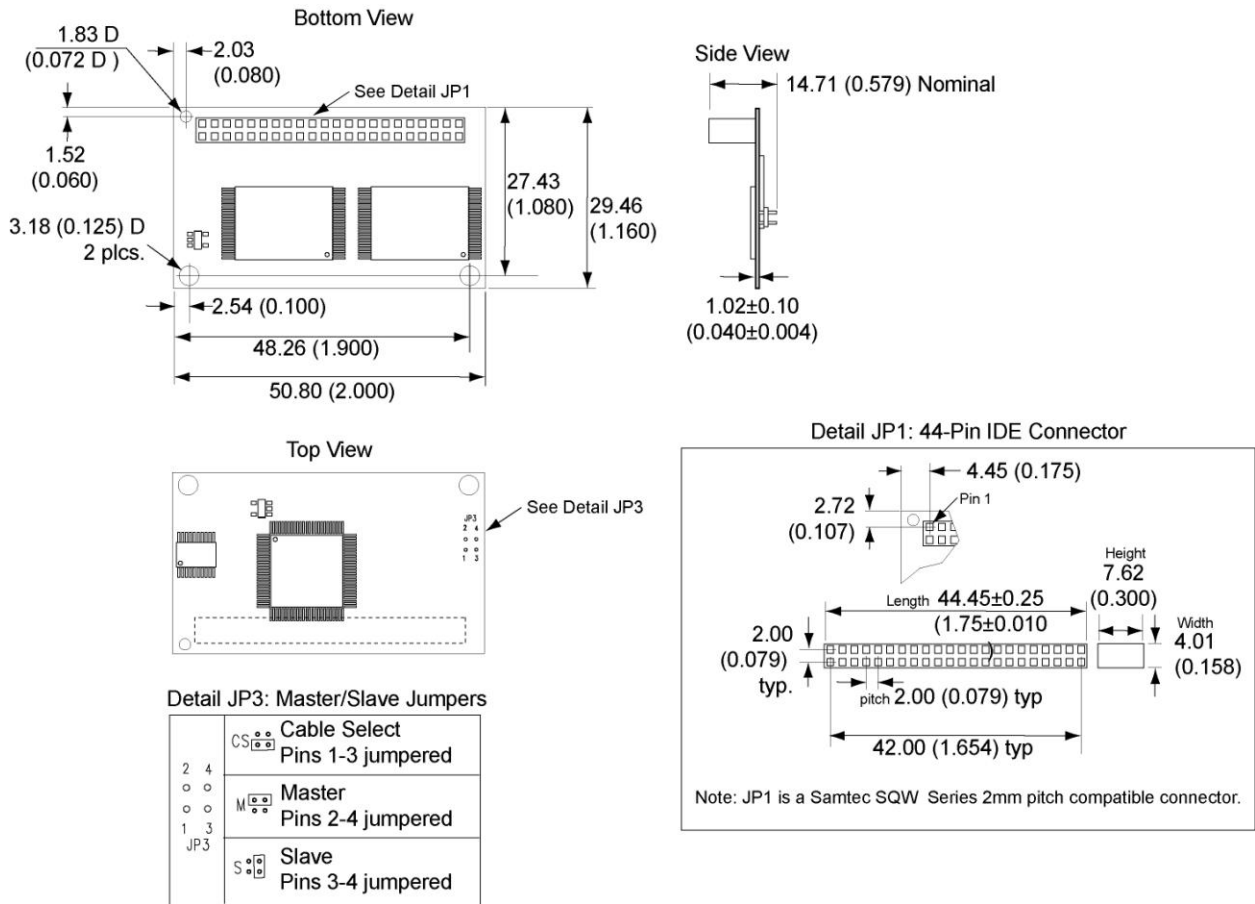

Figure 5: Mechanical dimensions 44-pin horizontal plug-in module

1.1.6 44-Pin Vertical Plug-in with Housing

Table 6 and Figure 6 show the mechanical dimensions of the 44-pin vertical plug-in module with Housing.

Table 6: Mechanical dimensions 44-pin vertical plug-in module with housing

Parameter	Value
Length	52.30 mm (2.059 in) typ
Width	28.20 mm (1.210 in) typ
Height	7.15 mm (0.281 in) typ

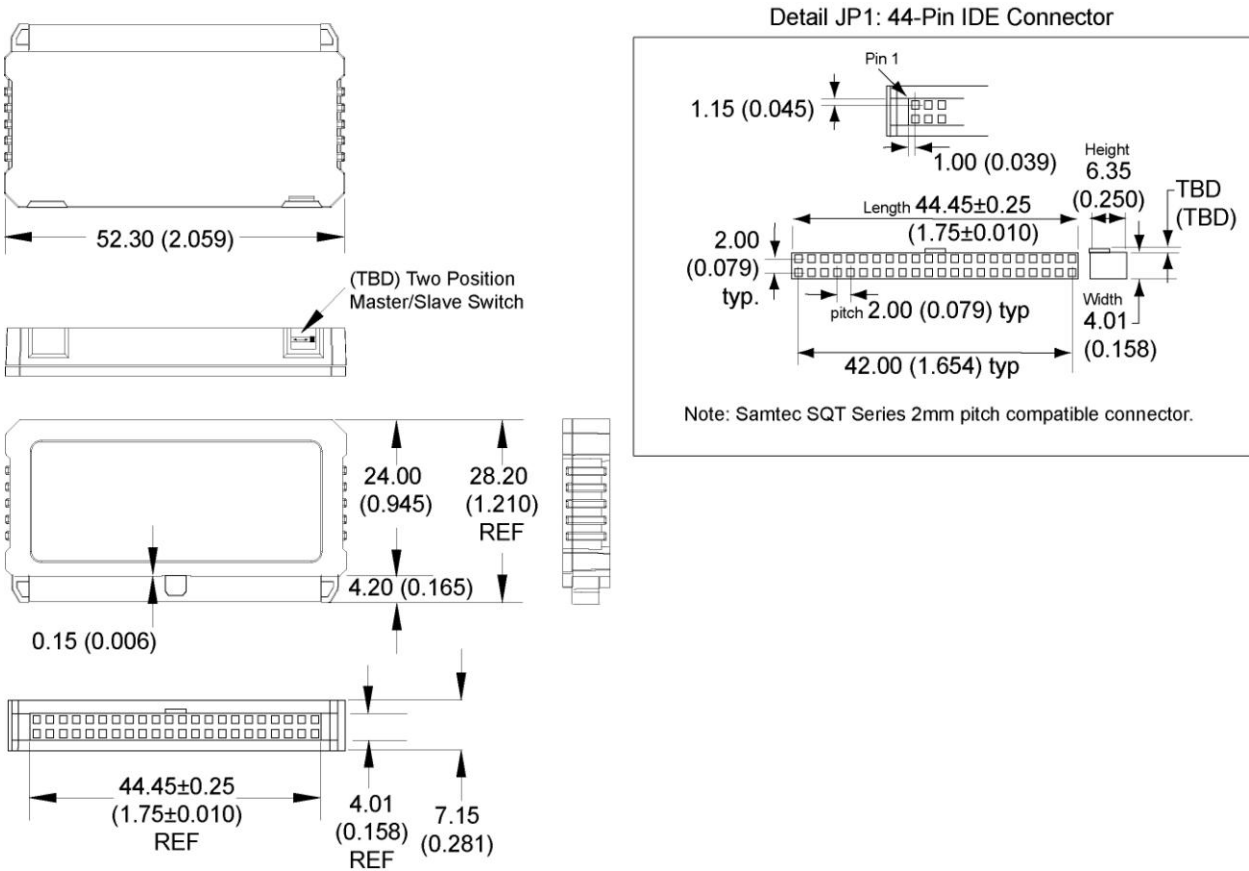

Units: mm (inches) typ unless otherwise specified.

Figure 6: Mechanical dimensions 44-pin vertical plug-in module with housing

1.2 Pin Assignment

Table 7: IDE Flash Disk Module Pin Assignment

Pin Number	Signal Name	Pin Type	Pin Number	Signal Name	Pin Type
1	-RESET	I	23	-IOWR	I
2	GND	Ground	24	GND	Ground
3	D07	I/O	25	-IORD	I
4	D08	I/O	26	GND	Ground
5	D06	I/O	27	-IORDY	O
6	D09	I/O	28	-CSEL (not used on housed modules)	I
7	D05	I/O	29	-DMACK	I
8	D10	I/O	30	GND	Ground
9	D04	I/O	31	INTRQ	O
10	D11	I/O	32	-IOCS16	O
11	D03	I/O	33	A1	I
12	D12	I/O	34	-PDIAG	I/O
13	D02	I/O	35	A0	I
14	D13	I/O	36	A2	I
15	D01	I/O	37	-CS0	I
16	D14	I/O	38	-CS1	I
17	D00	I/O	39	-DASP	I/O
18	D15	I/O	40	GND	Ground
19	GND	Ground	41	VCC (44-pin version only)	Power
20	Key	Key	42	VCC (44-pin version only)	Power
21	DMARQ	O	43	GND (44-pin version only)	Ground
22	GND	Ground	44	NC (44-pin version only)	No Connect

Legend: "-" = Low active

1.3 Signal Descriptions

Signal Name	Dir	Pin	Description
-DASP	I/O	39	This input/output is the Disk Active/Slave Present signal in the Master/ Slave handshake protocol.
D15-D00	I/O	18, 16, 14, 12, 10, 8, 6, 4, 3, 5, 7, 9, 11, 13, 15, 17	All Task File operations occur in byte mode on the low order bus D00-D07 while all data transfers are 16 bit using D00-D15.
-IOWR	I	23	The I/O Write strobe pulse is used to clock I/O data on the module Data bus into the Module controller registers when the Module is configured to use the I/O interface. The clocking will occur on the negative to positive edge of the signal (trailing edge).
-IORD	I	25	This is an I/O Read strobe generated by the host. This signal gates I/O data onto the bus from the Module.
INTRQ	O	31	Signal is the active high Interrupt Request to the host.
A2-A0	I	35, 33, 36	A[2:0] are used to select the one of eight registers in the Task File.
-CS0, -CS1	I	37, 38	-CS0 is the chip select for the task file registers while -CS1 is used to select the Alternate Status Register and the Device Control Register.
-CSEL (not used on housed modules)	I	28	This internally pulled up signal is used to configure the card as a Master or Slave. When the pin is grounded, the card is configured as a Master. When the pin is open, the card is configured as a Slave.
-IOCS16	O	32	Not used.
-PDIAG	I/O	34	This input/output is the Pass Diagnostic signal in the Master/Slave handshake protocol.
DMARQ	O	21	This signal is asserted by the device when it is ready to transfer data to/ from the host. Data direction is controlled by -IORD and -IOWR. This signal is used in a handshake manner with -DMACK.
-DMACK	I	29	This input signal is used by host in response to DMARQ to initiate DMA transfers.
-IORDY	O	27	Not used, and pulled up to VCC through a 4.7K ohm resistor.
-RESET	I	1	This input pin is the active low hardware reset from the host.
VCC (44-pin version only)	—	41, 42	Power.
GND (Pin 43 present on 44-pin version only)	—	2, 19, 22, 24, 26, 30, 40, 43	Ground.
Key	—	20	This pin is keyed to ensure cable is connected with the proper orientation.
NC (44-pin version only)	—	44	No connect.

1.4 Performance

Table 8: IDE Flash Disk Module Read/Write Performance

Parameter	Value
Data transfer rate to/from host	16.7 MBytes/s (burst)
Sustained read	up to 10 MBytes/s
Sustained write	up to 7 MBytes/s

1.5 CHS Parameters

Table 9: CHS Parameters per capacity

Capacity	Cylinder (C)	Head (H)	Sectors/Track (S)
128MB	980	8	32
256MB	980	16	32
512MB	993	16	63
1GB	1,986	16	63
2GB	3,970	16	63
4GB	7,964	16	63
8GB	16,062	16	63

1.6 Standards Compliance

STEC products specified in this document are compliant with Technical Committee T13, AT Attachment-5 (ATA-5) standards and are certified for compliance with these other industry standards:

- UL 950
- CE, and FCC Class B & D
- RoHS

1.6.1 CE and FCC Class B & D

The STEC products specified in this document meet the following requirements and limits of the European Standards:

- **Class B** requirements of the following European Standard:

EN 55022: 1998 – “Information technology equipment – Radio disturbance characteristics – Limits and methods of measurement”

- **Class D** limits of the following European Standards:

EN 61000-3-2 “Electromagnetic compatibility (EMC) Part 3-2: Limits – Limits for harmonic current emissions (equipment input current up to and including 16 A per phase)”

EN 61000-3-3: 1995 – “Part 3: Limits – Section 3: Limitation of voltage fluctuations and flicker in low-voltage supply systems for equipment with rated current $\leq 16A$ ”

EN 55024 – “Information technology equipment – Immunity characteristics – Limits and methods of measurement”

1.6.2 RoHS

STEC certifies that its products do not contain any of the restricted substances as stated below and are in compliance with RoHS EU directive 2002/95/EC, specifically:

- Mercury (Hg)
- Cadmium Cd)
- Chromium VI (Cr +6)
- Polybrominated biphenyl (PBB)
- Polybrominated biphenyl ether (PBDE)
- Lead (Pb)

Materials used in the STEC’s products are limited to the following:

- Steel, Nylon 6/6, PCB laminate
- Copper, Gold, Nickel
- Silicon on ICs and Components
- Polyester on Labels

2.0 Environmental Specifications

2.1 Recommended Operating Conditions

Table 10: IDE Flash Disk Module Recommended Operating Conditions

Parameter	Symbol	Min	Typ	Max	Unit
Commercial Operating Temperature	Ta	0	25	70	°C
Industrial Operating Temperature	Ta	-40	-	85	°C
VCC voltage 5.0	VCC5	4.75	5.0	5.25	V
VCC voltage 3.3	VCC3.3	3.18	3.3	3.465	V

2.2 Reliability

Table 11: IDE Flash Disk Module Endurance & Data Reliability

Parameter	Value
Endurance	2,000,000 Write/Erase Cycles
Data reliability	1 in 10 ¹⁴ bits, read
Data retention	10 years

2.3 Shock, Vibration, and Humidity

Table 12: IDE Flash Disk Module Shock, Vibration & Humidity

Parameter	Value
Shock	1.5K G peak, 0.5ms pulse duration, five (5) pulses per each of six (6) directions (per JEDEC JESD22 standard, method B110)
Vibration	20 G peak, 20Hz-2000Hz, 4 cycles per direction (per JEDEC JESD22 standard, method B103)
Humidity	85°C 85% RH, 500 hrs

3.0 Electrical Specifications

3.1 Absolute Maximum Ratings

Table 13: IDE Flash Disk Module Absolute Maximum Ratings

Parameter	Symbol	Value	Unit
Voltage	Vin, Vout	-0.5 to VCC +0.5	V
Storage temperature range	Tstg	-65 to +150	°C

3.2 DC Characteristics

Measurements at Recommended Operating Conditions unless otherwise specified.

Table 14: IDE Flash Disk Module DC Characteristics

Symbol	Parameter	Min	Max	Unit	Notes
VIL	Input LOW Voltage	-0.3	+0.8	V	VCC=3.3V or 5.0V
VIH	Input HIGH Voltage	2.0	VCC +0.3	V	VCC=3.3V or 5.0V
VOL3.3	Output LOW Voltage 3.3		0.45	V	VCC=3.3V
VOL5	Output LOW Voltage 5		0.8		VCC=5.0V
VOH	Output HIGH Voltage	2.4		V	VCC=3.3V or 5.0V
ICCSB	Standby Mode		2	mA	ICC at VCC=3.3V or 5.0V
ICC	Operating Current		75	mA	ICC at VCC=3.3V or 5.0V Operating current measured with 2-way interleaving.
ILI	Input Leakage Current		10	µA	VCC=3.3V or 5.0V
ILO3.3	Output Leakage Current 3.3		1	µA	VCC=3.3V
ILO5	Output Leakage Current 5		2	µA	VCC= 5.0V
CI/O	Input/output Capacitance		25	pF	VCC=3.3V or 5.0V

3.3 AC Characteristics

Measurements at Recommended Operating Conditions, unless otherwise specified.

3.3.1 True IDE Mode Register Access

Table 15: True IDE Mode Register Access AC Characteristics

Parameter	Symbol	Mode0	Mode1	Mode2	Mode3	Mode4	Mode5	Mode6	Unit
Cycle time (min)	t0	600	383	330	180	120	100	80	ns
Address valid to -IORD/-IOWR (min) setup	t1	70	50	30	30	25	15	10	ns
-IORD/-IOWR pulse width 8bit (min)	t2	290	290	290	80	70	65	55	ns
-IORD/-IOWR recovery time (min)	t2i	—	—	—	70	25	25	20	ns
-IOWR data setup (min)	t3	60	45	30	30	20	20	15	ns
-IOWR data hold (min)	t4	30	20	15	10	10	5	5	ns
-IORD data setup (min)	t5	50	35	20	20	20	15	10	ns
-IORD data hold (min)	t6	5	5	5	5	5	5	5	ns
-IORD data tristate (max)	t6z	30	30	30	30	30	20	20	ns
Addresses valid to -IOCS16 assert. (max)	t7	90	50	40	N/A	N/A	N/A	N/A	ns
Address valid to -IOCS16 release (max)	t8	60	45	30	N/A	N/A	N/A	N/A	ns
-IORD/-IOWR to address valid hold	t9	20	15	10	10	10	10	10	ns

3.3.2 True IDE Mode PIO Access

Table 16: True IDE Mode PIO Access AC Characteristics

Parameter	Symbol	Mode0	Mode1	Mode2	Mode3	Mode4	Mode5	Mode6	Unit
Cycle time (min)	t0	600	383	330	180	120	100	80	ns
Address valid to -IORD/-IOWR (min) setup	t1	70	50	30	30	25	15	10	ns
-IORD/-IOWR pulse width 8bit (min)	t2	290	290	290	80	70	65	55	ns
-IORD/-IOWR recovery time (min)	t2i	—	—	—	70	25	25	20	ns
-IOWR data setup (min)	t3	60	45	30	30	20	20	15	ns
-IOWR data hold (min)	t4	30	20	15	10	10	5	5	ns
-IORD data setup (min)	t5	50	35	20	20	20	15	10	ns
-IORD data hold (min)	t6	5	5	5	5	5	5	5	ns
-IORD data tristate (max)	t6z	30	30	30	30	30	20	20	ns
Addresses valid to -IOCS16 assert. (max)	t7	90	50	40	N/A	N/A	N/A	N/A	ns
Address valid to -IOCS16 release	t8	60	45	30	N/A	N/A	N/A	N/A	ns
-IORD/-IOWR to address valid hold	t9	20	15	10	10	10	10	10	ns

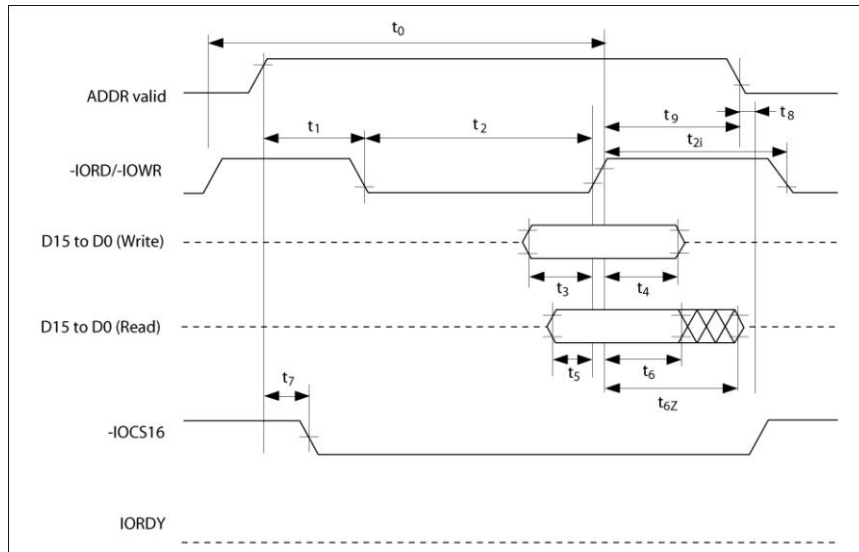

Figure 7: True IDE Mode PIO Access Timing Diagram

3.3.3 True IDE Mode Multiword DMA

Table 17: True IDE Mode Multiword DMA AC Characteristics

Parameter	Symbol	Mode 0	Mode 1	Mode 2	Mode 3	Mode 4	Unit
Cycle time (min)	t_0	480	150	120	100	80	ns
-IORD/-IOWR Asserted Pulse (min)	t_D	215	80	70	65	55	ns
-IORD data access (max)	t_E	150	60	50	50	45	ns
-IORD data hold (min)	t_F	5	5	5	5	5	ns
-IORD/-IOWR data setup (min)	t_G	100	30	20	15	10	ns
-IOWR data hold (min)	t_H	20	15	10	5	5	ns
DMACK to -IORD/-IOWR setup (min)	t_I	0	0	0	0	0	ns
-IORD/-IOWR to DMACK hold (min)	t_J	20	5	5	5	5	ns
-IORD negated pulse width (max)	t_{KR}	50	50	25	25	20	ns
-IOWR negated pulse width (min)	t_{KW}	215	50	25	25	20	ns
-IORD to DMARQ delay (max)	t_{LR}	120	40	35	35	35	ns
-IOWR to DMARQ delay (max)	t_{LW}	40	40	35	35	35	ns

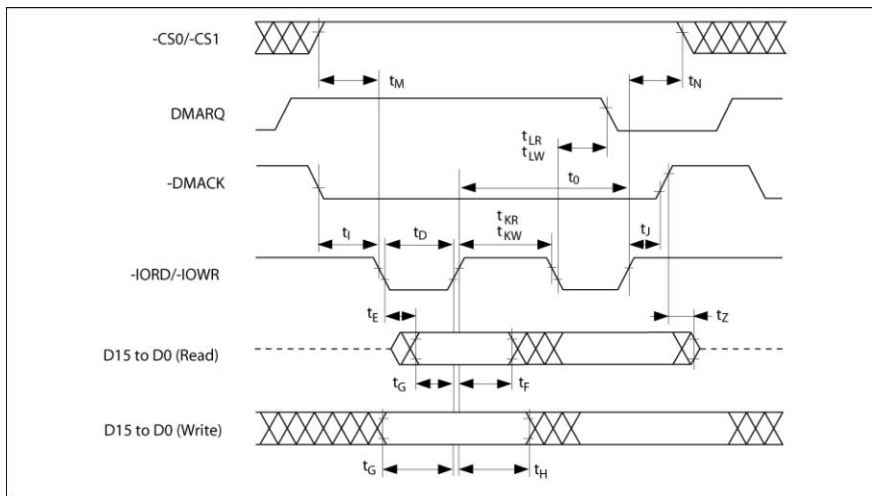

Figure 8: True IDE Mode Multiword DMA Timing Diagram

4.0 Identify Drive Parameter Information

An example of the parameter information received from the IDE Flash Disk Module when invoking the Identify Drive command (ECh) is listed in Table 18.

Table 18: Identify Drive Parameter Information

Word Address	Data	Total Bytes	Description
0	044AH	2	Value fixed by CFA
1	XXXXH	2	Default number of cylinders
2	0000H	2	Reserved
3	00XXH	2	Default number of heads
4	XXXXH	2	Do not use this word. Before retirement, was number of unformatted bytes per track
5	XXXXH	2	Do not use this word. Before retirement, was number of unformatted bytes per sector
6	XXXXH	2	Default number of sectors per track
7 - 8	XXXXH	4	Number of sectors per IDE Flash Disk Module (word 7 = MSW, word 8 = LSW)
9	0000H	2	Reserved
10 - 19	Unique per card	20	Serial Number in ASCII (20 characters): STEC proprietary
20	XXXXH	2	Do not use this word. Before retirement, was buffer type
21	XXXXH	2	Do not use this word. Before retirement, was buffer size in 512 byte increments
22	0004H	2	# of ECC bytes passed on Read/Write Long commands
23 - 26	See description	8	Firmware revision in ASCII (8 characters): Rev8.0.0 52 65 76 38 2E 30 2E 30 hex
27 - 46	See description	40	Model Number in ASCII (40 characters): STI Flash 8.0.0 <left justified> 53 54 49 20 46 6C 61 73 68 20 38 2E 30 2E 30 20 hex
47	0001H	2	Maximum of 1 sector on Read/Write Multiple command
48	0000H	2	Double Word not supported
49	0300H	2	DMA supported, LBA supported
50	0000H	2	Reserved
51	0200H	2	PIO data transfer cycle timing mode
52	0000H	2	Single word DMA data transfer cycle timing mode (not supported)
53	0003h	2	Words 54 - 58 and 64 - 70 are valid
54	XXXXH	2	Number of Current Cylinders
55	XXXXH	2	Number of Current Heads
56	XXXXH	2	Number of Current Sectors Per Track
57	XXXXH	2	LSW of the Current Capacity in Sectors
58	XXXXH	2	MSW of the Current Capacity in Sectors
59	010XH	2	Current Setting for Block Count=1 for R/W Multiple commands
60 - 61	XXXXH	4	Total number of sectors addressable in LBA Mode
62	0000H	2	Single word DMA transfer not supported
63	0407H	2	Multiword DMA modes supported
64	0003H	2	Advanced PIO modes supported (modes 3 and 4)
65	0078H	2	Minimum multiword DMA transfer cycle time per word (ns)
66	0078H	2	Recommended multiword DMA transfer cycle time per word (ns)
67	0078H	2	Minimum PIO transfer without flow control
68	0078H	2	Minimum PIO transfer with IORDY flow control
69 - 255	0000H	374	Reserved

XXXXH = These values depend on the specific IDE Flash Disk Module.

5.0 Registers

This chapter lists the registers of the IDE Flash Disk Module. Refer to ATA/IDE standards for further details, including Task File Register mapping and bit definitions of each Task File Register.

The Data Register is accessed in word (16-bit) mode at power up. The IDE Flash Disk Module permits 8-bit accesses if the host issues a Set Feature Command to put the IDE Flash Disk Module in 8-bit mode.

Table 19: IDE Flash Disk Module Task File Registers

Task File Register	Description
Data Register	The Data Register is a 16-bit read/write register used for transferring data between the IDE Flash Disk Module and the host. This register can be accessed in word mode and byte mode.
Error Register	The Error Register is a read-only register that is used for analyzing an error. This register is valid when the BSY bit in the Status register and Alternate Status register are set to "0" (Ready). Diagnostic Codes are returned in the Error Register after an Execute Drive Diagnostic command (code 90h). Extended Error Codes returned in the Error Register after a Request Sense command (code 03h).
Sector Count Register	This register contains the numbers of sectors of data requested to be transferred on a read or write operation between the host and the IDE Flash Disk Module. If the value in the register is 0, a count of 256 sectors is indicated.
Sector Number Register	When the LBA bit in the Drive/Head register is 0, this register contains the starting sector number for any media access. When the LBA bit is set to 1, this register contains bits 7:0 of the LBA for any media access.
Cylinder Low Register	In CHS mode (LBA=0), this register contains the low-order bits of the starting cylinder address. In LBA mode, it contains bits 15:8 of the LBA.
Cylinder High Register	In CHS mode (LBA=0), this register contains the high-order bits of the starting cylinder address. In LBA mode, it contains bits 23:16 of the LBA.
Drive/Head Register	This register selects the IDE Flash Disk Module address translation (CHS or LBA) and provides head address (CHS) or high-order address bits 27:24 for LBA.
Status Register	This read-only register indicates status of a command execution. When the BSY bit is "0", the other bits are valid; when the BSY bit is "1", the other bits are not valid. When the register is read, the interrupt pin, is cleared.
Alternate Status Register	This register is the same as the Status register, except that is not negated when the register is read.
Device Control Register	This write-only register is used for controlling the interrupt request and issuing an ATA soft reset to the IDE Flash Disk Module.
Drive Address Register	This read-only register is used for confirming the IDE Flash Disk Module's status. This register is provided for compatibility with the AT disk drive interface and it is not recommended that this register be mapped into the host's I/O space because of potential conflicts on bit 7.
Command Register	This write-only register is used for writing the command that executes the Disk Module's operation. The command code is written in the command register after its parameters are written in the Task File during the Disk Module ready state.

6.0 Supported ATA Commands

The ATA commands used by the IDE Flash Disk Module are listed in Table 20. Refer to ATA/IDE standards for details.

Table 20: IDE Flash Disk Module Supported ATA Commands

Command Set	Code	Description
Check Power Mode	E5h or 98h	This command checks the power mode.
Execute Drive Diagnostic	90h	Command performs the internal diagnostic tests implemented by the Disk Module. Diagnostic Code is returned in Error Register.
Erase Sector(s)	C0h	Command is used to pre-erase/condition data sectors in advance.
Format Track	50h	Command writes the desired head/cylinder of the selected drive with a vendor unique data pattern (typically 00h or FFh). This Disk Module accepts a sector buffer of data from the host to follow the command with the same protocol as the Write Sector Command although the information in the buffer is not used.
Identify Drive	ECh	Command lets the host receive parameter information from the Disk Module in the same protocol as Read Sector(s) command.
Idle	E3h or 97h	Command causes the Disk Module to set BSY, enter the Idle mode, clear BSY, and generate an interrupt. If sector count is non-zero, automatic power down mode is enabled. If sector count is zero, the automatic power down mode is disabled.
Idle Immediate	E1h or 95h	This command causes the IDE Flash Disk Module to set BSY, enter the Idle mode, clear BSY, and generate an interrupt.
Initialize Drive Parameters	91h	This command enables the host to set the number of sectors per track and the number of heads per cylinder.
NOP	00h	No Operation.
Read Buffer	E4h	This command enables the host to read the current contents of the IDE Flash Disk Module's sector buffer.
Read DMA	C8h	Command is sector read command used for MWDMA transfer.
Read Multiple	C4h	Command performs similarly to the Read Sectors command. Interrupts are not generated on each sector, but on transfer of a block which contains the number of sectors defined by a Set Multiple command.
Read Long Sector	22h or 23h	Command performs similarly to the Read Sector(s) command except that it returns 516 bytes of data instead of 512 bytes.
Read Sector(s)	20h (w/ retry) 21h (w/o retry)	Command reads from 1 to 256 sectors as specified in the Sector Count register. Sector count of 0 requests 256 sectors. Transfer begins at the sector specified in the Sector Number register.
Read Verify Sector(s)	40h (w/ retry) 41h (w/o retry)	This command verifies one or more sectors on the Disk Module by transferring data from the flash media to the data buffer in the Disk Module and verifying that the ECC is correct. This command is identical to the Read Sectors command, except that DRQ is never set and no data is transferred to the host.
Recalibrate	1Xh	The Disk Module performs only the interface timing and register operations. When this command is issued, the Disk Module sets BSY and waits for an appropriate length of time, after which it clears BSY and issues an interrupt. When this command ends normally, the Disk Module is initialized.
Request Sense (Extended Error)	03h	Command requests extended error code after command ends with error. Extended error code is returned in the Error Register
Seek	7Xh	This command is effectively a NOP command to the Disk Module although it does perform a range check.

Command Set	Code	Description
Set Features	EFh	This command is used by the host to establish or select certain features.
Set Multiple Mode	C6h	This command enables the IDE Flash Disk Module to perform multiple read and write operations and establishes the block count for these commands.
Set Sleep Mode	E6h or 99h	This is the only command that allows the host to set the IDE Flash Disk Module into Sleep mode. When the IDE Flash Disk Module is set to sleep mode, the IDE Flash Disk Module clears the BSY line and issues an interrupt. The IDE Flash Disk Module enters sleep mode and the only method to make the IDE Flash Disk Module active again (back to normal operation) is by performing a hardware reset or a software reset.
Stand By	E2h or 96h	This command sets the IDE Flash Disk Module in Standby mode. If the Sector Count Register is a value other than 0H, an Auto Power Down is enabled and when the IDE Flash Disk Module returns to the idle mode, the timer starts a countdown. The time is set in the Sector Count Register.
Stand By Immediate	E0h or 94h	This command causes the Disk Module to set BSY, enter the Standby mode, clear BSY and return the interrupt immediately.
Translate Sector	87h	This command allows the host a method of determining the exact number of times a user sector has been erased and programmed. This command is not supported.
Wear Level	F5h	This command is effectively a NOP command and only implemented for backward compatibility. The Sector Count Register will always be returned with an 00h indicating Wear Level is not needed.
Write Buffer	E8h	This command enables the host to overwrite the contents of the Disk Module's sector buffer with any data pattern desired.
Write DMA	CAh	This command is the sector write command used for Multiword DMA transfer.
Write Long Sector	32h or 33h	This command is provided for compatibility purposes and is similar to the Write Sector(s) command except that it writes 516 bytes instead of 512 bytes.
Write Multiple	C5h	This command is similar to the Write Sectors command. Interrupts are not presented on each sector, but on the transfer of a block which contains the number of sectors defined by Set Multiple command.
Write Multiple w/o Erase	CDh	This command is similar to the Write Multiple command, except that an implied erase before the write operation is not performed. Note: Before using this command, it is required to erase the respective sectors using the Erase Sectors command
Write Sector(s)	30h (w/ retry) 31h (w/o retry)	This command writes from 1 to 256 sectors as specified in the Sector Count register. A sector count of zero requests 256 sectors. The transfer begins at the sector specified in the Sector Number register.
Write Sector(s) w/o Erase	38h	This command is similar to the Write Sector(s) command, except that an implied erase before the write operation is not performed. Note: Before using this command, it is required to erase the respective sectors using the Erase Sectors command.
Write Verify	3Ch	This command is similar to the Write Sector(s) command except each sector is verified immediately after being written.

7.0 Revision History

Revision	Date	Description
-101	11/17/06	Product release.
-102	12/14/06	ID file Serial Number, Firmware Revision, and Model Number corrected in table.
-103	1/16/07	Logo updated. Disclaimer updated. Contact Information added.
-104	2/23/07	Serial number revision (paper correction only).
-105	2/28/07	CSEL signal description corrected. DC Characteristics corrected.
-106	4/10/07	Shock updated from 1K to 1.5K. Vibration updated from 18 to 20.
-107	8/06/07	Warranty bullet removed from features column on page 1
-108	8/08/07	Dimensions of housed FDM added. Showpiece photo on page 1 updated.
-109	9/19/07	General Description text updated.
-110	11/12/07	Layout updated for consistency and easier editing. Disclaimer notice reformatted with headings.
-111	3/7/08	Contact information on last page updated.
-112	4/2/08	STEC China address on last page updated.

DISCLAIMER OF LIABILITY

STEC™ Inc. reserves the right to make changes to specifications and product descriptions such as but not limited to numbers, parameters and other technical information contained herein without notice. Please contact the STEC™ Inc. sales office to obtain the latest specifications. STEC™ Inc. grants no warranty with respect to this datasheet, neither explicit or implied, and is not liable for direct or indirect damages. Some states do not grant the exclusion of incidental damages and as such this statement may not be valid in such states. The provisions of the datasheet do not convey to the purchaser of the device any license under any patent rights or other intellectual property rights of STEC Inc. or others.

EXPORT ADMINISTRATION REGULATIONS

The information provided may be subject to United States Export Controls. Such information should not be downloaded or exported (i), into (or to a national or resident of) Cuba, Iraq, Libya, North Korea, Iran, Syria, or any other country to which the United States has embargoed goods; or given to (ii), anyone on the United States Treasury Department's list of Specially Designated Nationals or the U.S. Commerce Department's Table of Deny Orders. By using the information, you represent and warrant that you are not located in, under the control of, or a national or resident of any such country or on any such list.

COPYRIGHT NOTICE

Copyright © 2007 by STEC™ Inc. All rights reserved. Information contained in this document, including but not limited to any instructions, descriptions and product specifications, is considered proprietary and confidential to STEC™, Inc. and shall not be modified, used, copied, reproduced or disclosed in whole or in part, in any form or by any means, electronic or mechanical, for any purpose, without the written consent of STEC™ Inc

Worldwide Headquarters

STEC, Inc.
3001 Daimler Street
Santa Ana, California 92705 USA
Tel: (949) 476-1180
Fax: (949) 476-1209
www.stec-inc.com/

STEC Europe

Donau-City-Strasse 1
1220 Vienna, Austria
Tel: +43 1 263 38 08
Fax: +43 1 263 37 65
www.stec-inc.com/

STEC Japan

Arents Daikanyama 114
11-1 Hachiyama-cho
Shibuya-ku, Tokyo
150-0035 Japan
Tel: +81(0) 3-5428-2231
Tel: +81(0) 3-5489-0230
www.stec-inc.jp/

STEC Malaysia

STEC Techology Sdn Bhd
Plot 107 Bayan Lepas Industrial Park
Phase 4, 11900 Penang, Malaysia
Tel: +60 (4)-6198888
www.stec-inc.com/

STEC China

RM1805, 18F Bund Centre
222 Yan An Rd East
HuangPu District
Shanghai, 200002.
P R. China
Tel: +86 21 6132 3892 * 629
Fax: +86 21 6335 1336
www.stechina.cn/

