

FEATURES

- Versatile analog signal conditioning circuitry**
- On-board reference, crystal oscillator and buffers**
- 16-bit Parallel Buffered Outputs**
- Ideal for DSP and data acquisition card interfaces**
- Analog and digital prototyping area for breadboarding the target system**
- Stand-alone operation or Eval control board compatibility**
- PC software for control and data analysis**
- LabVIEW¹ driver to develop custom application**

GENERAL DESCRIPTION

The EVAL-AD768x/AD769x/AD794xCB is an evaluation board for the AD768x/AD769x/AD794x high resolution ADC (see the Ordering Guide at the end of this document for a product list).

The AD768x/AD769x/AD794x evaluation board is designed to demonstrate the ADC's performance and to provide an easy to understand interface for a variety of system applications. A full

description of the AD768x/AD769x/AD794x is available in the Analog Devices AD768x/AD769x/AD794x data sheet and should be consulted when utilizing this evaluation board.

The EVAL-AD768x/AD769x/AD794xCB is ideal for use with either Analog Devices EVAL-CONTROL BRD2/BRD3 (EVAL-CONTROL BRDx) to run the Analog devices evaluation software and to develop a specific application using LabVIEW, or as a stand-alone evaluation board.

The EVAL-CONTROL BRDx is sold separately from the EVAL-AD768x/AD769x/AD794xCB, is required to run the evaluation software, is not required in stand alone mode and can be reused with many Analog Devices ADCs.

¹ Labview is a trademark of National Instruments.

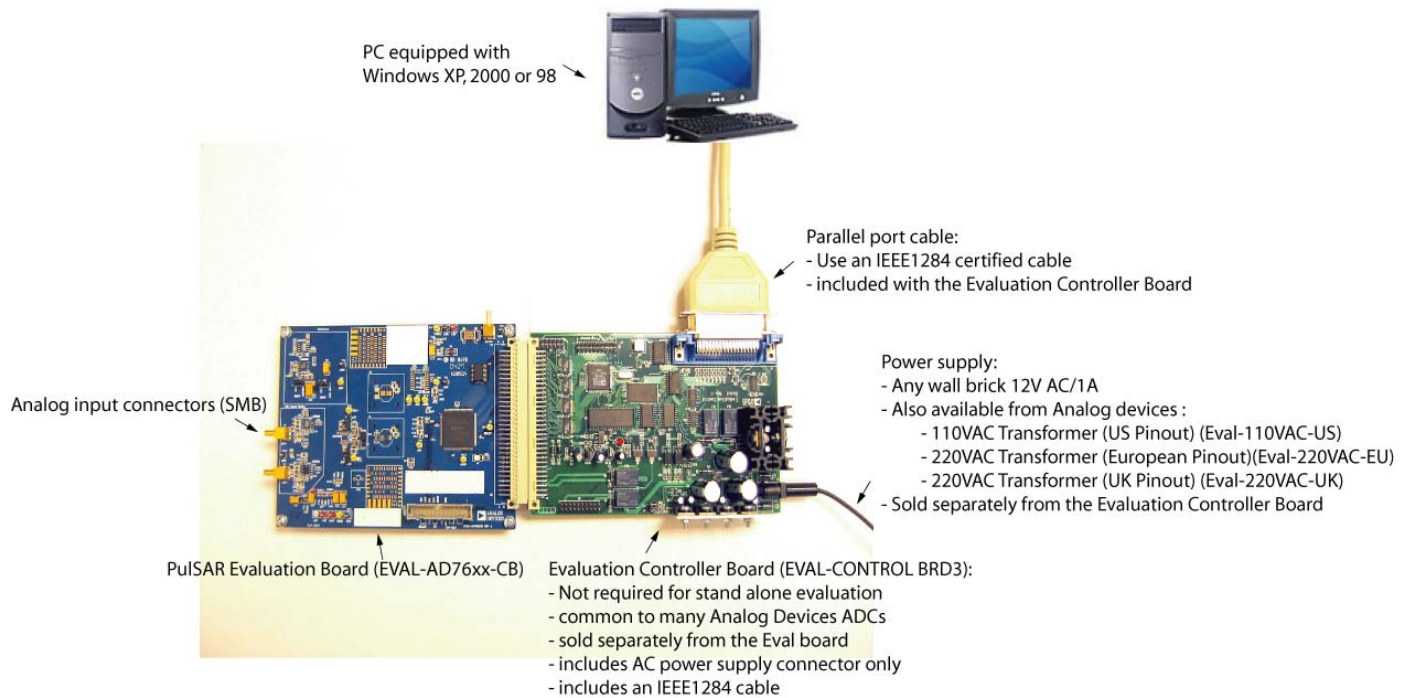

Figure 1.

Rev. Pr F

Information furnished by Analog Devices is believed to be accurate and reliable. However, no responsibility is assumed by Analog Devices for its use, nor for any infringements of patents or other rights of third parties that may result from its use. Specifications subject to change without notice. No license is granted by implication or otherwise under any patent or patent rights of Analog Devices. Trademarks and registered trademarks are the property of their respective owners.

One Technology Way, P.O. Box 9106, Norwood, MA 02062-9106, U.S.A.
Tel: 781.329.4700 www.analog.com
Fax: 781.326.8703 © 2006 Analog Devices, Inc. All rights reserved.

TABLE OF CONTENTS

| | | | |
|--|---|---|----|
| Detailed Description | 3 | Use as a Standalone Evaluation Board..... | 4 |
| Using the EVAL-AD768x/AD769x/AD794xCB Software | 3 | Ordering Guide | 18 |
| Testing Methods | 4 | ESD Caution..... | 18 |

REVISION HISTORY

02/06—PrF Version

05/05—PrE Version

DETAILED Description

The EVAL-AD768x/AD769x/AD794xCB includes a 5 V ultrahigh precision reference ([ADR435](#)), and a signal conditioning circuit with two opamps ([ADA4841](#)) and digital logic. The board interfaces with a 96-way connector for the EVAL-CONTROL BRDx and a 26-pin IDC connector for the serial output interface.

The EVAL-AD768x/AD769x/AD794xCB is a four-layer board carefully laid out and tested to demonstrate the specific high accuracy performance of the AD768x/AD769x/AD794x. Figure 2 through Figure 5 show the schematics of the evaluation board. The layouts of the board are shown in the following figures:

Figure 6: Top-Side Silk-Screen

Figure 7: Top-Side Layer

Figure 8: Ground Layer

Figure 9: Shield Layer

Figure 10: Bottom-Side Layer

Figure 11: Bottom-Side Silk-Screen

The EVAL-AD768x/AD769x/AD794xCB has a flexible design that enables the user to choose among many different board configurations. A description of each selectable jumper is listed in Table 1, and the available test points are listed in Table 2.

The EVAL-AD768x/AD769x/AD794xCB is configured in the factory with the front-end amplifiers U6 and U7 set to a gain of 1. The board is set to be powered through the EVAL-CONTROL BRDx.

Buffered conversion data is available at the output parallel bus BD on U3 and on the 96-pin connector P3 and is valid during the falling edge of BBUSY on P3. Activity of the ADC turns on the on-board LED

Power Supplies and Grounding

The EVAL-AD768x/AD769x/AD794xCB has two power supply blocks:

-SJ2 for the analog section including the AD768x/AD769x/AD794x, the signal conditioning and the reference voltage circuitry.

-SJ1 for the digital interface circuitry and the digital section of the ADC.

These offer flexibility to evaluate the ADC and the surrounding circuitry with any power supply combination.

Analog Input Ranges and Multiplexing

The analog front-end amplifier circuitry U6 and U7 allows flexible configuration changes such as positive or negative gain,

input range scaling, filtering, addition of a DC component, use of different op-amp and supplies.

The factory configuration of the analog input of U6 and U7 is set at midscale. This allows a transition noise test without any other equipment. An FFT test can be done by applying a very low distortion AC source.

As an option, an [ADG739](#) multiplexer can be used in front of the ADC to demonstrate performances for multichannel applications.

A second ADC can be mounted on the board to demonstrate the daisy-chain feature.

Using the EVAL-AD768x/AD769x/AD794xCB Software

This configuration requires to use the EVAL-CONTROL BRDx to interface the EVAL-AD768x/AD769x/AD794xCB with the PC.

Software Description

The EVAL-AD768x/AD769x/AD794xCB comes with software for analyzing the AD768x/AD769x/AD794x. One can perform a histogram to determine code transition noise, and Fast Fourier Transforms (FFT's) to determine the Signal-to-Noise Ratio (SNR), Signal-to-Noise-plus-Distortion (SINAD) and Total-Harmonic-Distortion (THD). The AC performances can also been evaluated after digital filtering (averaging) with enhanced resolution (up to 32 bits). The front-end PC software has four screens:

Figure 12 is the Setup Screen where sample rate, number of samples are selected.

Figure 13 is the Histogram Screen, which allows the code distribution for DC input and computes the mean and standard deviation.

Figure 14 is the FFT Screen, which performs an FFT on the captured data, computes SNR, SINAD and THD.

Figure 15 is the time domain representation of the output. When the on-board conversion (CNV) generation is used, a synchronous FFT can be achieved by synchronizing an external AC generator with the 10MHz Fsync signal (J4) a 10 MHz signal, exact division of master clock (MCLK).

Figure 16 is the FFT Screen when averaging is used.

Software Installation (executable)

There is no need to have LabVIEW installed to run the executable.

Double-click on Setup.exe in the LabVIEW exe folder from the CD-ROM shipped with EVAL-AD768x/AD769x/AD794xCB (do not use the CD shipped with the EVAL-CONTROL BRDx)

and follow the installation instructions.

Developing your own application using LabVIEW

You need LabVIEW 7.1 or above to do this. Install the executable first, copy the folder LabVIEW VI and run the ADC vi example.vi

Testing Methods

Histogram

To perform a histogram test, apply a DC signal to the input. It is advised to filter the signal to make the DC Source noise compatible with that of the ADC. C26 and C41 provide this filtering.

AC Testing

To perform an AC test, apply a sinusoidal signal to the evaluation board. Low distortion, better than 100dB, is required to allow true evaluation of the part. One possibility is to filter the input signal from the AC source. There is no suggested band-pass filter but consideration should be taken in the choice.

Decimated Testing (Averaging)

This test can be run with a shorted input to evaluate dynamic range or as the AC test.

Setup Requirements

- EVAL-CONTROL BRD_x (ADSP2189)
- Evaluation board
- Power supply (AC 12V/1A source could be bought from Analog Devices – sold separately from the EVAL-CONTROL BRD_x)
- Parallel port cable (provided with the evaluation control board)
- AC source (low distortion)
- DC source (low noise)
- Band-pass filter (value based on the signal frequency, low distortion)

Use as a Standalone Evaluation Board

You have the option of using the EVAL-AD768x/AD769x/AD794xCB as a stand-alone evaluation board. This method does not require the EVAL-CONTROL BRD_x, nor does it require use of the accompanied software. The ADC serial interface signals are available on P1 (26-pin connector).

Table 1. Jumper Description

| Jumper Designation | Default position with the control board (Factory settings) | Function |
|--------------------|---|--|
| JP1 | AMP+ | Selection of the IN+ analog signal of U1 and U8. Position AMP+ = the signal present on JP13 is selected. Position not in AMP+ = optional multiplexer output, DB, is used. |
| JP2 | AMP- | Selection of JP3 source. Position AMP- = the signal present on JP25 is selected. Position not in AMP- = optional multiplexer output, DA, is used. |
| JP3 | Unip or Diff (see text) | Selection of the IN- analog signal of U1. Position Unip = single-ended ADC: AD7683, AD7685, AD7694, AD7942 and AD7946. Position Diff = true differential ADC: AD7684, AD7687, AD7688, AD7690, AD7691, and AD7693. |
| JP4 | ADR43X | Selection of the reference voltage. Position ADR43X = on board 5V reference voltage is used. Position VDD = the ADC reference is coming from the VDD supply. |
| JP5 | BUF | Selection of the reference voltage. Position NO BUF = refence present on JP4 (ADR43X or VDD) is selected Position BUF = buffered reference present on JP4 (ADR43X or VDD) is selected. This buffer (AD8032) can help to filter the VDD when used as the reference voltage. |
| JP6 | - 5 V | Selection for negative supply, VDRV. |
| JP7 | 7 V | Selection for positive supply, VDRV+. |
| JP8 | 12 V | Selection for reference circuit supply, VREF. |
| JP9 | VDD | Selection for digital output interface voltage, VIO. |
| JP10 | +VA | Selection for ADC, U1 and U8 supply VDD. |
| JP11 | 3.3 V | Selection for FPGA output interface voltage VIO. Must be set at VIO or 3.3V which ever is the lowest. |
| JP13 | BUF+ | Selection of JP1 source BUF+ = U6 amplifier output. SMB+ = direct input from J1, AIN+ (SMB plug). DIF+ = optional differential amplifier + output. |
| JP25 | BUF- | Selection of JP2 source BUF- = U7 amplifier output. SMB- = direct input from J2, AIN-(SMB plug). DIF- = optional differential amplifier - output. |

Table 2. EVAL-AD768x/AD769x/AD794xCB Test Points

| Test Point | Mnemonic | Available Signal |
|------------|----------|-------------------------|
| TP1 | GND | Ground |
| TP2 | GND | Ground |
| TP3 | SIG+ | ADC Analog input IN+ |
| TP4 | GND | Ground |
| TP5 | REF | ADC Reference input |
| TP6 | SDI | ADC (U1) SDI signal |
| TP7 | CNV | ADC CNV signal |
| TP8 | SCK | ADC SCK signal |
| TP9 | SDO | ADC (U1) SDO signal |
| TP10 | SDO2 | ADC (U8) SDO signal |
| TP11 | BBUSY | Parallel ADC data valid |
| TP12 | GND | Ground |
| TP13 | SIG- | ADC Analog input |

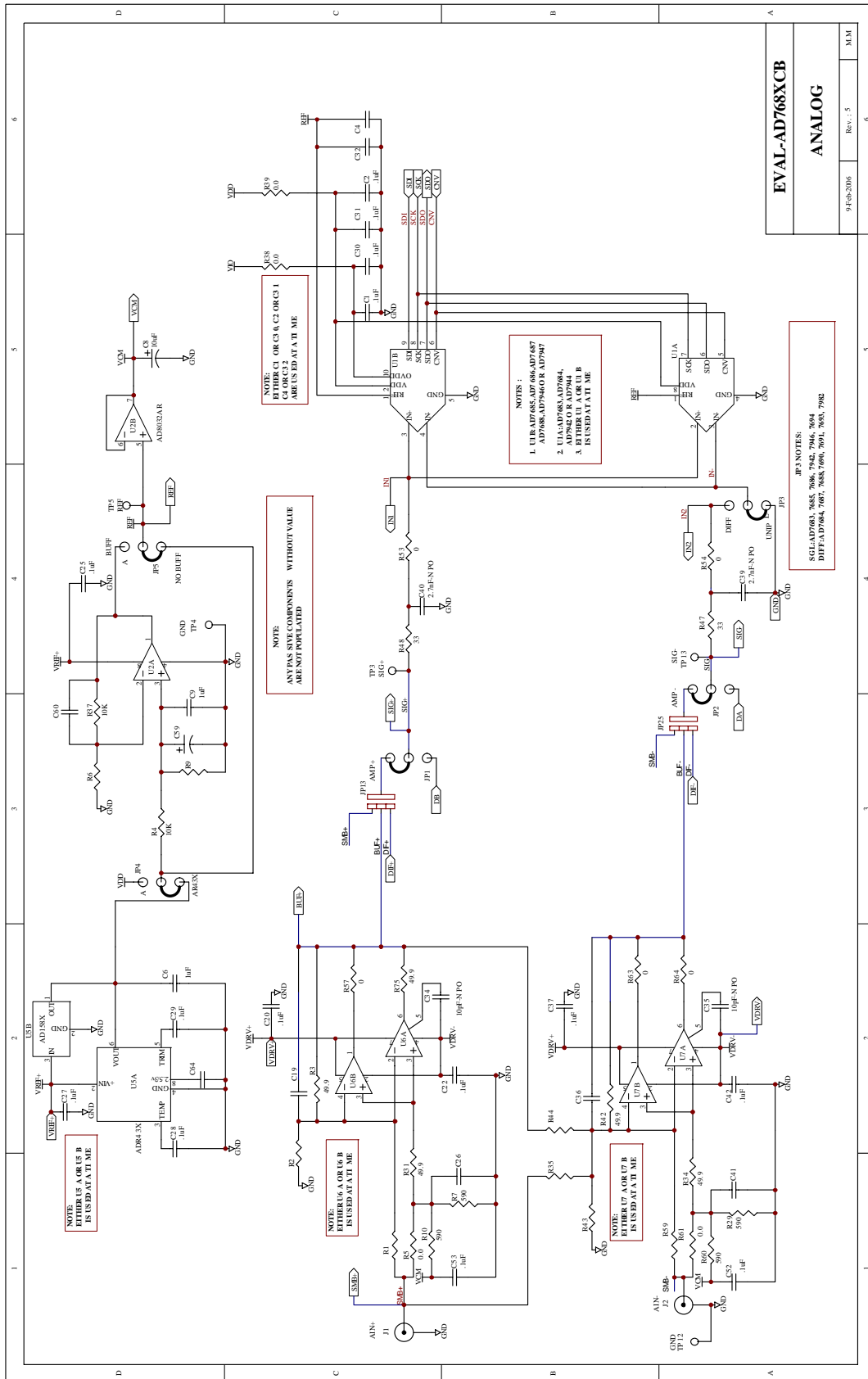

| | |
|-----------------------|----------|
| EVAL-AD768X CB | |
| ANALOG | |
| 9 Feb 2006 | Rev. : 5 |
| M.M | 6 |

Figure 2. Schematic (Analog section)

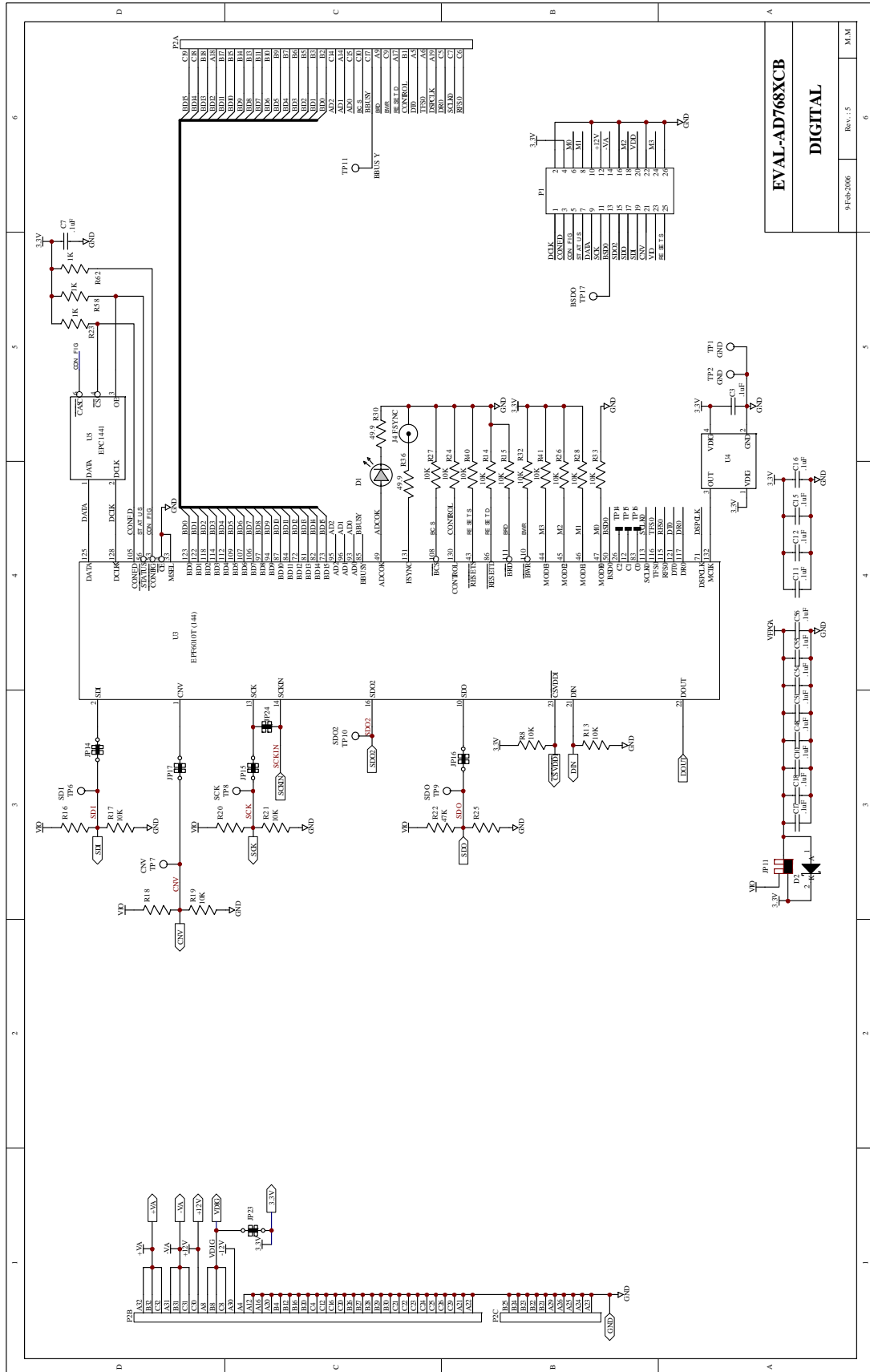

Figure 3. Schematic (Digital Section)

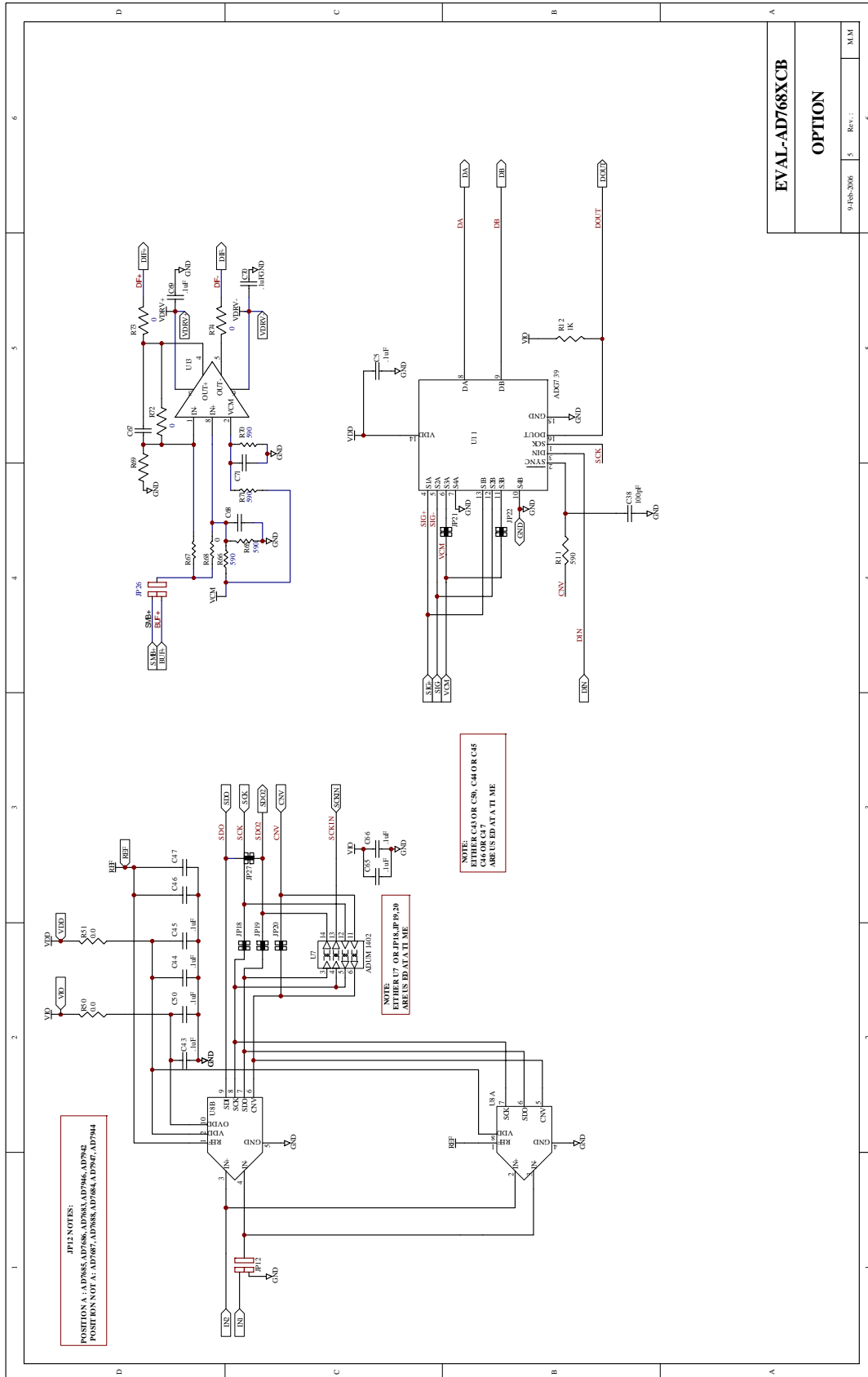

Figure 4. Schematic (Option Section)

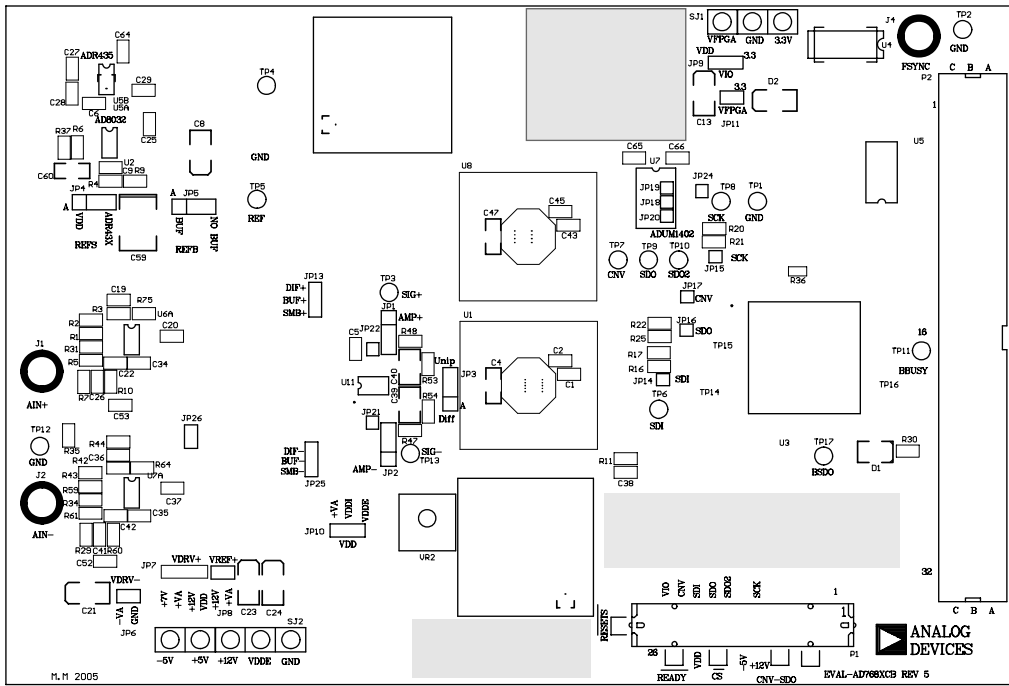

Figure 6. Top-Side Silk-Screen (Not to Scale).

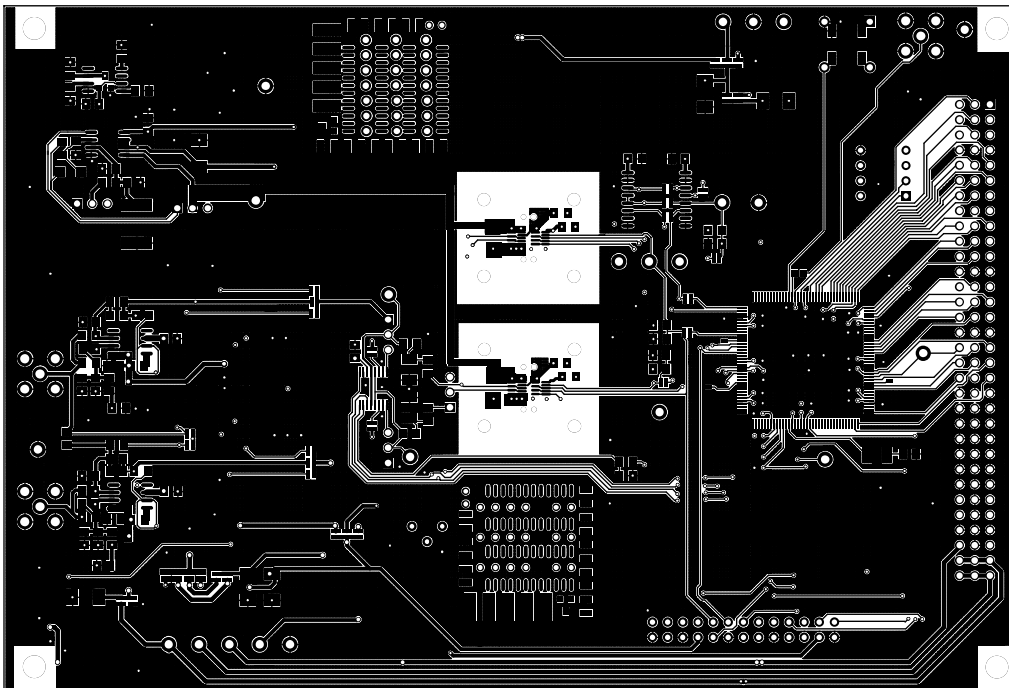

Figure 7. Top-Side (Not to Scale).

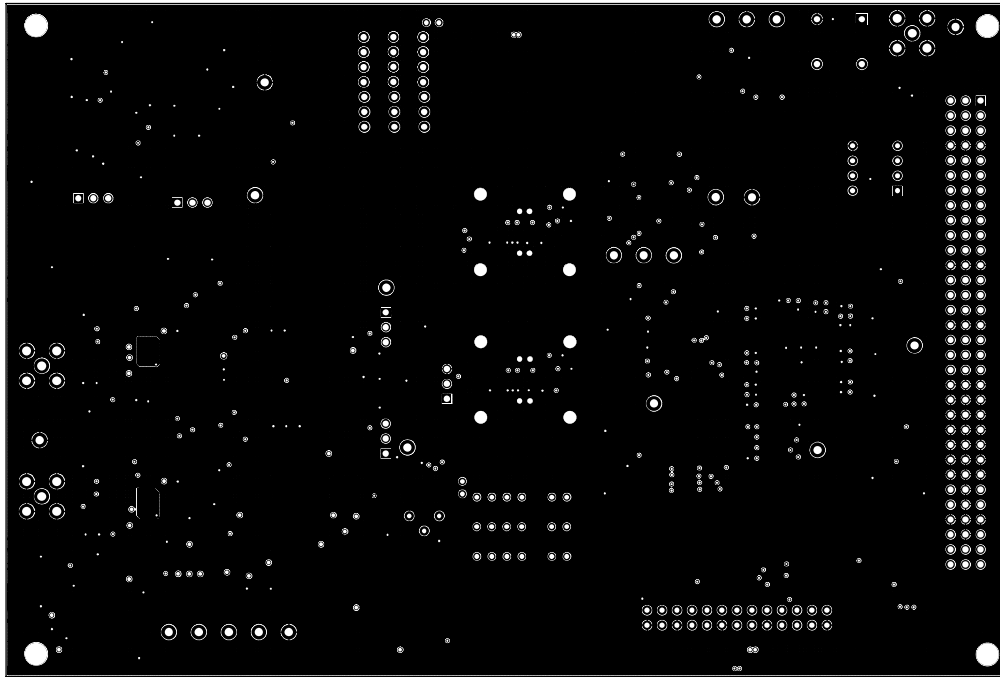

Figure 8. Ground Layer (Not to Scale).

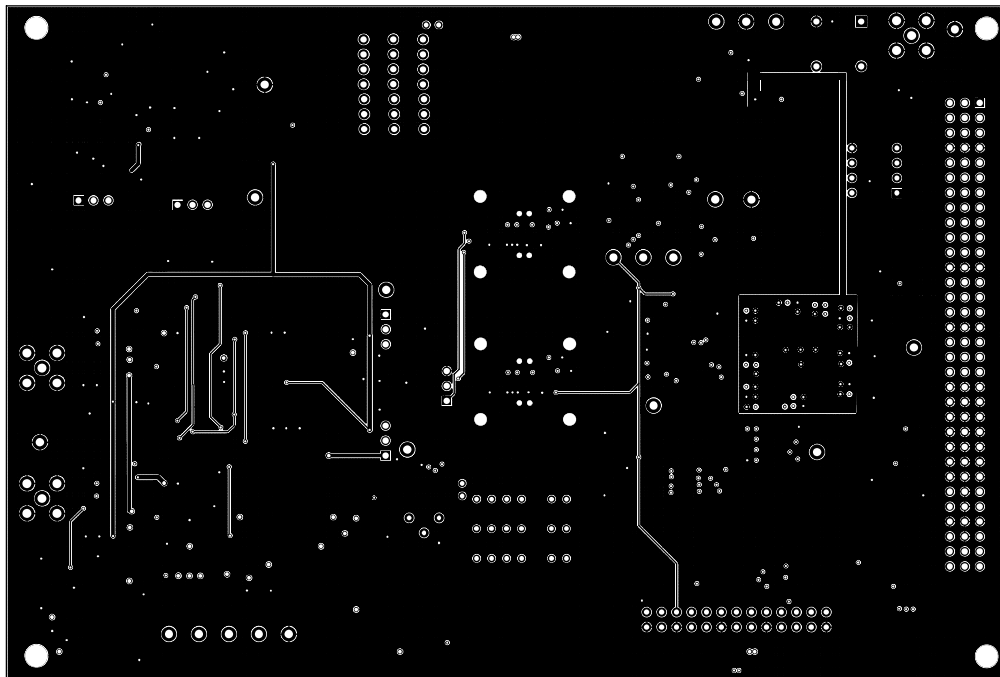
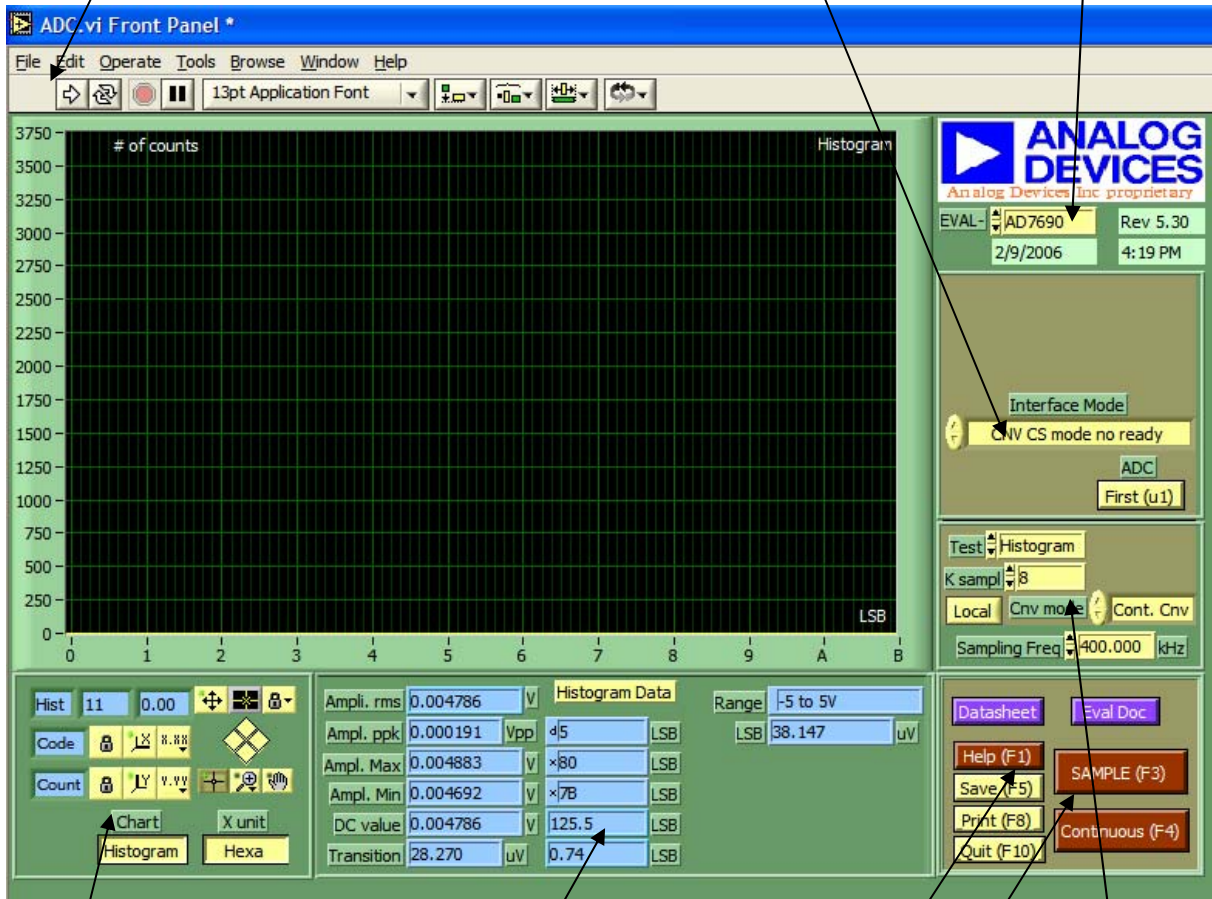

Figure 9. Shield Layer (Not to Scale).

1) The Run button starts the software. This button must be pressed first.

2) The part under evaluation is chosen from this menu. The device must be selected second.

3) Input configurations are chosen here. The available choices are: Interface Mode, ADC (use help (F1) to see the description of each parameter).



This is the performance window.

These controls are for locking and resetting the display axis to the data minimum and maximum values.

6) These gives direct access to datasheets and evaluation documentation.

5) This window allows the samples to be taken once (F3) or continuous (F4). Also selects: Help screen, Save data to Excel (F5), Print (F8) and Quit (F10). The Help menu shows a description of the functionality of the chosen command.

4) This window is used to select the test type, number of samples (in K), and conversion mode (continuous or burst). For the test type choose from either:

- Histogram test
- AC Test
- Decimated AC Test

Figure 12. Setup Screen

The results are displayed in this chart. Also, the cursor (yellow) can be dragged to a desired location where the X-axis values and the Y-axis value will be displayed.

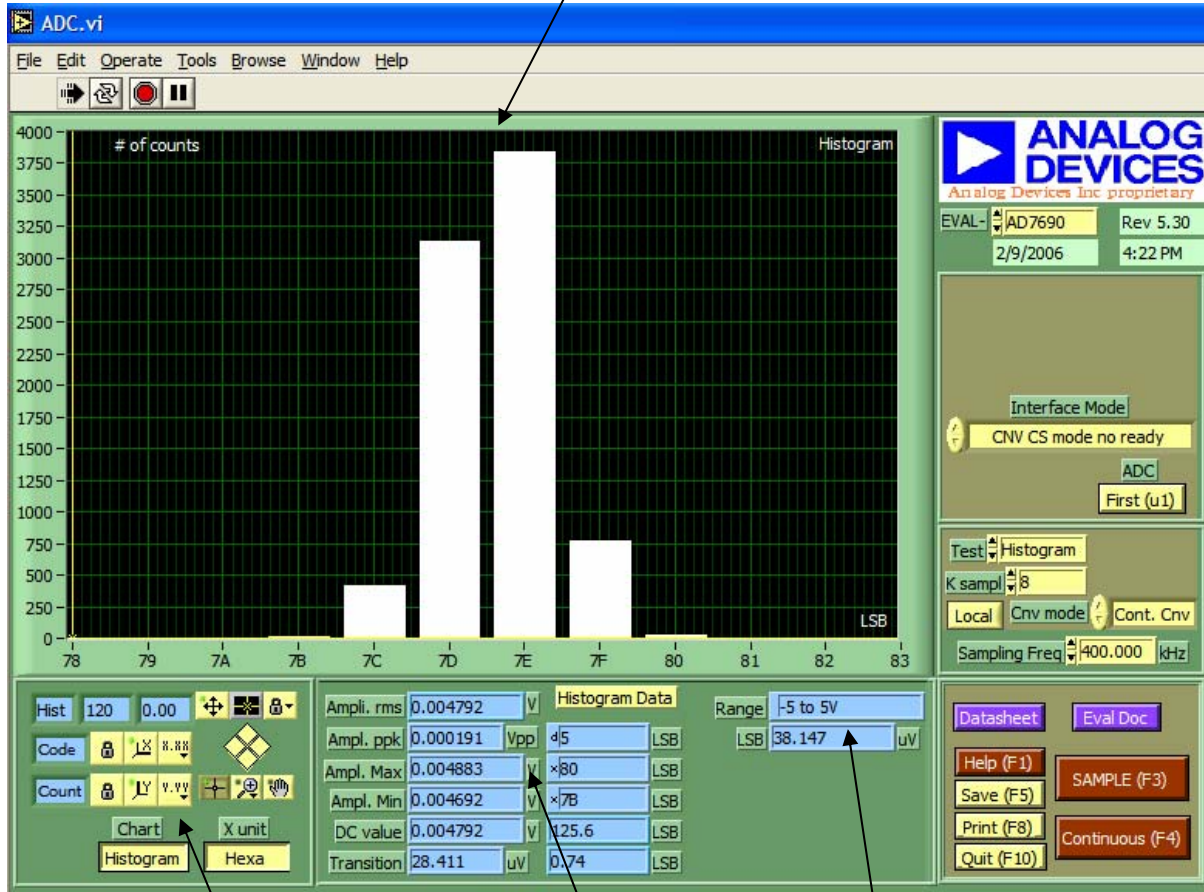

These control the choice of chart type and X-units. Chart type selection of Histogram or Time and X-units of hexadecimal or Volts.

This window shows the ADC range and LSB value in Volts.

Different measurements are displayed here. The DC value, Transition Noise and other values

Figure 13. Histogram Screen

The results are displayed in this chart. Also, the cursor (yellow) can be dragged it to a desired location where the X-axis values and the Y-axis value will be displayed.

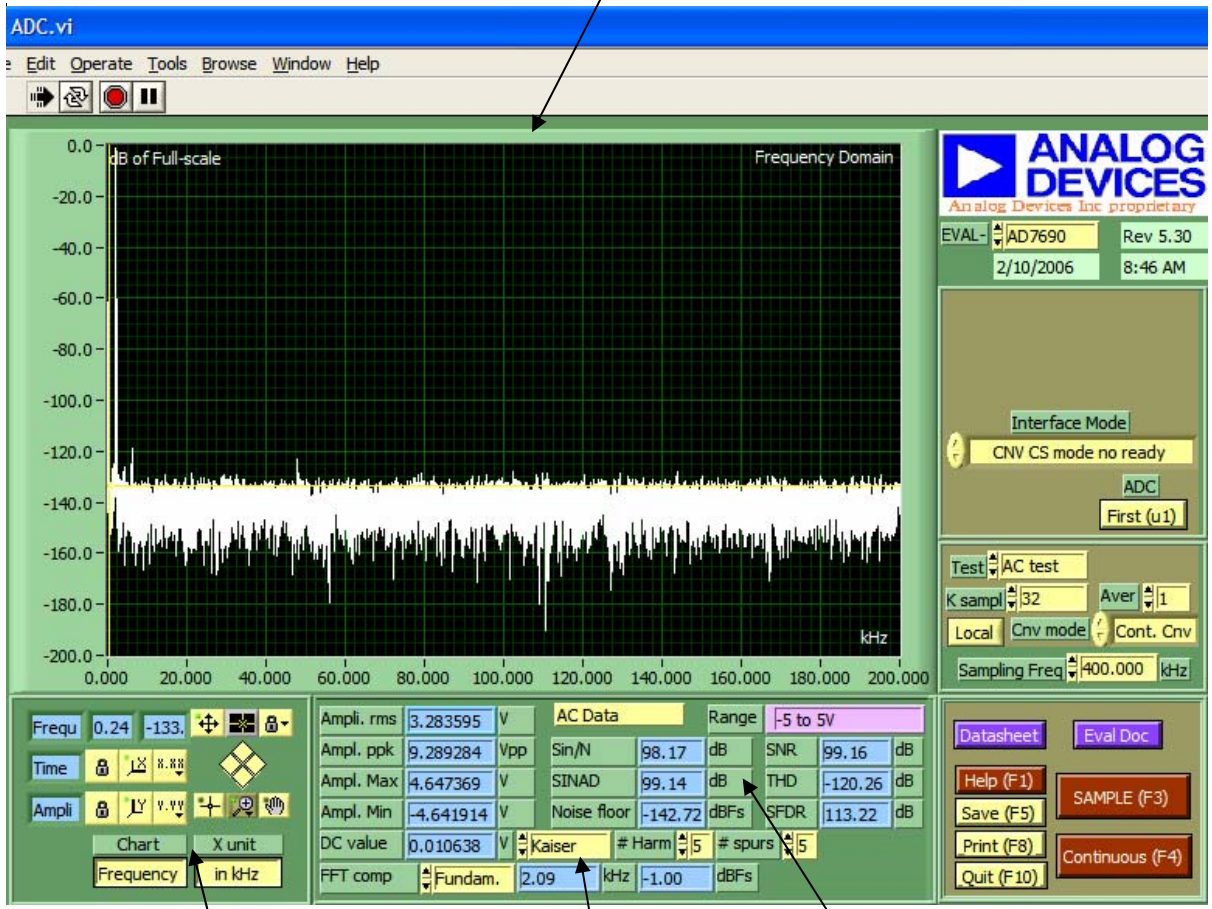

These control the chart type choice of Frequency domain or Time domain and X axis units.

AC test results are displayed here. Also the choice of viewing the amplitude of a certain FFT component can be selected from the FFT component menu.

Choice of either a Kaiser window or a Blackmann-Harris window from the is menu.

Figure 14. FFT Screen

The AC test can also be displayed in the Time Domain as shown below.

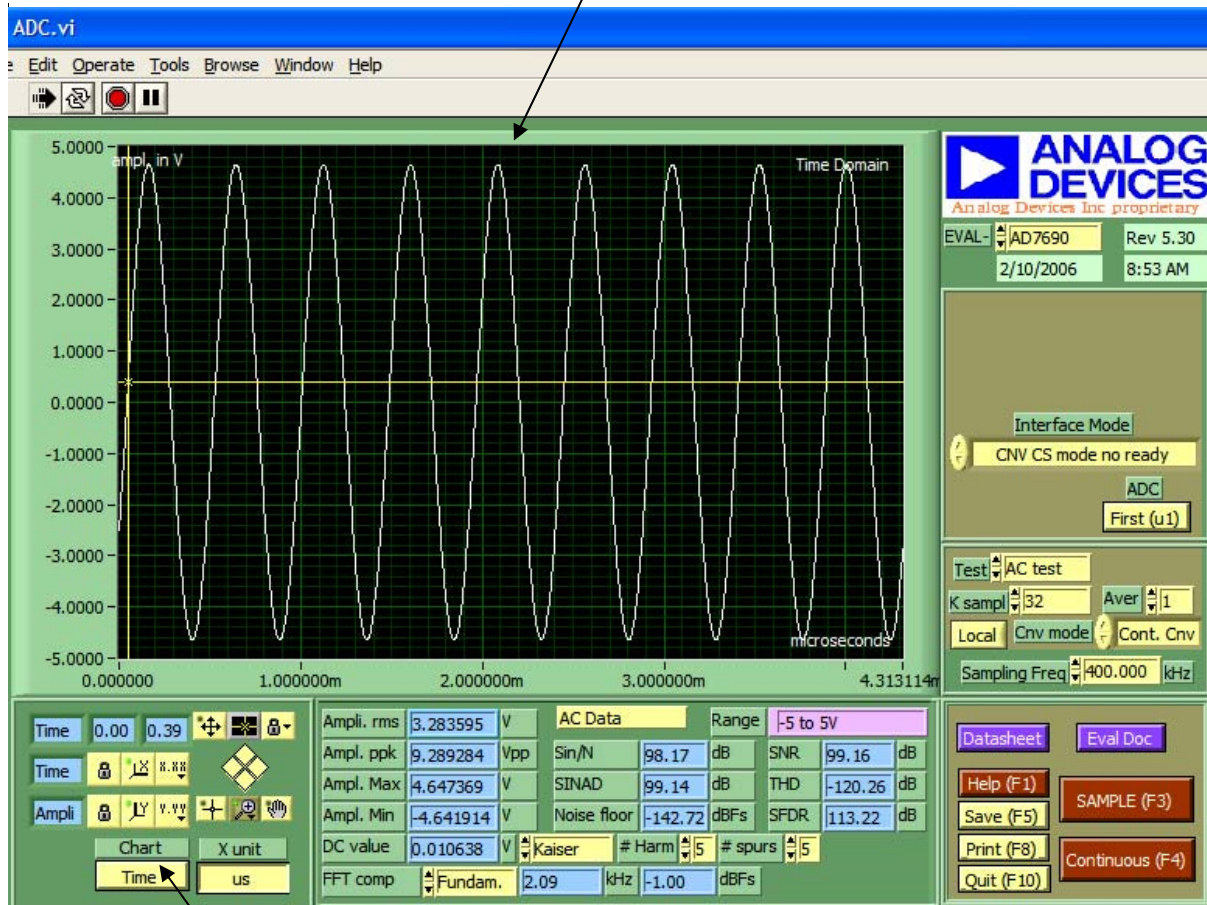

To view the Time domain output, select Time in this menu.

Figure 15. Time-Domain Screen

The results are displayed in this chart. Also, the cursor (yellow) can be dragged it to a desired location where the X-axis values and the Y-axis value will be displayed.

The decimation ratio (Dratio) and number of Ksamples are entered here.

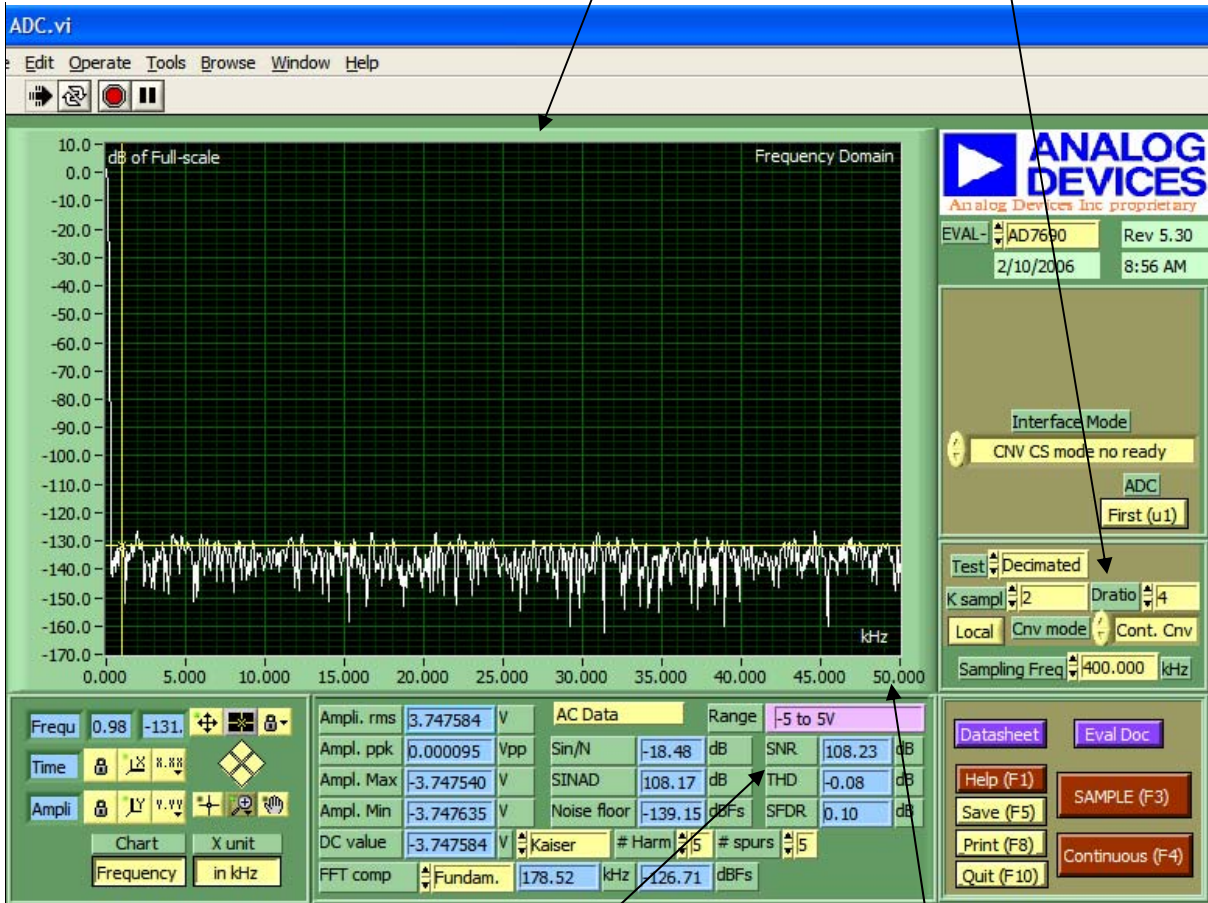

AC test results with decimated averaging are shown here. The SNR indicator also represents the dynamic range when no signal is present.

The Nyquist frequency is displayed here as:

$$F_{\text{NYQUIST}} = \frac{F_{\text{SAMPLE}}}{2 * D_{\text{RATIO}}}$$

Figure 16. Decimated (Averaging) Screen

The term AD768x/AD769x/AD794x is used in this document to represent all the ADCs listed in the ordering guide.

ORDERING GUIDE

| Evaluation Board Model | Product |
|------------------------|--|
| EVAL-AD7683CB | AD7683BRM |
| EVAL-AD7684CB | AD7684BRM |
| EVAL-AD7685CB | AD7685CRM |
| EVAL-AD7686CB | AD7686CRM |
| EVAL-AD7687CB | AD7687BRM |
| EVAL-AD7688CB | AD7688BRM |
| EVAL-AD7690CB | AD7690BRM |
| EVAL-AD7691CB | AD7691BRM |
| EVAL-AD7693CB | AD7693BRM |
| EVAL-AD7694CB | AD7694BRM |
| EVAL-AD7942CB | AD7942BRM |
| EVAL-AD7946CB | AD7946BRM |
| EVAL-CONTROL BRD2 | Controller Board (not in production anymore) |
| EVAL-CONTROL BRD3 | Controller Board |

ESD CAUTION

ESD (electrostatic discharge) sensitive device. Electrostatic charges as high as 4000 V readily accumulate on the human body and test equipment and can discharge without detection. Although this product features proprietary ESD protection circuitry, permanent damage may occur on devices subjected to high energy electrostatic discharges. Therefore, proper ESD precautions are recommended to avoid performance degradation or loss of functionality.

