

# T Series Subminiature Toggle Switches

## Features/Benefits

- Compact size—small footprint
- Single and double pole models
- PC and panel mount options available
- RoHS compliant models available

## Typical Applications

- Hand-held telecommunications
- Instrumentation
- Medical equipment



  
Models Available

## Specifications

**CONTACT RATING:** B contact material: 0.4 VA max. @ 20 V AC or DC max. Q contact material (TX01 models): 3 AMPS @ 120 V AC or 28 V DC. All other models: 2 AMPS @ 120 V AC or 28 V DC. See page F-42 for additional ratings.

**ELECTRICAL LIFE:** TX01 models: 60,000 make-and-break cycles at full load. All other models: 30,000 cycles.

**CONTACT RESISTANCE:** Below 20 m Ω typ. initial @ 2-4 V DC, 100 mA, for both silver and gold plated contacts.

**INSULATION RESISTANCE:** 10<sup>9</sup> Ω min.

**DIELECTRIC STRENGTH:** 1000 Vrms min. @ sea level.

**OPERATING TEMPERATURE:** -30°C to 85°C.

**SOLDERABILITY:** Per MIL-STD-202F method 208D, or EIA RS-186E method 9 (1 hour steam aging).

**NOTE:** Any models supplied with P, R, Q, B or G contact material are RoHS compliant and compatible.

**NOTE:** Specifications and materials listed above are for switches with standard options. For information on specific and custom switches, consult Customer Service Center.

## Materials

**CASE:** Glass filled nylon 6/6, flame retardant, heat stabilized or diallyl phthalate (DAP), (UL 94V-0) or glass filled nylon 4/6, flame retardant, heat stabilized.

**ACTUATOR:** Brass, chrome plated.

**BUSHING:** Brass, nickel plated.

**HOUSING:** Stainless steel.

**SWITCH SUPPORT:** Brass, matte-tin plated.

**END CONTACTS:** B contact material: Copper alloy, with gold plate over nickel plate. Q contact material: Coin silver, silver plated. See above for additional contact materials.

**CENTER CONTACTS & TERMINALS:** B contact material: Copper alloy, with gold plate over nickel plate. Q contact material: Copper alloy, silver plated. See page F-42 for additional contact materials.

**TERMINAL SEAL:** Epoxy.

**HARDWARE:** Nut & Locking Ring: Brass, nickel plated.  
Lockwasher: Steel, nickel plated. Additional hardware available separately, see Section N.

## Build-A-Switch

To order, simply select desired option from each category and place in the appropriate box. Available options are shown and described on pages F-38 thru F-42. For additional options not shown in catalog, consult Customer Service Center. All models have epoxy terminal seal and are compatible with all "bottom-wash" PCB cleaning methods.

### Switch Function

- T101** SPDT On-None-On
- T102** SPDT Off-None-On
- T103** SPDT On-Off-On
- T105** SPDT Mom.-Off-Mom.
- T107** SPDT On-Off-Mom.
- T108** SPDT On-None-Mom.
- T201** DPDT On-None-On
- T203** DPDT On-Off-On
- T205** DPDT Mom.-Off-Mom.
- T207** DPDT On-Off-Mom.
- T208** DPDT On-None-Mom.
- T211** DPDT On-On-On.

### Actuator

- P3** Flatted, anti-rotation, .490" high
- S** .370" high
- K** Locking lever, round tip
- L1** .620" high
- M1** .220" high
- S1** .410" high
- M** .210" high
- L** .290" high

### Bushing

- H** .220" high, threaded, flat
- H9** .220" high, unthreaded, flat
- CF** Splashproof, .310" high, threaded, flat
- D9** .260" high, unthreaded, keyway
- T** .310" high, threaded, flat
- T9** .310" high, unthreaded, flat
- TD** .260" high, threaded, keyway
- TK** .310" high, threaded, keyway
- Y** .220" high, threaded, keyway
- Y9** .220" high, unthreaded, keyway

### Terminations

- A** Right angle, PC thru-hole
- AV** Vertical right angle, PC thru-hole
- C** PC Thru-hole
- V3** Vertical mount V-bracket
- Z** Solder lug
- W** Wire wrap

### Contact Material

- B** Gold
- P** Gold, matte tin
- Q** Silver
- G** Gold over silver
- R** Gold over silver, matte-tin

### Seal

- E** Epoxy

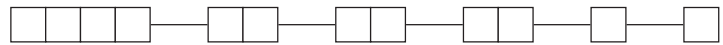

Dimensions are shown: Inches (mm)  
Specifications and dimensions subject to change



# T Series Subminiature Toggle Switches

## SWITCH FUNCTION

NO. POLES	MODEL NO.	SWITCH FUNCTION			CONNECTED TERMINALS			SCHEMATIC
		POS. 1	POS. 2	POS. 3	POS. 1	POS. 2	POS. 3	
SP	T101	ON	NONE	ON	2-3	N/A	2-1	
	T103	ON	OFF	ON	2-3	OPEN	2-1	
	T105	MOM.	OFF	MOM.				
	T107	ON	OFF	MOM.				
	T108	ON	NONE	MOM.	2-3	NA	2-1	
T102	OFF	NONE	ON	OPEN	N/A	3-1		

### SPDT

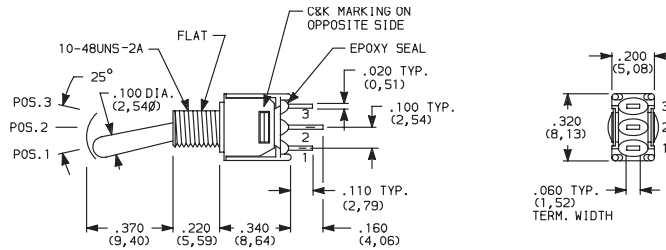

Part number shown: T101SHZQE

NO. POLES	MODEL NO.	SWITCH FUNCTION			CONNECTED TERMINALS			SCHEMATIC
		POS. 1	POS. 2	POS. 3	POS. 1	POS. 2	POS. 3	
DP	T201	ON	NONE	ON	2-3,5-6	N/A	2-1,5-4	
	T203	ON	OFF	ON	2-3,5-6	OPEN	2-1,5-4	
	T205	MOM.	OFF	MOM.				
	T208	ON	NONE	MOM.	2-3,5-6	N/A	2-1,5-4	
	T211*	ON	ON	ON	2-3,5-6	2-3,5-4	2-1,5-4	

### DPDT

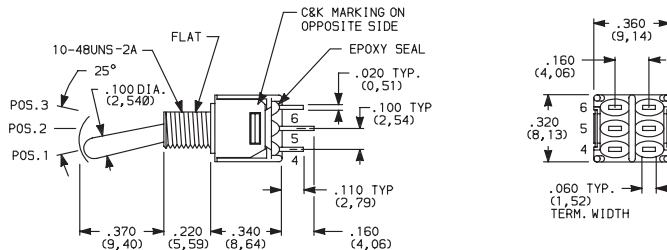

Terminal Nos.  
For Reference Only

Part number shown: T201SHZQE

MOM. = Momentary

All models with all options when ordered with G, L, R or Q contact material.

Toggle



Dimensions are shown: Inches (mm)  
Specifications and dimensions subject to change

[www.ck-components.com](http://www.ck-components.com)

# T Series Subminiature Toggle Switches

## ACTUATOR

**M** .210" HIGH

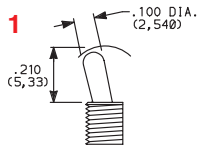

Standard with A, AV or V3 terminations.

**S** .370" HIGH

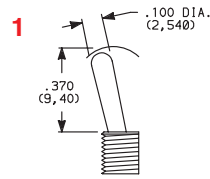

Standard with Z, C or W terminations.

**M1** .220" HIGH  
(with "T" bushing)

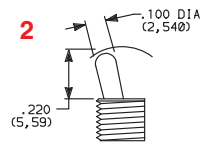

**S1** .410" HIGH  
(with "T" bushing)

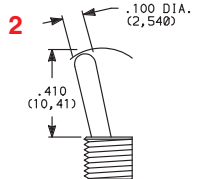

**L** .290" HIGH

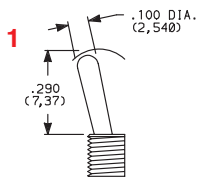

**L1** .620" HIGH

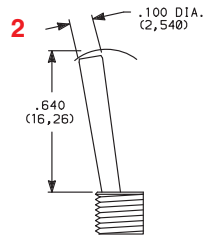

**P3** ANTI-ROTATION, FLATTED,  
.450" HIGH

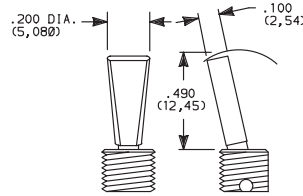

Available with T & T9 bushings only.  
Dress nut part number 709901201  
supplied standard with threaded bushing.

1 Actuator shown with standard H bushing.  
Subtract .040 (1,02) for TD and D9 bushings,  
subtract .090 (2,29) for T, T9, TK, K9 &  
CF bushings.

2 Actuators shown with T, T9, TK & CF bushings,  
add .050 (1,27) for TD and D9 bushings,  
add .090 (2,29) for H, H9, Y & Y9 bushings.  
All actuators have chrome finish (except K).

**K** LOCKING LEVER

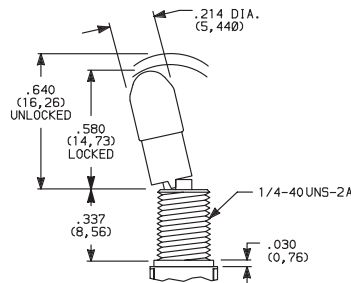

Not available with CF bushing option.

Bushing option code not required. Not available with TX05 & TX07 models.

### Locking Positions



-01 & -02 Models  
2 Position lock



-03 & -11 Models  
3 Position lock



-08 Models  
1 Position lock

K actuators have natural aluminum finish.

Keyway on right side. To prevent accidental actuation, toggles  
must be lifted before being actuated. When released, toggles  
again lock in place. Overtightening mounting nut may cause  
actuator to bind.

## BUSHING

**H** .220" HIGH THREADED, FLAT

**H9** .220" HIGH UNTHREADED, FLAT

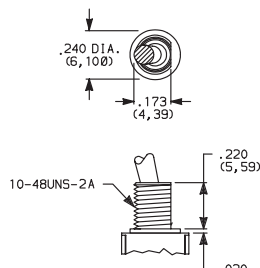

H standard with C, W & Z terminations.  
H9 standard with A, AV & V3 terminations.

**Y** .220" HIGH THREADED, KEYWAY

**Y9** .220" HIGH UNTHREADED, KEYWAY

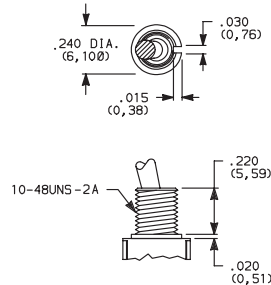

**T** .310" HIGH THREADED, FLAT

**T9** .310" HIGH UNTHREADED, FLAT

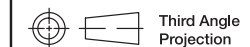
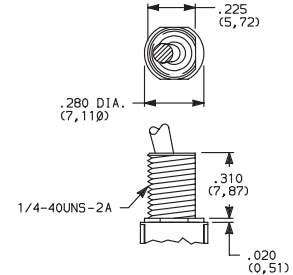

Third Angle  
Projection

Dimensions are shown: Inches (mm)  
Specifications and dimensions subject to change

**C&K**



**F**

Toggle

# T Series Subminiature Toggle Switches

## BUSHING

**TK** .310" HIGH THREADED, KEYWAY

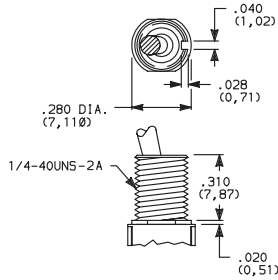

**TD** .260" HIGH THREADED, KEYWAY

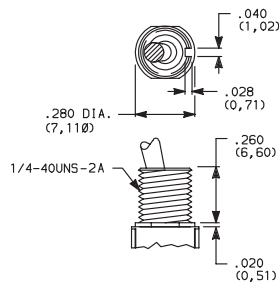

**D9** .260" HIGH UNTHREADED, KEYWAY

**CF** SPLASHPROOF, .310" HIGH THREADED, FLAT

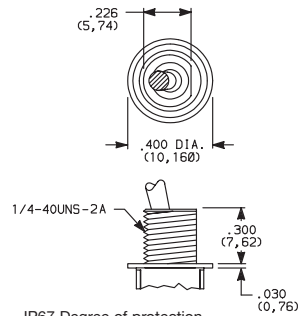

IP67 Degree of protection.  
Internal o-ring actuator seal and external bushing seal washer standard.

Not available with K locking lever option.

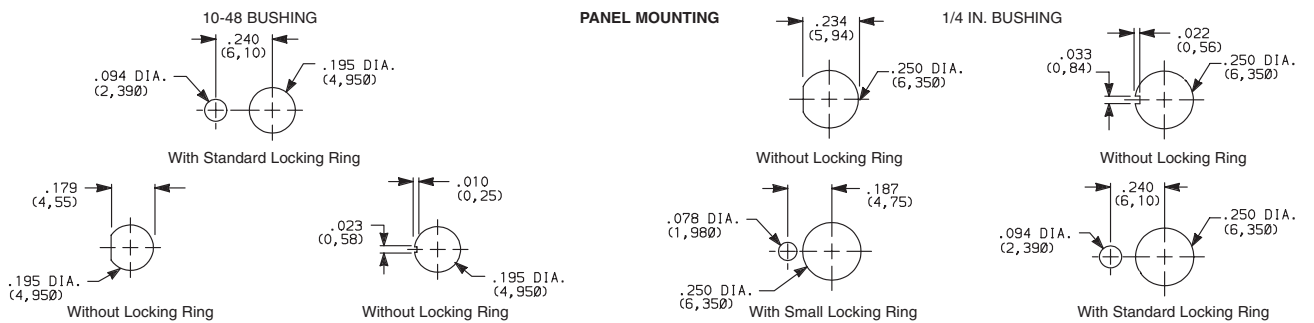

## TERMINATIONS

**Z** SOLDER LUG

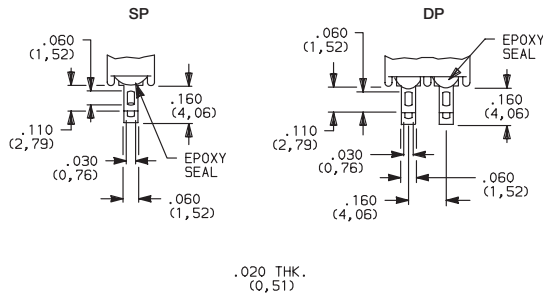

Not available with P or R contact materials.

**C** PC THRU-HOLE

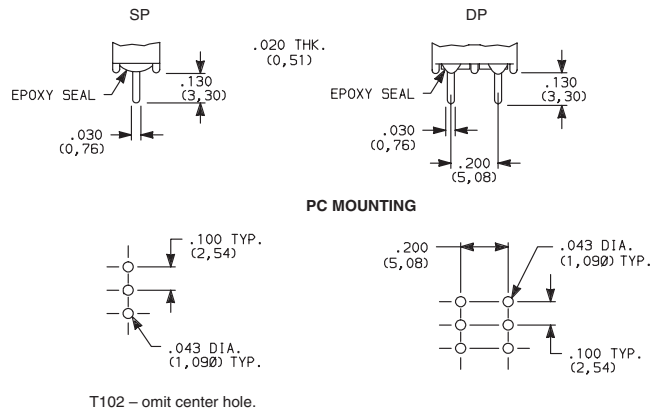

T102 - omit center hole.

**W** WIRE WRAP

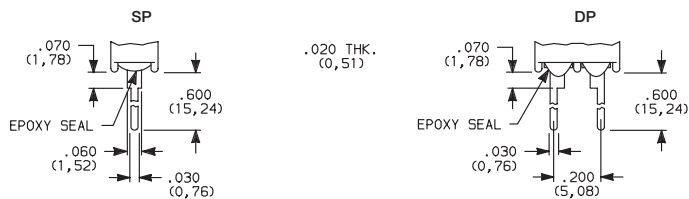

**F**

Toggle



Third Angle  
Projection

Dimensions are shown: Inches (mm)  
Specifications and dimensions subject to change

**C&K**

# T Series Subminiature Toggle Switches

## TERMINATIONS

### A RIGHT ANGLE, PC THRU-HOLE

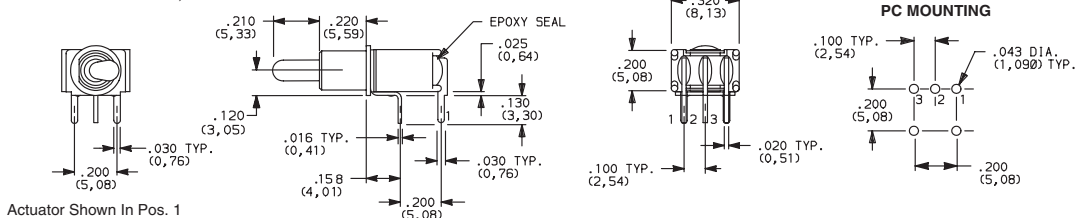

### A RIGHT ANGLE, PC THRU-HOLE

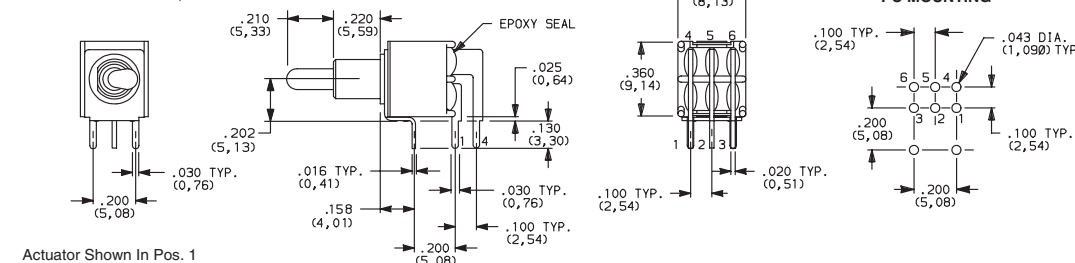

### AV VERTICAL RIGHT ANGLE, PC THRU-HOLE

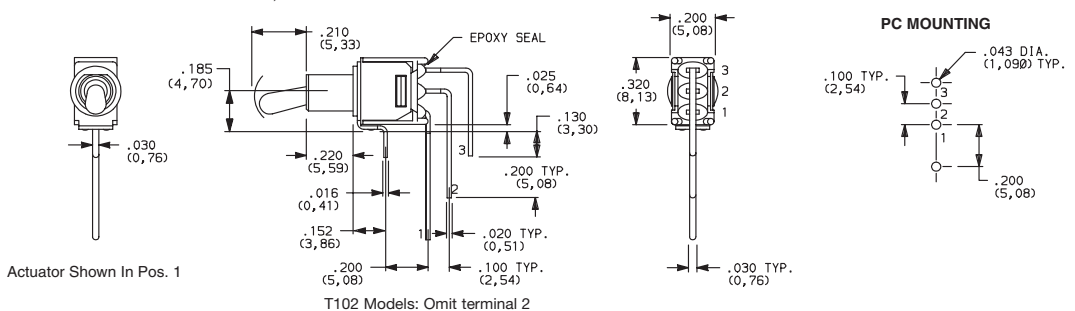

**NOTE:** Terminal bend radii and lead-in manufacturing option.

### AV VERTICAL RIGHT ANGLE, PC THRU-HOLE

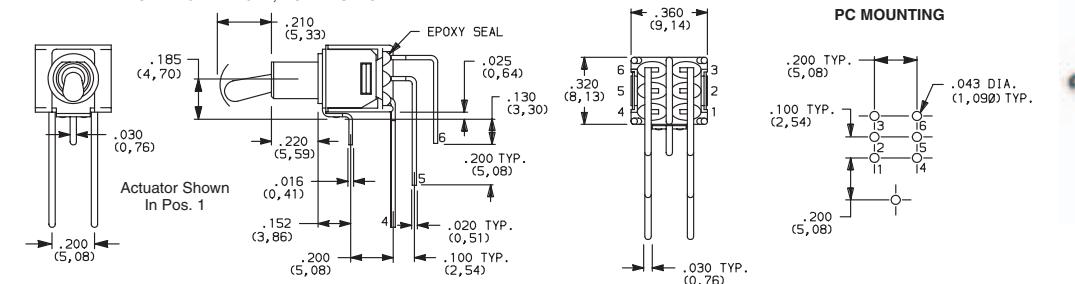

**NOTE:** Terminal bend radii and lead-in manufacturing option.

### V3 VERTICAL MOUNT, V-BRACKET

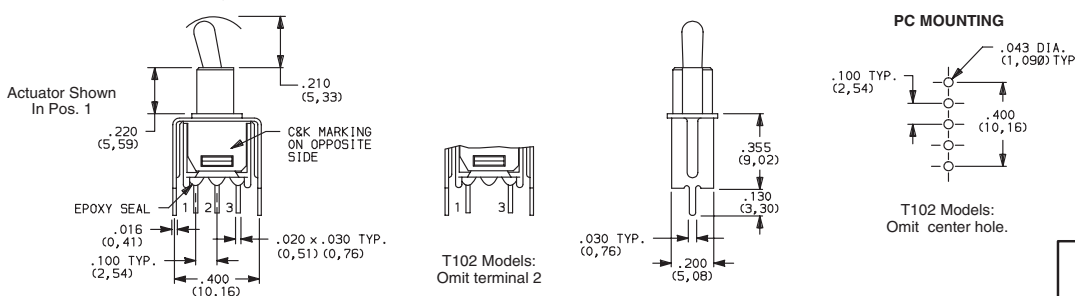

Dimensions are shown: Inches (mm)  
Specifications and dimensions subject to change

www.ck-components.com



# T Series Subminiature Toggle Switches

## TERMINATIONS

### V3 VERTICAL MOUNT, V-BRACKET



T201MH9V3BE  
DPDT

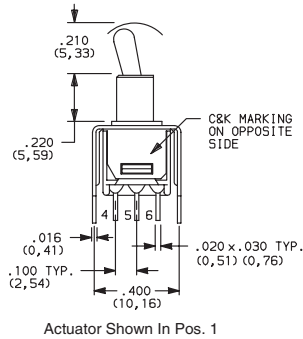

Actuator Shown In Pos. 1

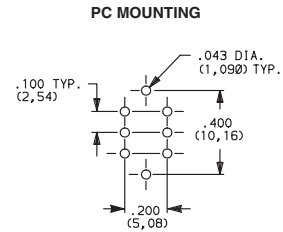
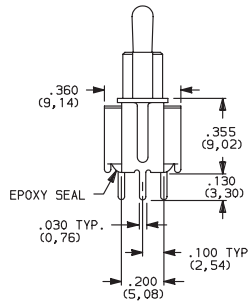

## CONTACT MATERIAL

OPTION CODE	CONTACT MATERIAL	TERMINAL PLATING	RATINGS	
<b>B</b>	GOLD <sup>1</sup>	GOLD <sup>1</sup>	LOW LEVEL/ DRY CIRCUIT	0.4 VA MAX. @ 20 V AC OR DC MAX.
<b>P</b>		MATTE-TIN <sup>6</sup>		
<b>Q</b>	SILVER <sup>4,5</sup>	SILVER <sup>5</sup>	POWER	TX01 MODELS: 3 AMPS @ 120 V AC OR 28 V DC. ALL OTHER MODELS: 2 AMPS @ 120 V AC OR 28 V DC.
<b>G</b>	GOLD OVER SILVER <sup>2,3</sup>	GOLD <sup>3</sup>	LOW LEVEL/DRY CIRCUIT OR POWER	TX01 MODELS: 0.4 VA MAX @ 20 V AC OR DC MAX. OR 3 AMPS @ 120 V AC OR 28 V DC. ALL OTHER MODELS: 0.4 VA MAX @ 20 V AC OR DC MAX. OR 2 AMPS @ 120 V AC OR 28 V DC.
<b>R</b>		MATTE-TIN <sup>6</sup>		

\* Note: See Technical Data section of this catalog for RoHS compliant and compatible definitions and specifications.

- <sup>1</sup> CONTACTS & TERMINALS: Copper alloy, with gold plate over nickel plate.
- <sup>2</sup> END CONTACTS: Coin silver, with gold plate over nickel plate.
- <sup>3</sup> CENTER CONTACTS & ALL TERMINALS: Copper alloy, with gold plate over nickel plate.
- <sup>4</sup> END CONTACTS: Coin silver, silver plated.
- <sup>5</sup> CENTER CONTACT & ALL TERMINALS: Copper alloy, silver plated.
- <sup>6</sup> TERMINALS: Copper alloy, with matte-tin over nickel plate.

All models  with all options when ordered with R, G, or Q contact material.  
B contact material standard with A, AV, V3 & W terminations.  
Q contact material standard with C & Z terminations.

## SEAL

### E EPOXY SEAL

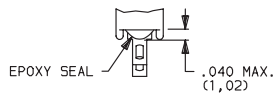

## AVAILABLE HARDWARE

### 759D02000 SEALING BOOT

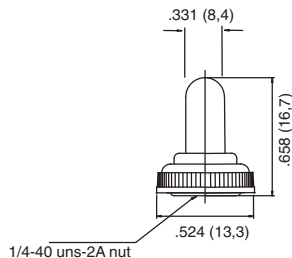

\* Note: For use with S1 actuator style when combined with T, TK, and CF bushings.



Dimensions are shown: Inches (mm)  
Specifications and dimensions subject to change

[www.ck-components.com](http://www.ck-components.com)

