

Interactive Catalog Supplements Catalog PDFs

If you need detailed product information, or help choosing the right product for your application, see our [Interactive Catalog](#). Use the [Interactive Catalog](#) to access the most complete and up-to-date information available.

The [Interactive Catalog](#) provides an extensive collection of product specifications, application data, and technical literature that can be searched based on criteria you select.

This PDF catalog information was published in November 2000.



Sensing and Control
[Interactive Catalog...](#)

**Click this icon to try
the Interactive Catalog.**

Sensing and Control

Honeywell Inc.

11 West Spring Street

Freeport, IL 61032

Manual Switches

Rocker Button Switches

TP Series

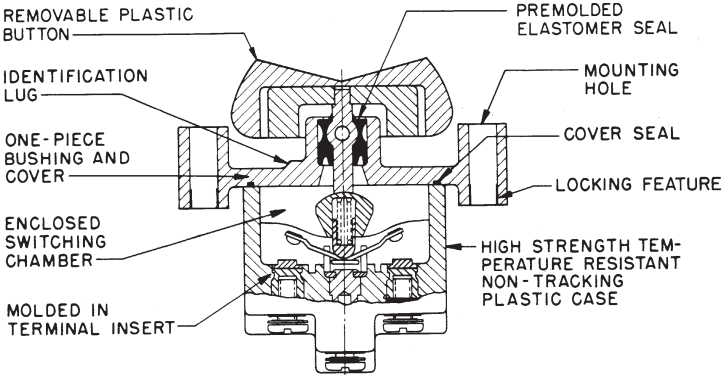

| UL/CSA Rating Code | Electrical Rating |
|--------------------|--|
| L192 | 10 amps-125, 250, 277 VAC; 1/4 Hp-125 VAC; 1/2 Hp-250, 277 VAC 3 Amps-125 VAC "L" |
| L191 | 15 amps-125, 250, 277 VAC; 1/2 Hp-125 VAC; 1Hp-250, 277 VAC 5 amps-120 VAC "L" |

Application Note: Honeywell MICRO SWITCH does *not* recommend the use of silver cadmium oxide switch contacts in non-arcing loads. Non-arcing loads are generally loads less than 12 volts and/or 0.5 amp. TP switches use silver cadmium oxide contacts. For other options, contact the MICRO SWITCH Application Center at 1-800-537-6945.

FEATURES

- 2 and 3 position pushbutton action
- Various button colors
- 1, 2, and 4 pole circuitry
- Flush panel and above panel mounting
- Temperature range is from -65°F to +160°F (-54°C to +71°C)
- UL recognized, CSA certified
- CE approved

CONSTRUCTION

Above panel mounting gives a distinct button appearance. Flush panel mounting presents a low button profile.

TERMINAL CIRCUIT IDENTIFICATION

Terminal identifications are referred to in the order guides to indicate which circuits are made in each toggle position (i.e., 1-2 indicates circuit closure through terminals 1 and 2).

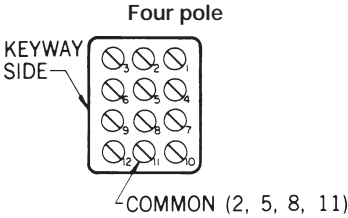
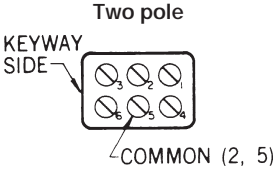
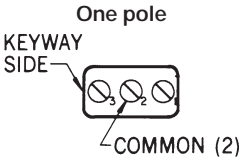

Toggle/Rockers

Manual Switches

Rocker Button Switches



Typical two-pole flush panel translucent button switch



Typical one-pole above panel transparent button switch

BUTTON OPTIONS

Buttons are removable and interchangeable. They measure .87" x 1.46" (22,1 x 37,1 mm).

Transparent (colorless plastic) buttons accept under-the-surface legend inserts for station and function identification. **Legend inserts are not furnished.** Insert legending can be done by your local supplier.

Translucent (white plastic) buttons have a clear appearance.

Colored (opaque plastic) buttons are excellent for color coding switch functions.

SWITCHES WITHOUT BUTTONS

To order switches without buttons, convert catalog listings shown in the order guides. Substitute **TP7** for TP4 and TP16 above panel mounted switches; substitute **TP8** for TP201 and TP12 flush panel mounted switches. Order buttons separately from the chart below.

BUTTON ORDER GUIDE

| Color | Catalog Listing |
|-------------|-----------------|
| Translucent | 12PA6 |
| Transparent | 12PA4 |
| White* | 12PA5-W |
| Yellow* | 12PA5-Y |
| Black* | 12PA5-BK |
| Green* | 12PA5-G |
| Red* | 12PA5-R |
| Blue* | 12PA5-BL |

* Opaque

2-POSITION ORDER GUIDE

Furnished with buttons.

| No. of Poles | Circuits Made with Button at: | | UL/CSA Rating Code | Elec. Rating Code | Catalog Listings | | | |
|--------------|-------------------------------|----------------------|--------------------|-------------------|--------------------|--------------------|--------------------|--------------------|
| | Ident. Lug Position | Opposite Ident. Lug | | | Flush Panel | | Above Panel | |
| | | | | | Translucent Button | Transparent Button | Translucent Button | Transparent Button |
| 1 | OFF | 2-3 | L191 | 1 | 1TP201-2 | 1TP12-2 | 1TP216-2 | 1TP4-2 |
| | OFF* | 2-3 | L192 | 2 | 1TP201-4 | — | — | — |
| | 1-2* | OFF | L192 | 2 | 1TP201-6 | 1TP12-6 | — | 1TP4-6 |
| | 1-2 | 2-3 | L191 | 1 | 1TP201-3 | 1TP12-3 | 1TP216-3 | 1TP4-3 |
| | 1-2* | 2-3 | L192 | 2 | 1TP201-8 | 1TP12-8 | 1TP216-8 | — |
| 2 | OFF | 2-3, 5-6 | L191 | 3 | 2TP201-2 | 2TP12-2 | 2TP216-2 | 2TP4-2 |
| | 1-2,4-5 | 2-3, 5-6 | L191 | 3 | 2TP201-3 | 2TP12-3 | 2TP216-3 | 2TP4-3 |
| | 1-2,4-5* | 2-3, 5-6 | L192 | 4 | 2TP201-8 | 2TP12-8 | 2TP216-8 | 2TP4-8 |
| 4 | OFF | 2-3, 5-6, 8-9, 11-12 | L191 | 5 | 4TP201-2 | 4TP12-2 | — | — |
| | OFF* | 2-3, 5-6, 8-9, 11-12 | L192 | 6 | — | — | 4TP216-4 | — |
| | 1-2, 4-5, 7-8, 10-11 | 2-3, 5-6, 8-9, 11-12 | L191 | 5 | 4TP201-3 | 4TP12-3 | 4TP216-3 | 4TP4-3 |
| | 1-2, 4-5, 7-8, 10-11* | 2-3, 5-6, 8-9, 11-12 | L192 | 6 | — | — | 4TP216-8 | — |
| | | | | | | | | |

* These positions only are momentary. All others are maintained.

Manual Switches

Rocker Button Switches

TP Series

3 - POSITION ORDER GUIDE

Furnished with buttons.

| No. of Poles | Circuits Made with Button at: | | | UL/CSA Rating Code | Elec. Rating Code | Catalog Listings | | | |
|--------------------------|-------------------------------|--------------------------|-------------------------|--------------------|-------------------|--------------------|--------------------|--------------------|--------------------|
| | Ident. Lug Position | Center Position | Opposite Lug Position | | | Flush Panel | | Above Panel | |
| | | | | | | Translucent Button | Transparent Button | Translucent Button | Transparent Button |
| 1 | 1-2 | OFF | 2-3 | L191 | 1 | 1TP201-1 | 1TP12-1 | 1TP216-1 | 1TP4-1 |
| | 1-2* | OFF | 2-3 | L192 | 2 | 1TP201-5 | 1TP12-5 | 1TP216-5 | 1TP4-5 |
| | 1-2* | OFF | 2-3* | L192 | 2 | 1TP201-7 | 1TP12-7 | 1TP216-7 | 1TP4-7 |
| | NONE** | OFF | 2-3 | L191 | 1 | 1TP201-21 | 1TP12-21 | — | 1TP4-21 |
| | NONE** | 1-2 | 2-3 | L191 | 1 | 1TP201-31 | 1TP12-31 | — | 1TP4-31 |
| | NONE** | 1-2 | 2-3* | L192 | 2 | 1TP201-51 | 1TP12-51 | 1TP216-51 | 1TP4-51 |
| | 1-2* | OFF | NONE** | L192 | 2 | 1TP201-61 | 1TP12-61 | 1TP216-61 | 1TP4-61 |
| 2 | 1-2, 4-5 | OFF | 2-3, 5-6 | L191 | 3 | 2TP201-1 | 2TP12-1 | 2TP216-1 | 2TP4-1 |
| | 1-2, 4-5* | OFF | 2-3, 5-6 | L192 | 4 | 2TP201-5 | 2TP12-5 | 2TP216-5 | 2TP4-5 |
| | 1-2, 4-5* | OFF | 2-3, 5-6* | L192 | 4 | 2TP201-7 | 2TP12-7 | 2TP216-7 | 2TP4-7 |
| | NONE** | OFF | 2-3, 5-6 | L191 | 3 | 2TP201-21 | 2TP12-21 | 2TP216-21 | 2TP4-21 |
| | NONE** | 1-2, 4-5 | 2-3, 5-6 | L191 | 3 | 2TP201-31 | 2TP12-31 | 2TP216-31 | 2TP4-31 |
| | NONE** | 1-2, 4-5 | 2-3, 5-6* | L192 | 4 | 2TP201-512 | 2TP12-512 | 2TP216-512 | 2TP4-512 |
| | 1-2, 4-5* | OFF | NONE** | L192 | 4 | 2TP201-61 | 2TP12-61 | 2TP216-61 | 2TP4-61 |
| | 1-2, 4-5 | 1-2, 5-6 | 2-3, 5-6 | L191 | 3 | 2TP201-10† | 2TP12-10 | 2TP216-10 | 2TP4-10 |
| | 1-2, 4-5* | 1-2, 5-6 | 2-3, 5-6 | L192 | 4 | 2TP201-50† | 2TP12-50 | 2TP216-50 | 2TP4-50 |
| | 1-2, 4-5* | 1-2, 5-6 | 2-3, 5-6* | L192 | 4 | 2TP201-70† | 2TP12-70 | 2TP216-70 | 2TP4-70 |
| 4 | 1-2, 4-5, 7-8, 10-11 | OFF | 2-3, 5-6 8-9, 11-12 | L191 | 5 | 4TP201-1 | 4TP12-1 | 4TP216-1 | 4TP4-1 |
| | 1-2, 4-5 7-8, 10-11* | OFF | 2-3, 5-6 8-9, 11-12 | L192 | 6 | 4TP201-5 | 4TP12-5 | — | 4TP4-5 |
| | 1-2, 4-5, 7-8, 10-11* | OFF | 2-3, 5-6 8-9, 11-12* | L192 | 6 | 4TP201-7 | 4TP12-7 | 4TP216-7 | 4TP4-7 |
| | NONE** | OFF | 2-3, 5-6, 8-9, 11-12 | L191 | 5 | 4TP201-21 | 4TP12-21 | 4TP216-21 | 4TP4-21 |
| | NONE** | 1-2, 4-5 7-8, 10-11 | 2-3, 5-6, 8-9, 11-12 | L191 | 5 | 4TP201-31 | — | 4TP216-31 | 4TP4-31 |
| | NONE** | 1-2, 4-5 7-8, 10-11 | 2-3, 5-6 8-9, 11-12* | L192 | 6 | 4TP201-51 | — | 4TP216-51 | 4TP4-51 |
| | 1-2, 4-5, 7-8, 10-11* | OFF | NONE** | L192 | 6 | 4TP201-61 | 4TP12-61 | 4TP216-61 | 4TP4-61 |
| | 1-2, 4-5, 7-8, 10-11 | 2-3, 4-5 | 2-3, 5-6, 8-9, 11-12 | L191 | 5 | 4TP201-10† | 4TP12-10 | — | 4TP4-10 |
| | 1-2, 4-5, 7-8, 10-11* | 2-3, 4-5 7-8, 11-12 | 2-3, 5-6, 8-9, 11-12 | L192 | 6 | 4TP201-50† | 4TP12-50 | 4TP216-50 | 4TP4-50 |
| 1-2, 4-5, 7-8, 10-11* | 2-3, 4-5 | 2-3, 5-6, 8-9, 11-12* | L192 | 6 | 4TP201-70† | 4TP12-70 | 4TP216-70 | 4TP4-70 | |

*These positions only are momentary. All others are maintained.

**Operator is blocked from these positions. Switch becomes two position, with center being one extreme position.

† Special on-on-on circuitry. See page 123.

Toggle/Rockers

Manual Switches

Rocker Button Switches

TP Series

MOUNTING DIMENSIONS (For reference only)

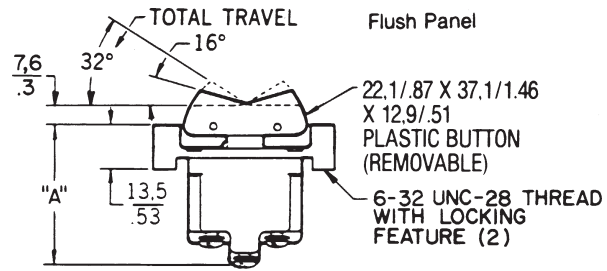
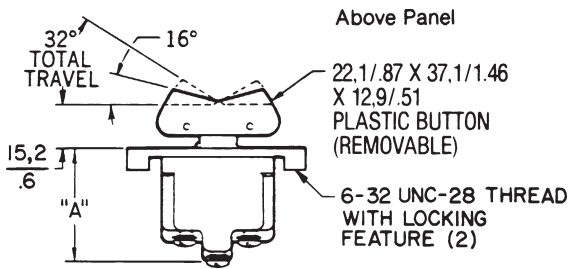

| DIM. "A" | |
|------------|-------------|
| 1-POLE | 29,5 / 1.16 |
| 2 & 4-POLE | 34,4 / 1.35 |

| DIM. "A" | |
|------------|-------------|
| 1-POLE | 36,8 / 1.45 |
| 2 & 4-POLE | 41,7 / 1.64 |

Panel cutout

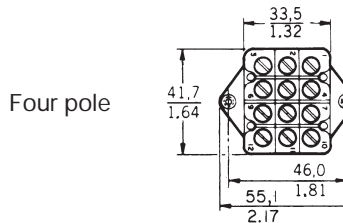
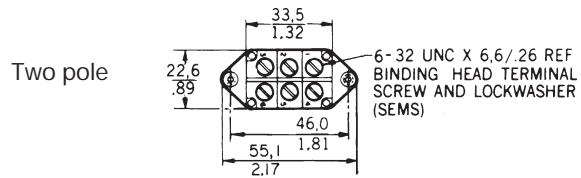
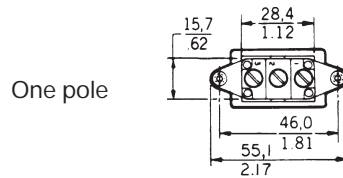
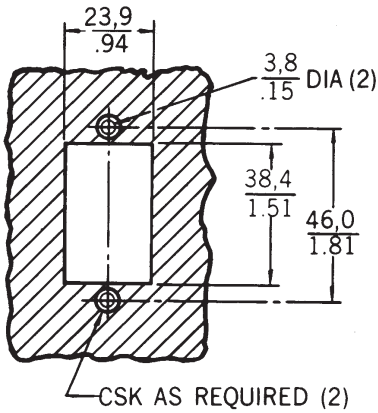

Key: $\frac{0,0}{0.00} = \text{mm}$
 $\frac{0,00}{0.00} = \text{inches}$

Flange mounting torque is 10-12 in./lbs.
 Terminal screw mounting torque is 5 in./lbs. max.