

General Specifications

B Electrical Capacity (Resistive Load)

Power Level (silver): 6A @ 125V AC & 3A @ 250V AC
4A @ 30V DC for On-None-On; 3A @ 30V DC for all other circuits

Logic Level (gold): 0.4VA maximum @ 28V AC/DC maximum
(Applicable Range 0.1mA ~ 0.1A @ 20mV ~ 28V)

Logic/Power Level (gold over silver): Combines silver & gold ratings
Note: Find additional explanation of dual rating & operating range in Supplement section.

Other Ratings

Contact Resistance: 10 milliohms maximum for silver; 20 milliohms maximum for gold

Insulation Resistance: 1,000 megohms minimum @ 500V DC

Dielectric Strength: 1,000V AC minimum between contacts for 1 minute minimum;
1,500V AC minimum between contacts and case for 1 minute minimum

Mechanical Life: 50,000 operations minimum

Electrical Life: 25,000 operations minimum for silver; 50,000 operations minimum for gold;
50,000 operations minimum for silver at 3A @ 125V AC

Angle of Throw: 25°

Materials & Finishes

Actuator Clip & Mounting Frame: Stainless Steel

Body Frame: Stainless steel

Case: Diallyl phthalate resin (UL94V-0)

Movable Contactor: Phosphor bronze with silver or gold plating

Movable Contacts: Silver alloy (code W); copper with gold plating (code G); or silver alloy with gold plating (code A)

Stationary Contacts: Silver with silver plating (code W); copper or brass with gold plating (code G);
or silver with gold plating (code A)

Terminals: Copper or brass with silver plating; or copper or brass with gold plating

Environmental Data

Operating Temp Range: -30°C through +85°C (-22°F through +185°F)

Humidity: 90 ~ 95% humidity for 96 hours @ 40°C (104°F)

Vibration: 10 ~ 55Hz with peak-to-peak amplitude of 1.5mm traversing the frequency range & returning
in 1 minute; 3 right angled directions for 2 hours

Shock: 50G (490m/s²) acceleration (tested in 6 right angled directions, with 5 shocks in each direction)

Processing

Soldering: Wave Soldering (PC version) for Gold: See Profile A in Supplement section.

Manual Soldering for Gold: See Profile A in Supplement section.

Wave Soldering (PC version) for Silver: See Profile B in Supplement section.

Manual Soldering for Silver: See Profile B in Supplement section.

Note: Actuator must be in OFF (center) position while soldering.

Cleaning: These devices are not process sealed. Hand clean locally using alcohol based solution.

Standards & Certifications

Flammability Standards: UL94V-0 for case

UL: File No. E44145

All models recognized at 6A @ 125V AC or 3A @ 250V AC or
0.4VA maximum @ 28V DC maximum.

Add "/U" to end of part number to order UL mark on switch.

CSA: File No. 023535_0_000

All models recognized at 6A @ 125V AC or 3A @ 250V AC or
0.4VA maximum @ 28V maximum.

Add "/C" to end of part number to order CSA mark on switch.

Distinctive Characteristics

Three methods of panel mounting: flat frame for flush with face or subpanel, snap-in, and PCB.

High insulating barriers increase isolation of circuits in multipole devices and provide added protection to contact points.

The molded diallyl phthalate case has a UL 94V-0 flammability rating.

Epoxy sealed terminals prevent entry of solder flux and other contaminants.

Prominent external insulating barriers increase insulation resistance and dielectric strength.

Bias guard prevents misalignment of contacts; interlocking of actuator block with rocker and internal guide does not allow transmission of diagonal force on rocker to reach contact mechanism.

Clinching of the frame to the case well above the base and terminals provides 1,500V dielectric strength.

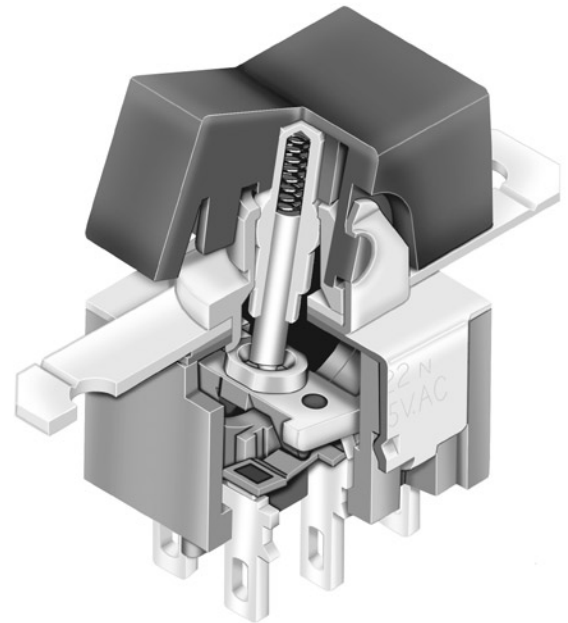

Actual Size

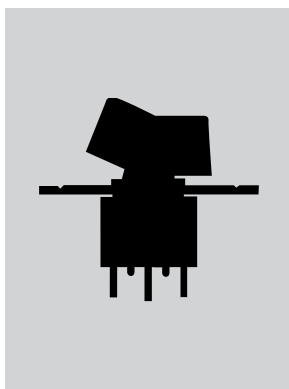

- Toggle
- B** Rockers
- Pushbuttons
- Illuminated PB
- Programmable
- Keylocks
- Rotaries
- Slides
- Tactiles
- Tilt
- Touch
- Indicators
- Accessories
- Supplement

TYPICAL SWITCH ORDERING EXAMPLE

M20 **1** **3** **TX** **G**

| Poles | |
|-------|--|
| 1 | SPDT |
| 2 | DPDT SP3T |
| 3 | 3PDT (used only with terminal codes 30 & 41 & frame code TX) |
| 4 | 4PDT DP3T (used only with terminal code 41 & frame code TX) |

| Mounting Frames | |
|-----------------|---------------------------------|
| TX | Narrow Frame for Small Actuator |
| TZ | Wide Frame for Large Actuator |

| Circuits | | | |
|----------|------|------|------|
| 2 | ON | NONE | ON |
| 3 | ON | OFF | ON |
| 5 | ON | NONE | (ON) |
| 8 | (ON) | OFF | (ON) |
| 9 | ON | OFF | (ON) |
| *4 | ON | ON | ON |
| *6 | (ON) | ON | (ON) |
| *7 | ON | ON | (ON) |

() = Momentary
* 3-ON circuits

| Contact Materials & Ratings | |
|-----------------------------|--|
| W | Silver; Rated 6A @ 125V AC & 3A @ 250V AC |
| G | Gold; Rated 0.4VA max @ 28V AC/DC max |
| A | Gold over Silver; Rated 6A @ 125V AC & 0.4VA max @ 28V AC/DC max |

41 **D** **C**

| Terminals For TX & TZ Frames | |
|---|---|
| Straight PC with Bracket (1-2 Pole only) | |
| 13 | .250" (6.35mm) Straight PC with .465" (11.8mm) Bracket |
| 15 | .425" (10.8mm) Straight PC with .630" (16.0mm) Bracket |
| 17 | .964" (24.5mm) Straight PC with 1.150" (29.2mm) Bracket |
| Straight PC with Reinforced Bracket (1-2 Pole only) | |
| 23 | .250" (6.35mm) Straight PC with .465" (11.8mm) Bracket |
| 25 | .425" (10.8mm) Straight PC with .630" (16.0mm) Bracket |
| 26 | .750" (19.05mm) Straight PC with .953" (24.2mm) Bracket |
| Terminals For TX Frame Only | |
| Right Angle PC with Support (1-3 Pole only) | |
| 30 | .150" (3.81mm) Right Angle PC |
| Vertical PC with Support (1-4 Pole) | |
| 41 | .150" (3.81mm) Vertical PC |

| Rockers & Paddles | |
|----------------------------|-----------------------------|
| Small Actuators (TX Frame) | |
| D | .365" (9.27mm) Wide Rocker |
| E | .365" (9.27mm) Wide Paddle |
| F | .450" (11.43mm) Wide Rocker |
| G | .450" (11.43mm) Wide Paddle |
| Large Actuators (TZ Frame) | |
| J | .595" (15.11mm) Wide Rocker |
| H | .595" (15.11mm) Wide Paddle |

| Rocker & Paddle Colors | |
|------------------------|--------|
| A | Black |
| B | White |
| C | Red |
| E | Yellow |
| F | Green |
| G | Blue |
| H | Gray |

IMPORTANT:



Switches are supplied without UL & CSA marking unless specified. Specific models & ratings noted on General Specifications page.

DESCRIPTION FOR TYPICAL ORDERING EXAMPLE

M2013TXG41-DC

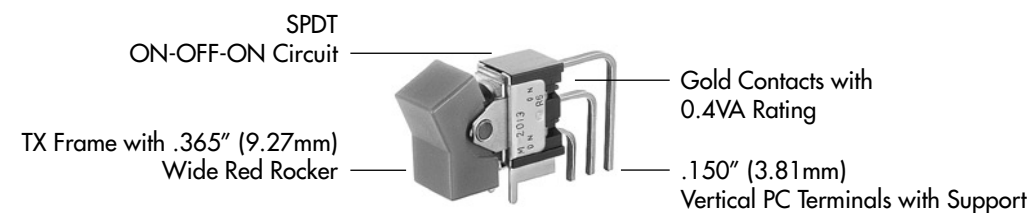

DESCRIPTION FOR TYPICAL ORDERING EXAMPLE

M2022TZG23-JC

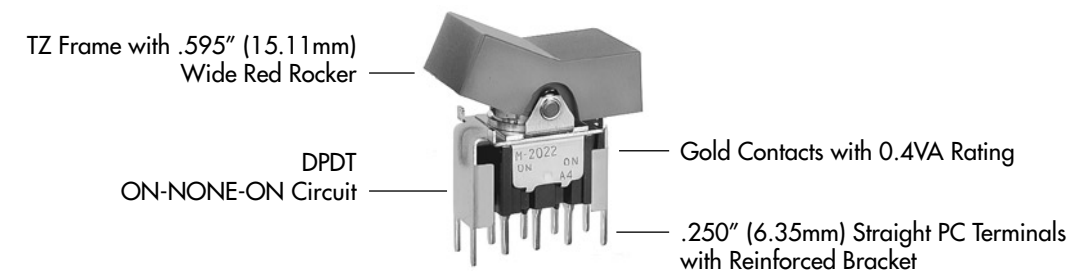

POLES & CIRCUITS

| Pole | Model | Rocker Position () = Momentary | | | Connected Terminals | | | Throw & Schematics |
|------|---|------------------------------------|-----------------------------------|----------------------------------|----------------------|--------|----------------------|---|
| | | Down | Center | Up | Down | Center | Up | |
| SP | M2012 M2013 *M2015 M2018 *M2019 | ON ON ON (ON) ON | NONE OFF NONE OFF OFF | ON ON (ON) (ON) (ON) | 2-3 | OPEN | 2-1 | Note: Terminal numbers are not actually on the switch. * Reverse circuits available for vertical mount SP & DP upon request. SPDT |
| DP | M2022 M2023 *M2025 M2028 *M2029 | ON ON ON (ON) ON | NONE OFF NONE OFF OFF | ON ON (ON) (ON) (ON) | 2-3 5-6 | OPEN | 2-1 5-4 | DPDT |
| 3P | M2022 M2023 *M2025 M2028 *M2029 | ON ON ON (ON) ON | NONE OFF NONE OFF OFF | ON ON (ON) (ON) (ON) | 2-3 5-6 8-9 | OPEN | 2-1 5-4 8-7 | 3PDT |
| 4P | M2042 M2043 *M2045 M2048 *M2049 | ON ON ON (ON) ON | NONE OFF NONE OFF OFF | ON ON (ON) (ON) (ON) | 2-3 5-6 8-9 11-12 | OPEN | 2-1 5-4 8-7 11-10 | 4PDT |

For 3 Throw (3-On)

Connected Terminals & Schematics

| Pole | Model | Down | Center | Up | Down | Center | Up |
|------|-------------------------|------------------|----------------|--------------------|--------------------------|--------------------------|--------------------------|
| SP | M2024 M2026 M2027 | ON (ON) ON | ON ON ON | ON (ON) (ON) | 2-3 5-6 | 2-3 5-4 | 2-1 5-4 |
| DP | M2044 M2046 M2047 | ON (ON) ON | ON ON ON | ON (ON) (ON) | 2-3 5-6 8-9 11-12 | 2-3 5-4 8-9 11-10 | 2-1 5-4 8-7 11-10 |

The SP3T model utilizes a double pole base.

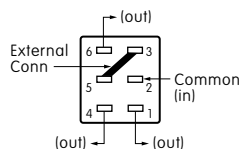

External connection must be made during field installation.

The DP3T model utilizes a four pole base.

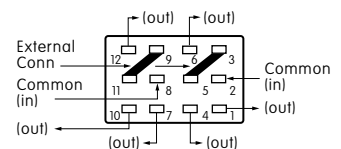

External connection must be made during field installation.

MOUNTING FRAMES

TX Narrow Mounting Frame for Small Actuators with Straight PC Terminals (codes 13, 15, 17, 23, 25, & 26) or with Angle PC Terminals (codes 30 & 41)

Straight PC Mounting



Right Angle PC Mounting

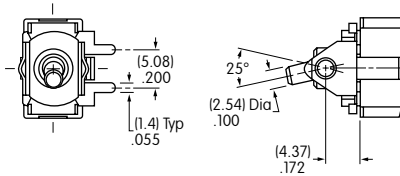

Vertical PC Mounting



Small Actuators & Panel Cutouts for TX Frame (actuator details on the following pages)

AT4148

AT4149

AT4150

AT4151

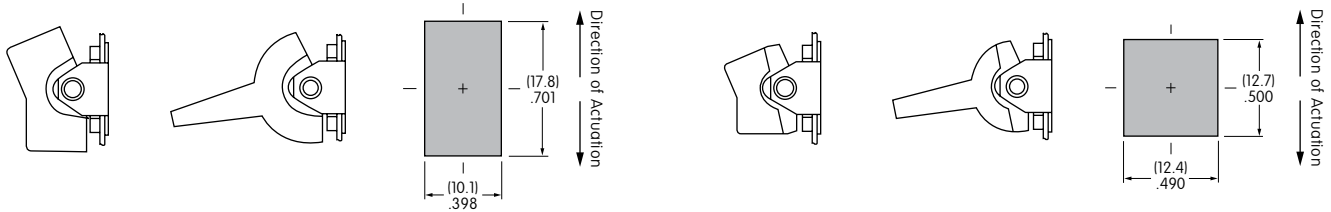

TZ Wide Mounting Frame for Large Actuators with Straight PC Terminals (codes 13, 15, 17, 23, 25, & 26)

Large Actuators & Panel Cutouts for TZ Frame (actuator details on the following pages)

AT4156

AT4157

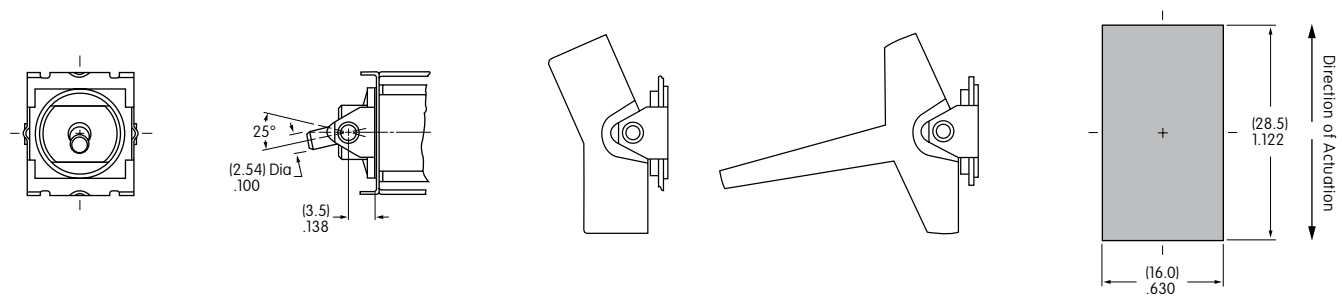

CONTACT MATERIALS & RATINGS

W Silver over Silver Power Level 6A @ 125V AC & 3A @ 250V AC

G Gold over Brass or Copper Logic Level 0.4VA maximum @ 28V AC/DC maximum

Note: See Supplement section to find complete explanation of operating range.

A Gold over Silver Power Level or Logic Level 6A @ 125V AC or 0.4VA maximum @ 28V AC/DC maximum

Note: This dual rated option is suitable when two or more identical switches are used in logic and in power circuits within the same application. See Supplement section to find complete explanation of dual rating and operating range.

Toggles
Rockers
Pushbuttons
Illuminated PB
Programmable
Keylocks
Rotaries
Slides
Tactiles
Tilt
Touch
Indicators
Accessories
Supplement

TERMINALS

For TX and TZ 1-2 Pole
Straight PC Mount with Bracket

For TX and TZ 1-2 Pole
Straight PC Mount with Reinforced Bracket

13

.250" (6.35mm)
Terminal with
.465" (11.8mm)
Bracket

15

.425" (10.8mm)
Terminal with
.630" (16.0mm)
Bracket

17

.964" (24.5mm)
Terminal with
1.150" (29.2mm)
Bracket

23

.250" (6.35mm)
Terminal with
.465" (11.8mm)
Bracket

25

.425" (10.8mm)
Terminal with
.630" (16.0mm)
Bracket

26

.750" (19.05mm)
Terminal with
.953" (24.2mm)
Bracket

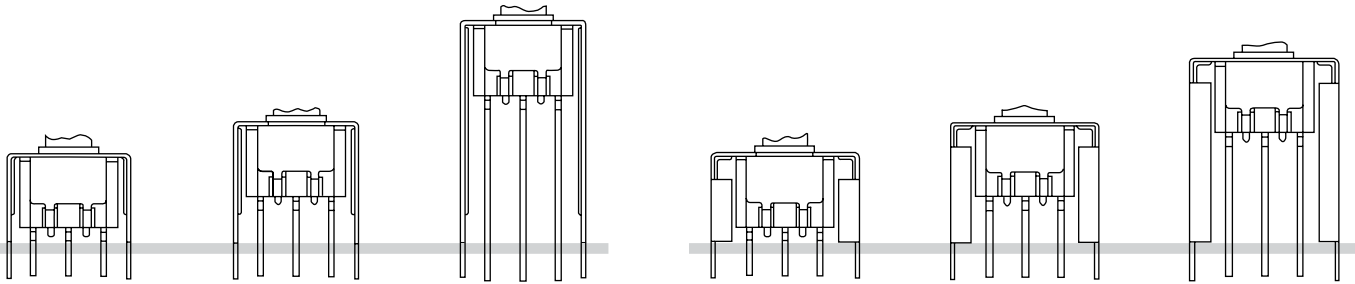

PCB footprints are on the following Typical Switch Dimension pages.

For TX 1-3 Pole Right Angle PC Mount

For TX 1-4 Pole Vertical PC Mount

30

.150" (3.81mm)
Right Angle PC

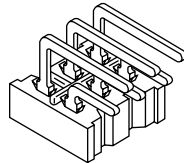

41

.150" (3.81mm)
Vertical PC

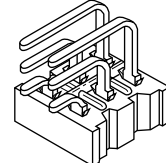

ROCKERS & PADDLES FOR TX MOUNTING FRAMES

D

AT4148 .365" (9.27mm)
Wide Rocker

Material: Polyamide
Finish: Matte

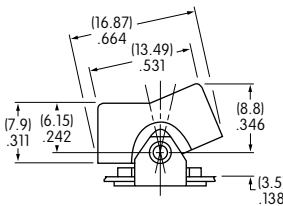
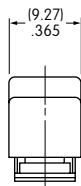

E

AT4149 .365" (9.27mm)
Wide Paddle

Material: Polyamide
Finish: Matte

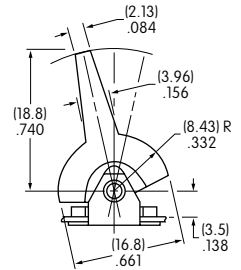

F

AT4150 .450" (11.43mm)
Wide Rocker

Material: Polyamide
Finish: Matte

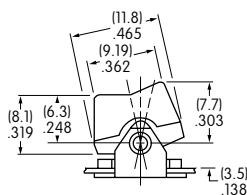
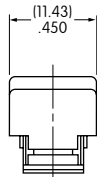

G

AT4151 .450" (11.43mm)
Wide Paddle

Material: Polyamide
Finish: Matte

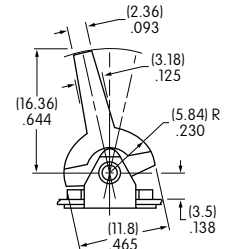
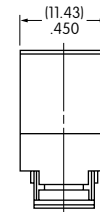

Cap Colors
Available:

A

Black

B

White

C

Red

E

Yellow

F

Green

G

Blue

H

Gray

ROCKERS & PADDLES FOR TZ MOUNTING FRAMES

J AT4156 .595" (15.11mm)
Wide Rocker

Material: Polyamide
Finish: Matte

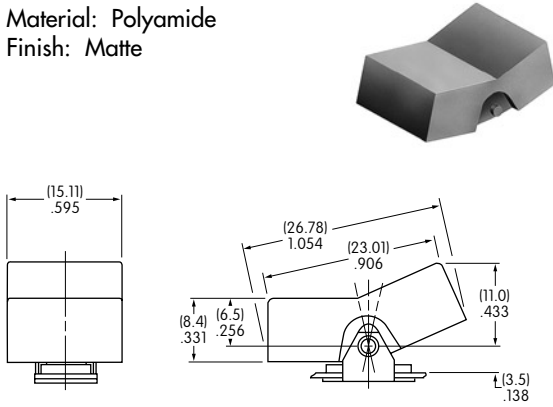

H AT4157 .595" (15.11mm)
Wide Paddle

Material: Polyamide
Finish: Matte

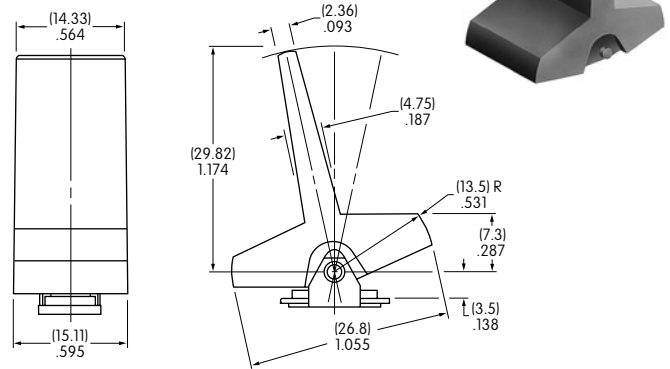

Cap Colors Available:



Black



White



Red



Yellow



Green



Blue



Gray

OPTIONAL SNAP-IN PANEL FRAMES

Used with AT4148 Rocker and AT4149 Paddle

AT064-1

Accommodates .047" ~ .090"
(1.2 ~ 2.3mm) panel thickness

Material: Polyamide
Finish: Matte
Color: Black

Mounted separately from switches

Cutout Tolerances:

Dimension A:
.797" ~ .803" (20.24 ~ 20.4mm)

Dimension B:
.495" ~ .505" (12.57 ~ 12.83mm)



AT064-2

Accommodates .062" ~ .125"
(1.57 ~ 3.18mm) panel thickness

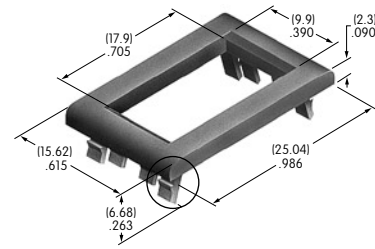

AT064-1 Enlarged Detail

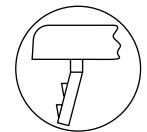

Used with AT4150 Rocker and AT4151 Paddle

AT065-1

Accommodates .047" ~ .090"
(1.2 ~ 2.3mm) panel thickness

Material: Polyamide
Finish: Matte
Color: Black

Mounted separately from switches

Cutout Tolerances:

Dimension A:
.595" ~ .605" (15.11 ~ 15.37mm)

Dimension B:
.495" ~ .500" (12.57 ~ 12.7mm)

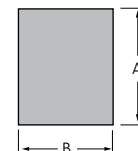

AT065-2

Accommodates .062" ~ .125"
(1.57 ~ 3.18mm) panel thickness

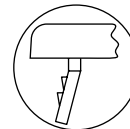
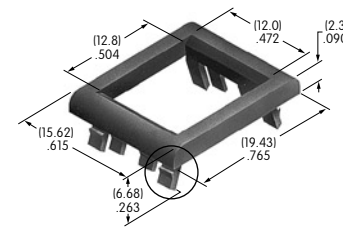

AT065-1 Enlarged Detail

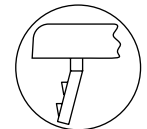

AT065-2 Enlarged Detail

TYPICAL SWITCH DIMENSIONS

Straight PC • Bracket

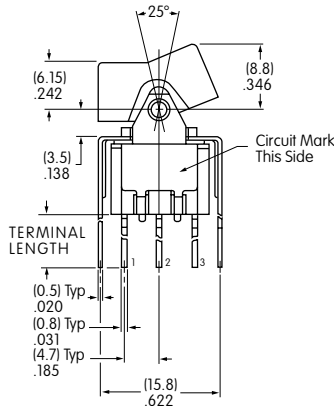

M2012TXG13-DC

| Terminal Code: | Terminal Length: | Bracket Length: |
|----------------|------------------|-----------------|
| 13 | .250" (6.35mm) | .465" (11.8mm) |
| 15 | .425" (10.8mm) | .630" (16.0mm) |
| 17 | .964" (24.5mm) | 1.150" (29.2mm) |

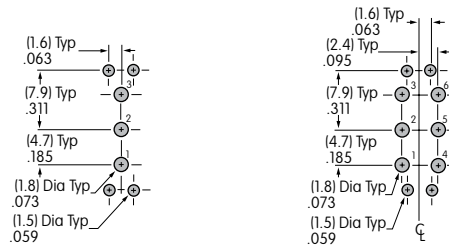

Straight PC • Reinforced Bracket



M2012TXG23-DC

| Terminal Code: | Terminal Length: | Bracket Length: |
|----------------|------------------|-----------------|
| 23 | .250" (6.35mm) | .465" (11.8mm) |
| 25 | .425" (10.8mm) | .630" (16.0mm) |
| 26 | .750" (19.05mm) | .953" (24.2mm) |

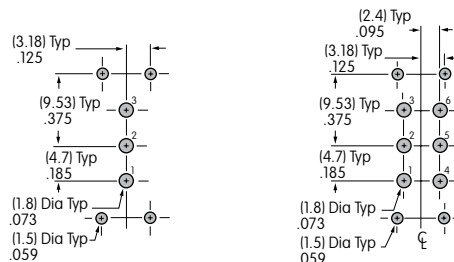

TYPICAL SWITCH DIMENSIONS

Single Pole

.150" (3.81 mm) Right Angle PC

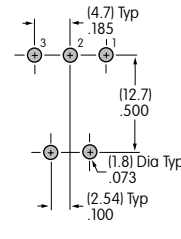
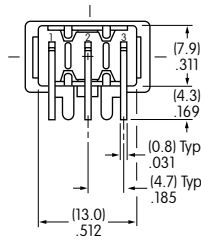
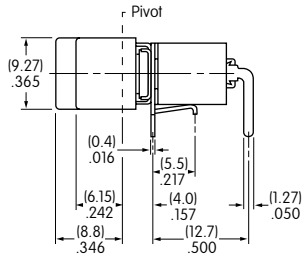
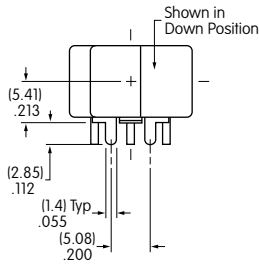

M2012TXG30-DC

Double Pole

.150" (3.81 mm) Right Angle PC

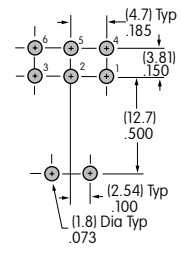
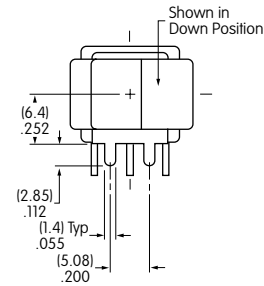

M2022TXG30-DC

Three Pole

.150" (3.81 mm) Right Angle PC

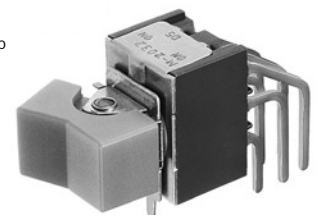
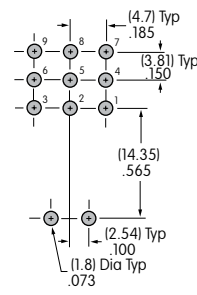
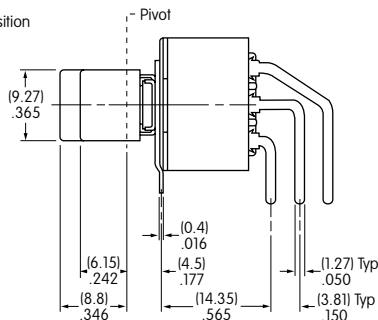
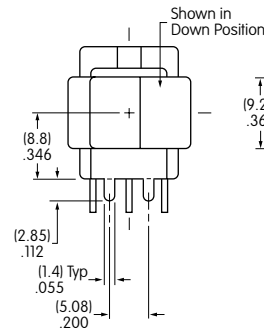

M2032TXG30-DC

TYPICAL SWITCH DIMENSIONS

.150" (3.81mm) Vertical PC

Single Pole

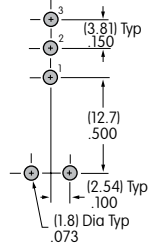
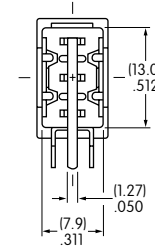
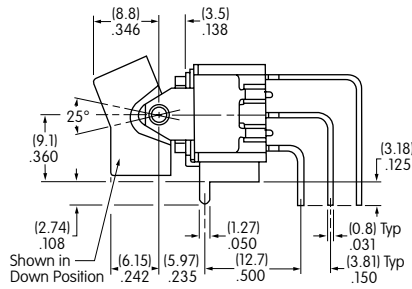
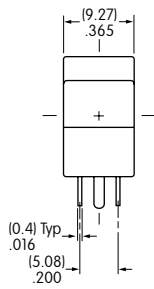

M2012TXG41-DC

.150" (3.81mm) Vertical PC

Double Pole

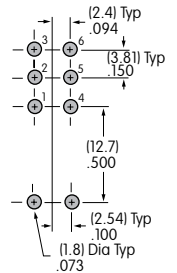
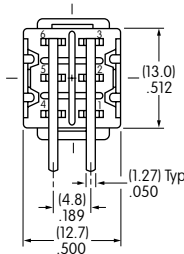
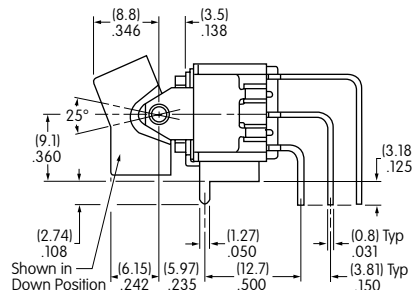
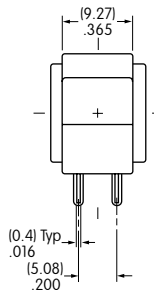

M2022TXG41-DC

.150" (3.81mm) Vertical PC

Three Pole

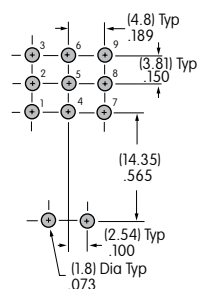
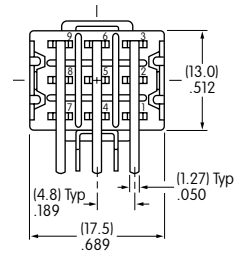
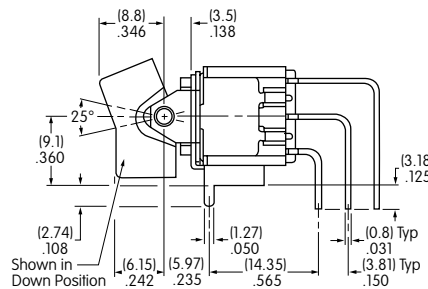
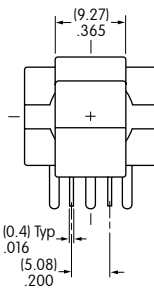
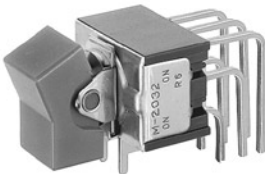

M2032TXG41-DC

.150" (3.81mm) Vertical PC

Four Pole

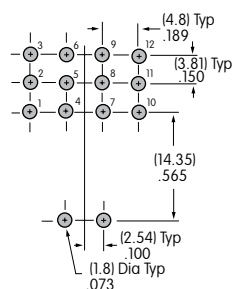
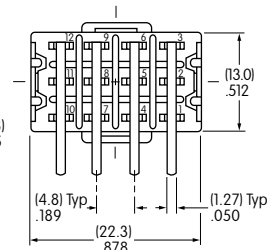
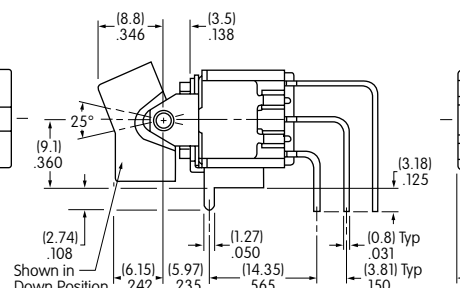
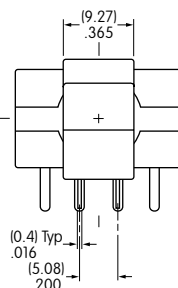

M2042TXG41-DC

Toggles

Rockers **B**

Pushbuttons

Illuminated PB

Programmable

Keylocks

Rotaries

Slides

Tactiles

Tilt

Touch

Indicators

Accessories

Supplement

TYPICAL SWITCH DIMENSIONS

Straight PC • Bracket

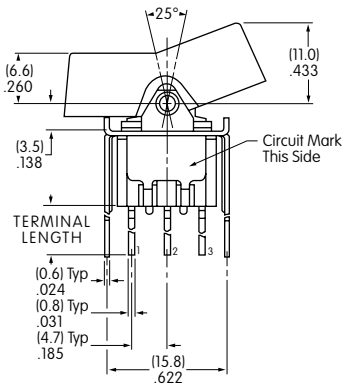

Single Pole



Double Pole



M2012ZG13-JC

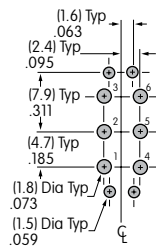
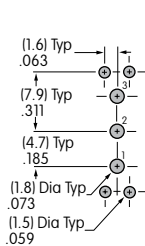

| Terminal Code: | Terminal Length: | Bracket Length: |
|----------------|------------------|-----------------|
| 13 | .250" (6.35mm) | .465" (11.8mm) |
| 15 | .425" (10.8mm) | .630" (16.0mm) |
| 17 | .964" (24.5mm) | 1.150" (29.2mm) |

Straight PC • Reinforced Bracket

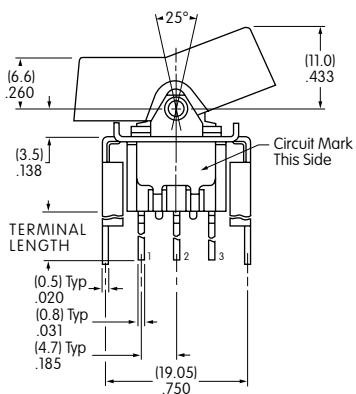

Single Pole

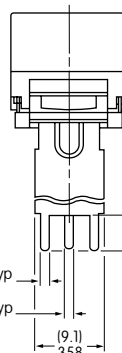

Double Pole

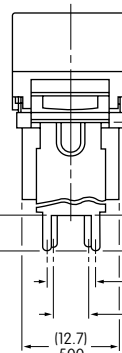

M2012ZG23-JC

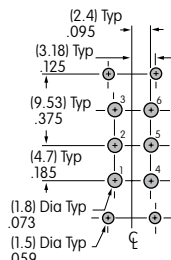
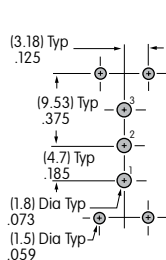

| Terminal Code: | Terminal Length: | Bracket Length: |
|----------------|------------------|-----------------|
| 23 | .250" (6.35mm) | .465" (11.8mm) |
| 25 | .425" (10.8mm) | .630" (16.0mm) |
| 26 | .750" (19.05mm) | .953" (24.2mm) |

LEGENDS

NKK Switches can provide custom legends for caps. Contact factory for more information.

Suggested Printable Area for Cap

AT4148

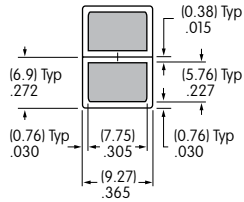

AT4150

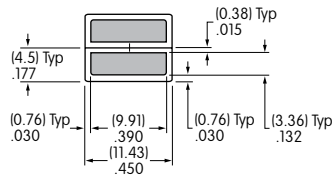

AT4156

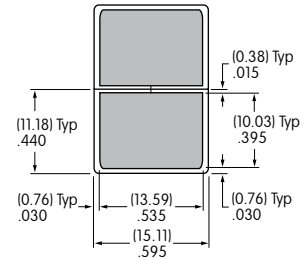
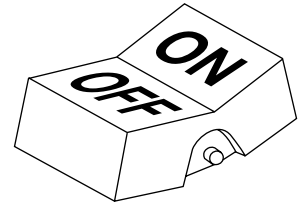

Shaded areas are printable areas.

Recommended Print Method:

Pad Print

Epoxy based ink is recommended.