

Reliable Thumbwheel with Easy-to-Mount Assembly

- Dustproof construction ensures highly reliable performance at low voltage and very small current even under adverse environmental conditions
- Plus (+) and minus (–) pushbuttons for positive forward and reverse rotation of each digital wheel

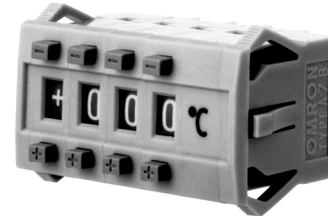

Ordering Information

■ SWITCH UNITS

Output Code	Part number			
	Front mounting solder terminals			
	Stopper pin provided		Stopper pin not provided	
	Light gray case	Black case	Light gray case	Black case
03 (decimal code)	–	–	A7BS-203	A7BS-203-1
06 (binary code) (binary code w/+, – display)	A7BS-206-S	A7BS-206-S-1	A7BS-206	A7BS-206-1
	–	–	A7BS-206-PM	A7BS-206-PM-1
07 (binary code w/diode provision)	A7BS-207-S	A7BS-207-S-1	A7BS-207	A7BS-207-1
19 (decimal code w/component adding provision)	–	–	A7BS-219	A7BS-219-1
54 (binary code hexadecimal)	–	–	A7BS-254	A7BS-254-1
55 (binary code hexadecimal, w/component adding provision)	–	–	A7BS-255	A7BS-255-1

■ ACCESSORIES

Accessory	Part number		
	For front mounting type switch assembly terminals		
	Light gray	Black	
End Cap	A7B-M	A7B-M-1	
Spacer	A7B-P□	A7B-P□-1	
Connector	Solder terminal	A7B-C	A7B-C
	PC terminal	A7B-CP	A7B-CP

- Note: 1. When placing your order, please specify the model numbers and quantities of required switch units, end caps, and spacers, respectively. (Note that switch units and accessories are not factory-assembled for shipment.)
2. Type with a suffix -S in their type number are provided with two stopper pins (Type A7BS-S: used in pairs) as standard accessories.
3. Switch case, end cap, and spacer are made of polyacetal resin; however, the window plate is polycarbonate resin.
4. One of the following alphabetic codes must be filled into the boxed part of the model number to specify a legend to be hot stamped on the required spacer.
5. End caps come as a set -- left and right.

Code	Legend	Code	Legend	Code	Legend
A	Hot stamp not required	E	g	K	°C
B	SEC	F	kg	L	PCS
C	MIN	G	mm	Q	x 10 SEC
D	H	H	cm	T	0
		J	m		

Specifications

■ CHARACTERISTICS

Switching capacity	1 mA to 0.1 A, 50 VAC/28 VDC (resistive load)	
Carry current	1 A (max.)	
Contact resistance	200 mΩ max.	
Insulation resistance	10 MΩ min. (at 500 VDC) between nonconnected terminals 1,000 MΩ min. (at 500 VDC) between each terminal and noncurrent-carrying part	
Dielectric strength	600 VAC, 50/60 Hz for 1 minute between nonconnected terminals 1,000 VAC, 50/60 Hz for 1 minute between each terminal and noncurrent-carrying part	
Operating force	550 g max.	
Vibration	10 to 55 Hz, 1.5 mm double amplitude	
Shock	500 m/s ² (approx. 50 G)	
Ambient temperature	Operating	-10° to 65°C
	Storage	-20° to 80°C
Humidity	45% to 85% RH max.	
Service life	Mechanical	100,000 operations (steps) min.
	Electrical	50,000 operations (steps) min.
Weight (per unit)	Approx. 4.1 g	

Note: Data shown are of initial value.

Dimensions

Unit: mm (inch)

■ SWITCH UNITS

A7BS-206(-1)

A7BS-207(-1)

A7BS-20□-S(-1)

Note: Dimension * is 32.5 (1.28) for the switch with output code "06" [i.e., A7BS-206(-1)], and 43.5 (1.71) for the switch with output code "07" [i.e., A7BS-207(-1)].

■ PANEL CUTOUT

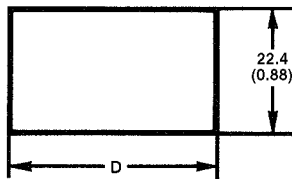

No. of units (n)	A (8n + 8)	B (8n + 6)	D
1	16 (0.63)	14 (0.55)	14.4 (0.57)
2	24 (0.94)	22 (0.87)	22.4 (0.88)
3	32 (1.26)	30 (1.18)	30.4 (1.20)
4	40 (1.57)	38 (1.50)	38.4 (1.51)
5	48 ± 0.8 (1.89 ± 0.03)	46 ± 0.8 (1.81 ± 0.03)	46.8 (1.84)
6	56 ± 0.8 (2.20 ± 0.03)	54 ± 0.8 (2.13 ± 0.03)	54.8 (2.16)
7	64 ± 0.8 (2.52 ± 0.03)	62 ± 0.8 (2.44 ± 0.03)	62.8 (2.47)
8	72 ± 0.8 (2.83 ± 0.03)	70 ± 0.8 (2.76 ± 0.03)	70.8 (2.79)
9	80 ± 0.8 (3.15 ± 0.03)	78 ± 0.8 (3.07 ± 0.03)	78.8 (3.10)
10	88 ± 0.8 (3.46 ± 0.03)	86 ± 0.8 (3.39 ± 0.03)	86.8 (3.42)

Note: 1. Unless otherwise specified, a tolerance of ± 0.4 mm applies to all dimensions.

2. Each model number applies to a single switch unit and not to the switch assembly as shown in the drawings.

■ END CAPS A7B-M(-1)

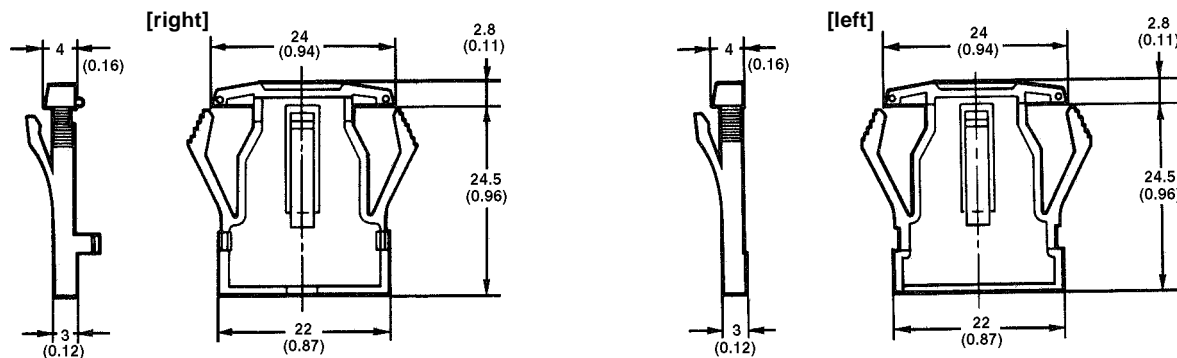

Note: End caps are attached to each end of the switch assembly and used to secure the switch assembly to a mounting panel.

■ STOPPER PINS A7BS-S

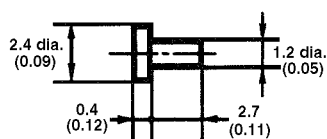

Note: Types with Suffix -S in their type numbers are provided with two stopper pins as standard accessories.

■ SPACERS A7B-P□(-1)

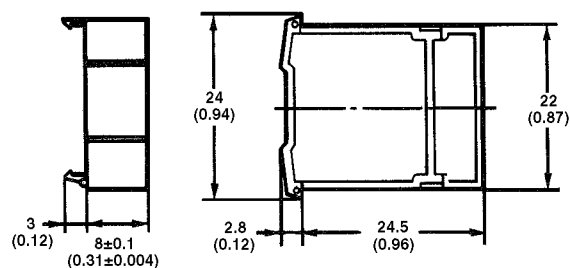

Unit: mm (inch)

■ CONNECTORS

A7B-C

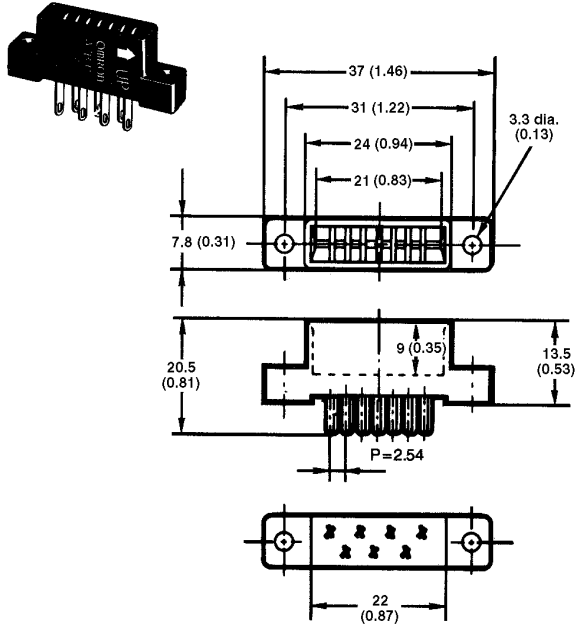

A7B-CP

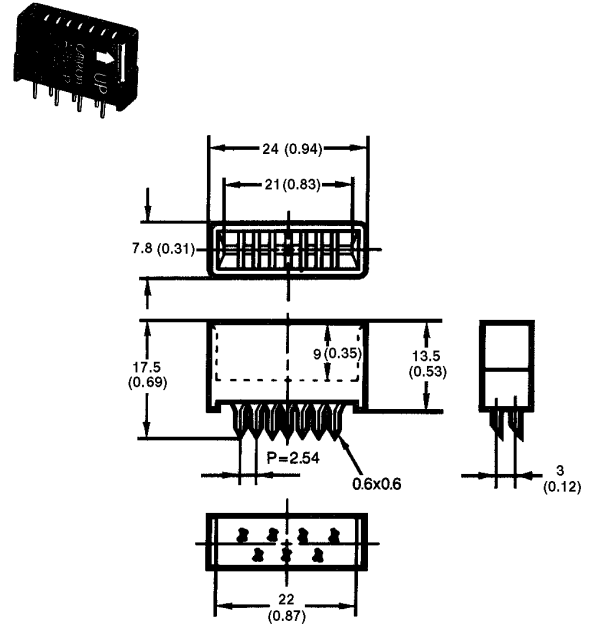

■ TERMINALS

A7BS-206(-1)

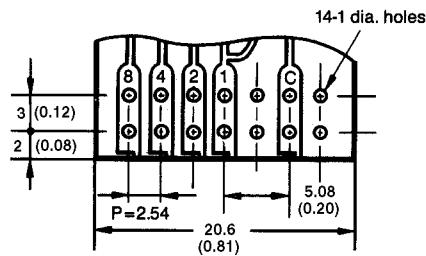

A7BS-207(-1)

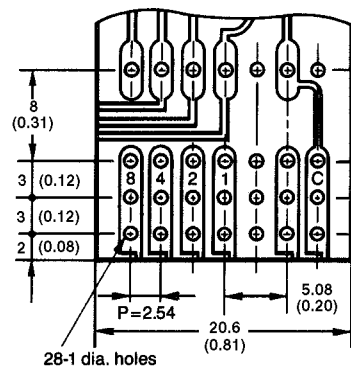

Hints on Correct Use

Refer to HINTS ON CORRECT USE under the General Information section.

NOTE: DIMENSIONS ARE SHOWN IN MILLIMETERS. To convert millimeters to inches divide by 25.4.

OMRON**OMRON ELECTRONICS LLC.**

One East Commerce Drive
Schaumburg, IL 60173

1-800-55-OMRON

Cat. No. GC SW6

04/01

OMRON ON-LINE

Global - <http://www.omron.com>
USA - <http://www.omron.com/oei>
Canada - <http://www.omron.com/oci>

Specifications subject to change without notice.

OMRON CANADA, INC.

885 Milner Avenue
Scarborough, Ontario M1B 5V8

416-286-6465

Printed in the U.S.A.