

MMBF5457LT1

Preferred Device

JFET - General Purpose Transistor

N-Channel

Features

- Pb-Free Package is Available

MAXIMUM RATINGS

Rating	Symbol	Value	Unit
Drain-Source Voltage	V_{DS}	25	Vdc
Drain-Gate Voltage	V_{DG}	25	Vdc
Reverse Gate-Source Voltage	$V_{GS(r)}$	-25	Vdc
Gate Current	I_G	10	mAdc

THERMAL CHARACTERISTICS

Characteristic	Symbol	Max	Unit
Total Device Dissipation FR-5 Board (Note 1) ($T_A = 25^\circ\text{C}$ Derate above 25°C)	P_D	225	mW
Thermal Resistance, Junction-to-Ambient	$R_{\theta JA}$	556	$^\circ\text{C/W}$
Junction and Storage Temperature	T_J, T_{stg}	-55 to +150	$^\circ\text{C}$

Maximum ratings are those values beyond which device damage can occur. Maximum ratings applied to the device are individual stress limit values (not normal operating conditions) and are not valid simultaneously. If these limits are exceeded, device functional operation is not implied, damage may occur and reliability may be affected.

1. FR-5 = $1.0 \times 0.75 \times 0.062$ in.



ON Semiconductor®

<http://onsemi.com>

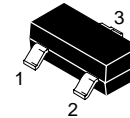
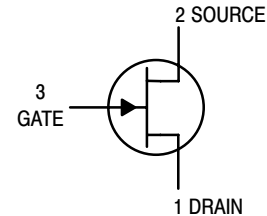

SOT-23 (TO-236)
CASE 318
STYLE 10

MARKING DIAGRAM

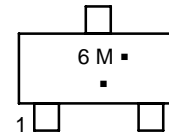

6 = Specific Device Code

M = Date Code*

■ = Pb-Free Package

(Note: Microdot may be in either location)

*Date Code orientation and/or overbar may vary depending upon manufacturing location.

ORDERING INFORMATION

Device	Package	Shipping†
MMBF5457LT1	SOT-23	3000/Tape & Reel
MMBF5457LT1G	SOT-23 (Pb-Free)	3000/Tape & Reel

†For information on tape and reel specifications, including part orientation and tape sizes, please refer to our Tape and Reel Packaging Specifications Brochure, BRD8011/D.

Preferred devices are recommended choices for future use and best overall value.

MMBF5457LT1

ELECTRICAL CHARACTERISTICS (T_A = 25°C unless otherwise noted)

Characteristic	Symbol	Min	Typ	Max	Unit
OFF CHARACTERISTICS					
Gate-Source Breakdown Voltage (I _G = 10 μAdc, V _{DS} = 0)	V _{(BR)GSS}	-25	-	-	Vdc
Gate Reverse Current (V _{GS} = 15 Vdc, V _{DS} = 0) (V _{GS} = 15 Vdc, V _{DS} = 0, T _A = 100°C)	I _{GSS}	-	-	-1.0 -200	nAdc
Gate Source Cutoff Voltage (V _{DS} = 15 Vdc, I _D = 10 nAdc)	V _{GS(off)}	-0.5	-	-6.0	Vdc
Gate Source Voltage (V _{DS} = 15 Vdc, I _D = 100 μAdc)	V _{GS}	-	-2.5	-	Vdc
ON CHARACTERISTICS					
Zero-Gate-Voltage Drain Current (Note 2) (V _{DS} = 15 Vdc, V _{GS} = 0)	I _{DSS}	1.0	-	5.0	mAdc
SMALL-SIGNAL CHARACTERISTICS					
Forward Transfer Admittance (Note 2) (V _{DS} = 15 Vdc, V _{GS} = 0, f = 1.0 kHz)	Y _{fs}	1000	-	5000	μmhos
Output Common Source Admittance (V _{DS} = 15 Vdc, V _{GS} = 0, f = 1.0 kHz)	y _{os}	-	10	50	μmhos
Input Capacitance (V _{DS} = 15 Vdc, V _{GS} = 0, f = 1.0 MHz)	C _{iss}	-	4.5	7.0	pF
Reverse Transfer Capacitance (V _{DS} = 15 Vdc, V _{GS} = 0, f = 1.0 MHz)	C _{rss}	-	1.5	3.0	pF

2. Pulse Test: Pulse Width ≤ 630 ms, Duty Cycle ≤ 10%.

MMBF5457LT1

TYPICAL CHARACTERISTICS

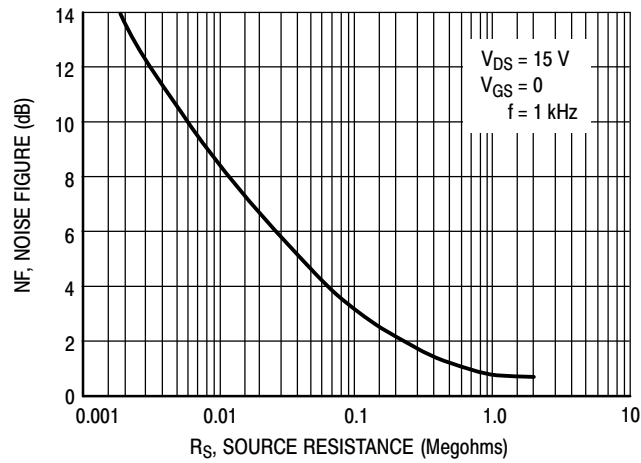

Figure 1. Noise Figure versus Source Resistance

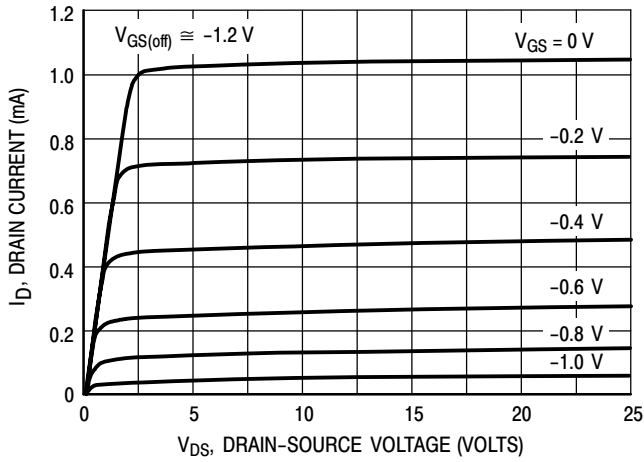

Figure 2. Typical Drain Characteristics

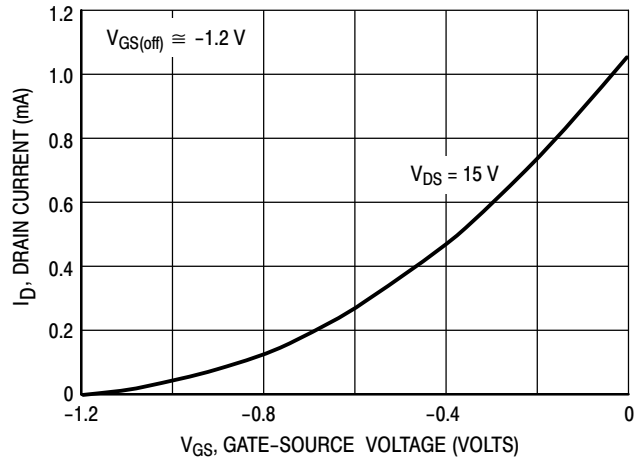

Figure 3. Common Source Transfer Characteristics

MMBF5457LT1

TYPICAL CHARACTERISTICS

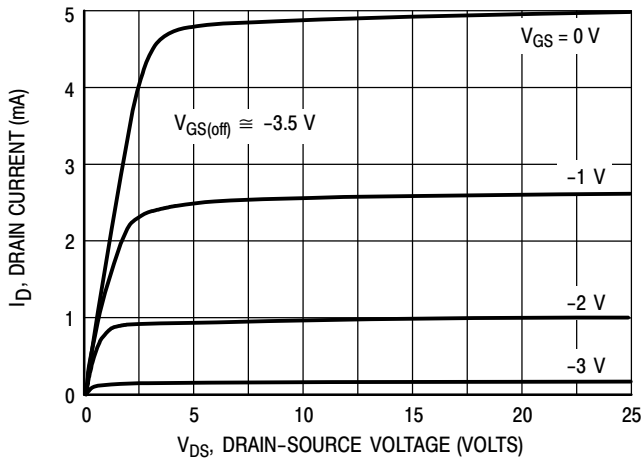

Figure 4. Typical Drain Characteristics

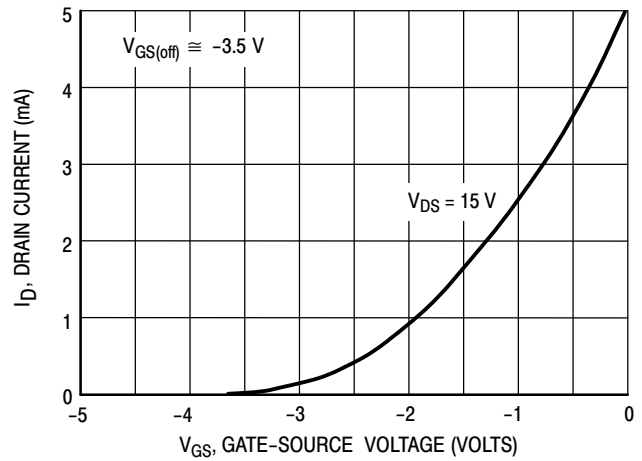

Figure 5. Common Source Transfer Characteristics

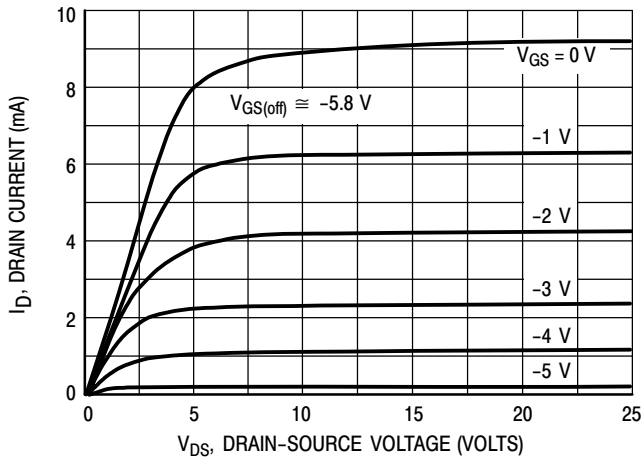

Figure 6. Typical Drain Characteristics

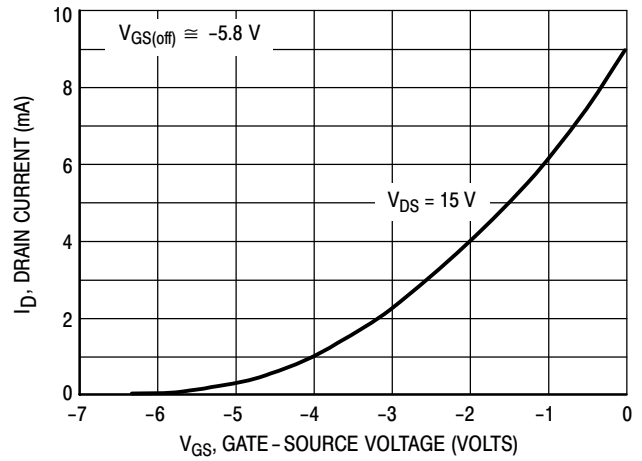

Figure 7. Common Source Transfer Characteristics

Note: Graphical data is presented for dc conditions. Tabular data is given for pulsed conditions (Pulse Width = 630 ms, Duty Cycle = 10%). Under dc conditions, self heating in higher I_{DSS} units reduces I_{DSS} .

MMBF5457LT1

PACKAGE DIMENSIONS

SOT-23 (TO-236)
CASE 318-08
ISSUE AL

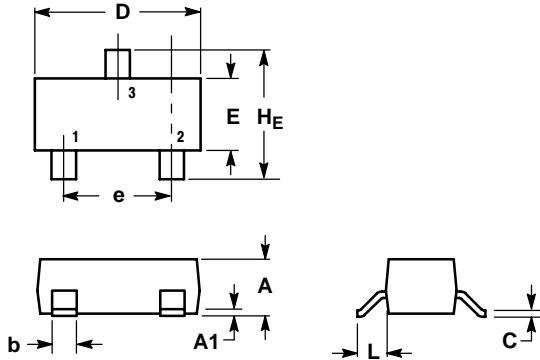

NOTES:

1. DIMENSIONING AND TOLERANCING PER ANSI Y14.5M, 1982.
2. CONTROLLING DIMENSION: INCH.
3. MAXIMUM LEAD THICKNESS INCLUDES LEAD FINISH THICKNESS. MINIMUM LEAD THICKNESS IS THE MINIMUM THICKNESS OF BASE MATERIAL.
4. 318-01 THRU -07 AND -09 OBSOLETE, NEW STANDARD 318-08.

DIM	MILLIMETERS			INCHES		
	MIN	NOM	MAX	MIN	NOM	MAX
A	0.89	1.00	1.11	0.035	0.040	0.044
A1	0.01	0.06	0.10	0.001	0.002	0.004
b	0.37	0.44	0.50	0.015	0.018	0.020
c	0.09	0.13	0.18	0.003	0.005	0.007
D	2.80	2.90	3.04	0.110	0.114	0.120
E	1.20	1.30	1.40	0.047	0.051	0.055
e	1.78	1.90	2.04	0.070	0.075	0.081
L	0.35	0.54	0.69	0.014	0.021	0.029
HE	2.10	2.40	2.64	0.083	0.094	0.104

STYLE 10:

- PIN 1. DRAIN
2. SOURCE
3. GATE

SOLDERING FOOTPRINT*

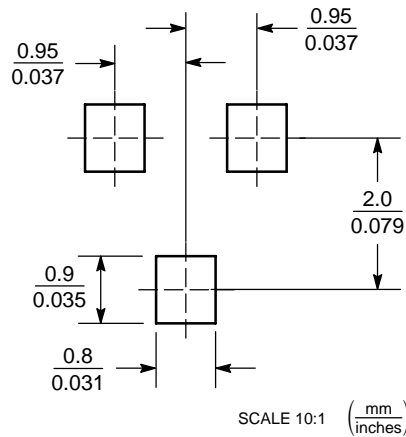

*For additional information on our Pb-Free strategy and soldering details, please download the ON Semiconductor Soldering and Mounting Techniques Reference Manual, SOLDERRM/D.

MMBF5457LT1

ON Semiconductor and **ON** are registered trademarks of Semiconductor Components Industries, LLC (SCILLC). SCILLC reserves the right to make changes without further notice to any products herein. SCILLC makes no warranty, representation or guarantee regarding the suitability of its products for any particular purpose, nor does SCILLC assume any liability arising out of the application or use of any product or circuit, and specifically disclaims any and all liability, including without limitation special, consequential or incidental damages. "Typical" parameters which may be provided in SCILLC data sheets and/or specifications can and do vary in different applications and actual performance may vary over time. All operating parameters, including "Typicals" must be validated for each customer application by customer's technical experts. SCILLC does not convey any license under its patent rights nor the rights of others. SCILLC products are not designed, intended, or authorized for use as components in systems intended for surgical implant into the body, or other applications intended to support or sustain life, or for any other application in which the failure of the SCILLC product could create a situation where personal injury or death may occur. Should Buyer purchase or use SCILLC products for any such unintended or unauthorized application, Buyer shall indemnify and hold SCILLC and its officers, employees, subsidiaries, affiliates, and distributors harmless against all claims, costs, damages, and expenses, and reasonable attorney fees arising out of, directly or indirectly, any claim of personal injury or death associated with such unintended or unauthorized use, even if such claim alleges that SCILLC was negligent regarding the design or manufacture of the part. SCILLC is an Equal Opportunity/Affirmative Action Employer. This literature is subject to all applicable copyright laws and is not for resale in any manner.

PUBLICATION ORDERING INFORMATION

LITERATURE FULFILLMENT:

Literature Distribution Center for ON Semiconductor
P.O. Box 61312, Phoenix, Arizona 85082-1312 USA
Phone: 480-829-7710 or 800-344-3860 Toll Free USA/Canada
Fax: 480-829-7709 or 800-344-3867 Toll Free USA/Canada
Email: orderlit@onsemi.com

N. American Technical Support: 800-282-9855 Toll Free
USA/Canada

Japan: ON Semiconductor, Japan Customer Focus Center
2-9-1 Kamimeguro, Meguro-ku, Tokyo, Japan 153-0051
Phone: 81-3-5773-3850

ON Semiconductor Website: <http://onsemi.com>

Order Literature: <http://www.onsemi.com/litorder>

For additional information, please contact your
local Sales Representative.

MMBF5457LT1/D