

N-Channel JFETs

J111 SST111
J112 SST112
J113 SST113

PRODUCT SUMMARY				
Part Number	V _{GS(off)} (V)	r _{DS(on)} Max (Ω)	I _{D(off)} Typ (pA)	t _{ON} Typ (ns)
J/SST111	-3 to -10	30	5	4
J/SST112	-1 to -5	50	5	4
J/SST113	≤ -3	100	5	4

FEATURES

- Low On-Resistance: 111 < 30 Ω
- Fast Switching—t_{ON}: 4 ns
- Low Leakage: 5 pA
- Low Capacitance: 3 pF
- Low Insertion Loss

BENEFITS

- Low Error Voltage
- High-Speed Analog Circuit Performance
- Negligible “Off-Error,” Excellent Accuracy
- Good Frequency Response, Low Glitches
- Eliminates Additional Buffering

APPLICATIONS

- Analog Switches
- Choppers
- Sample-and-Hold
- Normally “On” Switches
- Current Limiters

DESCRIPTION

The J/SST111 series consists of all-purpose analog switches designed to support a wide range of applications. The J/SST113 are useful in a high-gain amplifier mode.

For similar products in TO-206AA(TO-18) packaging, see the 2N/PN/SST4391 series, 2N4856A/4857A/4858A, and 2N5564/5565/5566 (duals) data sheets.

The J series, TO-226AA (TO-92) plastic package, provides low cost, while the SST series, TO236 (SOT-23) package, provides surface-mount capability. Both the J and SST series are available in tape-and-reel for automated assembly (see Packaging Information).

TO-226AA (TO-92)

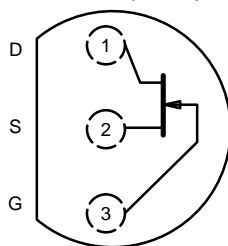

Top View

J111
J112
J113

TO-236 (SOT-23)

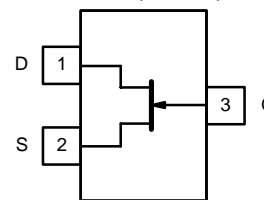

Top View

SST111 (C1)*
SST112 (C2)*
SST113 (C3)*

*Marking Code for TO-236

ABSOLUTE MAXIMUM RATINGS

Gate-Drain, Gate-Source Voltage	-35 V
Gate Current	50 mA
Lead Temperature (1/16" from case for 10 seconds)	300 °C
Storage Temperature	-55 to 150 °C
Operating Junction Temperature	-55 to 150 °C

Power Dissipation ^a	
(TO-236)	350 mW
(TO-226AA)	360 mW

Notes
a. Derate 2.8 mW/°C above 25 °C

For applications information see AN105.



SPECIFICATIONS (T _A = 25 °C UNLESS OTHERWISE NOTED)										
Parameter	Symbol	Test Conditions	Typ ^a	Limits						Unit
				J/SST111		J/SST112		J/SST113		
				Min	Max	Min	Max	Min	Max	
Static										
Gate-Source Breakdown Voltage	V _{(BR)GSS}	I _G = -1 μA, V _{DS} = 0 V	-55	-35		-35		-35		V
Gate-Source Cutoff Voltage	V _{GS(off)}	V _{DS} = 5 V, I _D = 1 μA		-3	-10	-1	-5		-3	
Saturation Drain Current ^b	I _{DSS}	V _{DS} = 15 V, V _{GS} = 0 V		20		5		2		mA
Gate Reverse Current	I _{GSS}	V _{GS} = -15 V, V _{DS} = 0 V	-0.005		-1		-1		-1	nA
		T _A = 125 °C	-3							
Gate Operating Current	I _G	V _{DG} = 15 V, I _D = 10 mA	-5							pA
Drain Cutoff Current	I _{D(off)}	V _{DS} = 5 V, V _{GS} = -10 V	0.005		1		1		1	nA
		T _A = 125 °C	3							
Drain-Source On-Resistance	r _{DS(on)}	V _{GS} = 0 V, V _{DS} = 0.1 V			30		50		100	Ω
Gate-Source Forward Voltage	V _{GS(F)}	I _G = 1 mA, V _{DS} = 0 V	0.7							V
Dynamic										
Common-Source Forward Transconductance	g _{fs}	V _{DS} = 20 V, I _D = 1 mA f = 1 kHz	6							mS
Common-Source Output Conductance	g _{os}		25							μS
Drain-Source On-Resistance	r _{ds(on)}	V _{GS} = 0 V, I _D = 0 mA f = 1 kHz			30		50		100	Ω
Common-Source Input Capacitance	C _{iss}	V _{DS} = 0 V, V _{GS} = -10 V f = 1 MHz	7		12		12		12	pF
Common-Source Reverse Transfer Capacitance	C _{rss}		3		5		5		5	
Equivalent Input Noise Voltage	e _n	V _{DG} = 10 V, I _D = 1 mA f = 1 kHz	3							nV/ √Hz
Switching										
Turn-On Time	t _{d(on)}	V _{DD} = 10 V, V _{GS(H)} = 0 V See Switching Circuit	2							ns
	t _r		2							
Turn-Off Time	t _{d(off)}		6							
	t _f		15							

Notes

- a. Typical values are for DESIGN AID ONLY, not guaranteed nor subject to production testing.
- b. Pulse test: PW ≤ 300 μs duty cycle ≤ 3%.

NCB



TYPICAL CHARACTERISTICS (T_A = 25°C UNLESS OTHERWISE NOTED)

On-Resistance and Drain Current vs. Gate-Source Cutoff Voltage

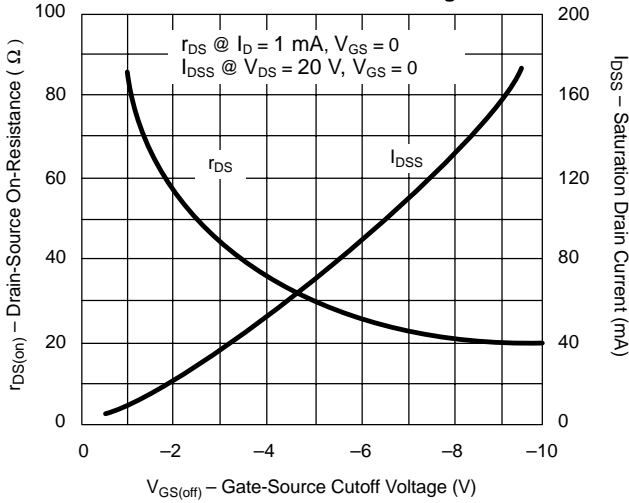

On-Resistance vs. Drain Current

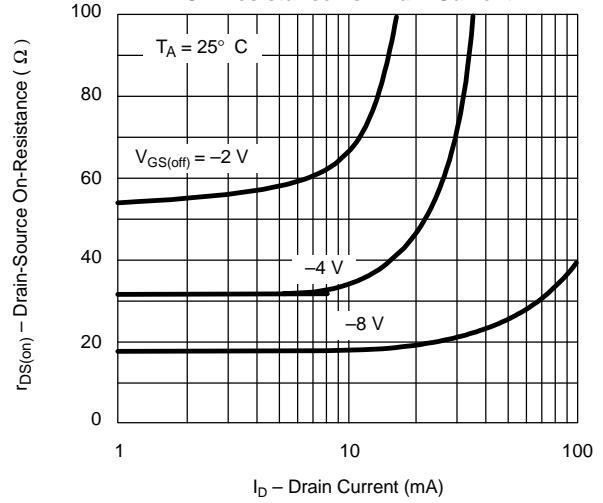

On-Resistance vs. Temperature

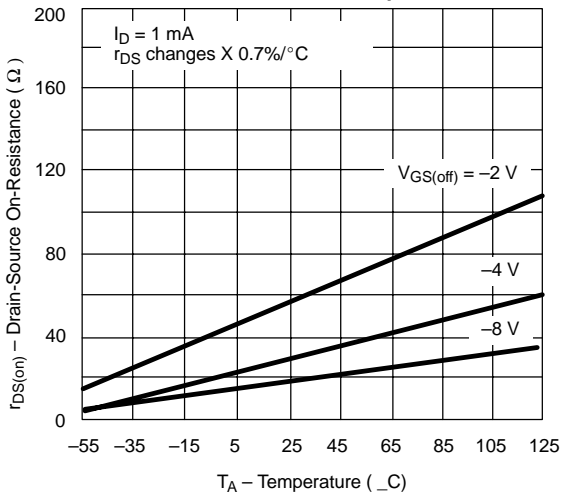

Turn-On Switching

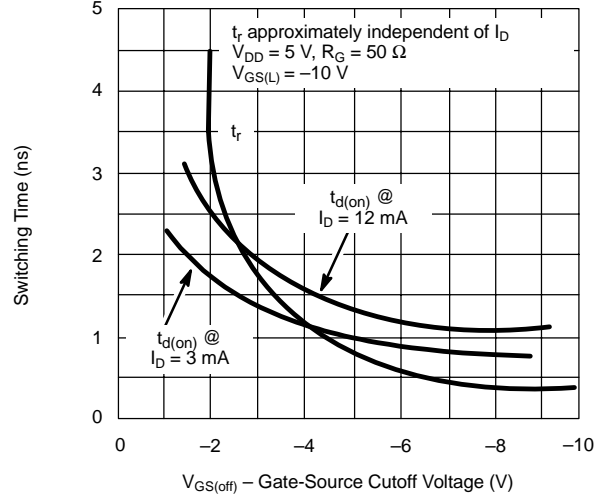

Turn-Off Switching

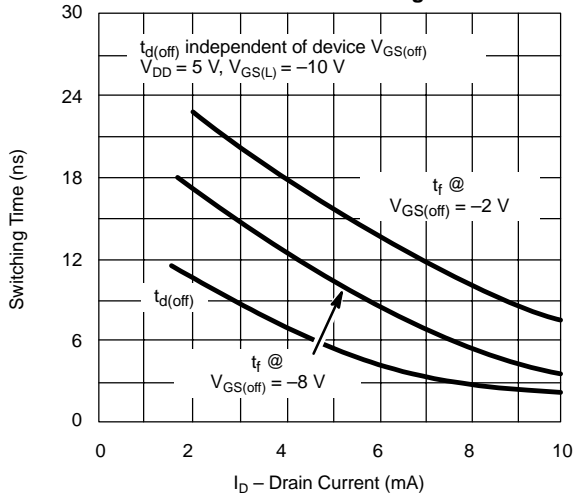

Capacitance vs. Gate-Source Voltage

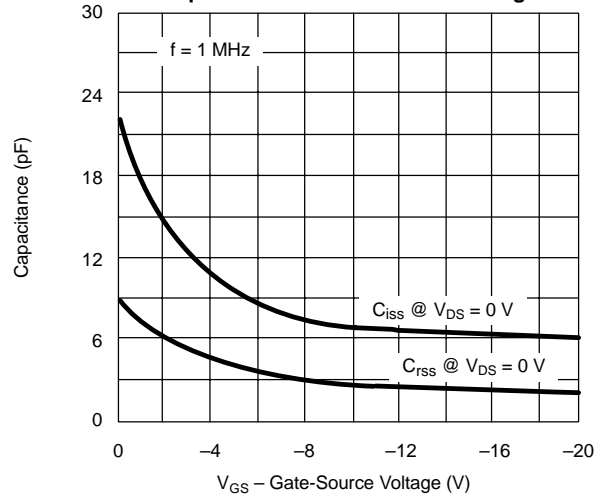

TYPICAL CHARACTERISTICS ($T_A = 25^\circ\text{C}$ UNLESS OTHERWISE NOTED)

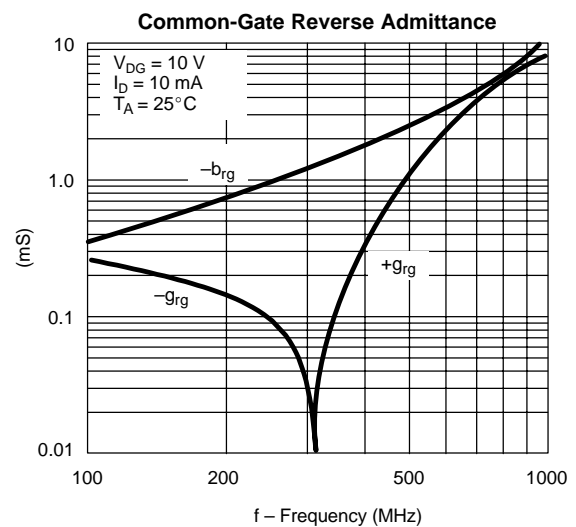
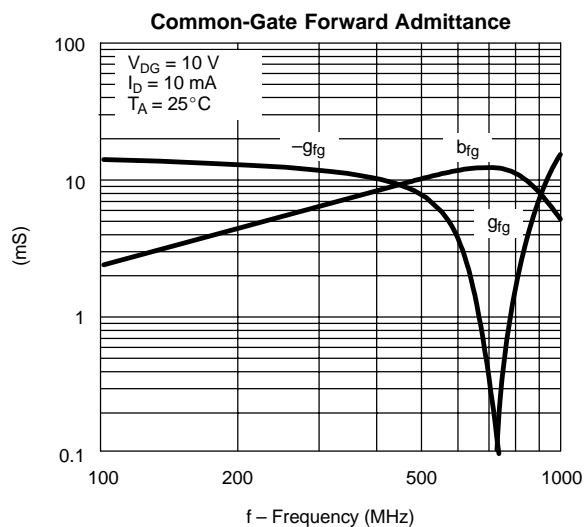
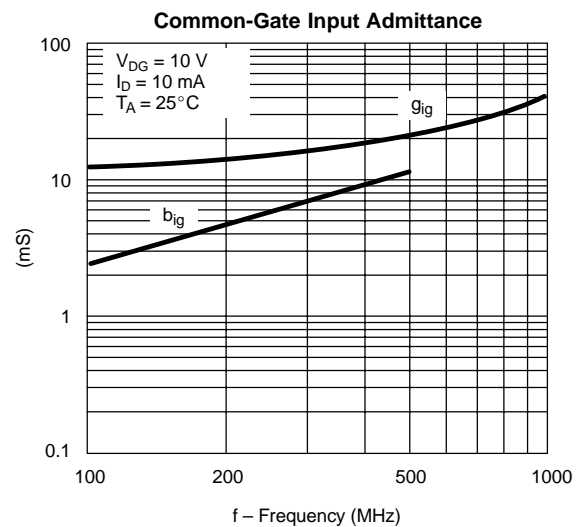
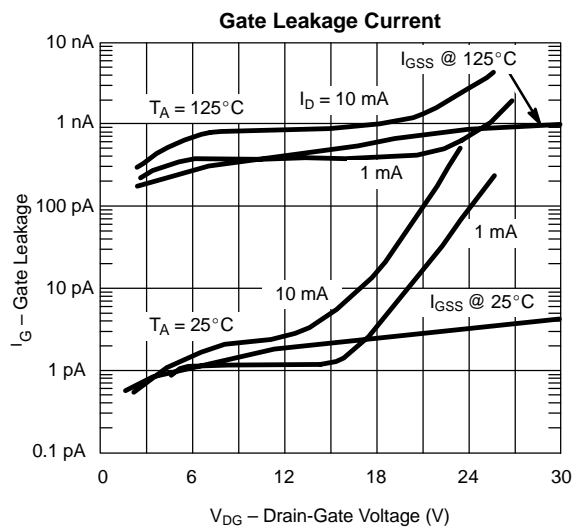
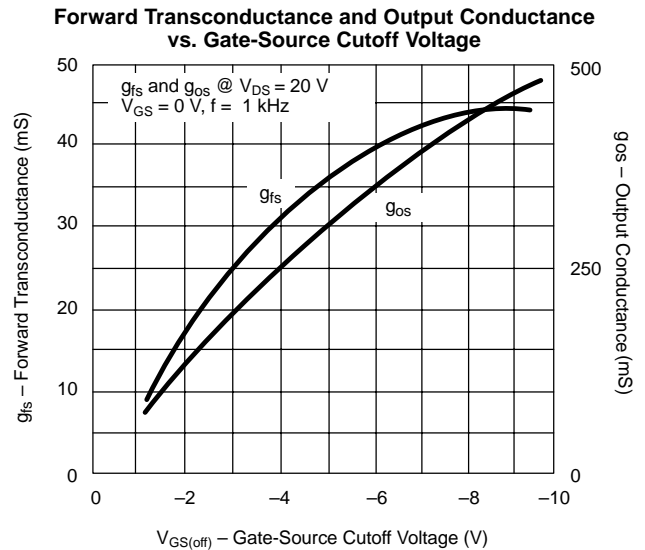
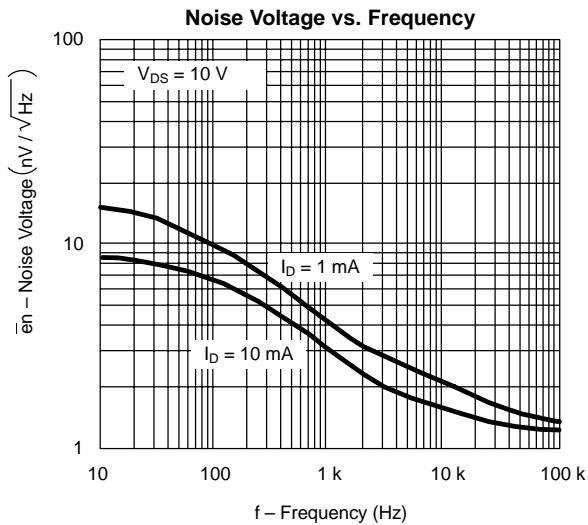

TYPICAL CHARACTERISTICS ($T_A = 25^\circ\text{C}$ UNLESS OTHERWISE NOTED)

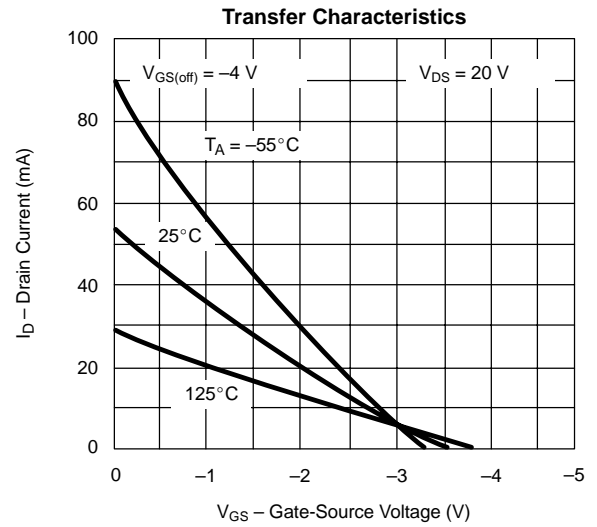
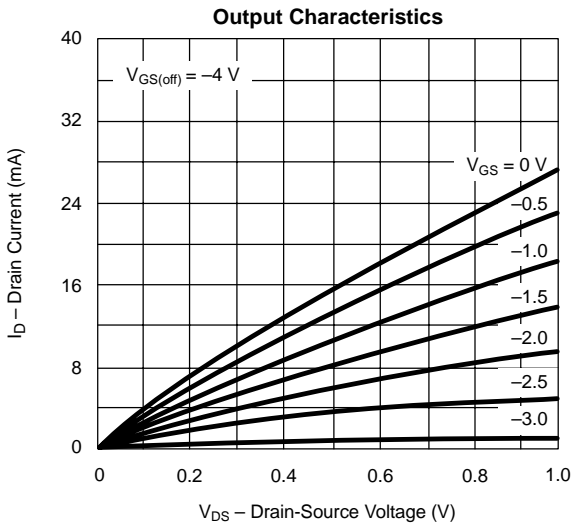
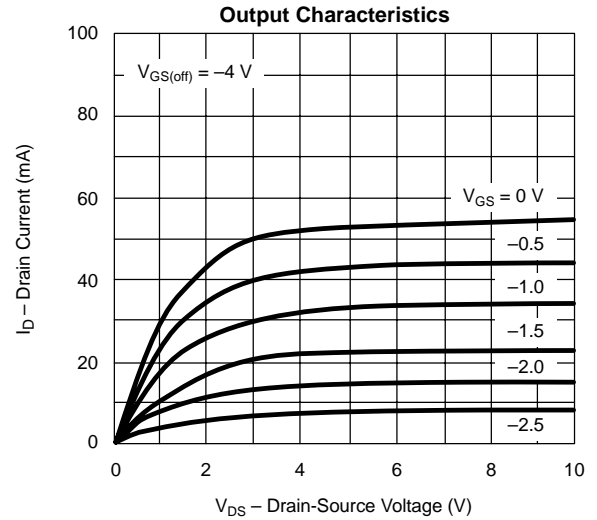
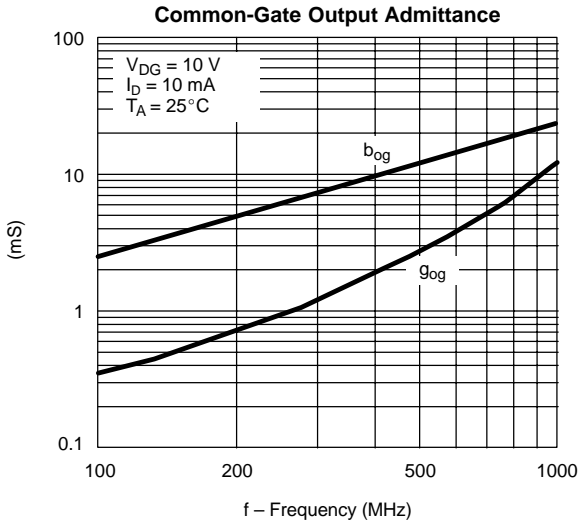

SWITCHING TIME TEST CIRCUIT			
	J/SST111	J/SST112	J/SST113
$V_{GS(L)}$	-12 V	-7 V	-5 V
R_L^*	800 Ω	1600 Ω	3200 Ω
$I_{D(on)}$	12 mA	6 mA	3 mA

*Non-inductive

INPUT PULSE

Rise Time < 1 ns
Fall Time < 1 ns
Pulse Width 100 ns
PRF 1 MHz

SAMPLING SCOPE

Rise Time 0.4 ns
Input Resistance 10 M Ω
Input Capacitance 1.5 pF

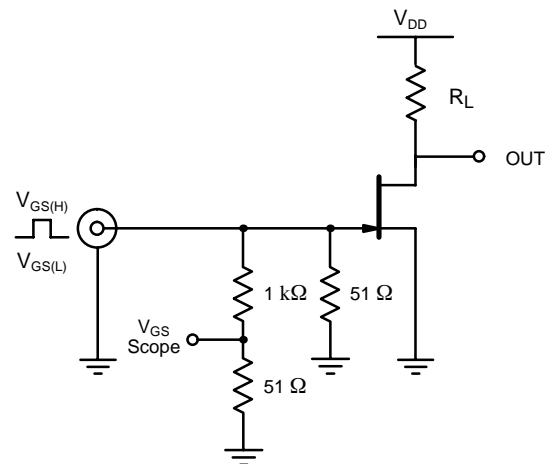



Disclaimer

All product specifications and data are subject to change without notice.

Vishay Intertechnology, Inc., its affiliates, agents, and employees, and all persons acting on its or their behalf (collectively, "Vishay"), disclaim any and all liability for any errors, inaccuracies or incompleteness contained herein or in any other disclosure relating to any product.

Vishay disclaims any and all liability arising out of the use or application of any product described herein or of any information provided herein to the maximum extent permitted by law. The product specifications do not expand or otherwise modify Vishay's terms and conditions of purchase, including but not limited to the warranty expressed therein, which apply to these products.

No license, express or implied, by estoppel or otherwise, to any intellectual property rights is granted by this document or by any conduct of Vishay.

The products shown herein are not designed for use in medical, life-saving, or life-sustaining applications unless otherwise expressly indicated. Customers using or selling Vishay products not expressly indicated for use in such applications do so entirely at their own risk and agree to fully indemnify Vishay for any damages arising or resulting from such use or sale. Please contact authorized Vishay personnel to obtain written terms and conditions regarding products designed for such applications.

Product names and markings noted herein may be trademarks of their respective owners.