

HIGH VOLTAGE MEDIUM CURRENT DRIVER ARRAYS

DESCRIPTION

The SG2000 series integrates seven NPN Darlington pairs with internal suppression diodes to drive lamps, relays, and solenoids in many military, aerospace, and industrial applications that require severe environments. All units feature open collector outputs with greater than 50V breakdown voltages combined with 500mA current carrying capabilities. Five different input configurations provide optimized designs for interfacing with DTL, TTL, PMOS, or CMOS drive signals. These devices are designed to operate from -55°C to 125°C ambient temperature in a 16 pin dual in line ceramic (J) package and 20 pin Leadless Chip Carrier (LCC). The plastic dual in-line (N) is designed to operate over the commercial temperature range of 0°C to 70°C.

FEATURES

- Seven npn Darlington pairs
- -55°C to 125°C ambient operating temperature range
- Collector currents to 600mA
- Output voltages from 50V to 95V
- Internal clamping diodes for inductive loads
- DTL, TTL, PMOS, or CMOS compatible inputs
- Hermetic ceramic package

HIGH RELIABILITY FEATURES

- ◆ Available to MIL-STD-883 and DESC SMD
- ◆ MIL-M38510/14101BEA - JAN2001J
- ◆ MIL-M38510/14102BEA - JAN2002J
- ◆ MIL-M38510/14103BEA - JAN2003J
- ◆ MIL-M38510/14104BEA - JAN2004J
- ◆ Radiation data available
- ◆ LMI level "S" processing available

PARTIAL SCHEMATICS

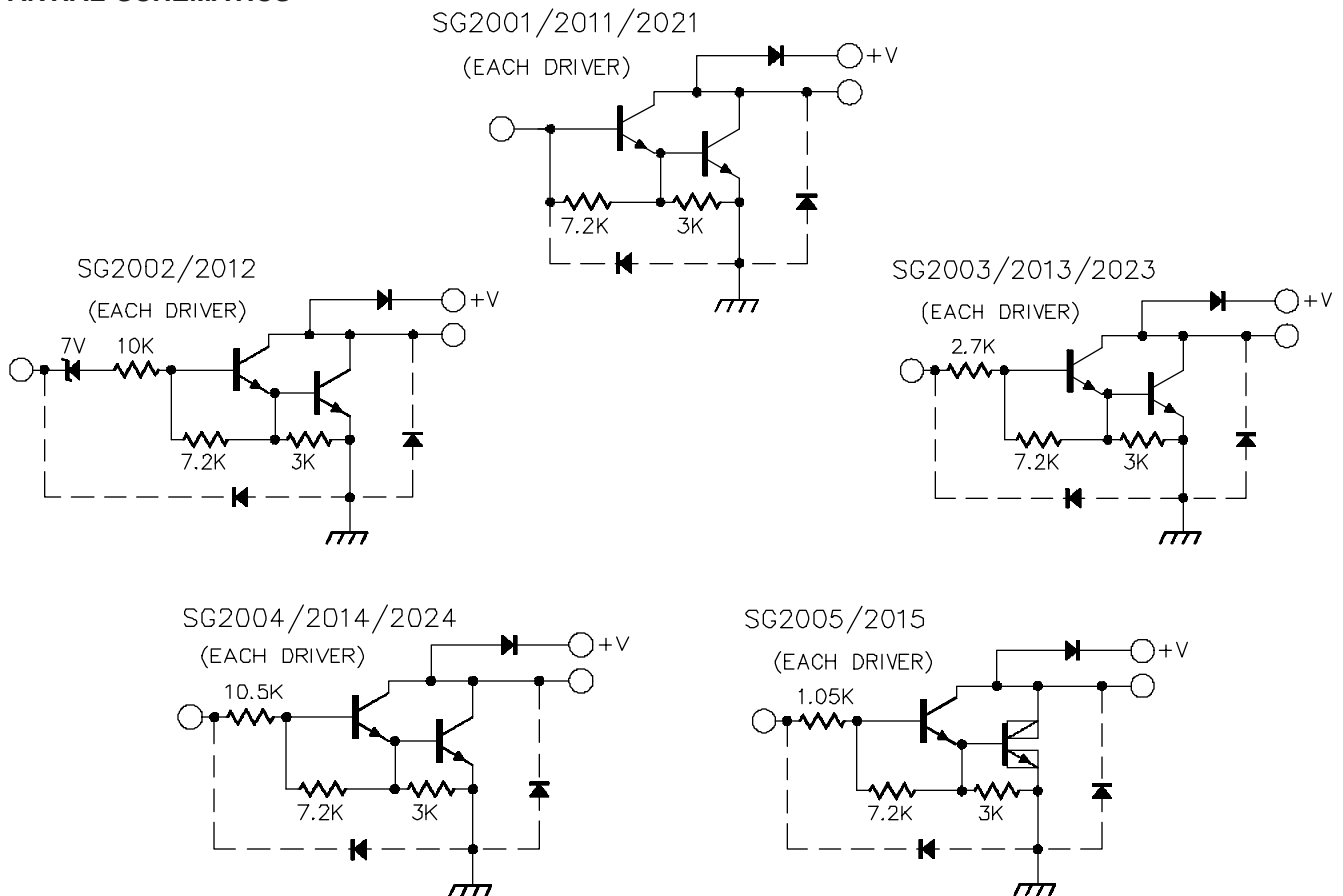

ABSOLUTE MAXIMUM RATINGS (Note 1)

Output Voltage, V_{CE} (SG2000, 2010 series)	50V
(SG2020 series)	95V
Input Voltage, V_{IN} (SG2002,3,4)	30V
Continuous Input Current, I_{IN}	25mA

Peak Collector Current, I_C (SG2000, 2020)	500mA
(SG2010)	600mA
Operating Junction Temperature Hermetic (J, L Packages)	150°C
Plastic (N, Packages)	150°C
Storage Temperature Range	-65°C to 150°C
Lead Temperature (Soldering 10 sec.)	300°C
RoHS Peak Package Solder Reflow Temp. (40 sec. max. exp.).....	260°C (+0, -5)

Note 1. Values beyond which damage may occur.

THERMAL DATA

J Package:

Thermal Resistance-Junction to Case, θ_{JC}	30°C/W
Thermal Resistance-Junction to Ambient, θ_{JA}	80°C/W

N Package:

Thermal Resistance-Junction to Case, θ_{JC}	40°C/W
Thermal Resistance-Junction to Ambient, θ_{JA}	65°C/W

L Package:

Thermal Resistance-Junction to Case, θ_{JC}	35°C/W
Thermal Resistance-Junction to Ambient, θ_{JA}	120°C/W

Note A. Junction Temperature Calculation: $T_J = T_A + (P_D \times \theta_{JA})$.

Note B. The above numbers for θ_{JC} are maximums for the limiting thermal resistance of the package in a standard mounting configuration. The θ_{JA} numbers are meant to be guidelines for the thermal performance of the device/pc-board system. All of the above assume no ambient airflow.

RECOMMENDED OPERATING CONDITIONS (Note 2)

Output Voltage, V_{CE} SG2000, SG2010 series	50V
SG2020 series	95V

Peak Collector Current, I_C SG2000, SG2020 series	50mA
SG2010 series	500mA
Operating Ambient Temperature Range SG2000 Series - Hermetic	-55°C to 125°C
SG2000 Series - Plastic	0°C to 70°C

Note 2. Range over which the device is functional.

SELECTION GUIDE

Device	V_{CE} Max	I_C Max	Logic Inputs
SG2001	50V	500mA	General Purpose PMOS, CMOS
SG2002	50V	500mA	14V-25V PMOS
SG2003	50V	500mA	5V TTL, CMOS
SG2004	50V	500mA	6V-15V CMOS, PMOS
SG2011	50V	600mA	General Purpose PMOS, CMOS
SG2012	50V	600mA	14V-25V PMOS

Device	V_{CE} Max	I_C Max	Logic Inputs
SG2013	50V	600mA	5V TTL, CMOS
SG2014	50V	600mA	6V-15V CMOS, PMOS
SG2015	50V	600mA	High Output TTL
SG2021	95V	500mA	General Purpose PMOS, CMOS
SG2023	95V	500mA	5V TTL, CMOS
SG2024	95V	500mA	6V-15V CMOS, PMOS

ELECTRICAL CHARACTERISTICS

(Unless otherwise specified, these specifications apply over the operating ambient temperatures for SG2000 series - Hermetic - with $-55^{\circ}\text{C} \leq T_A \leq 125^{\circ}\text{C}$ and SG2000 series - Plastic - with $0^{\circ}\text{C} \leq T_A \leq 70^{\circ}\text{C}$. Low duty cycle pulse testing techniques are used which maintains junction and case temperatures equal to the ambient temperature.)

SG2001 thru SG2004

Parameter	Applicable Devices	Temp.	Test Conditions	Limits			Units
				Min.	Typ.	Max.	
Output Leakage Current (I_{CEX})	All		$V_{\text{CE}} = 50\text{V}$			100	μA
	SG2002		$V_{\text{CE}} = 50\text{V}, V_{\text{IN}} = 6\text{V}$			500	μA
	SG2004		$V_{\text{CE}} = 50\text{V}, V_{\text{IN}} = 1\text{V}$			500	μA
Collector - Emitter ($V_{\text{CE(SAT)}}$)	All	$T_A = T_{\text{MIN}}$	$I_C = 350\text{mA}, I_B = 850\mu\text{A}$		1.6	1.8	V
		$T_A = T_{\text{MIN}}$	$I_C = 200\text{mA}, I_B = 550\mu\text{A}$		1.3	1.5	V
		$T_A = T_{\text{MIN}}$	$I_C = 100\text{mA}, I_B = 350\mu\text{A}$		1.1	1.3	V
		$T_A = 25^{\circ}\text{C}$	$I_C = 350\text{mA}, I_B = 500\mu\text{A}$		1.25	1.6	V
		$T_A = 25^{\circ}\text{C}$	$I_C = 200\text{mA}, I_B = 350\mu\text{A}$		1.1	1.3	V
		$T_A = 25^{\circ}\text{C}$	$I_C = 100\text{mA}, I_B = 250\mu\text{A}$		0.9	1.1	V
		$T_A = T_{\text{MAX}}$	$I_C = 350\text{mA}, I_B = 500\mu\text{A}$		1.6	1.8	V
		$T_A = T_{\text{MAX}}$	$I_C = 200\text{mA}, I_B = 350\mu\text{A}$		1.3	1.5	V
		$T_A = T_{\text{MAX}}$	$I_C = 100\text{mA}, I_B = 250\mu\text{A}$		1.1	1.3	V
Input Current ($I_{\text{IN(ON)}}$)	SG2002		$V_{\text{IN}} = 17\text{V}$	480	850	1300	μA
	SG2003		$V_{\text{IN}} = 3.85\text{V}$	650	930	1350	μA
	SG2004		$V_{\text{IN}} = 5\text{V}$	240	350	500	μA
$I_{\text{IN(OFF)}}$	All		$V_{\text{IN}} = 12\text{V}$	650	1000	1450	μA
			$I_C = 500\mu\text{A}$	25	50		μA
Input Voltage ($V_{\text{IN(ON)}}$)	SG2002	$T_A = T_{\text{MAX}}$	$V_{\text{CE}} = 2\text{V}, I_C = 300\text{mA}$			18	V
		$T_A = T_{\text{MIN}}$	$V_{\text{CE}} = 2\text{V}, I_C = 300\text{mA}$			13	V
		$T_A = T_{\text{MAX}}$	$V_{\text{CE}} = 2\text{V}, I_C = 200\text{mA}$			3.3	V
	SG2003	$T_A = T_{\text{MIN}}$	$V_{\text{CE}} = 2\text{V}, I_C = 250\text{mA}$			3.6	V
		$T_A = T_{\text{MIN}}$	$V_{\text{CE}} = 2\text{V}, I_C = 300\text{mA}$			3.9	V
		$T_A = T_{\text{MIN}}$	$V_{\text{CE}} = 2\text{V}, I_C = 200\text{mA}$			2.4	V
	SG2004	$T_A = T_{\text{MAX}}$	$V_{\text{CE}} = 2\text{V}, I_C = 250\text{mA}$			2.7	V
		$T_A = T_{\text{MAX}}$	$V_{\text{CE}} = 2\text{V}, I_C = 300\text{mA}$			3.0	V
		$T_A = T_{\text{MIN}}$	$V_{\text{CE}} = 2\text{V}, I_C = 125\text{mA}$			6.0	V
		$T_A = T_{\text{MIN}}$	$V_{\text{CE}} = 2\text{V}, I_C = 200\text{mA}$			8.0	V
		$T_A = T_{\text{MIN}}$	$V_{\text{CE}} = 2\text{V}, I_C = 275\text{mA}$			10	V
		$T_A = T_{\text{MIN}}$	$V_{\text{CE}} = 2\text{V}, I_C = 350\text{mA}$			12	V
		$T_A = T_{\text{MAX}}$	$V_{\text{CE}} = 2\text{V}, I_C = 125\text{mA}$			5.0	V
		$T_A = T_{\text{MAX}}$	$V_{\text{CE}} = 2\text{V}, I_C = 200\text{mA}$			6.0	V
		$T_A = T_{\text{MAX}}$	$V_{\text{CE}} = 2\text{V}, I_C = 275\text{mA}$			7.0	V
D-C Forward Current Transfer Ratio (h_{FE})	SG2001	$T_A = T_{\text{MAX}}$	$V_{\text{CE}} = 2\text{V}, I_C = 350\text{mA}$	500			
		$T_A = T_{\text{MIN}}$	$V_{\text{CE}} = 2\text{V}, I_C = 350\text{mA}$	1000			
		$T_A = 25^{\circ}\text{C}$	$V_{\text{CE}} = 2\text{V}, I_C = 350\text{mA}$				
Input Capacitance (C_{IN}) (Note 3)	All	$T_A = 25^{\circ}\text{C}$			15	25	pF
Turn-On Delay (TPLH)	All	$T_A = 25^{\circ}\text{C}$	$0.5 E_{\text{IN}}$ to $0.5 E_{\text{OUT}}$	250	1000		ns
Turn-Off Delay (TPHL)	All	$T_A = 25^{\circ}\text{C}$	$0.5 E_{\text{IN}}$ to $0.5 E_{\text{OUT}}$	250	1000		ns
Clamp Diode Leakage Current (I_{R})	All		$V_{\text{R}} = 50\text{V}$			50	μA
Clamp Diode Forward Voltage (V_{F})	All		$I_{\text{F}} = 350\text{mA}$		1.7	2.0	V

Note 3. These parameters, although guaranteed, are not tested in production.

ELECTRICAL CHARTACTERISTICS (continued)

SG2011 thru SG2015

Parameter	Applicable Devices	Temp.	Test Conditions	Limits			Units	
				Min.	Typ.	Max.		
Output Leakage Current (I_{CEX})	All		$V_{CE} = 50V$			100	μA	
	SG2012		$V_{CE} = 50V, V_{IN} = 6V$			500	μA	
	SG2014		$V_{CE} = 50V, V_{IN} = 1V$			500	μA	
Collector - Emitter ($V_{CE(SAT)}$)	All	$T_A = T_{MIN}$	$I_C = 500mA, I_B = 1100\mu A$		1.8	2.1	V	
		$T_A = T_{MIN}$	$I_C = 350mA, I_B = 850\mu A$		1.6	1.8	V	
		$T_A = T_{MIN}$	$I_C = 200mA, I_B = 550\mu A$		1.3	1.5	V	
		$T_A = 25^\circ C$	$I_C = 500mA, I_B = 600\mu A$		1.7	1.9	V	
		$T_A = 25^\circ C$	$I_C = 350mA, I_B = 500\mu A$		1.25	1.6	V	
		$T_A = 25^\circ C$	$I_C = 200mA, I_B = 350\mu A$		1.1	1.3	V	
		$T_A = T_{MAX}$	$I_C = 500mA, I_B = 600\mu A$		1.8	2.1	V	
		$T_A = T_{MAX}$	$I_C = 350mA, I_B = 500\mu A$		1.6	1.8	V	
		$T_A = T_{MAX}$	$I_C = 200mA, I_B = 350\mu A$		1.3	1.5	V	
Input Current ($I_{IN(ON)}$)	SG2012		$V_{IN} = 17V$	480	850	1300	μA	
	SG2013		$V_{IN} = 3.85V$	650	930	1350	μA	
	SG2014		$V_{IN} = 5V$	240	350	500	μA	
	SG2015		$V_{IN} = 12V$	650	1000	1450	μA	
			$V_{IN} = 3V$	1180	1500	2400	μA	
Input Voltage ($V_{IN(OFF)}$) ($V_{IN(ON)}$)	All	$T_A = T_{MAX}$	$I_C = 500\mu A$	25	50		μA	
	SG2012	$T_A = T_{MIN}$	$V_{CE} = 2V, I_C = 500mA$			23.5	V	
		$T_A = T_{MAX}$	$V_{CE} = 2V, I_C = 500mA$			17	V	
		SG2013	$T_A = T_{MIN}$	$V_{CE} = 2V, I_C = 250mA$			3.6	V
			$T_A = T_{MIN}$	$V_{CE} = 2V, I_C = 300mA$			3.9	V
	SG2014	$T_A = T_{MIN}$	$V_{CE} = 2V, I_C = 500mA$			6.0	V	
		$T_A = T_{MAX}$	$V_{CE} = 2V, I_C = 250mA$			2.7	V	
		$T_A = T_{MAX}$	$V_{CE} = 2V, I_C = 300mA$			3.0	V	
		$T_A = T_{MAX}$	$V_{CE} = 2V, I_C = 500mA$			3.5	V	
		$T_A = T_{MIN}$	$V_{CE} = 2V, I_C = 275mA$			10	V	
		$T_A = T_{MIN}$	$V_{CE} = 2V, I_C = 350mA$			12	V	
		$T_A = T_{MIN}$	$V_{CE} = 2V, I_C = 500mA$			17	V	
		$T_A = T_{MAX}$	$V_{CE} = 2V, I_C = 275mA$			7.0	V	
	SG2015	$T_A = T_{MAX}$	$V_{CE} = 2V, I_C = 350mA$			8.0	V	
		$T_A = T_{MAX}$	$V_{CE} = 2V, I_C = 500mA$			9.5	V	
		$T_A = T_{MIN}$	$V_{CE} = 2V, I_C = 350mA$			3.0	V	
		$T_A = T_{MIN}$	$V_{CE} = 2V, I_C = 500mA$			3.5	V	
		$T_A = T_{MAX}$	$V_{CE} = 2V, I_C = 350mA$			2.4	V	
		$T_A = T_{MAX}$	$V_{CE} = 2V, I_C = 500mA$			2.6	V	
	D-C Forward Current	SG2011	$T_A = T_{MIN}$	$V_{CE} = 2V, I_C = 500mA$	450			
Transfer Ratio (h_{FE})		$T_A = 25^\circ C$	$V_{CE} = 2V, I_C = 500mA$	900				
Input Capacitance (C_{IN}) (Note 3)	All	$T_A = 25^\circ C$			15	25	pF	
Turn-On Delay (TPLH)	All	$T_A = 25^\circ C$	$0.5 E_{IN}$ to $0.5 E_{OUT}$		250	1000	ns	
Turn-Off Delay (TPHL)	All	$T_A = 25^\circ C$	$0.5 E_{IN}$ to $0.5 E_{OUT}$		250	1000	ns	
Clamp Diode Leakage Current (I_R)	All		$V_R = 50V$			50	μA	
Clamp Diode Forward Voltage (V_F)	All		$I_F = 350mA$		1.7	2.0	V	
			$I_F = 500mA$			2.5	V	

Note 3. These parameters, although guaranteed, are not tested in production.

ELECTRICAL CHARACTERISTICS (continued)

SG2021 thru SG2024

Parameter	Applicable Devices	Temp.	Test Conditions	Limits			Units
				Min.	Typ.	Max.	
Output Leakage Current (I_{CEX})	All		$V_{CE} = 95V$			100	μA
	SG2024		$V_{CE} = 95V, V_{IN} = 1V$			500	μA
Collector - Emitter ($V_{CE(SAT)}$)	All	$T_A = T_{MIN}$	$I_C = 350mA, I_B = 850\mu A$		1.6	1.8	V
		$T_A = T_{MIN}$	$I_C = 200mA, I_B = 550\mu A$		1.3	1.5	V
		$T_A = T_{MIN}$	$I_C = 100mA, I_B = 350\mu A$		1.1	1.3	V
		$T_A = 25^\circ C$	$I_C = 350mA, I_B = 500\mu A$		1.25	1.6	V
		$T_A = 25^\circ C$	$I_C = 200mA, I_B = 350\mu A$		1.1	1.3	V
		$T_A = 25^\circ C$	$I_C = 100mA, I_B = 250\mu A$		0.9	1.1	V
		$T_A = T_{MAX}$	$I_C = 350mA, I_B = 500\mu A$		1.6	1.8	V
		$T_A = T_{MAX}$	$I_C = 200mA, I_B = 350\mu A$		1.3	1.5	V
		$T_A = T_{MAX}$	$I_C = 100mA, I_B = 250\mu A$		1.1	1.3	V
Input Current ($I_{IN(ON)}$)	SG2023		$V_{IN} = 3.85V$	650	930	1350	μA
	SG2024		$V_{IN} = 5V$	240	350	500	μA
			$V_{IN} = 12V$	650	1000	1450	μA
$(I_{IN(OFF)})$	All	$T_A = T_{MAX}$	$I_C = 500\mu A$	25	50		μA
Input Voltage ($V_{IN(ON)}$)		$T_A = T_{MAX}$	$V_{CE} = 2V, I_C = 300mA$			13	V
	SG2023	$T_A = T_{MIN}$	$V_{CE} = 2V, I_C = 200mA$			3.3	V
		$T_A = T_{MIN}$	$V_{CE} = 2V, I_C = 250mA$			3.6	V
		$T_A = T_{MIN}$	$V_{CE} = 2V, I_C = 300mA$			3.9	V
		$T_A = T_{MIN}$	$V_{CE} = 2V, I_C = 200mA$			2.4	V
		$T_A = T_{MAX}$	$V_{CE} = 2V, I_C = 250mA$			2.7	V
		$T_A = T_{MAX}$	$V_{CE} = 2V, I_C = 300mA$			3.0	V
	SG2024	$T_A = T_{MIN}$	$V_{CE} = 2V, I_C = 125mA$			6.0	V
		$T_A = T_{MIN}$	$V_{CE} = 2V, I_C = 200mA$			8.0	V
		$T_A = T_{MIN}$	$V_{CE} = 2V, I_C = 275mA$			10	V
		$T_A = T_{MIN}$	$V_{CE} = 2V, I_C = 350mA$			12	V
		$T_A = T_{MAX}$	$V_{CE} = 2V, I_C = 125mA$			5.0	V
		$T_A = T_{MAX}$	$V_{CE} = 2V, I_C = 200mA$			6.0	V
		$T_A = T_{MAX}$	$V_{CE} = 2V, I_C = 275mA$			7.0	V
		$T_A = T_{MAX}$	$V_{CE} = 2V, I_C = 350mA$			8.0	V
D-C Forward Current	SG2021	$T_A = T_{MIN}$	$V_{CE} = 2V, I_C = 350mA$	500			
Transfer Ratio (h_{FE})		$T_A = 25^\circ C$	$V_{CE} = 2V, I_C = 350mA$	1000			
Input Capacitance (C_{IN}) (Note 3)	All	$T_A = 25^\circ C$			15	25	pF
Turn-On Delay (TPLH)	All	$T_A = 25^\circ C$	$0.5 E_{IN}$ to $0.5 E_{OUT}$		250	1000	ns
Turn-Off Delay (TPHL)	All	$T_A = 25^\circ C$	$0.5 E_{IN}$ to $0.5 E_{OUT}$		250	1000	ns
Clamp Diode Leakage Current (I_R)	All		$V_R = 95V$			50	μA
Clamp Diode Forward Voltage (V_F)	All		$I_F = 350mA$		1.7	2.0	V

Note 3. These parameters, although guaranteed, are not tested in production.

CHARACTERISTIC CURVES

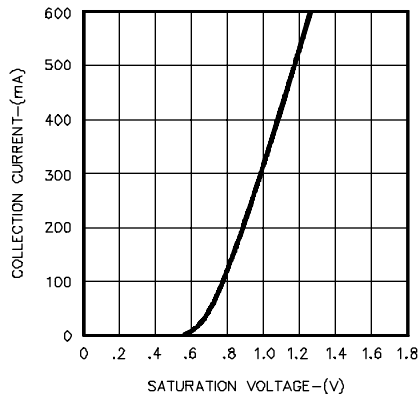

FIGURE 1. OUTPUT CHARACTERISTICS

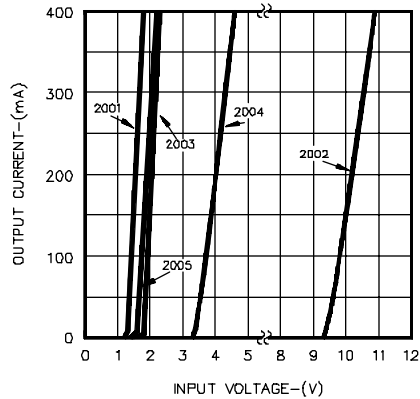

FIGURE 2. OUTPUT CURRENT VS. INPUT VOLTAGE

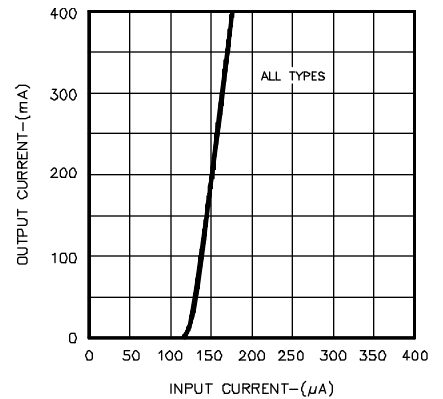

FIGURE 3. OUTPUT CURRENT VS. INPUT CURRENT

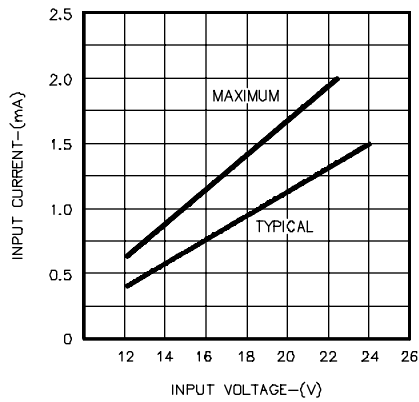

FIGURE 4. INPUT CHARACTERISTICS - SG2002

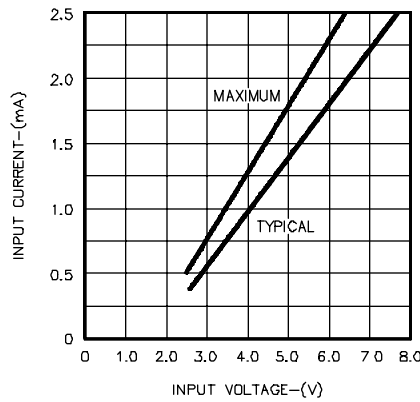

FIGURE 5. INPUT CHARACTERISTICS - SG2003

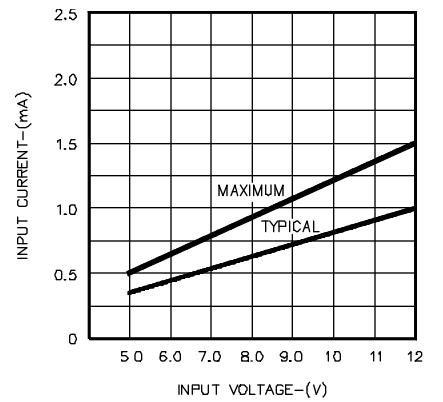

FIGURE 6. INPUT CHARACTERISTICS - SG2004

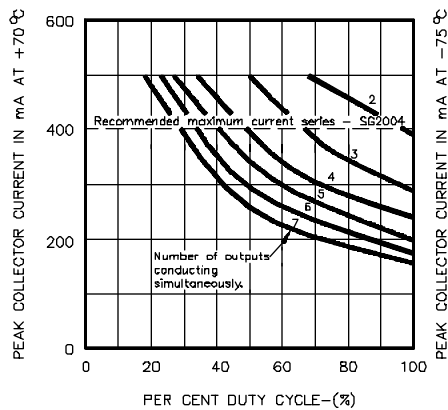

FIGURE 7. PEAK COLLECTOR CURRENT VS. DUTY CYCLE

CONNECTION DIAGRAMS & ORDERING INFORMATION (See Notes Below)

Package	Part No. (Note 3)	Ambient Temperature Range	Connection Diagram
16-PIN CERAMIC DIP J - PACKAGE	SG2XXXJ/883B SG2023J/DESC JAN2001J JAN2002J JAN2003J JAN2004J SG2XXXJ	-55°C to 125°C -55°C to 125°C -55°C to 125°C -55°C to 125°C -55°C to 125°C -55°C to 125°C -55°C to 125°C	
16-PIN PLASTIC DIP N - PACKAGE	SG2003N SG2023N	0°C to 70°C 0°C to 70°C	<p>N Package: RoHS Compliant / Pb-free Transition DC: 0503 N Package: RoHS / Pb-free 100% Matte Tin Lead Finish</p>
20-PIN CERAMIC LEADLESS CHIP CARRIER L- PACKAGE	SG2XXXL/883B SG2XXXL	-55°C to 125°C -55°C to 125°C	

DW Package (Not Pictured) is 16-Pin Wide Body SOIC, same pinout as J package pictured above.
 DW Package: RoHS Compliant / Pb-free Transition DC: 0516
 DW Package: RoHS / Pb-free 100% Matte Tin Lead Finish

- Note 1. Contact factory for JAN and DESC product availability.
 2. All parts are viewed from the top.
 3. See selection guide for specific device types.