

ZXMN0545G4

450V N-CHANNEL ENHANCEMENT MODE MOSFET

SUMMARY

$V_{(BR)DSS} = 450V$; $R_{DS(ON)} = 50\Omega$; $I_D = 140mA$

DESCRIPTION

This 450V enhancement mode N-channel MOSFET provides users with a competitive specification offering efficient power handling capability, high impedance and is free from thermal runaway and thermally induced secondary breakdown. Applications benefiting from this device include a variety of Telecom and general high voltage circuits.

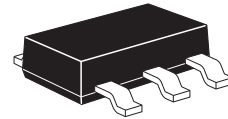

SOT223

FEATURES

- High voltage
- Low on-resistance
- Fast switching speed
- Low gate drive
- Low threshold
- SOT223 package variant engineered to increase spacing between high voltage pins

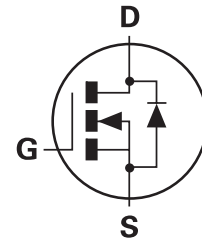

APPLICATIONS

- Off-line power supply start-up circuitry

ORDERING INFORMATION

DEVICE	REEL SIZE (inches)	TAPE WIDTH (mm)	QUANTITY PER REEL
ZXMN0545G4TA	7	12mm embossed	1,000 units
ZXMN0545G4TC	13	12mm embossed	4,000 units

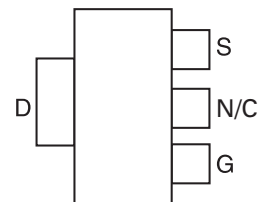

PINOUT - TOP VIEW

DEVICE MARKING

ZXMN
0545

ZXMN0545G4

ABSOLUTE MAXIMUM RATINGS

PARAMETER	SYMBOL	VALUE	UNIT
Drain-Source Voltage	V_{DS}	450	V
Gate Source Voltage	V_{GS}	± 20	V
Continuous Drain Current ($V_{GS}=10V$; $T_{amb}=25^{\circ}C$) ^(a)	I_D	140	mA
Pulsed Drain Current ^(c)	I_{DM}	600	mA
Continuous Source Current (Body Diode) ^(b)	I_S	140	A
Pulsed Source Current (Body Diode) ^(c)	I_{SM}	600	A
Power Dissipation at $T_{amb}=25^{\circ}C$ ^(a)	P_{tot}	2.0	W
Linear derating factor		1.6	mW/ $^{\circ}C$

THERMAL RESISTANCE

PARAMETER	SYMBOL	VALUE	UNIT
Junction to Ambient ^(a)	$R_{\theta JA}$	62.5	$^{\circ}C/W$
Junction to Ambient ^(b)	$R_{\theta JA}$	32	$^{\circ}C/W$

NOTES:

(a) For a device surface mounted on 25mm x 25mm FR4 PCB with high coverage of single sided 1oz copper, in still air conditions

(b) For a device surface mounted on FR4 PCB measured at $t \leq 5$ secs.

(c) Repetitive rating - pulse width limited by maximum junction temperature. Refer to Transient Thermal Impedance graph.

ZXMN0545G4

ELECTRICAL CHARACTERISTICS (at $T_{amb} = 25^{\circ}\text{C}$ unless otherwise stated)

PARAMETER	SYMBOL	MIN.	MAX.	UNIT	CONDITIONS
Drain-Source Breakdown Voltage	BV_{DSS}	450		V	$I_D=1\text{mA}$, $V_{GS}=0\text{V}$
Gate-Source Threshold Voltage	$V_{GS(th)}$	1	3	V	$I_D=1\text{mA}$, $V_{DS}=V_{GS}$
Gate-Body Leakage	I_{GSS}		20	nA	$V_{GS} = \pm 20\text{V}$, $V_{DS}=0\text{V}$
Zero Gate Voltage Drain Current	I_{DSS}		10 400	μA μA	$V_{DS}=450\text{V}$, $V_{GS}=0\text{V}$ $V_{DS}=405\text{V}$, $V_{GS}=0\text{V}$, $T=125^{\circ}\text{C}$ (2)
On-State Drain Current ⁽¹⁾	$I_{D(on)}$	150		mA	$V_{DS}=25\text{V}$, $V_{GS}=10\text{V}$
Static Drain-Source On-State Resistance ⁽¹⁾	$R_{DS(on)}$		50	Ω	$V_{GS}=10\text{V}$, $I_D=100\text{mA}$
Forward Transconductance ⁽¹⁾⁽²⁾	g_{fs}	100		mS	$V_{DS}=25\text{V}$, $I_D=100\text{mA}$
Input Capacitance ⁽²⁾	C_{iss}		70	pF	$V_{DS}=25\text{V}$, $V_{GS}=0\text{V}$, $f=1\text{MHz}$
Common Source Output Capacitance ⁽²⁾	C_{oss}		10	pF	
Reverse Transfer Capacitance ⁽²⁾	C_{rss}		4	pF	
Turn-On Delay Time ⁽²⁾⁽³⁾	$t_{d(on)}$		7	ns	$V_{DD}=25\text{V}$, $I_D=100\text{mA}$
Rise Time ⁽²⁾⁽³⁾	t_r		7	ns	
Turn-Off Delay Time ⁽²⁾⁽³⁾	$t_{d(off)}$		16	ns	
Fall Time ⁽²⁾⁽³⁾	t_f		10	ns	

(1) Measured under pulsed conditions. Width=300 μs . Duty cycle $\leq 2\%$

(2) Sample test.

(3) Switching times measured with 50 Ω source impedance and <5ns rise time on a pulse generator

ZXMN0545G4

TYPICAL CHARACTERISTICS

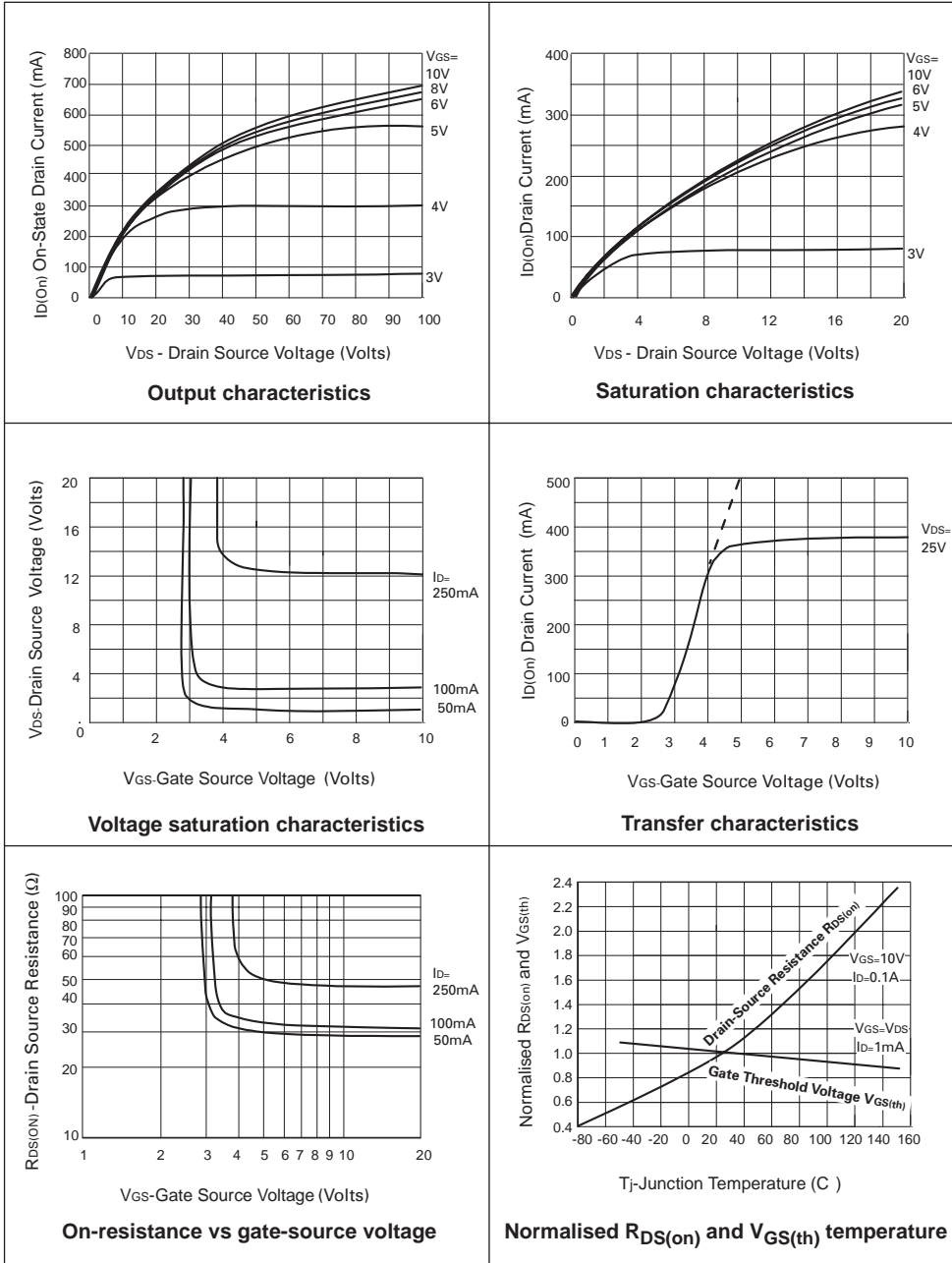

ZXMN0545G4

TYPICAL CHARACTERISTICS

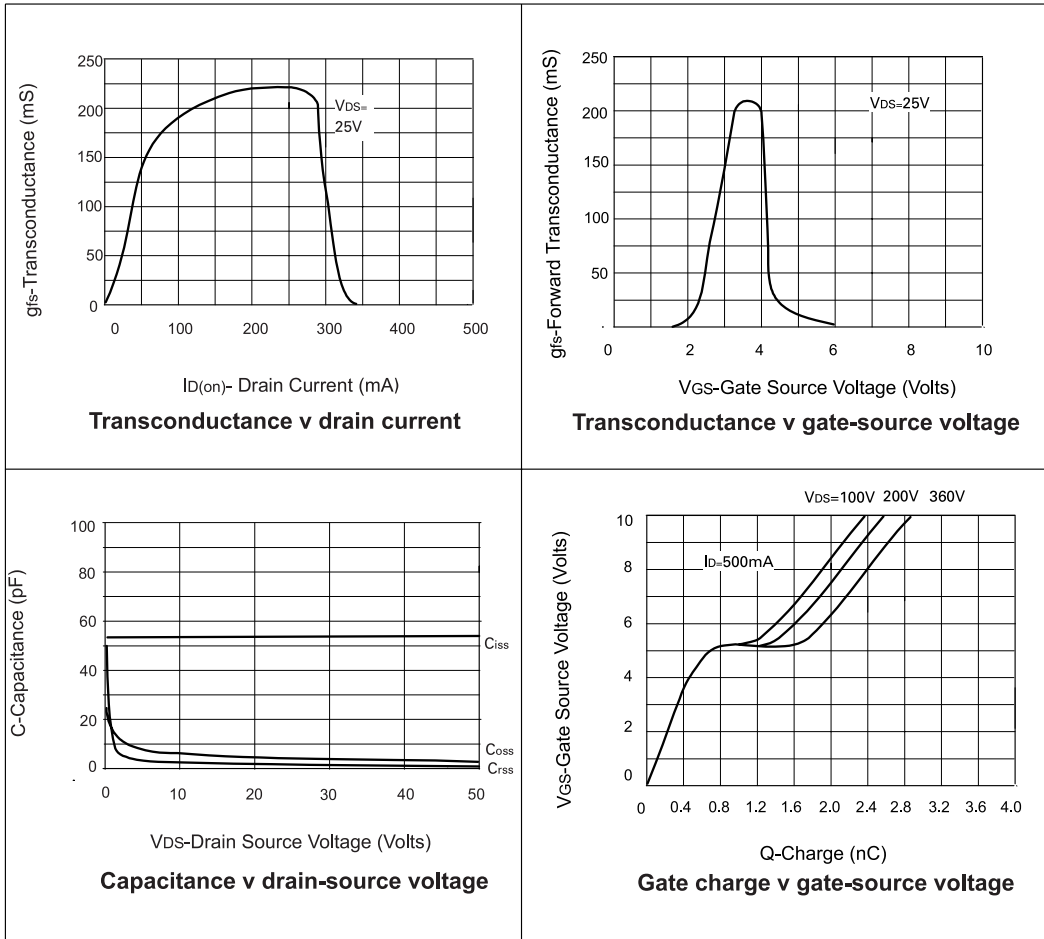

ZXMN0545G4

PACKAGE OUTLINE

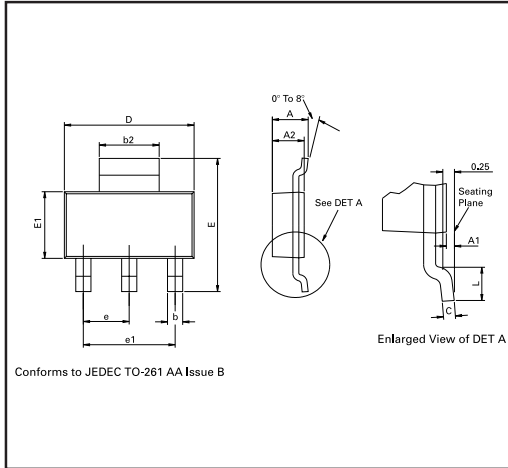

PAD LAYOUT DETAILS

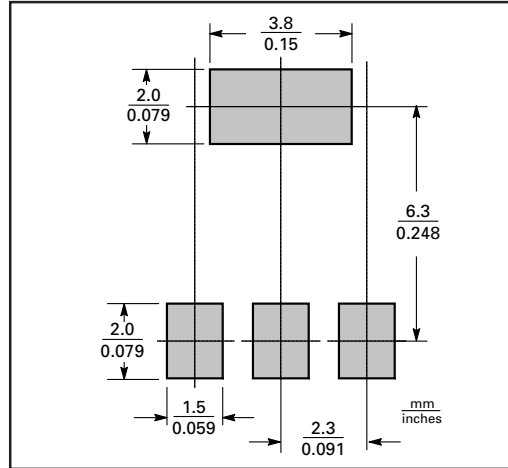

Controlling dimensions are in millimeters. Approximate conversions are given in inches

PACKAGE DIMENSIONS

DIM	Millimeters		Inches		DIM	Millimeters		Inches	
	Min	Max	Min	Max		Min	Max	Min	Max
A	-	1.80	-	0.071	e	2.30 BSC		0.0905 BSC	
A1	0.02	0.10	0.0008	0.004	e1	4.60 BSC		0.181 BSC	
b	0.66	0.84	0.026	0.033	E	6.70	7.30	0.264	0.287
b2	2.90	3.10	0.114	0.122	E1	3.30	3.70	0.130	0.146
C	0.23	0.33	0.009	0.013	L	0.90	-	0.355	-
D	6.30	6.70	0.248	0.264	-	-	-	-	-

© Zetex Semiconductors plc 2006

Europe	Americas	Asia Pacific	Corporate Headquarters
Zetex GmbH Streitfeldstraße 19 D-81673 München Germany	Zetex Inc 700 Veterans Memorial Hwy Hauppauge, NY 11788 USA	Zetex (Asia) Ltd 3701-04 Metroplaza Tower 1 Hing Fong Road, Kwai Fong Hong Kong	Zetex Semiconductors plc Zetex Technology Park Chadderton, Oldham, OL9 9LL United Kingdom
Telefon: (49) 89 45 49 49 0 Fax: (49) 89 45 49 49 49 europa.sales@zetex.com	Telephone: (1) 631 360 2222 Fax: (1) 631 360 8222 usa.sales@zetex.com	Telephone: (852) 26100 611 Fax: (852) 24250 494 asia.sales@zetex.com	Telephone (44) 161 622 4444 Fax: (44) 161 622 4446 hq@zetex.com

For international sales offices visit www.zetex.com/offices

Zetex products are distributed worldwide. For details, see www.zetex.com/salesnetwork

This publication is issued to provide outline information only which (unless agreed by the Company in writing) may not be used, applied or reproduced for any purpose or form part of any order or contract or be regarded as a representation relating to the products or services concerned. The Company reserves the right to alter without notice the specification, design, price or conditions of supply of any product or service.



ISSUE 1 - JANUARY 2006